

RADIO
Handbook
ELEVENTH EDITION

THE RADIO HANDBOOK

ELEVENTH EDITION

by

Editors and Engineers
LIMITED

R. L. DAWLEY

Editor

Associates:

G. M. KINGMAN
G. M. GRENING
W. F. PFEIFFER
B. A. ONTIVEROS (*Drafting*)

Assistants and Contributors:

R. L. NORTON
E. H. CONKLIN
F. R. GONSETT
A. McMULLEN
K. V. R. LANSINGH

Consultant:

WALTER W. SMITH

PUBLISHED AND DISTRIBUTED BY

EDITORS AND ENGINEERS, LTD.

1300 KENWOOD ROAD, SANTA BARBARA, CALIFORNIA, U.S.A.

(This book is revised and brought up to date at frequent intervals)

THE RADIO HANDBOOK

ELEVENTH EDITION

COPYRIGHT, 1947, BY

EDITORS AND ENGINEERS, LTD.

1300 KENWOOD ROAD, SANTA BARBARA, CALIFORNIA, U.S.A.

COPYRIGHT SECURED UNDER PAN-AMERICAN CONVENTION
ALL TRANSLATION RIGHTS RESERVED

(Acknowledgment is due to the American Telephone and Telegraph Company, the Radio Corporation of America, P. R. Mallory and Company, and Sylvania Electric Products, Inc., for data used in the compilation of reference material.)

PRINTED IN U. S. A. BY THE KABLE BROTHERS COMPANY

THE RADIO HANDBOOK

Table of Contents

Part I. Fundamentals and Reference Data

Chapter 1. Introduction to Radio.....	7
Chapter 2. Fundamentals of Electricity and Radio.....	14
2-1 Fundamental Electrical Units and Relationships.....	14
2-2 Electromagnetism	20
2-3 Alternating Current.....	21
2-4 Inductance	24
2-5 Electrostatic Storage of Energy.....	25
2-6 Circuits Containing Reactance and Resistance.....	28
2-7 Resonant Circuits.....	30
2-8 Transformers	33
2-9 Electric Filters.....	33
Chapter 3. Vacuum-Tube Principles.....	35
3-1 Cathodes	35
3-2 Other Electrodes.....	36
3-3 Types of Vacuum Tubes.....	37
Chapter 4. Vacuum-Tube Amplifiers.....	43
4-1 Vacuum-Tube Constants.....	43
4-2 R-C Coupled Audio-Frequency Amplifiers.....	45
4-3 Other Interstage Coupling Methods.....	47
4-4 Phase Inverters.....	49
4-5 Single-Ended Triode Audio-Frequency Amplifiers.....	50
4-6 Single-Ended Tetrode or Pentode Audio Amplifiers.....	50
4-7 Push-Pull Class A and Class AB Audio Stages.....	51
4-8 Class B Audio-Frequency Power Amplifiers.....	51
4-9 Cathode-Follower Power Amplifiers.....	54
4-10 Grid-Circuit Considerations.....	56
4-11 Plate-Circuit Considerations.....	57
4-12 Class C R-F Power Amplifiers.....	58
4-13 Class B R-F Power Amplifiers.....	62
4-14 Special R-F Power Amplifier Circuits.....	62
4-15 Feedback Amplifiers.....	64
4-16 Video-Frequency Amplifiers.....	65
Chapter 5. Radio Receiver Fundamentals.....	66
5-1 Detection or Demodulation.....	66
5-2 Superregenerative Receivers.....	67
5-3 Superheterodyne Receivers.....	68
5-4 Mixer Noise and Images.....	72
5-5 Signal-Frequency Tuned Circuits.....	73
5-6 Intermediate-Frequency Tuned Circuits.....	77
5-7 Detector, Audio, and Control Circuits.....	80
5-8 Noise Suppression.....	82
5-9 Special Considerations in V-H-F Receiver Design.....	84
5-10 Receiver Adjustment.....	88
Chapter 6. Generation of Radio-Frequency Energy.....	90
6-1 Self-Controlled Oscillators.....	90
6-2 Quartz-Crystal Oscillators.....	93
6-3 Crystal Oscillator Circuits.....	95
6-4 Radio-Frequency Amplifiers.....	96
6-5 Neutralization of R-F Amplifiers.....	97
6-6 Neutralizing Procedure.....	99
6-7 Grounded-Grid Amplifiers.....	101
6-8 Frequency Multipliers.....	101
6-9 Tank-Circuit Capacitances.....	103
6-10 Tuning Capacitor Air Gap.....	106
6-11 Parasitic Oscillation in R-F Amplifiers.....	107
6-12 Grid Bias Considerations.....	108
6-13 Interstage Coupling Methods.....	109
6-14 Radio-Frequency Chokes.....	110
6-15 Parallel and Push-Pull Circuits.....	110
6-16 Special Considerations for V-H-F and U-H-F.....	111
Chapter 7. Amplitude Modulation and Keying.....	113
7-1 Systems of Amplitude Modulation.....	115
7-2 Microphones	124
7-3 Speech Amplifiers.....	127
7-4 Speech Clipping.....	131
7-5 Transmitter Keying Methods.....	136
Chapter 8. Frequency Modulation.....	139
8-1 Frequency-Modulation Circuits.....	141
8-2 Phase Modulation.....	144
8-3 Frequency-Modulation Reception.....	146
Chapter 9. Transmitter Design and Control Principles.....	150
9-1 Exciters and Amplifiers.....	150
9-2 Design Considerations.....	151
9-3 Transmitter Control Methods.....	154
9-4 Safety Precautions.....	155
Chapter 10. Transmitter Adjustment.....	158
10-1 Initial Transmitter Tune-Up.....	158
10-2 Amplifier Adjustment.....	160
10-3 Elimination of Parasitic Oscillations.....	161
10-4 Coupling to the Antenna.....	162
10-5 Suppression of Harmonic Radiation.....	165
Chapter 11. Radiation and Propagation.....	167
11-1 Radiation from an Antenna.....	167
11-2 Propagation of Radio Waves.....	168
11-3 Ionospheric Propagation.....	170

Chapter 12. Principles of Antennas and Transmission Lines.....		172
12-1	General Characteristics of Antennas.....	172
12-2	Frequency and Antenna Length.....	172
12-3	Radiation Resistance and Feed-Point Impedance.....	174
12-4	Horizontal Directivity.....	175
12-5	Vertical Directivity.....	176
12-6	Bandwidth.....	177
12-7	General Types of Antennas and Arrays.....	178
12-8	Direct Feeding of the Antenna.....	178
12-9	Untuned Transmission Lines.....	179
12-10	Construction of Two-Wire Open Lines.....	180
12-11	Tuned or Resonant Lines.....	182
12-12	Matching Non-Resonant Lines to the Antenna.....	182
12-13	Matching Stubs.....	184
12-14	Linear R-F Transformers.....	186
12-15	Receiving Antennas.....	188
12-16	Loop Antennas.....	189
Chapter 13. Workshop Practice.....		190
13-1	Types of Construction.....	190
13-2	Tools.....	191
13-3	Construction Practice.....	192
Chapter 14. Broadcast Interference.....		195
14-1	Interference Classifications.....	195
14-2	Superheterodyne Interference.....	199
Chapter 15. Reference Data.....		201
Chapter 16. Radio Receiving-Tube Characteristics.....		205
Chapter 17. Transmitting-Tube Characteristics.....		245
Part II. Construction of Radio Equipment		
Chapter 18. High-Frequency Receiver Construction.....		268
Chapter 19. Converters for the 28-Mc. and 50-Mc. Bands.....		276
Chapter 20. V-H-F and U-H-F Receiver Construction.....		282
Chapter 21. H-F Exciters and Low-Power Transmitters.....		287
Chapter 22. High-Frequency Power Amplifiers.....		305
Chapter 23. V-H-F and U-H-F Transmitters.....		319
Chapter 24. Speech and Amplitude-Modulation Equipment.....		333
Chapter 25. Power Supplies.....		342
25-1	Rectification.....	342
25-2	Filter-Circuit Considerations.....	345
25-3	Special Power Supplies.....	347
25-4	Transformer Design.....	352
25-5	Filter Choke Considerations.....	356
25-6	Power Supply Construction.....	357
Chapter 26. Transmitter Construction.....		361
Part III. Antenna Construction and Adjustment		
Chapter 27. Lower Frequency Antennas.....		373
27-1	End-Fed Half-Wave Horizontal Antennas.....	373
27-2	Center-Fed Half-Wave Horizontal Antennas.....	375
27-3	Half-Wave Vertical Antennas.....	376
27-4	The Marconi Antenna.....	376
27-5	Space-Conserving Antennas.....	378
27-6	Multi-Band Antennas.....	379
27-7	Antenna Construction.....	381
27-8	Dummy Antennas.....	383
Chapter 28. High-Frequency Directive Antenna Arrays.....		384
28-1	Long-Wire Radiators.....	385
28-2	The "V" Antenna.....	386
28-3	The Rhombic Antenna.....	387
28-4	Stacked-Dipole Arrays.....	388
28-5	Broadside Arrays.....	390
28-6	End-Fire Directivity.....	390
Chapter 29. V-H-F and U-H-F Antennas.....		394
29-1	Antenna Requirements.....	394
29-2	Horizontally-Polarized Arrays.....	396
29-3	Vertically-Polarized Antennas and Arrays.....	397
29-4	The Corner-Reflector Antenna.....	399
29-5	V-H-F Mobile Antennas.....	400
Chapter 30. Rotatable Antenna Arrays.....		401
30-1	"Three-Element-Rotary" Type Arrays.....	401
30-2	Feed Systems for Parasitic End-Fire Arrays.....	403
30-3	Unidirectional Stacked Broadside Arrays.....	405
30-4	Bi-Directional Rotatable Arrays.....	406
30-5	Construction of Rotatable Arrays.....	406
30-6	Tuning the Antenna Array.....	409
30-7	Systems for Obtaining Rotation.....	414
Part IV. General		
Chapter 31. Test and Measurement Equipment.....		415
31-1	Voltage, Current, and Power.....	415
31-2	Measurement of Circuit Constants.....	419
31-3	Frequency Measurements.....	421
31-4	Construction of Monitoring and Test Equipment.....	424
Chapter 32. Conversion of Surplus Military Equipment.....		431
Table of "Q" Signals.....		448
Index.....		509

BOOKS ON RADIO AND ALLIED SUBJECTS

A well-chosen if small library of good books is a necessity to any radioman. It is better to study carefully and thoroughly a few books than to be superficially acquainted with a number of them.

Selections from the texts which we can recommend are described below. We carry in stock at all times nearly every current-available radio book; send stamp for our catalog.

ELEMENTARY THEORY

FUNDAMENTALS OF RADIO, by F. E. Terman. A first book and also a good refresher for all radio students and workers. This text has been widely used in civilian and military classes. Requires no knowledge of complex mathematics. 458 pages. Book No. TF10 \$4.00*

PRINCIPLES OF RADIO, by Keith Henney. A basic course in radio which may readily be comprehended by high-school or trade-school students and may be used in independent home study. Well illustrated. 534 pages. Book No. HP20 \$3.75*

BASIC ELECTRICITY FOR COMMUNICATIONS, by W. H. Timbie. A student wishing a sound grounding in electrical fundamentals before undertaking the study of communications, and the communications student or worker requiring a reference book or refresher course in electricity will find Timbie admirably suited to the need. The few mathematical applications, which never go beyond simple algebra, are completely explained in this book. A summary follows each chapter, and well chosen problems are offered to test the student's learning and to give practice in applying electrical principles. 603 pages. Book No. TB20 \$3.75*

RADIO PHYSICS COURSE, by A. A. Ghirardi. Basic fundamentals of electricity, radio, television and sound especially adapted to home instruction; a minimum of mathematics; contains many self-review questions. Covers every branch of radio, including broadcasting, servicing, aviation, marine, police, military, public address, and electronics applications. 972 pages. Book No. GP60 \$5.00*

UNDERSTANDING RADIO, by H. M. Watson. A high-school type textbook and laboratory manual for either resident or home study. This book is distinguished by its picture layout and step-by-step instructions. 601 pages. Book No. WU10 \$2.80*

ELECTRONICS FOR RADIO MAN AND ELECTRICIAN, Coyne. The simplified book on Electronics, field of the future! For Radio Men, Electricians and all interested in practical electronics, hundreds of illustrations. Includes thyratron, pilotron, kenotron, ignitron, phototubes and others. 400 pages. Book No. CE80 \$3.75*

ELEMENTS OF RADIO, by A. & W. Marcus. An extensive course prepared for those without previous training in mathematics or physics; particularly recommended for premilitary training; one of the best for this purpose. Particularly good for home study, to obtain basic groundwork for jobs in radio industry. 699 pages. Book No. ME80 \$4.00*

RADIO: FUNDAMENTAL PRINCIPLES AND PRACTICE, by F. E. Almstead, K. E. Davis and G. K. Stone. A relatively simple "intermediate" textbook, designed to bridge the gap between the elementary and advanced phases of radio study. 219 pages. Book No. AP10 \$2.20*

INTERMEDIATE AND ADVANCED THEORY AND ENGINEERING

RADIO ENGINEERING, by F. E. Terman. Probably the most popular foundation engineering textbook for all serious radio courses and libraries. Thoroughly revised. 813 pages. Book No. TE10 \$6.00*

ENGINEERING ELECTRONICS, by D. G. Fink. Using clear language and the absolute minimum of elementary mathematics, this book covers atomic and electronic theory, vacuum- and gaseous-tube circuit operation, photo-cells, cathode ray tubes, x-rays, television tubes, the electron microscope, electronic production of light, tube circuits for power, communication, and industrial control applications, and electronic measurements. 358 pages. Book No. FE10 \$4.00*

APPLIED ELECTRONICS, by M.I.T. Electrical Engineering Staff. A mathematical treatment of elec-

tronic theory with special emphasis on applications to communications circuits. This book is very complete and will be invaluable to the advanced student or practicing engineer. 772 pages. Book No. ME20 \$6.50*

ELECTRONICS FOR ENGINEERS, by John Markus and Vincent Zeluff. This unique book condenses much invaluable electronic engineering data into graphs, charts, tables, and concise articles. In this way, it shortcuts the looking up of information. The tool value of this book is tremendous. 390 pages. Book No. ME11 \$6.00*

ELECTRONICS, by J. Millman and S. Seely. An engineering presentation of the subject, from first principles to control circuits. The student using this book must have a knowledge of calculus and college physics. 721 pages. Book No. ME10 \$5.50*

RADIO RECEIVER DESIGN (Part I), by K. R. Sturley. This is an English-authored book of especial interest to receiver engineers. Part I covers in detail the stage-by-stage design aspects of the receiver section between antenna and detector. Unique, excellent; highly mathematical. 435 pages. Book No. SD20 \$5.00*

ELECTRON TUBES AND Industrial Electronics

THE WORLD'S RADIO TUBES (Radio Tube Vade Mecum), by P. H. Brans. More than 10,000 tubes listed, the only book of its kind in the world. Contains, in twelve languages, characteristic tube data of U.S., British, French, Czech, Swiss, Australian, Scandinavian, German, Italian, Russian, Japanese, and all other available types. "Here at last is the Radio Tube Handbook which radio engineers have dreamed of," says "Electronics." Book No. BT80 \$3.00 list price; \$3.10 U.S.A. postpaid, \$3.20 Foreign postpaid.

THEORY AND APPLICATION OF ELECTRON TUBES, by H. J. Reich. The fundamentals of electron tubes and tube circuits. This well-known text has been revised and includes such modern topics as pulse generation. An excellent book for the communications man who wants to be well informed on tubes. 670 pages. Book No. RT10 \$5.50*

ELECTRON TUBES IN INDUSTRY, by Keith Henney. This book, rich in industrial applications and explanatory theory, was written expressly for the industrial engineer and technician. It reviews electrical, tube, and circuit theory and describes numerous electronic devices which have been tried and proven in various electrical and non-electrical industries. 539 pages. Book No. HT10 \$5.50*

FUNDAMENTALS OF VACUUM TUBES, by A. V. Eastman. A technical work on high-vacuum, mercury-vapor, and photoelectric type tubes. Contains mathematical theory of tube action in detector, amplifier, oscillator, and control circuits. Groundwork is required in basic college mathematics and physics in order to use this book profitably. 584 pages. Book No. EF10 \$5.00*

ELECTRONICS IN INDUSTRY, by G. M. Chute. A non-technical treatment of the subject for the industrial technician or executive. Electron-tube applications in numerous industries are described. Concise, meaty explanations are augmented by well-chosen diagrams. 403 pages. Book No. CE10 \$5.00*

ELECTRONICS FOR INDUSTRY, by W. I. Bendz. A practical, thoroughly illustrated, non-mathematical discussion of the functions of all types of electronic tubes, and the principles of basic circuits used with many industrial devices. 501 pages. Book No. BE20 \$5.00*

FUNDAMENTALS OF INDUSTRIAL ELECTRONIC CIRCUITS, by Walter Richter. Excellent "intermediate" book. Text is "meaty," terse, understandable, well organized. Ideal for 15-min.-a-day supervised study. 567 pages. Book No. RC10 \$4.50*

INDUSTRIAL ELECTRONIC CONTROL, by W. D. Cockrell. Industrial electronics explained especially for the electrical worker who must install and maintain electronic equipment in factories, offices and homes. The electrician, factory or office executive, and salesman, may gain a quick understanding of basic electronic principles and of related equipment from a study of this book. 247 pages. Book No. CC10 \$2.75*

AUDEL'S ELECTRONIC DEVICES. An unusually simple treatment of electronic and photoelectric tubes particularly for non-radio uses such as candle-power and color determination, electric counters and controls, "electric eyes," sound reproduction and the like. 206 pages. Book No. AE80 \$2.00*

PHOTOCELLS AND THEIR APPLICATIONS, by V. K. Zworykin and E. D. Wilson. This book will be invaluable to all persons who work with photocells or expect to. The style is lucid, and numerous industrial and scientific applications of the electric eye are described. 348 pages. Book No. ZP20 \$3.50*

HIGH-FREQUENCY INDUCTION HEATING, by F. W. Curtis. Fundamentals of induction heating for hardening metal parts, joining metal assemblies, brazing, soldering, etc. Many industrial applications; detailed procedures; fixture design and process handling equipment. 231 pages. Book No. CH10, \$3.00*

RADIO MATHEMATICS

MATHEMATICS FOR ELECTRICIANS AND RADIO-MEN, by N. M. Cooke. This book presents all of the mathematics needed for a clear understanding of a.c., d.c., and high-frequency circuits and of electron tube operation. The text material covers the entire subject from simple arithmetic to logarithms, trigonometry, and vectors. It is an excellent book for the radioman who wishes to prepare himself for a more rigorous mathematical course. A wealth of illustrative examples and problems demonstrate applications of mathematical processes and reasoning to radio circuit investigation. 604 pages. Book No. CM10 \$4.50*

APPLIED MATHEMATICS FOR RADIO AND COMMUNICATION ENGINEERS, by C. E. Smith. An accelerated and easy-reading, yet thorough, course in mathematics. Ideal for home study. 336 pages. Book No. SM10 \$3.50*

MATHEMATICS OF RADIO COMMUNICATION, by T. J. Wang. Similar to Book CM10 but without elementary arithmetic, and somewhat less extensive in scope. 371 pages. Book No. WM30 \$3.75*

ULTRA-HIGH FREQUENCIES

U.H.F. RADIO SIMPLIFIED, by Milton S. Kiver. U.h.f. radio simply and clearly explained, in plain English, without mathematics. Covers principles, applications, and equipment; adapted for home study. 242 pages. Book No. KU30 \$3.25*

INTRODUCTION TO MICROWAVES, by Simon Ramo. This book is unique in that it is a simple introduction to microwaves written in clear English and avoiding the use of mathematics altogether. 138 pages. Book No. RM10 \$2.00*

MICROWAVE TRANSMISSION, by J. C. Slater. A mathematical discussion of transmission lines and wave guides. The use of Maxwell's equations in transmission line design is described. 309 pages. Book No. SM11 \$4.00*

ULTRA HIGH FREQUENCY TECHNIQUES. This book by professors of electricity at four different universities explains the principles that lie specifically in the u.h.f. field; a thorough foundation for all u.h.f. work, including every step from linear circuit theory to transmission lines, radiation, propagation and wave guides. A series of experiments is also outlined to demonstrate the phenomena described. 534 pages. Book No. BU30 \$5.00*

(Continued on page 508)

*Add 3% (minimum, 10c) for postage and packing; foreign, 10%. In Ill. and Calif. add sales tax. Prices are in U.S. dollars, subject to change without notice.



**A TYPICAL
AMATEUR STATION**

THE NEAT "SHACK" AND 50-MC. BEAM OF W6FFF

Introduction to Radio

THE field of radio is a division of the much larger field of electronics. Radio itself is such a broad study that it is still further broken down into a number of smaller fields of which only shortwave or high-frequency radio is covered in this book. Specifically the field of communication on frequencies from 3.5 to 500 megacycles is taken as the subject matter for this work.

The largest group of persons interested in the subject of high-frequency communication is the more than 80,000 radio amateurs located in nearly all countries of the world. Strictly speaking a radio amateur is anyone interested in radio non-commercially, but the term is ordinarily applied only to those hobbyists possessing transmitting equipment and a license from the government.

It was for the radio amateur, and particularly for the serious amateur, that most of the material in this book was originally developed, particularly the equipment shown; however, in each equipment group simple items are also shown for the student and beginner. The principles of high-frequency radio are of course identical whether the equipment is used for commercial or non-commercial purposes; and the equipment differs little for either purpose, the principal difference being that commercial equipment is usually made to be as reliable as possible with less regard to cost while amateur equipment must often be constructed for as little cost as possible.

Amateur Radio Amateur Radio was suspended for the duration of the war, but as this book goes to press it has been substantially restored. It is a fascinating hobby with several phases. So strong is the fascination offered by this hobby that many executives, engineers, and operators enjoy amateur radio as an avocation even though they are also engaged in the radio field commercially. It captures and holds the interest of many people in all walks of life, and in all countries of the world where amateur activities are permitted by law.

Although amateur radio is considered "only a hobby" by the general public, its history contains countless incidents of technical achievement, particularly in the now widely used high frequencies which were developed by amateurs while

engineers still considered them generally useless. The old adage that necessity is the mother of invention has been more than true in amateur radio, for the average amateur has limited funds which he can afford to devote to his hobby, and many an attempt to do something more cheaply has also resulted in doing it better.

Amateurs are a fraternal lot; their common interest makes them "brothers under the skin." When visiting strange towns an amateur often looks up friends with whom he has become acquainted over the air; even if he knows no amateurs in a given vicinity his amateur call usually makes him more than welcome. Amateur radio clubs have been formed all over the country; meetings feature both elementary and advanced technical talks, study sessions and code classes, social contacts, and "eats." Veteran amateurs met at such meetings will "give a hand" to the newcomer; among those met at club meetings will usually be found some other newcomers, one of whom should be selected if possible as a study companion; such a companion is particularly useful when it comes to learning the radio code.

Amateurs have rendered much public service through furnishing communications to and from the outside world in cases where disaster has isolated an area by severing all wire communications. Amateurs have a proud record of heroism and service in such occasion. Many expeditions to remote places have been kept in touch with home by communication with amateur stations on the high frequencies. The amateur's fine record of performance with the "wireless" equipment of World War I has been surpassed by his outstanding service in World War II. By the time peace came in the Pacific in the summer of 1945, many thousand former amateur operators were serving in the allied armed forces. They had supplied the army, navy, marines, coast guard, merchant marine, civil service, war plants, and civilian defense organizations with *trained* personnel for radio, radar, wire, and visual communications and for teaching.

Some amateurs revel in contacts with far-distant countries; these are called "dx" men. Others specialize in relaying messages. Some are tireless experimenters, getting as much pleasure from building, improving, and tearing down equipment as

A	••••	N	••••	1	••••••••
B	••••••	O	••••••	2	••••••••
C	•••••••	P	•••••••	3	••••••••
D	•••••	Q	••••••••	4	•••••••
E	••••	R	•••••	5	•••••••
F	••••••	S	••••••	6	••••••••
G	•••••••	T	•••••	7	••••••••
H	•••••••	U	••••••	8	••••••••
I	•••••	V	•••••••	9	•••••••••
J	••••••••	W	••••••••	Ø	••••••••••
K	••••••••	X	••••••••	Ø MEANS ZERO, AND IS WRITTEN IN THIS WAY TO DISTINGUISH IT FROM THE LETTER "O". IT OFTEN IS TRANSMITTED INSTEAD AS ONE LONG DASH (EQUIVALENT TO 5 DOTS)	
L	••••••••	Y	•••••••••		
M	••••••••	Z	•••••••••		
PERIOD (.)	•••••••••	WAIT SIGN (AS)	•••••••••		
COMMA (,)	••••••••••	DOUBLE DASH (BREAK)	••••••••••		
INTERROGATION (?)	••••••••••	ERROR (ERASE SIGN)	•••••••••••		
QUOTATION MARK (")	••••••••••	FRACTION BAR (/)	••••••••••		
COLON (:)	•••••••••••	END OF MESSAGE (AR)	••••••••••		
SEMICOLON (;)	•••••••••••	END OF TRANSMISSION (SK)	•••••••••••		
PARENTHESIS ()	•••••••••••	INTERNAT. DISTRESS SIG. (SOS)	•••••••••••••		

Figure 1.

The continental (or International Morse) Code is used for all radio communications. DO NOT memorize from the printed page; code is a language of SOUND, and must not be learned visually; learn by listening as explained in the text.

from actual operation on the air. Others prefer not to specialize, but simply to "chew the rag" with any other amateur whom they may happen to contact on the air.

Amateurs often refer to themselves as "hams"; the origin of this slang term is obscure, but its use is well-established; it does not imply poor ability or worse as in the phrase "ham actor"; in fact many hams are also prominent radio engineers in their working hours.

Station and Operator Licenses Every radio transmitting station in the United States no matter how low its power must have a license from the federal government before being operated; some classes of stations must have a permit from the government before even being constructed. And every operator of a transmitting station must have an operator's license before operating a transmitter. There are no exceptions. Similar laws apply in practically every major country.

To secure an amateur operator's license from the Federal Communications Commission, you must be a citizen of the U.S.A., master the radio code, know how amateur transmitters and receivers work and how they must be adjusted, and be familiar with the laws and regulations pertaining to amateur operators and stations. Examinations consist of a written theoretical examination and a code test; the required code speed is 13 words per minute, both sending and receiving.

Starting Your Study When you start to prepare yourself for the amateur or other examination you will find that the circuit diagrams, tube characteristic curves, and formulas appear confusing and difficult of understanding. But after a few study sessions one becomes sufficiently familiar with the notation of the diagrams and the basic concepts of theory and operation so that the acquisition of further knowledge becomes easier and even fascinating.

As it takes considerable time to become proficient in sending and receiving code, it is a good idea to intersperse technical study sessions with periods of code practice. Many short code practice sessions benefit one more than a fewer number of longer sessions. Alternating between one study and the other keeps the student from getting "stale" since each type of study serves as a sort of respite from the other.

When you have practiced the code long enough you will be able to follow the gist of the slower sending stations. Many stations send very slowly when working other stations at great distances. Stations repeat their calls many times when calling other stations before contact is established, and one need not have achieved much code proficiency to make out their calls and thus determine their location.

Granted that it is advisable to start in with learning the code, you will want to know how to go about mastering it in the shortest time with the least amount of effort.

The Code The applicant for an amateur license must be able to send and receive the Continental Code (sometimes called the International Morse Code) at a speed of 13 words per minute, with an average of five characters to the word. Thus 65 characters must be copied consecutively without error in one minute. Similarly 65 consecutive characters must be sent without error in the same time. Code tests usually last about five minutes; if 65 consecutive characters at the required rate are copied correctly anywhere during the five-minute period, the applicant is usually considered to have passed the test successfully.

A code speed of 16 words per minute is required for the lowest class of commercial radio operator's license. Higher classes require greater speeds.

If the code test is failed, the applicant must wait at least one month before he may again appear for another test. Approximately 30% of amateur applicants fail to pass the

test. It should be expected that nervousness and excitement will at least to some degree temporarily lower the applicant's code ability. The best prevention against this is to master the code at a little greater than the required speed under ordinary conditions. Then if you slow down a little due to nervousness during a test the result will not prove "fatal."

Memorizing the Code There is no shortcut to code proficiency. To memorize the alphabet entails but a few evenings of diligent application, but considerable time is required to build up speed. The exact time required depends upon the individual's ability and the regularity of practice.

While the speed of learning will naturally vary greatly with different individuals, about 70 hours of practice (no practice period to be over 30 minutes) will usually suffice to bring a speed of about 13 w.p.m.; 16 w.p.m. requires about 120 hours; 20 w.p.m., 175 hours.

Since code reading requires that individual letters be recognized instantly, any memorizing scheme which depends upon orderly sequence, such as learning all "dab" letters and all "dit" letters in separate groups, is to be discouraged. Before beginning with a code practice set it is necessary to memorize the whole alphabet perfectly. A good plan is to study only two or three letters a day and to drill with those letters until they become part of your consciousness. Mentally translate each day's letters into their sound equivalent wherever they are seen, on signs, in papers, indoors and outdoors. Tackle two additional letters in the code chart each day, at the same time reviewing the characters already learned.

Avoid memorizing by routine. Be able to sound out any letter immediately without so much as hesitating to think about the letters preceding or following the one in question. Know C, for example, apart from the sequence ABC. Skip about among all the characters learned, and before very long sufficient letters will have been acquired to enable you to spell out simple words to yourself in "dit dabs." This is interesting exercise, and for that reason it is good to memorize all the vowels first and the most common consonants next.

Actual code practice should start only when the entire alphabet, the numerals, period, comma, and question mark have been memorized so thoroughly that any one can be sounded without the slightest hesitation. Do not bother with other punctuation or miscellaneous signals until later.

Sound not Sight Each letter and figure *must* be memorized by its *sound* rather than its appearance. Code is a system of sound communication, the same as is the spoken word. The letter A, for example, is one short and one long sound in combination sounding like *dit dab*, and it must be remembered as such, and not as "dot dash."

As you listen to the sound of a letter transmitted slowly by an experienced operator, you will notice how closely the dots

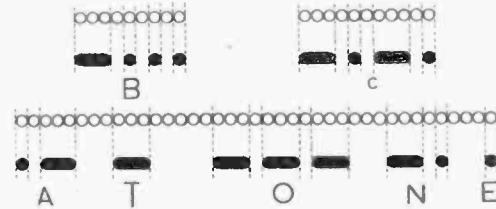

Figure 3. Diagram illustrating relative lengths of dashes and spaces referred to the duration of a dot. A dash is exactly equal in duration to three dots; spaces between parts of a letter equal one dot; those between letters, three dots; space between words, five dots. Note that a slight increase between two parts of a letter will make it sound like two letters.

resemble the sound *dit* and the dashes *dab*.

You must learn the individual sounds of each code signal so that you associate these *instantly* with the various specific characters for which they stand. If you attempt to learn by visualizing the dots and dashes, you will never be able to translate them into the characters for which they stand with any degree of speed, so avoid any visualization right from the start.

Practice Time, patience, and regularity are required to learn the code properly. Do not expect to accomplish it within a few days.

Don't practice too long at one stretch; it does more harm than good. Thirty minutes at a time should be the limit.

Lack of regularity in practice is the most common cause of lack of progress. Irregular practice is very little better than no practice at all. Write down what you have heard; then forget it; *do not look back*. If your mind dwells even for an instant on a signal about which you have doubt, you will miss the next few characters while your attention is diverted.

Take it easy, do not become confused or nervous. Try to ignore the presence of other persons. If you find that they make you nervous, it is a good idea to ask some friends to stand near you and talk with each other while you are practicing. After a few sessions you will become accustomed to external sounds and they will bother you no more.

Each person can learn only so fast; do not try to exceed your natural rate or you will become overanxious and actually slow down your progress.

While various automatic code machines, phonograph records, etc., will give you practice, by far the best practice is to obtain a study companion who is also interested in learning the code. When you have both memorized the alphabet you can start sending to each other. Practice with a key and oscillator or key and buzzer generally proves superior to all automatic equipment. Two such sets operated between two rooms are fine—or between your house and his will be just that much better. Avoid talking to your partner while practicing. If you must ask him a question, do it in code. It makes more interesting practice than confining yourself to random practice material.

When two co-learners have memorized the code and are ready to start sending to each other for practice, it is a good idea to enlist the aid of an experienced operator for the first practice session or two so that they will get an idea of how properly formed characters sound.

When you are practicing with another beginner don't gloat if you seem to be learning to receive faster than he. It may be that his *sending* is better than yours. Remember that the quality of sending affects the maximum copying speed of a beginner to a very large degree. If the sending is bad enough, the newcomer won't be able to read it at all and even an old-

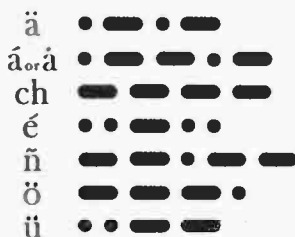

Figure 2. These foreign characters may occasionally be encountered so it is well to know them.

KYKXQ	? . . , ?	W6HAU	TNRME
LUDHW	KGATS	WQLAK
HSUSK	? ? . . ,	3V3V4	PGOFI
WKSOD	. . . ?	B6B67	ISUAT
WOSMF	12345	4V3B7	QBWNE
KJHGF	67890	5HS0*	RNTBY
ZQZYX	05647	W2ATF	OFUXY
OPGJU	28596	K6BZQ	YATSR
ASDFG	BWCMY	FA8G6	EVARNY
QWERT	W6ZMA	1*PM4	LQODT
ZXCVB	35476	45XVG	PSGRT
POIUY	00572	86QHK	W6DHG
LKJHG	72649	86QHC	SGWYF
MNBVC	99736	LKJ55	AODHR
QAZWS	26294	WMS76	W6BCX
XEDCR	93856	36Y94	FOSYT
KSYTR	22557	117GT	WNEYS
MNERT	37495	6SQ7G	W6FFF
FVTGB	55100	PZMXA	SUEHT
YHNUJ	10000	QMWNE	SGYOS
MUKIL	00009	RBTVY	W6CEM
PLOKM	26483	UXIZO	GAHEU
IJNUH	27385	ALSKD	AOEHT
BYVGT	28465	JFHGT	W6KFQ
FCRDY	37495	PZOXI	HSGEY
ESZWA	92220	CUVYB	SYSGE

Figure 4.

The above list of mixed character groups (similar to cipher codes) will be found to be excellent for practice; the succeeding characters cannot be guessed as when working from straight text.

timer may have trouble getting the general drift of what you are trying to say.

During the first practice period the speed should be such that substantially solid copy can be made without strain. Never mind if this is only two or three words per minute. In the next period the speed should be increased slightly to a point where nearly all of the characters can be caught only through conscious effort. When the student becomes proficient at this new speed, another slight increase may be made, progressing in this manner until a speed of about 16 words per minute is attained if the object is to pass the amateur 13-word per minute code test. The margin of 3 w.p.m. is recommended to overcome a possible excitement factor at examination time. Then when you take the test you don't have to worry about the "jitters" or an "off day."

Speed should not be increased to a new level until the student finally makes solid copy with ease for at least a five-minute period at the old level. How frequently increases of speed can be made depends upon individual ability and the amount of practice. Each increase is apt to prove disconcerting, but remember "you are never learning when you are comfortable."

A number of amateurs are sending code practice on the air on schedule once or twice each week; excellent practice can be obtained after you have bought or constructed your receiver by taking advantage of these sessions. A stamped, self-addressed envelope accompanying an inquiry to the American Radio Relay League, West Hartford, Connecticut,

will bring a list of the stations transmitting code practice in your vicinity.

If you live in a medium-size or large city, the chances are that there is an amateur radio club in your vicinity which offers free code practice classes periodically.

Practice At the start use plain English, sending from a book, newspaper, or anything handy. Also practice disconnected words from a newspaper or magazine, and the code groups given in Figure 4.

More detailed instructions on code learning and practice may be obtained from several textbooks which are written to cover this subject exhaustively.*

Skill When you listen to someone speaking you do not consciously think how his words are spelled. This is also true when you read. In code you must train your ears to read code just as your eyes were trained in school to read printed matter. With enough practice you acquire skill, and from skill, speed. In other words, it becomes a *habit*, something which can be done without conscious effort. Conscious effort is fatal to speed; we can't think rapidly enough; a speed of 25 words a minute, which is a common one in commercial operations, means 125 characters per minute or more than two per second, which leaves no time for conscious thinking.

Speed comes only through practice, and lots of it; however, as stated above, this does not mean long practice sessions, which are actually harmful.

Perfect Formation of Characters When transmitting on the code practice set to your partner, concentrate on the *quality* of your sending, *not* on your speed. Your partner will appreciate it and he could not copy you if you speeded up anyhow.

If you want to get a reputation as having an excellent "fist" on the air, just remember that speed alone won't do the trick. Proper execution of your letters and spacing will make much more of an impression. Fortunately, as you get so that you can send evenly and accurately, your sending speed will automatically increase. Remember to try to see how *evenly* you can *send*, and how *fast* you can *receive*. Concentrate on making signals properly with your key. Perfect formation of characters is paramount to everything else. Make every signal right no matter if you have to practice it hundreds or thousands of times. Never allow yourself to vary the slightest from perfect formation once you have learned it. Never mind how slowly you must send in order to be accurate. In the long run you will gain speed much more quickly if you have learned right, and you will never get much speed if you learn wrong. Everything else is secondary to perfection at this point.

If possible, get a good operator to listen to your sending for a short time, asking him to criticize even the slightest imperfections.

Timing It is of the utmost importance to maintain uniform spacing in characters and combinations of characters. Lack of uniformity at this point probably causes beginners more trouble than any other single factor. Every dot, every dash, and every space must be correctly timed. In other words, accurate timing is absolutely essential to intelligibility, and timing of the spaces between the dots and dashes is just as important as the lengths of the dots and dashes themselves.

*THE RADIO AMATEUR NEWCOMER, 160 pages, gives further information on code learning and in addition gives a complete list of study questions for the radio amateur operator license examination with reference data. A number of transmitters and receivers suitable for the beginner in amateur radio are described in detail. The price is \$1.00 from our book department (add tax in Calif.).

The characters are timed with the dot as a "yardstick." A standard dash is three times as long as a dot. The spacing between parts of the same letter is equal to one dot; the space between letters is equal to three dots, and that between words equal to five dots. There are *no such things* as long, medium, or short dashes; a dash must always equal the length of three dots, neither more nor less.

The rule for spacing between letters and words is not strictly observed when sending slower than about 10 words per minute for the benefit of someone learning the code and desiring receiving practice. When sending at, say, 5 w.p.m., the individual letters should be made the same as if the sending rate were about 10 w.p.m., except that the spacing between letters and words is greatly exaggerated. The reason for this is obvious. The letter *L*, for instance, will then sound exactly the same at 10 w.p.m. as at 5 w.p.m., and when the speed is increased above 5 w.p.m. the student will not have to become familiar with what may seem to him like a new sound, although it is in reality only a faster combination of dots and dashes. At the greater speed he will merely have to learn the identification of the *same* sound without taking as long to do so.

Experience has shown that it does not aid a student in identifying a letter by sending the individual components of the letter at a speed corresponding to less than 10 w.p.m. By sending the letter moderately fast a longer space can be left between letters for a given code speed, thus giving the student more time to identify the letter.

There are no degrees of readability in signals. They are either right or wrong, and if they are wrong, it is usually irregular spacing or irregular dash lengths which make them so. If you find that you have a tendency towards irregularity, practice those characters which give you trouble no matter how long you must do so. Until they can be formed perfectly you are not ready for speed.

Be particularly careful of letters like *B*. Many beginners seem to have a tendency to leave a longer space after the dash than that which they place between succeeding dots, thus making it sound like *TS*. Similarly, make sure that you do not leave a longer space after the first dot in the letter *C* than you do between other parts of the same letter; otherwise it will sound like *NN*.

Sending vs. Receiving Once you have memorized the code thoroughly you should concentrate on increasing your receiving speed. True, if you have to practice with another newcomer who is learning the code with you, you will both have to do some sending. But don't attempt to practice *sending* just for the sake of increasing your sending speed.

When transmitting on the code practice set to your partner so that he can get receiving practice, concentrate on the *quality* of your sending, not on your speed.

Because it is comparatively easy to learn to send rapidly, especially when no particular care is given to the quality of sending, many operators who have just received their licenses get on the air and send mediocre or worse code at 20 w.p.m. when they can barely receive good code at 13. Most oldtimers remember their own period of initiation and are only too glad to be patient and considerate if you tell them that you are a newcomer. But the surest way to incur their scorn is to try to impress them with your "lightning speed," and then to request them to send more slowly when they come back at you at the same speed.

Stress your copying ability; never stress your sending ability. It should be obvious that if you try to send faster than you can receive, your ear will not recognize any mistakes which your hand may make.

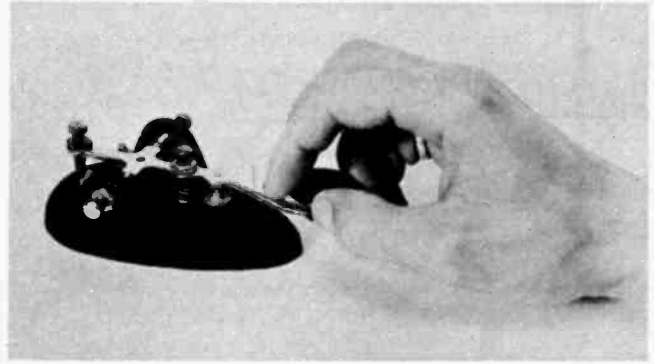

Figure 5.

PROPER POSITION OF THE FINGERS FOR OPERATING A TELEGRAPH KEY.

The fingers hold the knob and act as a cushion. The hand rests lightly on the key. The muscles of the forearm provide the power, the wrist acting as the fulcrum. The power should not come from the wrist, but rather from the forearm muscles.

Using the Key Figure 5 shows the proper position of the fingers and wrist when manipulating a telegraph or radio key. The forearm should rest naturally on the desk. It is preferable that the key be placed far enough back from the edge of the table (about 18 inches) that the elbow can rest on the table. Otherwise, pressure of the table edge on the arm will tend to hinder the circulation of the blood and weaken the ulnar nerve at a point where it is close to the surface, which in turn will tend to increase fatigue considerably.

The knob of the key is grasped lightly with the thumb along the edge; the index and third fingers rest on the top towards the front or far edge. The hand moves with a free up and down motion, the wrist acting as a fulcrum. The power must come entirely from the arm muscles. The third and index fingers will bend slightly during the sending but not because of deliberate effort to manipulate the finger muscles. Keep your finger muscles just tight enough to act as a "cushion" for the arm motion and let the slight movement of the fingers take care of itself. The key's spring is adjusted to the individual wrist and should be neither too stiff nor too loose. Use a moderately stiff tension at first and gradually lighten it as you become more proficient. The separation between the contacts must be the proper amount for the desired speed, being somewhat under 1/16 inch for slow speeds and slightly closer together (about 1/32 inch) for faster speeds. Avoid extremes in either direction.

Do not allow the muscles of arm, wrist, or fingers to become tense. Send with a full, free arm movement. Avoid like the plague any finger motion other than the slight cushioning effect mentioned above.

Remember that you are using different muscles from those which you have used previously. Give them time to become accustomed to the new demands which you put upon them.

Stick to the regular hand key for learning code. No other key is satisfactory for this purpose. Not until you have thoroughly mastered both sending and receiving at the maximum speed in which you are interested should you tackle any form of automatic or semi-automatic key such as the Vibroplex ("bug") or the "sideswiper."

Difficulties Should you experience difficulty in increasing your code speed after you have once memorized the characters, there is no reason to become discouraged. It is more difficult for some people to learn code than for others, but there is no justification for the contention sometimes made

that "some people just can't learn the code." It is not a matter of intelligence; so don't feel ashamed if you seem to experience a little more than the usual difficulty in learning code. Your reaction time may be a little slower or your coordination not so good. If this is the case, remember *you can still learn the code*. You may never learn to send and receive at 40 w.p.m., but you can learn sufficient speed for all non-commercial purposes and even for most commercial purposes if you have patience, and refuse to be discouraged by the fact that others seem to pick it up more rapidly.

Never write down dots and dashes to be translated later. If the alphabet has actually been mastered before hand, there will be no hesitation from failure to recognize most of the characters unless the sending speed is too great.

When the sending operator is sending just a bit too fast for you (the best speed for practice), you will occasionally miss a signal or a small group of them. When you do, leave a blank space; do not spend time futilely trying to recall it; dismiss it, and center attention on the next letter; otherwise you'll miss more. Do not ask the sender any questions until the transmission is finished.

Two or three w.p.m. over your comfortable speed is sufficient; do not let the sender go faster, or you will miss so much as to become discouraged. "Pushing" yourself moderately develops speed just as pushing your muscles develops physical strength.

To prevent guessing and get equal practice on the less common letters, depart occasionally from plain language material and use a jumble of letters in which the usually less commonly used letters predominate.

As mentioned before, many students put a greater space after the dash in the letter *B* than between other parts of the same letter so that it sounds like *TS. C, F, Q, V, X, Y* and *Z* often give similar trouble. Make a list of words or arbitrary combinations in which these letters predominate and practice them, both sending and receiving until they no longer give you trouble. Stop everything else and stick at them. So long as they give you trouble you are not ready for anything else.

Follow the same procedure with letters which you may tend to confuse such as *F* and *L*, which are often confused by beginners. Keep at it until you *always* get them right without having to stop *even an instant* to think about it.

Watch particularly the length of your dashes. They must be equivalent to three dots, neither more nor less. Avoid dragging them out or clipping them off. Non-uniform dashes are a sure sign of a poor operator.

If you do not instantly recognize the sound of any character, you have not learned it; go back and practice your alphabet further. You should never have to omit writing down every signal you hear except when the transmission is too fast for you.

Write down what you hear, not what you think it should be. It is surprising how often the word which you guess will be wrong.

While a slow learner can ultimately get his "13 per" by following the same learning method if he has perseverance, the following system of auxiliary practice oftentimes proves of great aid in increasing one's speed when progress by the usual method seems to have reached a temporary standstill. All that is required is the usual practice outfit plus an extra operator. This last item should be of good quality, guaranteed to pay proper attention to spacing.

Suppose we call the fellow at the key the teacher and the other fellow the student. Assume the usual positions but for the moment lay aside paper and pencil. Instead the student will read from a duplicate newspaper the same text that the operator is sending.

The teacher is to start sending at a rate just slower than the student's top speed judged by his last test. This will allow the student to follow accurately each letter as it is transmitted. After a warming-up period of about one minute the sending speed is to be increased gradually but steadily and continued for a period of five minutes. An equal rest period is beneficial before the second session. Speed for the second period ought to be started at half-way between the original starting speed and the speed used at the end of the first period. Follow the same procedure for the second and third practice periods.

At the start of the third *reading* practice period the student should start copying immediately, using the *same text as before* at a speed just above his previous copying ability. It will be found that one session of the *reading* practice will for the time being increase the student's copying ability from 10 to 20%. The teacher should watch the student and not increase the sending speed too much above his copying ability as this brings about a condition of confusion and is more injurious than beneficial.

Copying Behind All good operators copy several words behind, that is, while one word is being received, they are writing down or typing, say, the fourth or fifth previous word. At first this is very difficult, but after sufficient practice it will be found actually to be *easier* than copying close up. It also results in more accurate copy and enables the receiving operator to capitalize and punctuate copy as he goes along. It is not recommended that the beginner attempt to do this until he can send and receive accurately and with ease at a speed of at least 12 words a minute.

It requires a considerable amount of training to dissociate the action of the subconscious mind from the direction of the conscious mind. It may help some in obtaining this training to write down two columns of short words. Spell the first word in the first column out loud while writing down the first word in the second column. At first this will be a bit awkward, but you will rapidly gain facility with practice. Do the same with all the words, and then reverse columns.

Next try speaking aloud the words in the one column while writing those in the other column; then reverse columns.

After the foregoing can be done easily, try sending with your key the words in one column while spelling those in the other. It won't be easy at first, but it is well worth keeping after if you intend to develop any real code proficiency. Do *not* attempt to catch up. There is a natural tendency to close up the gap, and you must train yourself to overcome this.

Next have your code companion send you a word either from a list or from straight text; do not write it down yet. Now have him send the next word; *after* receiving this second word, write the first word. After receiving the third word, write the second word; and so on. Never mind how slowly you must go, even if it is only two or three words per minute. *Stay behind*.

It will probably take quite a number of practice sessions before you can do this with any facility. After it is relatively easy, then try staying two words behind; keep this up until it is easy. Then try three words, four words, and five words. The more you practice keeping received material in mind, the easier it will be to stay behind. It will be found easier at first to copy material with which one is fairly familiar, then gradually switch to less familiar material.

Automatic Code Machines The two practice sets which are described in this chapter are of most value when you have someone with whom to practice. Automatic code machines are not recommended to anyone who can possibly obtain a companion with whom to practice,

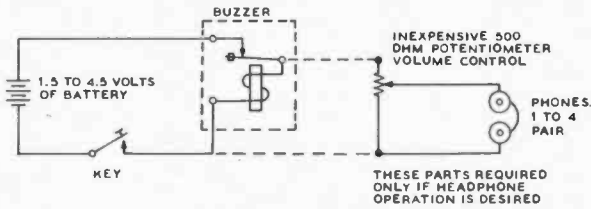

Figure 6.

THE SIMPLEST CODE PRACTICE SET CONSISTS OF A KEY AND A BUZZER.

The buzzer is adjusted to give a steady, high-pitched "whine." If desired, the phones may be omitted, in which case the buzzer should be mounted firmly on a sounding board. Crystal, magnetic, or dynamic earphones may be used. Additional sets of phones should be connected in parallel, not in series.

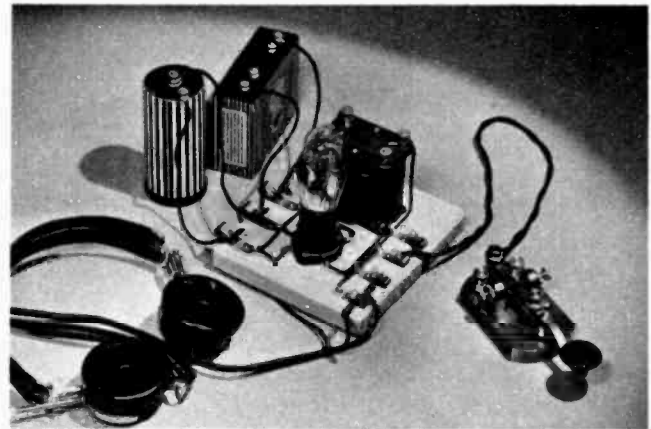

Figure 8.

THE CIRCUIT OF FIGURE 8 IS USED IN THIS BATTERY-OPERATED CODE PRACTICE OSCILLATOR.

A tube and audio transformer essentially comprise the oscillator. Fahnstock clips screwed to the base-board are used to make connection to the batteries, key, and phones.

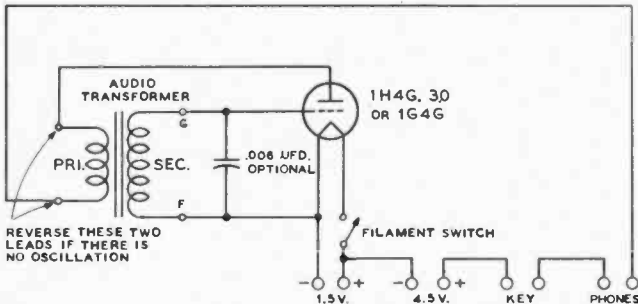

Figure 7.

SIMPLEST TYPE VACUUM-TUBE CODE PRACTICE OSCILLATOR.

Power is furnished by a dry cell and a 4 1/2-volt "C" battery. If the 0.006-ufd. capacitor is omitted, a higher pitched note will result. The note may have too low a pitch even without the capacitor unless the smallest, least expensive audio transformer available is used. The earphones must be of the magnetic or dynamic type since the plate current of the oscillator must flow through the phones.

someone who is also interested in learning the code. If you are unable to enlist a code partner and have to practice by yourself, the best way to get receiving practice is by the use of a tape machine (automatic code sending machine) with several practice tapes. Or you can use a set of phonograph code practice records. The records are of use only if you have a phonograph whose turntable speed is readily adjustable. The tape machine can be rented by the month for a reasonable fee.

Once you can copy about 10 w.p.m. you can also get receiving practice by listening to slow sending stations on your receiver. Many amateur stations send slowly particularly when working far distant stations. When receiving conditions are particularly poor many commercial stations also send slowly, sometimes repeating every word. Until you can copy around 10 w.p.m. your receiver isn't of much use, and either another operator or a machine or records is necessary for getting receiving practice after you have once memorized the code.

Code Practice Sets If you don't feel too foolish doing it, you can secure a measure of code practice with the help of a partner by sending "dit-dah" messages to each other while riding to work, eating lunch, etc. It is better, however, to use a buzzer or code practice oscillator in conjunction with a regular telegraph key.

As a good key may be considered an investment, it is wise to make a well-made key your first purchase. Regardless of what type code practice set you use, you will need a key, and later on you will need one to key your transmitter. If you get a good key to begin with, you won't have to buy another one later.

The key should be rugged and have fairly heavy contacts. Not only will the key stand up better, but such a key will

contribute to the "heavy" type of sending so desirable for radio work. Morse (telegraph) operators use a "light" style of sending and can send somewhat faster when using this light touch. But, in radio work static and interference are often present, and a slightly heavier dot is desirable. If you use a husky key, you will find yourself automatically sending in this manner.

To generate a tone simulating a code signal as heard on a receiver, either a mechanical buzzer or an audio oscillator may be used. Figure 6 shows a simple code-practice set using a buzzer which may be used directly simply by mounting the buzzer on a sounding board, or the buzzer may be used to feed from one to four pairs of conventional high-impedance phones.

An example of the audio-oscillator type of code-practice set is illustrated in Figures 7 and 8. Any type of battery-filament tube may be used in this circuit to make up a satisfactory "howler" for code-practice work. The circuit is described in Figure 7.

THE AMATEUR BANDS

3.500-	4.000—A1	("80-meter band")
3.850-	4.000—A3, Class A only	("75-meter phone")
7.000-	7.300—A1	("40-meter band")
14.000-	14.400—A1	("20-meter band")
14.200-	14.300—A3, Class A only	("20-meter phone")
27.160-	27.430—A0, A1, A2, A3, A4, FM	("11-meter band")
28.000-	29.700—A1	("10-meter band")
28.500-	29.700—A3	("10-meter phone")
29.000-	29.700—FM	("10-meter FM")
50.000-	54.000—A1, A2, A3, A4	("6-meter band")
52.500-	54.000—FM	("6-meter FM")
144.000-	148.000—A0, A1, A2, A3, A4, FM (except see below) ("2 meters")	
144.000-	146.500—Within 50 ml. of Honolulu, Seattle, and Wash. D.C.	
235.000-	240.000—A0, A1, A2, A3, A4, FM ("1 1/4 meters")	
420.000-	450.000—A0, A1, A2, A3, A4, A5, FM (Peak ant. pwr. 50 watts)	
1,215.000-	1,295.000	A0, A1, A2, A3, A4, A5, FM, Pulse
2,300.000-	2,450.000	
3,300.000-	3,500.000	
5,650.000-	5,850.000	
10,000.000-	10,500.000	
21,000.000-	21,500.000	
All above	30,000.000	

All frequencies are in megacycles. A0 means unmodulated carrier, A1 means c-w telegraphy, A2 is modulated c.w., A3 is radiotelephony with amplitude modulation, A4 is facsimile, A5 is television, FM is frequency modulation either for telegraphy or telephony.

Fundamentals of Electricity and Radio

ALL matter is made up of approximately 94 fundamental constituents commonly called *elements*. These elements can exist either in the free state such as iron, oxygen, carbon, copper, tungsten, and aluminum, or in chemical unions commonly called *compounds*. The smallest unit which still retains all the original characteristics of an element is the *atom*.

Combinations of atoms, or subdivisions of compounds, result in another fundamental unit, the *molecule*. The molecule is the smallest unit of any compound. All reactive elements when in the gaseous state also exist in the molecular form, made up of two or more atoms. The nonreactive or noble gaseous elements helium, neon, argon, krypton, xenon, and radon are the only gaseous elements that ever exist in a stable atomic state at ordinary temperatures.

The Atom An atom is an extremely small unit of matter—there are literally billions of them making up so small a piece of material as a speck of dust. But to understand the basic theory of electricity and hence of radio, we must go further and divide the atom into its main components, a positively charged nucleus and a cloud of negatively charged particles that surround the nucleus. These particles, swirling around the nucleus in elliptical orbits at an incredible rate of speed, are called orbital electrons.

It is upon the behavior of these electrons that depends the study of electricity and radio, as well as allied sciences. Actually it is possible to subdivide the nucleus of the atom into other particles: the proton, nuclear electron, negatron, positron, and neutron; but this further subdivision can be left to quantum mechanics and atomic physics. As far as radio theory is concerned it is only necessary for the reader to think of the normal atom as being composed of a nucleus having a net positive charge that is exactly neutralized by the one or more orbital electrons surrounding it.

The atoms of different elements differ in respect to the charge on the positive nucleus and in the number of electrons revolving around this charge. They range all the way from

hydrogen, having a net charge of one on the nucleus and one orbital electron, to plutonium (of atom bomb usage) with a net charge of 94, and 94 orbital electrons. The number of orbital electrons is called the *atomic number* of the element.

From the above it must not be thought that the electrons revolve in a haphazard manner around the nucleus. Rather, the electrons in an element having a large atomic number are grouped into "shells" having a definite number of electrons. The only atoms in which these shells are completely filled are those of the inert or noble gases mentioned before; all other elements have one or more uncompleted shells of electrons. If the uncompleted shell is nearly empty, the element is *metallic* in character, being most metallic when there is only one electron in the outer shell. If the incomplete shell lacks only one or two electrons, the element is usually *non-metallic*. Elements with a shell about half completed will exhibit both non-metallic and metallic character; carbon, silicon, and arsenic are examples of this type of element.

In metallic elements these outer-shell electrons are rather loosely held. Consequently, there is a continuous helter-skelter movement of these electrons and a continual shifting from one atom to another. The electrons which move about in a substance are called *free electrons*, and it is the ability of these electrons to drift from atom to atom which makes possible the *electric current*.

If the free electrons are numerous and loosely held, the element is a good conductor. On the other hand, if there are few free electrons, as is the case when the electrons in an outer shell are tightly held, the element is a poor conductor. If there are virtually no free electrons, as a result of the outer shell electrons being tightly held, the element is a good insulator.

2-1 Fundamental Electrical Units and Relationships

Electromotive Force: The free electrons in a conductor move constantly about and change their position in a haphazard manner. To produce a drift of electrons or *electric current* along a wire it is

necessary that there be a difference in pressure or *potential* between the two ends of the wire. This *potential difference* can be produced by connecting a battery to the ends of the wire.

As will be explained later, there is an excess of electrons at the negative terminal of a battery and a deficiency of electrons at the positive terminal, due to chemical action. When the battery is connected to the wire, the deficient atoms at the positive terminal attract free electrons from the wire in order to become neutral. The attracting of electrons continues through the wire, and finally the excess electrons at the negative terminal of the battery are attracted by the positively charged atoms at the end of the wire. The same result would be obtained if the wire were connected between the terminals of a generator.

Thus it is seen that a potential difference is the result of a difference in the number of electrons between the two (or more) points in question. The force or pressure due to a potential difference is termed the *electromotive force*, usually abbreviated *e.m.f.* or *E.M.F.* It is expressed in units called *volts*.

It should be noted that for there to be a potential difference between two bodies or points it is not necessary that one have a positive charge and the other a negative charge. If two bodies each have a negative charge, but one more negative than the other, the one with the lesser negative charge will act as though it were positively charged *with respect to the other body*. It is the *algebraic* potential difference that determines the force with which electrons are attracted or repulsed, the potential of the earth being taken as the zero reference point.

The Electric Current The flow of electrons along a conductor due to the application of an electromotive force constitutes an electric current. This drift is in addition to the irregular movement of the electrons. However, it must not be thought that each free electron travels from one end of the circuit to the other. On the contrary, each free electron travels only a short distance before colliding with an atom; this collision generally knocking off one or more electrons from the atom, which in turn move a short distance and collide with other atoms, knocking off other electrons. Thus, in the general drift of electrons along a wire carrying an electric current, each electron travels only a short distance and the excess of electrons at one end and the deficiency at the other are balanced by the source of the *e.m.f.* When this source is removed the state of normalcy returns; there is still the rapid interchange of free electrons between atoms, but there is no general trend or "net movement" in either one direction or the other.

Ampere and Coulomb There are two units of measurement associated with current, and they are often confused. The *rate of flow* of electricity is stated in *amperes*.

The unit of *quantity* is the *coulomb*. A coulomb is equal to 6.28×10^{18} electrons, and when this quantity of electrons flows by a given point in every second, a current of one ampere is said to be flowing. An ampere is equal to one coulomb per second; a coulomb is, conversely, equal to one ampere-second. Thus we see that *coulomb* indicates *amount*, and *ampere* indicates *rate of flow*.

Many textbooks speak of current flow as being from the positive terminal of the *e.m.f.* source through the conductor to the negative terminal. Nevertheless, it has long been an established fact that the current flow in a metallic conductor is the *electronic* flow from the negative terminal of the source of voltage through the conductor to the positive terminal. This is easily seen from a study of the foregoing explanation of the subject. The only exceptions to the electronic direction of flow occur in gaseous and electrolytic conductors where the

flow of positive ions toward the cathode or negative electrode constitutes a positive flow in the opposite direction to the electronic flow. (An ion is an atom, molecule, or particle which either lacks one or more electrons, or else has an excess of one or more electrons.)

In radio work the terms "electron flow" and "current" are becoming accepted as being synonymous, but the older terminology is still accepted in the electrical (industrial) field. Because of the confusion this sometimes causes, it is often safer to refer to the direction of electron flow rather than to the direction of the "current." Since electron flow consists actually of a passage of *negative* charges, current flow and *algebraic* electron flow do pass in the same direction.

Resistance The flow of current in a material depends upon the ease with which electrons can be detached from the atoms of the material and upon its molecular structure. In other words, the easier it is to detach electrons from the atoms the more free electrons there will be to contribute to the flow of current, and the fewer collisions that occur between free electrons and atoms the greater will be the total electron flow.

The opposition to a steady electron flow is called the *resistance* of a material, and is one of its physical properties. The resistance of a uniform length of a given substance is directly proportional to its length and specific resistance, and inversely proportional to its cross-sectional area. A wire with a certain resistance for a given length will have twice as much resistance if the length of the wire is doubled. For a given length, doubling the cross-sectional area of the wire will *halve* the resistance.

The resistance also depends upon temperature, increasing with increases in temperature for most substances (including most metals), due to increased electron acceleration and hence a greater number of impacts between electrons and atoms. However, in the case of some substances such as carbon and glass the temperature coefficient is negative, which means that the resistance decreases as the temperature increases. This is also true of electrolytes. The temperature may be raised by the external application of heat, or by the flow of the current itself. In the latter case, this is due to the fact that heat is generated when the electrons and atoms collide. (See *Heating Effect*.)

The unit of resistance is the *ohm*. Every substance has a *specific resistance*, usually expressed as *ohms per mil-foot*, which is determined by the material's molecular structure and temperature. A mil-foot is a piece of material one circular mil in area and one foot long. Another measure of resistivity frequently used is expressed in the units *microhms per centimeter cube*.

Conductors and Insulators In the molecular structure of many materials such as glass, porcelain, and mica all electrons are tightly held within their orbits

TABLE OF RESISTIVITY

Material	Resistivity in Microhms/Cm cube	Temp. Coeff. of resistance per °C at 20° C.
Aluminum	2.83	0.0049
Brass	7.5	0.003 to 0.007
Cadmium	7.6	0.0038
Chromium	2.7	0.00
Copper	1.73	0.0039
Iron	9.8	0.006
Silver	1.63	0.004
Zinc	5.9	0.0035
Nichrome	108.0	0.0002
Constantan	49.0	0.00001
Manganin	48.0	0.00001
Monel	43.0	0.0019

and there are comparatively few free electrons. This type of substance will conduct an electric current only with great difficulty and is known as an *insulator*. An insulator is said to have a high electrical *resistance*.

On the other hand, materials that have a large number of free electrons are known as *conductors*. Most metals, those elements which have only one or two electrons in their outer shell, are good conductors. Silver, copper, and aluminum, in that order, are the best of the common metals used as conductors and are said to have the greatest *conductivity*, or lowest resistance to the flow of an electric current.

Fundamental Electrical Units These units are the *volt*, the *ampere*, and the *ohm*. They were mentioned in the preceding paragraphs, but were not completely defined in terms of fixed, known quantities.

The fundamental unit of *current*, or *rate of flow* of electricity is the *ampere*. A current of one ampere will deposit silver from a specified solution of silver nitrate at a rate of 1.118 milligrams per second.

The international standard for the ohm is the resistance offered by a column of mercury at 0° C., 14.4521 grams in mass, of constant cross-sectional area and 106.300 centimeters in length. The expression *megohm* (1,000,000 ohms) is also sometimes used when speaking of very large values of resistance.

A volt is the e.m.f. that will produce a current of one ampere through a resistance of one ohm. The standard of electromotive force is the Weston cell which at 20° C. has a potential of 1.0183 volts across its terminals. This cell is used only for reference purposes in a bridge circuit, since only an infinitesimal amount of current may be drawn from it without disturbing its characteristics.

Ohm's Law The relationship between the electromotive force (voltage), the flow of current (amperes), and the resistance which impedes the flow of current (ohms), is very clearly expressed in a simple but highly valuable law known as *Ohm's law*. This law states that *the current in amperes is equal to the voltage in volts divided by the resistance in ohms*. Expressed as an equation:

$$I = \frac{E}{R}$$

If the voltage (E) and resistance (R) are known, the current (I) can be readily found. If the voltage and current are known, and the resistance is unknown, the resistance (R) is

equal to $\frac{E}{I}$. When the voltage is the unknown quantity, it

can be found by multiplying $I \times R$. These three equations are all secured from the original by simple transposition. The expressions are here repeated for quick reference:



Figure 1.

SIMPLE SERIES CIRCUITS.

At (A) the battery is in series with a single resistor. At (B) the battery is in series with two resistors, the resistors themselves being in series. The arrows indicate the direction of electron flow.

Figure 2.
SIMPLE PARALLEL CIRCUIT.

The two resistors R_1 and R_2 are said to be in parallel since the current divides between them. An electron leaving point A goes through either R_1 or R_2 , but not through both, to get to the positive terminal of the battery.

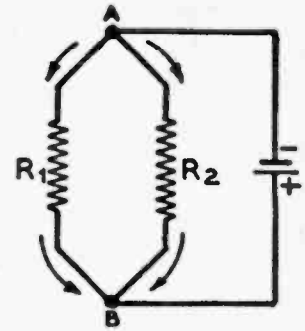

$$I = \frac{E}{R} \qquad R = \frac{E}{I} \qquad E = IR$$

where I is the current in amperes,
 R is the resistance in ohms,
 E is the electromotive force in volts.

Applications of Ohm's Law All electrical circuits fall into one of three classes: series circuits, parallel circuits, and series-parallel circuits. A series circuit is one

in which the current flows in a single continuous path and is of the same value at every point in the circuit. In a parallel circuit there are two or more current paths between two points in the circuit, as shown in Figure 2. Here the current divides at A, part going through R_1 and part through R_2 , and combines at B to return to the battery. Figure 4 shows a series-parallel circuit. There are two paths between points A and B as in the parallel circuit, and in addition there are two resistances in series in each branch of the parallel combination. Two other examples of series-parallel arrangements appear in Figure 5. The way in which the current splits to flow through the parallel branches is shown by the arrows.

In every circuit, each of the parts has some resistance: the batteries or generator, the connecting conductors, and the apparatus itself. Thus, if each part has some resistance, no matter how little, and a current is flowing through it, there will be a voltage drop across it. In other words, there will be a potential difference between the two ends of the circuit element in question. This drop in voltage is equal to the product of the current and the resistance, hence it is called the *IR drop*.

The source of voltage has an *internal* resistance, and when connected into a circuit so that current flows, there will be an IR drop in the source just as in every other part of the circuit. Thus, if the terminal voltage of the source could be measured in a way that would cause no current to flow, it would be found to be more than the voltage measured when a current flows by the amount of the IR drop in the source. The voltage measured with no current flowing is termed the *no load* voltage; that measured with current flowing is the *load* voltage. It is apparent that a voltage source having a low internal resistance is most desirable, in order that the internal IR drop will be as small as possible, thereby making the load voltage more nearly equal to the no load voltage.

Resistances in Series The current flowing in a series circuit is equal to the voltage impressed divided by the *total* resistance across which the voltage is impressed. Since the same current flows through every part of the circuit, it is merely necessary to add all the individual resistances to obtain the total resistance. Expressed as a formula:

$$R_{total} = R_1 + R_2 + R_3 + \dots + R_N$$

Of course, if the resistances happened to be all of the same

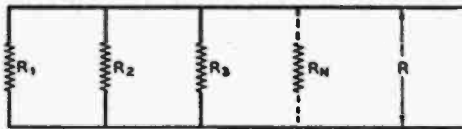

Figure 3.
SEVERAL RESISTORS IN PARALLEL.

value, the total resistance would be the resistance of one multiplied by the number in the circuit.

Resistances in Parallel Consider two resistors, one of 100 ohms and one of 10 ohms, connected in parallel as in Figure 2, with a voltage of 10 volts applied across the combination. The same voltage is across each resistor, so the current through each can be easily calculated.

$$I = \frac{E}{R}$$

$$E = 10 \text{ volts}$$

$$R = 100 \text{ ohms}$$

$$I = \frac{10}{100} = 0.1 \text{ ampere}$$

$$E = 10 \text{ volts}$$

$$R = 10 \text{ ohms}$$

$$I = \frac{10}{10} = 1.0 \text{ ampere}$$

Until it divides at A, the entire current of 1.1 amperes is flowing through the conductor from the battery, and again from B through the conductor to the battery. Since this is more current than flows through the smaller resistor it is evident that the resistance of the parallel combination must be less than 10 ohms, the resistance of the smaller resistor. We can find this value by applying Ohm's law.

$$R = \frac{E}{I}$$

$$E = 10 \text{ volts}$$

$$I = 1.1 \text{ amperes}$$

$$R = \frac{10}{1.1} = 9.09 \text{ ohms}$$

The resistance of the parallel combination is 9.09 ohms. Mathematically, we can derive a simple formula for finding the effective resistance of two resistors connected in parallel. This formula is:

$$R = \frac{R_1 \times R_2}{R_1 + R_2}$$

where *R* is the unknown resistance,
*R*₁ is the resistance of the first resistor,
*R*₂ is the resistance of the second resistor.

If the effective value required is known, and it is desired to connect one unknown resistor in parallel with one of known value, to obtain this unknown value the following transposition of the above formula will simplify the problem:

$$R_2 = \frac{R_1 \times R}{R_1 - R}$$

where *R* is the effective value required,
*R*₁ is the known resistor,
*R*₂ is the value of the unknown resistance necessary to give *R* when in parallel with *R*₁.

The resultant value of placing a number of unlike resistors

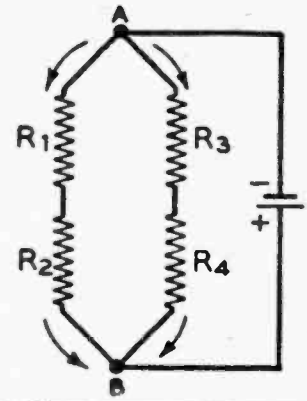

Figure 4.
SERIES-PARALLEL CIRCUIT.
In this type of circuit the resistors are arranged in series groups and in parallel groups.

in parallel is equal to the reciprocal of the sum of the reciprocals of the various resistors. This can be expressed as:

$$R = \frac{1}{\frac{1}{R_1} + \frac{1}{R_2} + \frac{1}{R_3} + \dots + \frac{1}{R_n}}$$

The effective value of placing any number of unlike resistors in parallel can be determined from the above formula. However, it is commonly used only when there are three or more resistors under consideration, since the simplified formula given before is more convenient when only two resistors are being used.

When two or more resistors of the same value are placed in parallel, the effective resistance of the paralleled resistors is equal to the value of one of the resistors divided by the number of resistors in parallel.

The effective value of resistance of two or more resistors connected in parallel is *always* less than the value of the lowest resistance in the combination. It is well to bear this simple rule in mind, as it will assist greatly in approximating the value of paralleled resistors.

Shunts When a voltage is applied to a circuit consisting of two or more resistors in parallel the resulting current divides itself among the paths in inverse proportion to the resistance of each path. With respect to one of the elements those connected in parallel with it are said to *shunt* it.

An example of a shunt which is of particular interest is the use of a resistor to shunt an ammeter or milliammeter (a device for measuring current) so that part of the current in the circuit will be bypassed around the meter. By this means the range of a meter may be greatly extended. Multiplying the range by powers of 10 makes it possible to use the original calibration scale without having to perform calculations in taking readings.

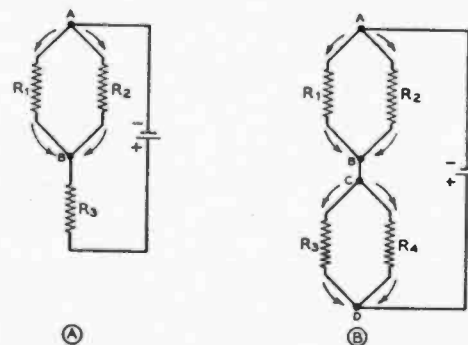

Figure 5.
OTHER COMMON SERIES-PARALLEL CIRCUITS.

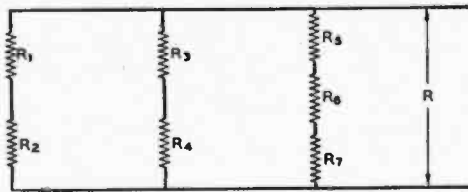

Figure 6.
ANOTHER METHOD OF INDICATING A SERIES-PARALLEL CIRCUIT.

To calculate the amount of resistance required in a given case, the basic form of Ohm's law may be used. However, the following formula (derived from Ohm's law) simplifies the calculations:

$$R = \frac{R_m \times I_m}{I - I_m}$$

where R = resistance of shunt in ohms,
 R_m = resistance of meter in ohms,
 I_m = full scale current for meter,
 I = full scale current for new calibration.

Resistors in Series-Parallel To find the total resistance of several resistors connected in series-parallel, it is usually easiest to apply either the formula for series resistors or the parallel resistor formula first, in order to reduce the original arrangement to a simpler one. For instance, in Figure 4 the series resistors should be added in each branch, then there will be but two resistors in parallel to be calculated. Similarly in Figure 6, although here there will be three parallel resistors after adding the series resistors in each branch. In Figure 5 the paralleled resistors should be reduced to the equivalent series value, and then the series resistance values can be added.

Resistances in series-parallel can be solved by combining the series and parallel formulas into one similar to the following (refer to Figure 6):

$$R = \frac{1}{\frac{1}{R_1 + R_2} + \frac{1}{R_3 + R_4} + \frac{1}{R_5 + R_6 + R_7}}$$

Voltage Dividers A voltage divider is exactly what its name implies: a resistor or a series of resistors connected across a source of voltage from which various lesser values of voltage may be obtained by connection to various points along the resistor.

A voltage divider serves a most useful purpose in a radio receiver, transmitter or amplifier, because it offers a simple means of obtaining plate, screen, and bias voltages of different values from a common power supply source. It may also be used to obtain very low voltages of the order of .01 to .001 volt with a high degree of accuracy, even though a means of measuring such voltages is lacking. The procedure for making these measurements can best be given in the following example.

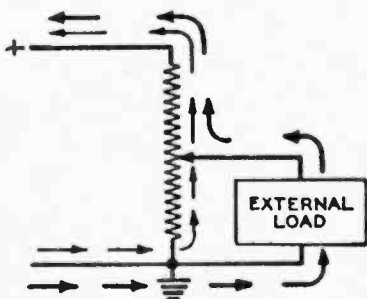

Figure 7.
TAPPED VOLTAGE DIVIDER.
The arrows indicate the manner in which the electrons divide between the voltage divider itself and the external load circuit.

Assume that an accurately calibrated voltmeter reading from 0 to 150 volts is available, and that the source of voltage is exactly 100 volts. This 100 volts is then impressed through a resistance of exactly 1,000 ohms. It will, then, be found that the voltage along various points on the resistor, with respect to the grounded end, is exactly proportional to the resistance at that point. From Ohm's law, the current would be 0.1 ampere; this current remains unchanged since the original value of resistance (1,000 ohms) and the voltage source (100 volts) are unchanged. Thus, at a 500-ohm point on the resistor (half its entire resistance), the voltage will likewise be halved or reduced to 50 volts.

The equation (E = I × R) gives the proof: E = 500 × 0.1 = 50. At the point of 250 ohms on the resistor, the voltage will be one-fourth the total value, or 25 volts (E = 250 × 0.1 = 25). Continuing with this process, a point can be found where the resistance measures exactly 1 ohm and where the voltage equals 0.1 volt. It is, therefore, obvious that if the original source of voltage and the resistance can be measured, it is a simple matter to predetermine the voltage at any point along the resistor, provided that the current remains constant, and provided that no current is taken from the tap-on point unless this current is taken into consideration.

Figuring Voltage Dividers Proper design of a voltage divider for any type of radio equipment is a relatively simple matter. The first consideration is the amount of "bleeder current" to be drawn. In addition, it is also necessary that the desired voltage and the exact current at each tap on the voltage divider be known.

Figure 7 illustrates the flow of current in a simple voltage divider and load circuit. The light arrows indicate the flow of bleeder current, while the heavy arrows indicate the flow of the load current. The design of a combined bleeder resistor and voltage divider, such as is commonly used in radio equipment, is illustrated in the following example.

A power supply delivers 300 volts and is conservatively rated to supply all needed current for the receiver and still allow a bleeder current of 10 milliamperes. The following voltages are wanted: 75 volts at 2 milliamperes for the detector tube, 100 volts at 5 milliamperes for the screens of the tubes, and 250 volts at 20 milliamperes for the plates of the tubes. The required voltage drop across R₁ is 75 volts, across R₂ 25 volts, across R₃ 150 volts, and across R₄ it is 50 volts. These values are shown in the diagram of Figure 8. The

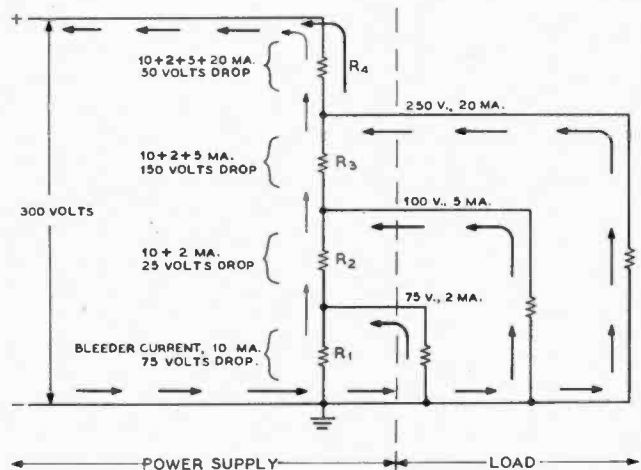

Figure 8.
MORE COMPLEX VOLTAGE DIVIDER.
The method of calculating the values of the resistors (or the values of resistance between taps) is covered in the text.

respective current values are also indicated. Apply Ohm's law:

$$R_1 = \frac{E}{I} = \frac{75}{.01} = 7,500 \text{ ohms.}$$

$$R_2 = \frac{E}{I} = \frac{25}{.012} = 2,083 \text{ ohms.}$$

$$R_3 = \frac{E}{I} = \frac{150}{.017} = 8,823 \text{ ohms.}$$

$$R_4 = \frac{E}{I} = \frac{50}{.037} = 1,351 \text{ ohms.}$$

$$R_{\text{Total}} = 7,500 + 2,083 + 8,823 + 1,351 = 19,757 \text{ ohms.}$$

A 20,000-ohm resistor with three sliding taps will be of the approximately correct size, and would ordinarily be used because of the difficulty in securing four separate resistors of the exact odd values indicated, and because no adjustment would be possible to compensate for any slight error in estimating the probable currents through the various taps.

When the sliders on the resistor once are set to the proper point, as in the above example, the voltages will remain constant at the values shown as long as the current remains a constant value.

Disadvantages of Voltage Dividers One of the serious disadvantages of the voltage divider becomes evident when the current drawn from one of the taps changes. It is obvious that the voltage drops are interdependent and, in turn, the individual drops are in proportion to the current which flows through the respective sections of the divider resistor. The only remedy lies in providing a heavy steady bleeder current in order to make the individual currents so small a part of the total current that any change in current will result in only a slight change in voltage. This can seldom be realized in practice because of the excessive values of bleeder current which would be required.

Kirchhoff's Laws Ohm's law is all that is necessary to calculate the values in simple circuits, such as the preceding examples; but in more complex problems, involving more than one voltage in the same closed circuit, the use of *Kirchhoff's laws* will greatly simplify the calculations. These laws are merely rules for applying Ohm's law.

The first law states that at any point in a circuit the current flowing toward the point is equal to the current flowing from it. In other words, if currents flowing to the point are considered positive, and those flowing from the point are considered negative, their sum—taking signs into account—is zero. Such a sum is known as an *algebraic sum*.

Figure 9 illustrates this first law. It is readily seen that 4 amperes flow toward point A, and 2 amperes flow away through the two 5-ohm resistors in series, while the remaining 2 amperes flow away through the 10-ohm resistor. Thus, there are 4 amperes flowing to point A and 4 amperes flowing away from the point. If R is the effective resistance of the network, $R_1 = 10$ ohms, $R_2 = 5$ ohms, $R_3 = 5$ ohms, and $E = 20$ volts, we can set up the following equation:

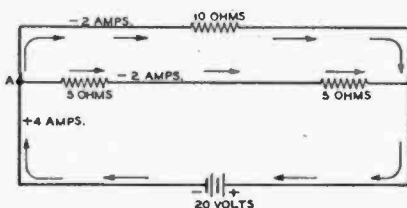
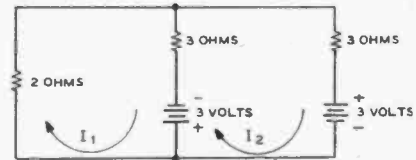

Figure 9. ILLUSTRATING KIRCHHOFF'S FIRST LAW
The current flowing toward point "A" is equal to the current flowing away from point "A".



1. SET VOLTAGE DROPS AROUND EACH LOOP EQUAL TO ZERO
 $I_1 2(\text{OHMS}) + 2(I_1 - I_2) + 3 = 0$ (FIRST LOOP)
 $-6 + 2(I_2 - I_1) + 3 I_2 = 0$ (SECOND LOOP)
2. SIMPLIFY
 $2 I_1 + 2 I_1 - 2 I_2 + 3 = 0$ $2 I_2 - 2 I_1 + 3 I_2 - 6 = 0$
 $\frac{4 I_1 + 3}{2} = I_2$ $S I_2 - 2 I_1 - 6 = 0$
 $\frac{2 I_1 + 6}{5} = I_2$
3. EQUATE
 $\frac{4 I_1 + 3}{2} = \frac{2 I_1 + 6}{5}$
4. SIMPLIFY
 $20 I_1 + 15 = 4 I_1 + 12$
 $I_1 = -\frac{3}{16}$ AMPERE
5. RE-SUBSTITUTE
 $I_2 = \frac{-\frac{18}{8} + 3}{2} = \frac{2\frac{1}{2}}{2} = 1\frac{1}{8}$ AMPERE

Figure 10. ILLUSTRATING KIRCHHOFF'S SECOND LAW
The voltage drop around any closed loop in a network is equal to zero.

$$\frac{E}{R} - \frac{E}{R_1} - \frac{E}{R_2 + R_3} = 0$$

$$\frac{20}{5} - \frac{20}{10} - \frac{20}{5 + 5} = 0$$

$$4 - 2 - 2 = 0$$

Kirchhoff's second law states that in any closed path in a network the sum of the IR drops must equal the sum of the applied e.m.f.s, or, the algebraic sum of the IR drops and the applied e.m.f.s in any closed path in a network is zero. The applied e.m.f.s are considered positive, while IR drops taken in the direction of current flow (including the internal drop of the source) are considered negative.

Figure 10 shows an example of the application of Kirchhoff's laws to a comparatively simple circuit consisting of three resistors and two batteries. First assume an arbitrary direction of current flow in each closed loop of the circuit. Next draw an arrow to indicate the direction of current flow assumed so that you will not forget. Then equate the sum of all IR drops plus battery drops around each loop to zero. You will need one equation for each unknown to be determined. Then solve the equations for the unknown currents in the general manner indicated in Figure 10. If the answer comes out positive the direction of current flow you originally assumed was correct. If the answer comes out negative, the current flow is in the opposite direction to the arrow which was drawn originally. This is illustrated in the example of Figure 10 where the direction of flow of I_1 is opposite to the direction assumed in the sketch.

Power in Resistive Circuits In order to cause electrons to flow through a conductor, constituting a current flow, it is necessary to apply an electromotive force (voltage) across the circuit. Less power is expended in creating a small current flow through a given resistance than in creating a large one; so it is necessary to have a unit of power as a reference.

The unit of electrical power is the *watt*, which is the amount of power used when an e.m.f. of 1 volt forces a current of 1 ampere through a circuit. The power in a resistive circuit is equal to the product of the voltage applied across, and the current flowing in, a given circuit. Hence: P (watts) = E (volts) \times I (amperes).

Since it is often convenient to express power in terms of the resistance of the circuit and the current flowing through it, a substitution of IR for E ($E = IR$) in the above formula gives: $P = IR \times I$ or $P = I^2R$. In terms of voltage and resistance, $P = E^2/R$. Here, $I = E/R$ and when this is substituted for I the original formula becomes $P = E \times E/R$, or $P = E^2/R$. To repeat these three expressions:

$$P = EI, P = I^2R, \text{ and } P = E^2/R,$$

where P is the power in watts,

E is the electromotive force in volts,

and

I is the current in amperes.

To apply the above equations to a typical problem: The voltage drop across a cathode resistor in a power amplifier stage is 50 volts; the plate current flowing through the resistor is 150 milliamperes. The number of watts the resistor will be required to dissipate is found from the formula: $P = EI$, or $50 \times .150 = 7.5$ watts (.150 amperes is equal to 150 milliamperes). From the foregoing it is seen that a 7.5-watt resistor will safely carry the required current, yet a 10- or 20-watt resistor would ordinarily be used to provide a safety factor.

In another problem, the conditions being similar to those above, but with the resistance and current being the *known* factors, the solution is obtained as follows: $P = I^2R = .0225 \times 333.33 = 7.5$. If only the voltage and resistance are known, $P = E^2/R = 2500/333.33 = 7.5$ watts. It is seen that all three equations give the same result; the selection of the particular equation depends only upon the known factors.

Heating Effect Heat is generated when a source of voltage causes a current to flow through a resistor (or, for that matter, through any conductor). As explained earlier, this is due to the fact that heat is given off when free electrons collide with the atoms of the material. More heat is generated in high resistance materials than in those of low resistance, since the free electrons must strike the atoms harder to knock off other electrons. As the heating effect is a function of the current flowing and the resistance of the circuit, the power expended in heat is given by the second formula: $P = I^2R$.

Load Matching To develop the maximum power in the load upon a source of e.m.f., it is necessary to make the resistance (or impedance) of the load equal to the internal resistance (or impedance) of the source. This can best be illustrated by Figure 11. Assume R_i is the internal resistance of the source and has a value of 1 ohm, while the source E has a no-load voltage of 2 volts. If the load resistance R_L is also 1 ohm, the current is:

$$I = \frac{E}{R_i + R_L} = \frac{2}{1 + 1} = 1 \text{ ampere.}$$

The total power dissipated is:

$$P = EI = 2 \times 1 = 2 \text{ watts,}$$

which is divided equally between the source and the load.

If R_L is 2 ohms the current is:

$$I = \frac{2}{1 + 2} = 0.67 \text{ ampere,}$$

and the total power dissipated is:

$$P = 2 \times 0.67 = 1.34 \text{ watts.}$$

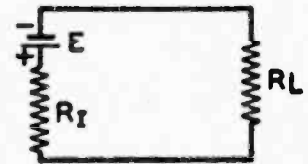

Figure 11.

To dissipate the greatest amount of power in the load, the load resistance R_L should be equal to the internal resistance of the battery R_i .

The portion dissipated in the load is:

$$P = 0.67^2 \times 2 = 0.9 \text{ watt,}$$

and the remainder, 0.44 watt, is dissipated in the source. If R_L is 0.5 ohms, the current in the circuit is:

$$I = \frac{2}{1 + 0.5} = 1.33 \text{ amperes.}$$

The total power is:

$$P = 2 \times 1.33 = 2.66 \text{ watts.}$$

The load dissipation is:

$$P = 1.33^2 \times 0.5 = 0.88 \text{ watt,}$$

while 1.78 watts are dissipated in the source. Thus, it is seen that, while the total dissipated power may be greater under other conditions, the dissipation in the load is greatest when its resistance equals that of the source.

2-2 Electromagnetism

The common bar or horseshoe magnet is familiar to most people. The magnetic field which surrounds it causes the magnet to attract other magnetic materials, such as iron nails or tacks. Exactly the same kind of magnetic field is set up around any conductor carrying a current, but the field exists only while the current is flowing.

Magnetic Fields Before a potential, or voltage, is applied to a conductor, there is no external field, because there is no general movement of the electrons in one direction. However, the electrons do progressively move along the conductor when an e.m.f. is applied, the direction of motion depending upon the polarity of the e.m.f. Since each electron has an electric field about it, the flow of electrons causes these fields to build up into a resultant external field which acts in a plane at right angles to the direction in which the current is flowing. This field is known as the *magnetic field*.

The magnetic field around a current-carrying conductor is illustrated in Figure 12. The direction of this magnetic field depends entirely upon the direction of electron drift or current flow in the conductor. When the flow is toward the observer, the field about the conductor is clockwise; when the flow is away from the observer, the field is counter-clockwise. This is easily remembered if the left hand is clenched, with the thumb outstretched and pointing in the direction of electron flow. The fingers then indicate the direction of the magnetic field around the conductor.

Each electron adds its field to the total external magnetic field, so that the greater the number of electrons moving along the conductor, the stronger will be the resulting field.

One of the fundamental laws of magnetism is that *like poles repel one another and unlike poles attract one another*. This is true of current-carrying conductors as well as of permanent magnets. Thus, if two conductors are placed side by side and the current in each is flowing in the same direction, the magnetic fields will also be in the same direction and will combine to form a larger and stronger field. If the current flow in adjacent conductors is in opposite directions, the magnetic fields oppose each other and tend to cancel.

The magnetic field around a conductor may be considerably increased in strength by winding the wire into a coil. The field around each wire then combines with those of the adjacent

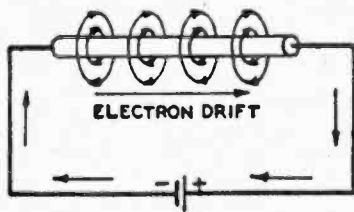

Figure 12. Showing the direction of the magnetic lines of force produced around a conductor carrying a current.

turns to form a total field through the coil which is concentrated along the axis of the coil and behaves externally in a way similar to the field of a bar magnet.

If the left hand is held so that the thumb is outstretched and parallel to the axis of a coil, with the fingers curled to indicate the direction of electron flow around the turns of the coil, the thumb then points in the direction of the north pole of the magnetic field.

The Magnetic Circuit In the magnetic circuit, the units which correspond to current, voltage, and resistance in the electrical circuit are flux, magnetomotive force, and reluctance.

Flux; Flux Density As a current is made up of a drift of electrons, so is a magnetic field made up of lines of force, and the total number of lines of force in a given magnetic circuit is termed the *flux*. The flux depends upon the material, cross section, and length of the magnetic circuit, and it varies directly as the current flowing in the circuit. The unit of flux is the *maxwell*, and the symbol is the Greek letter ϕ (phi).

Flux density is the number of lines of force per unit area. It is expressed in *gauss* if the unit of area is the square centimeter (1 gauss = 1 line of force per square centimeter), or in *lines per square inch*. The symbol for flux density is B if it is expressed in gausses, or B if expressed in lines per square inch.

Magnetomotive Force The force which produces a flux in a magnetic circuit is called *magnetomotive force*. It is abbreviated m.m.f. and is designated by the letter F . The unit of magnetomotive force is the *gilbert*, which is equivalent to $1.26 \times NI$, where N is the number of turns and I is the current flowing in the circuit in amperes.

The m.m.f. necessary to produce a given flux density is stated in gilberts per centimeter (H), or in ampere-turns per inch (H).

Reluctance Magnetic reluctance corresponds to electrical resistance, and is the property of a material that opposes the creation of a magnetic flux in the material. It is expressed in *oersteds* or in *rels*, and the symbol is the letter R . An oersted is the reluctance of 1 cubic centimeter of vacuum. A material has a reluctance of 1 rel when an m.m.f. of 1 ampere-turn (NI) generates a flux of 1 line of force in it. Combinations of reluctances are treated the same as resistances in finding the total effective reluctance. The *specific reluctance* of any substance is its reluctance per unit volume.

Except for iron and its alloys, most common materials have a specific reluctance very nearly the same as that of a vacuum, which, for all practical purposes, may be considered the same as the specific reluctance of air.

Ohm's Law for Magnetic Circuits The relations between flux, magnetomotive force, and reluctance are exactly the same as the relations between current, voltage, and resistance in the electrical circuit. These can be

stated as follows:

$$\phi = \frac{F}{R} \quad R = \frac{F}{\phi} \quad F = \phi R$$

where ϕ = flux, F = m.m.f., and R = reluctance. If F is in gilberts, R will be expressed in oersteds, but if F is in ampere-turns, then R will be in rels.

Permeability Permeability expresses the ease with which a magnetic field may be set up in a material as compared with the effort required in the case of air. Iron, for example, has a permeability of around 2000 times that of air, which means that a given amount of magnetizing effect produced in an iron core by a current flowing through a coil of wire will produce 2000 times the *flux density* that the same magnetizing effect would produce in air. It may be expressed by the ratio B/H or B/H . In other words,

$$\mu = \frac{B}{H} \text{ or } \mu = \frac{B}{H}$$

where μ is the permeability, B is the flux density in gausses, B is the flux density in lines per square inch, H is the m.m.f. in gilberts per centimeter, and H is the m.m.f. in ampere-turns per inch. These relations may also be stated as follows:

$$H = \frac{B}{\mu} \text{ or } H = \frac{B}{\mu}, \text{ and } B = H\mu \text{ or } B = H\mu$$

It can be seen from the foregoing that permeability is inversely proportional to the specific reluctance of a material.

Saturation Permeability is similar to *electric conductivity*. There is, however, one important difference: the permeability of magnetic materials is not independent of the magnetic current (flux) flowing through it, although electrical conductivity is substantially independent of the electric current in a wire. When the flux density of a magnetic conductor has been increased to the *saturation point*, a further increase in the magnetizing force will not produce a corresponding increase in flux density.

Calculations To simplify magnetic circuit calculations, a magnetization curve may be drawn for a given unit of material. Such a curve is termed a B-H curve, and is arrived at by experiment. B-H curves for most common magnetic materials are available in many reference books, so none will be given here.

Residual Magnetism; Retentivity The magnetism remaining in a material after the magnetizing force is removed is called *residual magnetism*.

Retentivity is the property which causes a magnetic material to have residual magnetism after having been magnetized.

Hysteresis; Coercive Force *Hysteresis* is the characteristic of a magnetic system which causes a loss of power due to the fact that a negative magnetizing force must be applied to reduce the residual magnetism to zero. This negative force is termed *coercive force*. By "negative" magnetizing force is meant one which is of the opposite polarity with respect to the original magnetizing force. Hysteresis loss is apparent in transformers and chokes by the heating of the core.

2-3 Alternating Current

To this point in the text, consideration has been given primarily to a current consisting of a steady flow of electrons in one direction. This type of current flow is known as *uni-directional* or *direct* current, abbreviated *d.c.* Equally as important

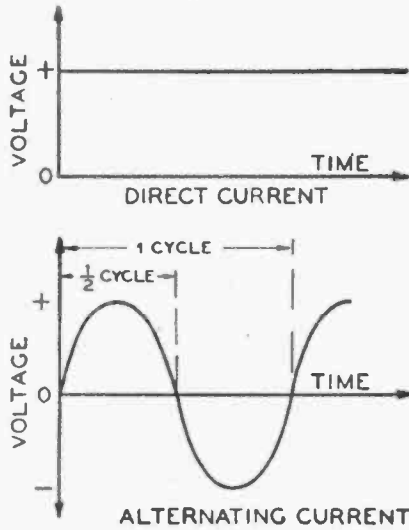

Figure 13.
ALTERNATING VOLTAGE AND DIRECT VOLTAGE.
Graphical comparison of unidirectional (d-c) voltage and alternating (a-c) voltage as plotted against time.

in radio work and more important in power practice is another and altogether different type of current, known as *alternating current* and abbreviated *a.c.* Power distribution from one point to another and into homes and factories is almost universally *a.c.* On the other hand, the plate supply to vacuum tubes is almost universally *d.c.*

Generation of Alternating Current Faraday discovered that if a conductor which forms part of a closed circuit is moved through a magnetic field so as to cut across the lines of force, a current will flow in the conductor. He also discovered that, if a conductor in a second closed circuit is brought near the first conductor and the current in the first one is varied, a current will flow in the second conductor. This effect is known as *induction*, and the currents so generated are *induced currents*. In the latter case it is the lines of force which are moving and cutting the second conductor, due to the varying current strength in the first conductor.

A current is induced in a conductor if there is a relative motion between the conductor and a magnetic field, its direction of flow depending upon the direction of the relative motion between the conductor and the field, and its strength depends upon the intensity of the field, the rate of cutting lines of force, and the number of turns in the conductor.

An alternating current is one which periodically rises from zero to a maximum in one direction, decreases to zero and changes its direction, rises to a maximum in the opposite direction, and decreases to zero again. (Refer to Figure 13.) This complete process is called a *cycle*, and from zero through a maximum and back to zero is an *alternation* or *half-cycle*. The number of times per second that the current goes through a complete cycle is called the *frequency*.

A machine that generates alternating current is termed an *alternator* or *a.c. generator*. Such a machine in its basic form is shown in Figure 14. It consists of two permanent magnets, M, the opposite poles of which face each other and are machined so that they have a common radius. Between these two poles, *north* (N) and *south* (S), a magnetic field exists. If a conductor in the form of C is so suspended that it can be freely rotated between the two poles, and if the opposite ends of conductor C are brought to collector rings, R, which are contacted by brushes (B), there will be a flow of alternating cur-

Figure 14.
Semi-schematic representation of the simplest form of the alternator.

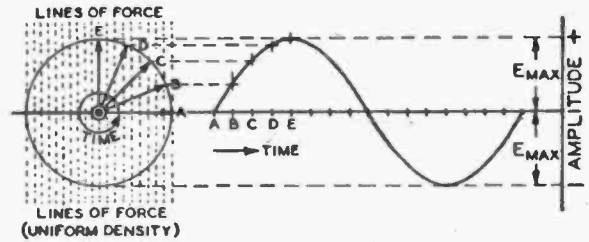
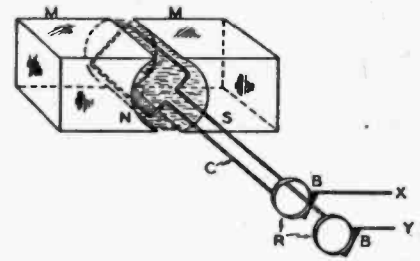

Figure 15.
Graph showing the output voltage of the alternator of Figure 14. The output waveform is called a "sine wave" for the reasons given in the text.

rent when conductor C is rotated. This current will flow through the collector rings R and brushes B to the external circuit, X-Y.

The field intensity between the two pole pieces is substantially constant over the entire area of the pole face. However, when the conductor is moving parallel to the lines of force at the top or bottom of the pole faces, no lines are being cut. As the conductor moves on across the pole face it cuts more and more lines of force for each unit distance of travel, until it is cutting the maximum number of lines when opposite the center of the pole. Therefore, zero current is induced in the conductor at the instant it is midway between the two poles, and maximum current is induced when it is opposite the center of the pole face. After the conductor has rotated through 180° it can be seen that its position with respect to the pole pieces will be exactly opposite to that when it started. Hence, the second 180° of rotation will produce an alternation of current in the opposite direction to that of the first alternation.

The current does *not* increase directly as the angle of rotation, but rather as the *sine* of the angle; hence, such a current has the mathematical form of a *sine wave*. Although most electrical machinery does not produce a strictly pure sine curve, the departures are usually so slight that the assumption can be regarded as fact for most practical purposes. All that has been said in the foregoing paragraphs concerning alternating current also is applicable to alternating voltage.

Why the voltage output of a conductor revolving in a magnetic field is a sine wave is made clear by reference to Figure 15.

The rotating arrow to the left represents a conductor rotating in a constant magnetic field of uniform density. The arrow also can be taken as a *vector* representing the strength of the magnetic field. This means that the length of the arrow is determined by the strength of the field (number of lines of force), which is constant. Now if the arrow is rotating at a constant rate (that is, with constant *angular velocity*), then the voltage developed across the conductor will be proportional to the rate at which it is cutting lines of force, which rate is proportional to the vertical distance between the tip of the arrow and the horizontal base line.

If EO is taken as unity or a voltage of 1, then the voltage (vertical distance from tip of arrow to the horizontal base line) at point C for instance may be determined simply by referring

to a table of sines and looking up the sine of the angle which the arrow makes with the horizontal, because in a right triangle the "side opposite is equal to the sine of the included angle times the hypotenuse."

When the arrow has traveled from A to point E, it has traveled 90 degrees or one quarter cycle. The other three quadrants are not shown because their complementary or mirror relationship to the first quadrant is obvious.

It is important to note that time units are represented by *degrees* or quadrants. The fact that AB, BC, CD, and DE are equal chords (forming equal quadrants) simply means that the arrow (conductor or vector) is traveling at a constant speed, because these points on the radius represent the passage of equal units of time.

The whole picture can be represented in another way, and its derivation from the foregoing is shown in Figure 15. The time base is represented by a straight line rather than by angular rotation. Points A, B, C, etc., represent the same units of time as before. When the voltage corresponding to each point is projected to the corresponding time unit, the familiar *sine curve* is the result.

The instantaneous value of voltage at any given instant can be calculated as follows:

$$e = E_{max} \sin 2\pi ft,$$

where *e* = the instantaneous voltage,

E = maximum crest value of voltage,

f = frequency in cycles per second, and

t = time in seconds.

The instantaneous current can be found from the same formula by substituting *i* for *e* and *I_{max}* for *E_{max}*. The formula then becomes:

$$i = I_{max} \sin 2\pi ft,$$

where *i* = the instantaneous current,

I = maximum crest value of current,

f = frequency in cycles per second, and

t = time in seconds.

Radians The term $2\pi f$ in the preceding equation should be thoroughly understood because it is of basic importance. Returning again to the rotating point of Figure 15, it can be seen that when this point leaves its horizontal position and begins its rotation in a counter-clockwise direction, through a complete revolution back to its initial starting point, it will have traveled through 360 electrical degrees. In electrical work,

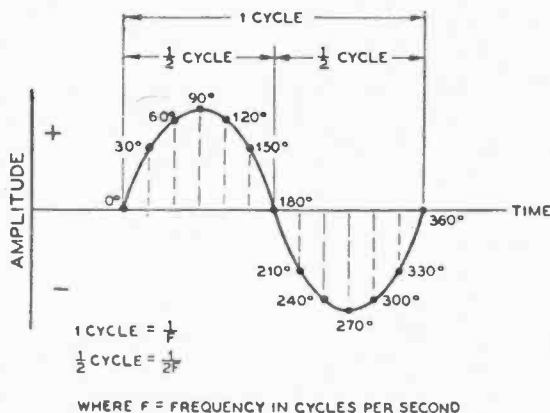

Figure 16.
THE SINE WAVE.

Illustrating one cycle of a sine-wave alternation. One complete cycle of alternation is broken up into 360 degrees. Then one-half cycle is 180 degrees, one-quarter cycle is 90 degrees, and so on down to the smallest possible division.

instead of referring to this movement in terms of degrees, it is customary to express the movement in terms of *radians*. Mathematically, a radian is an arc of the circle equal in length to the radius of the circle. There are 2π radians in 360 degrees, so that one radian is equivalent to 57.32 degrees. (See Figure 17.)

When the conductor in the simple alternator has moved through 2π radians it has generated one cycle. $2\pi f$ then represents one cycle, multiplied by the number of cycles per second (the frequency) of the alternating voltages or current, and is, therefore, the *angular velocity*. In technical literature $2\pi f$ is often replaced by ω , the Greek letter omega. Velocity multiplied by time gives the distance traveled, so $2\pi ft$ represents the *angular distance* through which the conductor has traveled, and since the instantaneous voltage or current is proportional to the sine of this angle, it is possible to calculate these quantities at any instant of time, provided that the wave very closely approximates a sine curve.

Frequency The frequency of an alternating current or voltage may be any value greater than zero up to millions of cycles per second. Up to about 20,000 cycles per second are considered audio frequencies, since all except those from zero to about 16 c.p.s. are audible to the human ear. The a.c. power which is supplied to homes and factories is generally 25, 50, or 60 c.p.s. Frequencies above 20,000 c.p.s. are known as radio frequencies. But they are usually spoken of in terms of *kilocycles*, rather than cycles, because the numbers become too large. When the frequency gets above a few thousand kilocycles, the term *megacycle* is used. A kilocycle is equal to 1000 cycles, and a megacycle equals 1,000,000 cycles. A conversion table for simplifying this terminology is given here:

- 1,000 cycles = 1 kilocycle. The abbreviation for kilocycle is *kc*.
- 1 cycle = 1/1,000 of a kilocycle, .001 *kc*. or 10^{-3} *kc*.
- 1 megacycle = 1,000 kilocycles, or 1,000,000 cycles, 10^3 *kc*. or 10^6 cycles.
- 1 kilocycle = 1/1000 megacycle, .001 megacycle, or 10^{-3} *Mc*. The abbreviation for megacycles is *Mc*.

Effective Value of Voltage and Current The instantaneous value of an alternating current or voltage varies throughout the cycle, so that the *effective* value of this current or voltage must be determined by comparing the a.c. heating effect with that of d.c. Thus, an alternating current will have an effective value of 1 ampere when it produces the same heat in a conductor as does 1 ampere of direct current.

This effective value is derived by taking the instantaneous values of current over a cycle of alternating current, squaring these values, taking an average of the squares, and then taking the square root of the average. By this procedure, the effective value becomes known as the *root mean square* or *r.m.s.* value. This is the value that is read on a.c. voltmeters and a.c. am-

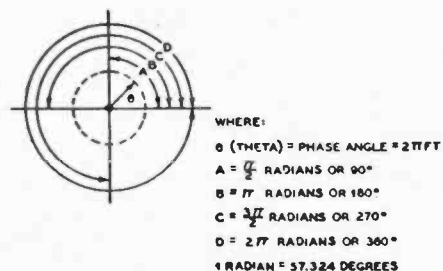

Figure 17.
ILLUSTRATING RADIAN NOTATION.

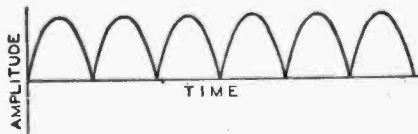

Figure 18.

FULL-WAVE RECTIFIED SINE WAVE.

Waveform obtained at the output of a full-wave rectifier having 100 per cent rectification efficiency. Each pulse has the same shape as one-half cycle of a sine wave. This type of current is known as pulsating direct current.

meters. The r.m.s. value is 70.7 (for sine waves only) per cent of the peak or maximum instantaneous value and is expressed as follows:

$$E_{\text{eff}} \text{ or } E_{r. \text{ m. s.}} = 0.707 \times E_{\text{max}}, \text{ or}$$

$$I_{\text{eff}} \text{ or } I_{r. \text{ m. s.}} = 0.707 \times I_{\text{max}}.$$

The following relations are extremely useful in radio and power work:

$$E_{r. \text{ m. s.}} = 0.707 \times E_{\text{max}}, \text{ and}$$

$$E_{\text{max}} = 1.414 \times E_{r. \text{ m. s.}}$$

Rectified Alternating Current or Pulsating Direct Current If an alternating current is passed through a full-wave rectifier, it emerges in the form of a current of varying amplitude which flows in one direction only. Such a current is known as *rectified a.c.* or *pulsating d.c.* A typical wave form of a pulsating direct current as would be obtained from the output of a full-wave rectifier is shown in Figure 18.

Measuring instruments designed for d.c. operation will not read the peak or instantaneous maximum value of the pulsating d.c. output from the rectifier; they will read only the *average value*. This can be explained by assuming that it could be possible to cut off some of the peaks of the waves, using the cut-off portions to fill in the spaces that are open, thereby obtaining an *average d.c.* value. A milliammeter and voltmeter connected to the adjoining circuit, or across the output of the rectifier, will read this average value. It is related to *peak* value by the following expression:

$$E_{\text{avg}} = 0.636 \times E_{\text{max}}$$

It is thus seen that the average value is 63.6 per cent of the peak value.

Relationship Between Peak, R.M.S. or Effective, and Average Values To summarize the three most significant values of an a.c. wave: the peak value is equal to 1.41 times the r.m.s. or effective, and the r.m.s. value is equal to 0.707 times the peak value;

the average value of a full-wave rectified a.c. wave is 0.636 times the peak value, and the average value of a rectified wave is equal to 0.9 times the r.m.s. value. This latter factor is of value in determining the voltage output from a power supply which operates with a choke-input filter system. If the input choke is of ample inductance, the d-c voltage output of a full wave power supply will be 0.9 times the r.m.s. a.c. output of the used secondary of the transformer (one-half secondary voltage in the case of a full-wave rectifier and the full secondary voltage in the case of bridge rectification) less the drop in the rectifier tubes and the resistance drop in the filter inductances.

2-4**Inductance**

In Section 2-3 a brief explanation of induction was given, and it would be well for the reader to review it at this point.

If a switch is inserted in the circuit shown in Figure 11, a

pulsating direct current can be produced by closing and opening the switch. When it is first closed, the current does not instantaneously rise to its maximum value, but builds up to it. While it is building up, the magnetic field is expanding around the conductor. Of course, this happens in a small fraction of a second. If the switch is then opened, the current dies down and the magnetic field contracts. This expanding and contracting field will induce a current in any other conductor that is part of a continuous circuit which it cuts. Such a field can be obtained in the way just mentioned by means of a vibrator interruptor, or by applying a.c. to the circuit in place of the battery. Varying the resistance of the circuit will also produce the same effect. This inducing of a current in a conductor due to a varying current in another conductor not in actual contact is called *electromagnetic induction*.

Self-induction If an alternating current flows through a coil the varying magnetic field around each turn cuts itself and the adjacent turn and *induces a voltage in the coil of opposite polarity to the applied e.m.f.* The amount of induced voltage depends upon the number of turns in the coil, the current flowing in the coil, and the number of lines of force threading the coil. The voltage so induced is known as a *counter-e.m.f.* or *back-e.m.f.*, and the effect is termed *self-induction*. When the applied voltage is building up, the counter-e.m.f. opposes the rise; when the applied voltage is decreasing, the counter-e.m.f. is of the same polarity and tends to maintain the current. Thus, it can be seen that self-induction tends to prevent any change in the current in the circuit.

The storage of energy in a magnetic field is expressed in *joules* and is equal to $(LI^2)/2$. (A joule is equal to 1 watt-second. L is defined immediately following.)

The Unit of Inductance; Inductance is usually denoted by the letter L, and is expressed in *henrys*. A coil has an inductance of 1 henry when a voltage of 1 volt is induced by a current change of 1 ampere

per second. The henry, while commonly used in audio frequency circuits, is too large for reference to inductance coils such as those used in radio frequency circuits; *millihenry* or *microhenry* is more commonly used, in the following manner:

1 *henry* = 1,000 *millihenrys*, or 10^3 *millihenrys*.

1 *millihenry* = 1/1,000 of a henry, .001 henry, or 10^{-3} henry.

1 *microhenry* = 1/1,000,000 of a henry, or .000001 henry, or 10^{-6} henry.

1 *microhenry* = 1/1,000 of a millihenry, .001 or 10^{-3} millihenrys.

1,000 *microhenrys* = 1 *millihenry*.

Mutual Induction When one coil is near another, a varying current in one will produce a varying magnetic field which cuts the turns of the other coil, inducing a current in it. This induced current is also varying, and will therefore induce another current in the first coil. This reaction between two coupled circuits is called *mutual induction*, and can be calculated and expressed in henrys. The symbol for mutual inductance is M. Two circuits thus joined are said to be *inductively coupled*.

The magnitude of the mutual inductance depends upon the shape and size of the two circuits, their positions and distances apart, and the permeability of the medium. The extent to which two inductors are coupled is expressed by a relation known as *coefficient of coupling*. This is the ratio of the mutual inductance actually present to the maximum possible value.

The formula for mutual inductance is $L = L_1 + L_2 + 2M$ when the coils are poled so that their fields add. When they are poled so that their fields buck, then $L = L_1 + L_2 - 2M$.

If a 3 henry coil and a 4 henry coil are placed so that there

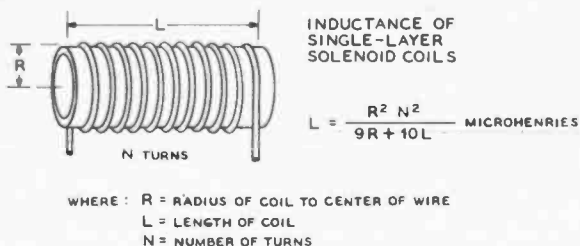

Figure 19.

METHOD OF CALCULATING INDUCTANCE.

Through the use of the equation and the sketch shown above the coil inductance can be calculated within approximately one per cent accuracy for the types of coils normally used in the range from perhaps 3 to 50 Mc.

is no coupling between them, then the combined inductance of the two in series will be 7 henrys. But if the coils are placed in inductive relation to each other, the inductance of the two in series will be either greater or less than 7 henrys, depending upon whether the polarity is such that the mutual inductance aids the self-inductance or bucks the self-inductance. If the total inductance of the two coils when coupled measured either 6 or 8 henrys, then the mutual inductance would be (from the formula) 1/2 henry.

Inductors in Parallel Inductors in parallel are combined exactly as are resistors in parallel, provided that they are far enough apart so that the mutual inductance is entirely negligible.

Inductors in Series Inductors in series are additive, just as are resistors in series, again provided that no mutual inductance exists. In this case, the total inductance L is:

$$L = L_1 + L_2 + \dots \text{etc.}$$

Where mutual inductance does exist:

$$L = L_1 + L_2 + 2M,$$

where M is the mutual inductance.

This latter expression assumes that the coils are connected in such a way that all flux linkages are in the same direction, i.e., additive. If this is not the case and the mutual linkages subtract from the self-linkages, the following formula holds:

$$L = L_1 + L_2 - 2M,$$

where M is the mutual inductance.

Core Material Ordinary magnetic cores cannot be used for radio frequencies because the eddy current and hysteresis losses in the core material become enormous as the frequency is increased. The principal use for magnetic cores is in the audio-frequency range below approximately 15,000 cycles, whereas at very low frequencies (50 to 60 cycles) their use is mandatory if an appreciable value of inductance is desired.

An air core inductor of only 1 henry inductance would be quite large in size, yet values as high as 500 henrys are commonly available in small iron core chokes. The inductance of a coil with a magnetic core will vary with the amount of current (both a.c. and d.c.) which passes through the coil. For this reason, iron core chokes that are used in power supplies have a certain inductance rating at a predetermined value of d.c.

The permeability of air does not change with flux density; so the inductance of iron core coils often is made less dependent upon flux density by making part of the magnetic path air, instead of utilizing a closed loop of iron. This incorporation of an air gap is necessary in many applications of iron core

coils, particularly where the coil carries a considerable d.c. component. Because the permeability of air is so much lower than that of iron, the air gap need comprise only a small fraction of the magnetic circuit in order to provide a substantial proportion of the total reluctance.

One exception to the statement that metal core inductors are highly inefficient at radio frequencies is in the use of powdered iron cores in some types of intermediate frequency transformers. These cores are made of very fine particles of powdered iron, which are first treated with an insulating compound so that each particle is insulated from the other. These particles are then molded into a solid core around which the wire is wound. Eddy current losses are greatly reduced, with the result that these special iron cores are entirely practical in circuits which operate up to 100 Mc. in frequency.

Inductive Reactance As was previously stated, when an alternating current flows through an inductor a back- or counter-electromotive force is developed; this force opposes any change in the initial e.m.f. This property of an inductor causes it to offer opposition or impedance to a change in current. The measure of impedance offered by an inductor to an alternating current of a given frequency is known as its inductive reactance. This is expressed as X_L :

$$X_L = 2\pi fL,$$

where X_L = inductive reactance expressed in ohms.

$$\pi = 3.1416 \quad (2\pi = 6.283),$$

f = frequency in cycles,

L = inductance in henrys.

Inductive Reactance at R.F. It is very often necessary to compute inductive reactance at radio frequencies. The same formula may be used,

but to make it less cumbersome the inductance is expressed in millihenrys and the frequency in kilocycles. For higher frequencies and smaller values of inductance, frequency is expressed in megacycles and inductance in microhenrys. The basic equation need not be changed, since the multiplying factors for inductance and frequency appear in numerator and denominator, and hence are cancelled out. However, it is not possible in the same equation to express L in millihenrys and f in cycles without conversion factors.

Should it become desirable to know the value of inductance necessary to give a certain reactance at some definite frequency, a transposition of the original formula gives:

$$L = X_L \div (2\pi f),$$

or when X_L and L are known,

$$f = \frac{X_L}{2\pi L}.$$

2-5 Electrostatic Storage of Energy

So far we have dealt only with the storage of energy in an electromagnetic field in the form of an inductance.

Electrical energy can also be stored in an electrostatic field. A device capable of storing energy in such a field is called capacitor (in earlier usage the term condenser was frequently used but the IRE standards call for the use of capacitor instead of condenser) and is said to have a certain capacitance. The energy stored in an electrostatic field is expressed in joules (watt seconds) and is equal to $CE^2/2$, where C is the capacitance in farads (a unit of capacitance to be discussed) and E is the potential in volts. The charge is equal to CE, the charge being expressed in coulombs.

Capacitance and Capacitors Two metallic plates separated from each other by a thin layer of insulating material (called a dielectric, in this case), be-

come a *capacitor*. When a source of d-c potential is momentarily applied across these plates, they may be said to become charged. If the same two plates are then joined together momentarily by means of a wire, the capacitor will *discharge*.

When the potential was first applied, electrons immediately flowed from one plate to the other through the battery or such source of d-c potential as was applied to the capacitor plates. However, the circuit from plate to plate in the capacitor was *incomplete* (the two plates being separated by an insulator) and thus the electron flow ceased, meanwhile establishing a shortage of electrons on one plate and a surplus of electrons on the other.

Remember that when a deficiency of electrons exists at one end of a conductor, there is always a tendency for the electrons to move about in such a manner as to re-establish a state of balance. In the case of the capacitor herein discussed, the surplus quantity of electrons on one of the capacitor plates cannot move to the other plate because the circuit has been broken; that is, the battery or d-c potential was removed. This leaves the capacitor in a *charged* condition; the capacitor plate with the electron deficiency is *positively* charged, the other plate being *negative*.

In this condition, a considerable stress exists in the insulating material (dielectric) which separates the two capacitor plates, due to the mutual attraction of two unlike potentials on the plates. This stress is known as *electrostatic* energy, as contrasted with *electromagnetic* energy in the case of an inductor. This charge can also be called *potential energy* because it is capable of performing work when the charge is released through an external circuit.

In case it is difficult for the reader to understand why the charge is proportional to the voltage but the energy is proportional to the voltage squared, the following analogy may make things clear.

The charge represents a definite amount of electricity, a given number of electrons. The potential energy possessed by these electrons depends not only upon their number, but also upon their potential or voltage.

Compare the electrons to water, and two capacitors to standpipes, a 1 μ f. capacitor to a standpipe having a cross section of 1 square foot and a 2 μ f. capacitor to a standpipe having a cross section of 2 square feet. The charge will represent a given volume of water, as the "charge" simply indicates a certain number of electrons. Suppose the water is equal to 5 gallons.

Now the potential energy, or capacity for doing work, of the 5 gallons of water will be twice as great when confined to the 1 sq. ft. standpipe as when confined to the 2 sq. ft. standpipe. Yet the volume of water, or "charge" is the same in either case.

Likewise a 1 μ f. capacitor charged to 1000 volts possesses twice as much potential energy as does a 2 μ f. capacitor charged to 500 volts, though the *charge* is the same in either case.

The Unit of Capacitance: The Farad If the external circuit of the two capacitor plates is completed by joining the terminals together with a piece of wire, the electrons will rush immediately from one plate to the other through the external circuit and establish a state of equilibrium. This latter phenomenon explains the *discharge* of a capacitor. The amount of stored energy in a charged capacitor is dependent upon the charging potential, as well as a factor which takes into account the *size* of the plates, *dielectric thickness*, *nature* of the dielectric, and the *number* of plates. This factor, which is determined by the foregoing, is called the *capacitance* of a capacitor and is expressed in *farads*.

The farad is such a large unit of capacitance that it is rarely

used in radio calculations, and the following more practical units have, therefore, been chosen:

1 *microfarad* = 1/1,000,000 of a farad, or .000001 farad, or 10^{-6} farads.

1 *micro-microfarad* = 1/1,000,000 of a microfarad, or .000001 microfarad, or 10^{-8} microfarads.

1 *micro-microfarad* = one-millionth of one-millionth of a farad, or 10^{-12} farads.

If the capacitance is to be expressed in *microfarads* in the equation given under *energy storage*, the factor C would then have to be divided by 1,000,000, thus:

$$\text{Stored energy in joules} = \frac{C \times E^2}{2 \times 1,000,000}$$

This storage of energy in a capacitor is one of its very important properties, particularly in those capacitors which are used in power supply filter circuits.

Dielectric Constant The capacitance of a capacitor is greatly affected by the thickness and nature of the dielectric separation between plates. Certain materials offer a greater capacitance than others, depending upon their physical makeup and chemical constitution. This property is expressed by a constant K, called the dielectric constant.

Dielectric Breakdown If the charge becomes too great for a given thickness of a certain dielectric, the capacitor will break down, i.e., the dielectric will puncture. It is for this reason that capacitors are rated in the manner of the amount of voltage they will safely withstand as well as the capacitance in microfarads. This rating is commonly expressed as the *d.c. working voltage*.

Calculation of Capacitance The capacitance of two parallel plates is given with good accuracy by the following formula:

$$C = 0.2248 \times K \times \frac{A}{t}$$

where C = capacitance in micro-microfarads,
 K = dielectric constant of spacing material,
 A = area of dielectric in square inches,
 t = thickness of dielectric in inches.

This formula indicates that the capacitance is directly proportional to the area of the plates and inversely proportional

TABLE OF DIELECTRIC MATERIALS			
MATERIAL	DIELECTRIC CONSTANT-10 MC.	POWER FACTOR-10 MC.	SOFTENING POINT
ANILINE-FORMALDEHYDE RESIN	3.4	0.004	280°
CASTOR OIL	4.87		
CELLULOSE ACETATE	3.4	0.04	180°
GLASS, WINDOW	8-9	POOR	2000°
GLASS, PYREX	4.5	0.02	
METHYL-METHACRYLATE-LUCITE	2.6	0.007	160°
MICA	5.4	0.0003	
MYCALEX, MYKROY	7.0	0.002	650°
PHENOL-FORMALDEHYDE, LOW-LOSS YELLOW	5.0	0.015	270°
PHENOL-FORMALDEHYDE, BLACK BAKELITE	5.3	0.03	350°
PORCELAIN	7.0	0.005	2800°
POLYETHYLENE	2.25	0.0003	220°
POLYSTYRENE	2.55	0.0002	175°
QUARTZ, FUSEO	3.8	0.0002	2800°
RUBBER, HARD-EBONITE	2.8	0.007	150°
STEATITE	8.1	0.003	2700°
SULFUR	3.6	0.003	238°
TITANIUM DIOXIDE	100-175	0.0008	2700°
TRANSFORMER OIL	2.2	0.003	
UREA-FORMALDEHYDE	5.0	0.05	280°
VINYL RESINS	4.0	0.02	200°
WOOD, MAPLE	4.4	POOR	

Figure 20.

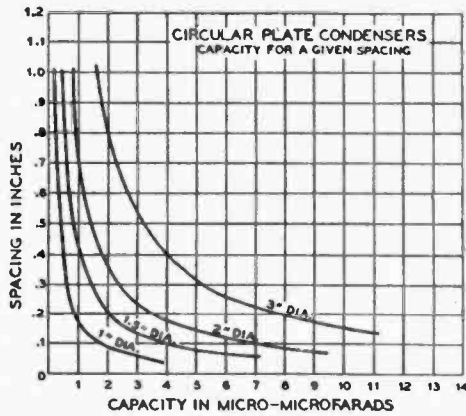

Figure 21.

Through the use of this chart it is possible to determine the approximate plate diameter and spacing for a circular-plate capacitor of the type commonly used as a neutralizing capacitor on medium- and high-power r-f amplifiers. The capacitance given is for a dielectric of air and the spacing given is between the adjacent faces of the two plates.

to the thickness of the dielectric (spacing between the plates). This simply means that when the area of the plate is doubled, the spacing between plates remaining constant, the capacitance will be doubled. Also, if the area of the plates remains constant, and the plate spacing is doubled, the capacitance will be reduced to half.

The above equation also shows that capacitance is directly proportional to the dielectric constant of the spacing material. A capacitor that has a capacitance of 100 $\mu\mu\text{fd.}$ in air would have a capacitance of 467 $\mu\mu\text{fd.}$ when immersed in castor oil, because the dielectric constant of castor oil is 4.67 times as great as the dielectric constant of air.

Where the area of the plates is definitely set, and when it is desired to know the spacing needed to secure a required capacitance,

$$t = \frac{A \times 0.2248 \times K}{C}$$

where all units are expressed just as in the preceding formula. This formula is not confined to capacitors having only square or rectangular plates, but also applies when the plates are circular in shape. The only change will be the calculation of the area of such circular plates; this area can be computed by squaring the radius of the plate, then multiplying by 3.1416, or "pi." Expressed as an equation:

$$A = 3.1416 \times r^2,$$

where r = radius in inches.

The capacitance of a multi-plate capacitor can be calculated by taking the capacitance of one section and multiplying this by the number of dielectric spaces. In such cases, however, the formula gives no consideration to the effects of edge capacitance; so the capacitance as calculated will not be entirely accurate. These additional capacitances will be but a small part of the effective total capacitance, particularly when the plates

are reasonably large and thin, and the final result will, therefore, be within practical limits of accuracy.

Equations for calculating capacitances of capacitors in parallel connections are the same as those for resistors in series:

$$C = C_1 + C_2, \text{ etc.}$$

Capacitors in series connection are calculated in the same manner as are resistors in parallel connection.

The formulas are repeated: (1) For two or more capacitors of unequal capacitance in series:

$$C = \frac{1}{\frac{1}{C_1} + \frac{1}{C_2} + \frac{1}{C_3}}$$

$$\text{or } \frac{1}{C} = \frac{1}{C_1} + \frac{1}{C_2} + \frac{1}{C_3}$$

(2) Two capacitors of unequal capacitance in series:

$$C = \frac{C_1 \times C_2}{C_1 + C_2}$$

(3) Three capacitors of equal capacitance in series:

$$C = \frac{C_1}{3} \text{ where } C_1 \text{ is the common capacitance.}$$

(4) Three or more capacitors of equal capacitance in series:

$$C = \frac{\text{Value of common capacitance}}{\text{Number of capacitors in series}}$$

(5) Six capacitors in series parallel:

$$C = \frac{1}{\frac{1}{C_1} + \frac{1}{C_2}} + \frac{1}{\frac{1}{C_3} + \frac{1}{C_4}} + \frac{1}{\frac{1}{C_5} + \frac{1}{C_6}}$$

Capacitive Reactance It has been explained that inductive reactance is the measure of the ability of an inductor to offer impedance to the flow of an alternating current.

Capacitors have a similar property although in this case the opposition is to the voltage which acts to charge the capacitor. This property is called *capacitive reactance* and is expressed as follows:

$$X_c = \frac{1}{2\pi fC}$$

where X_c = capacitive reactance in ohms,

π = 3.1416,

f = frequency in cycles,

C = capacitance in farads.

Capacitive Reactance at R. F. Here again, as in the case of inductive reactance, the units of capacitance and frequency can be converted into smaller units

for practical problems encountered in radio work. The equation may be written:

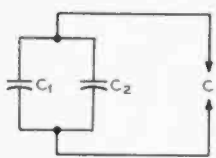

PARALLEL CAPACITORS

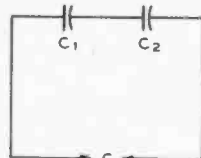

SERIES CAPACITORS

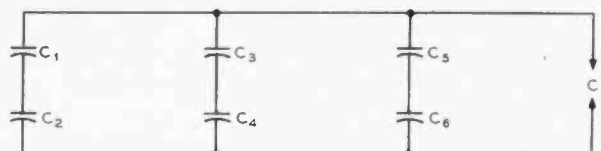

CAPACITORS IN SERIES-PARALLEL

FIGURE 22

FIGURE 23

$$X_c = \frac{1,000,000}{2 \pi f C}$$

where f = frequency in megacycles,

C = capacitance in micro-microfarads.

In the design of filter circuits, it is often convenient to express frequency (f) in *cycles* and capacitance (C) in *microfarads*, in which event the same formula applies:

Capacitors in A-C and D-C Circuits When a capacitor is connected into a direct-current circuit, it will block the d.c., or stop the flow of current. Beyond the initial movement of electrons during the period when the capacitor is being charged, there will be no flow of current because the circuit is effectively broken by the dielectric of the capacitor.

Strictly speaking, a very small current may actually flow because the dielectric of the capacitor may not be a perfect insulator. This minute current flow is the leakage current previously referred to and is dependent upon the internal d-c resistance of the capacitor. This leakage current is usually quite noticeable in most types of electrolytic capacitors.

When an alternating current is applied to a capacitor, the capacitor will charge and discharge a certain number of times per second in accordance with the frequency of the alternating voltage. The electron flow in the charge and discharge of a capacitor when an a-c potential is applied constitutes an alternating current, in effect. It is for this reason that a capacitor will pass an alternating current yet offer practically infinite opposition to a direct current. These two properties are repeatedly in evidence in a radio circuit.

Voltage Rating of Capacitors in Series Any good paper dielectric filter capacitor has such a high internal resistance (indicating a good dielectric) that the exact resistance will vary considerably from capacitor to capacitor even though they are made by the same manufacturer and are of the same rating. Thus, when 1000 volts d.c. is connected across two 1- μ fd. 500-volt capacitors in series, the chances are that the voltage will divide unevenly and one capacitor will receive more than 500 volts and the other less than 500 volts.

Voltage Equalizing Resistors By connecting a half-megohm 1-watt carbon resistor across each capacitor, the voltage will be equalized because the resistors act as a voltage divider, and the internal resistances of the capacitors are so much higher (many megohms) that they have but little effect in disturbing the voltage divider balance.

Carbon resistors of the inexpensive type are not particularly accurate (not being designed for precision service); therefore it is advisable to check several on an accurate ohmmeter to find two that are as close as possible in resistance. The exact resistance is unimportant, just so it is the same for the two resistors used.

Capacitors in Series on A.C. When two capacitors are connected in series, *alternating* voltage pays no heed to the relatively high internal resistance of each capacitor, but divides across the capacitors in inverse proportion to the *capacitance*. Because, in addition to the d.c. across a capacitor in a filter or audio amplifier circuit there is usually an a-c or a-f voltage component, it is inadvisable to series-connect capacitors of unequal capacitance even if dividers are provided to keep the d.c. within the ratings of the individual capacitors.

For instance, if a 500-volt 1- μ fd. capacitor is used in

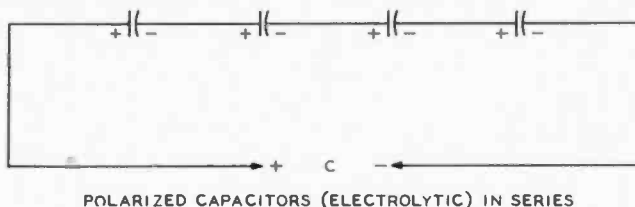

POLARIZED CAPACITORS (ELECTROLYTIC) IN SERIES

FIGURE 24

series with a 4- μ fd. 500-volt capacitor across a 250-volt a.c. supply, the 1- μ fd. capacitor will have 200 volts a.c. across it and the 4- μ fd. capacitor only 50 volts. An equalizing divider to do any good in this case would have to be of very low resistance because of the comparatively low impedance of the capacitors *to a.c.* Such a divider would draw excessive current and be impracticable.

The safest rule to follow is to use only capacitors of the same capacitance and voltage rating and to install matched high resistance proportioning resistors across the various capacitors to equalize the d-c voltage drop across each capacitor. This holds regardless of how many capacitors are series-connected.

Electrolytic Capacitors Electrolytic capacitors use a very thin film of oxide as the dielectric, and are polarized; that is, they have a positive and a negative terminal which must be properly connected in a circuit; otherwise, the oxide will break down and the capacitor will overheat. The unit then will no longer be of service. When electrolytic capacitors are connected in series, the positive terminal is always connected to the positive lead of the power supply; the negative terminal of the capacitor connects to the positive terminal of the *next* capacitor in the series combination. The method of connection for electrolytic capacitors in series is shown in Figure 24.

Similar electrolytic capacitors, of the same capacitance and made by the same manufacturer, have more nearly uniform internal resistance, though it still will vary considerably. However, the variation is not nearly as great as encountered in paper capacitors, and the lowest d.c. voltage is across the weakest (leakiest) electrolytic capacitor of a series group.

As an electrolytic capacitor begins to show signs of breaking down from excessive voltage, the leakage current goes up, which tends to heat the capacitor and aggravate the condition. However, when used in series with one or more others, the lower resistance (higher leakage current) tends to put less d-c voltage on the weakening capacitor and more on the remaining ones. Thus, the capacitor with the *lowest* leakage current, usually the *best* capacitor, has the highest voltage across it. For this reason, dividing resistors are not essential across series-connected electrolytic capacitors.

2-6 Circuits Containing Reactance and Resistance

Phase When an alternating current flows through a purely resistive circuit, it will be found that the current will go through maximum and minimum in perfect step with the voltage. In this case the current is said to be in *step* or *in phase* with the voltage. For this reason, Ohm's law will apply equally well for a.c. or d.c. where pure resistances are concerned, provided that the same values of the wave (either peak or r.m.s.) for both voltage and current are used in the calculations.

If a circuit has capacitance or inductance or both, in addition to resistance, the current does not reach a maximum at the same instant as the voltage; therefore Ohm's law will *not*

apply. It has been stated that inductance tends to resist any change in current; when an inductance is present in a circuit through which an alternating current is flowing, it will be found that the current will reach its maximum *behind* or later than the voltage. In electrical terms, the current will *lag* behind the voltage, or, conversely, the voltage will *lead* the current.

If the circuit is *purely inductive*, i.e., if it contains neither resistance nor capacitance, the current *lags* the voltage by 90 degrees as in Figure 25. The angle will be less than 90 degrees if resistance is in the circuit.

When pure *capacitance* alone is present in an a.c. circuit (no inductance or resistance of any kind), the opposite effect will be encountered; the current will *lead* the voltage by 90 degrees. The presence of resistance in the circuit will tend to decrease this angle.

Comparison of Inductive to Capacitive Reactance with Changing Frequency

From the equation for *inductive reactance*, it is seen that as the frequency becomes greater the reactance increases in a corresponding manner. The reactance is doubled when the frequency is doubled. If the reactance is to be very large when the frequency is low, the value of inductance must be very large.

The equation for capacitive reactance shows that the reactance varies *inversely* with frequency and capacitance. With a fixed value of capacitance, the reactance will become less as the frequency increases. When the frequency is fixed, the reactance will be greater as the capacitance is lowered.

A comparison of the two types of reactance, inductive and capacitive, shows that in one case (inductive) the reactance *increases* with frequency, whereas in the other (capacitive) the reactance *decreases* with frequency.

Reactance and Resistance in Combination

When a circuit includes a capacitance or an inductance or both, in addition to a resistance, the simple calculations of Ohm's law will *not* apply when the total impedance to alternating current is to be determined. Reference is here made to the passage of an *alternating current* through the circuit; the reactance must be considered in addition to the d.c. resistance because reactance offers an opposition to the flow of alternating current.

When alternating current passes through a circuit which contains only a capacitor, the voltage and current relations are as follows:

$$E = IX_c, \text{ and } I = \frac{E}{X_c}$$

where E = voltage,
I = current in amperes,

$$X_c = \text{capacitive reactance or } \frac{1}{2\pi fC}$$

(expressed in ohms).

Power Factor It should now be apparent to the reader that in such circuits that have reactance as well as resistance, it will not be possible to calculate the power as in a d-c circuit or as in an a-c circuit in which current and voltage are in phase. The reactive components cause the voltage and current to reach their maximums at different times, as was explained under *Phase*, and to calculate the power in such a circuit we must use a value called the *power factor* in our computations.

The *power factor* in a resistive-reactive a-c circuit may be

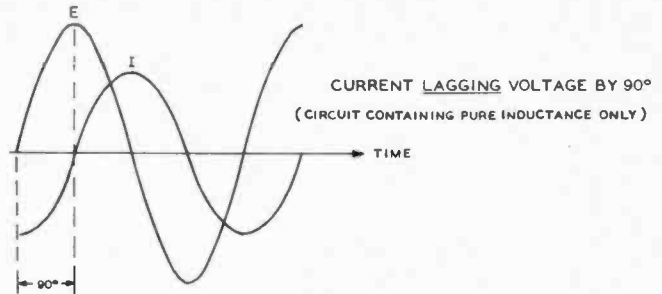

Figure 25. Showing the manner in which the current lags the voltage in an a-c circuit containing pure inductance only. The lag is equal to one-quarter cycle or 90 degrees.

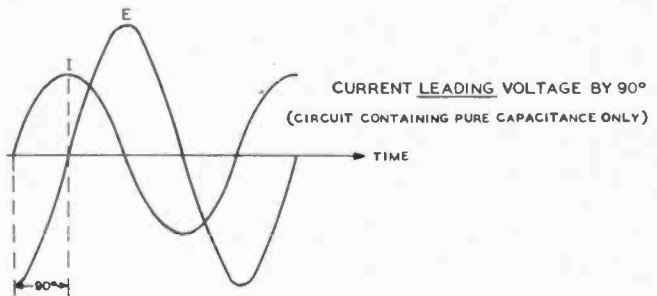

Figure 26. Showing the manner in which the current leads the voltage in an a-c circuit containing pure capacitance only. The lead is equal to one-quarter cycle or 90 degrees.

expressed as the *actual watts* (as measured by a watt-meter) divided by the product of voltage and current or:

$$\frac{W}{E \times I}$$

where W = watts as measured,
E = voltage (r.m.s.)
I = current in amperes (r.m.s.)

Stated in another manner:

$$\frac{W}{E \times I} = \cos\theta$$

The character θ is the angle of phase difference between current and voltage. The product of volts times amperes gives the *apparent power* of the circuit, and this must be multiplied by the $\cos\theta$ to give the *actual power*. This factor $\cos\theta$ is called the *power factor* of the circuit.

When the current and voltage are in phase this factor is equal to 1. Resonant or purely resistive circuits are then said to have unity power factor, in which case:

$$W = E \times I, W = I^2R, W = \frac{E^2}{R}$$

Applying Ohm's Law to Alternating Current

Ohm's law applies equally to direct or alternating current, *provided* the circuits under consideration are purely resistive, that is, circuits which have neither inductance (coils) nor capacitance (capacitors). Problems which involve tube filaments, drop resistors, electric lamps, heaters or similar resistive devices can be solved from Ohm's law, regardless of whether the current is direct or alternating. When a capacitor or coil is made a part of the circuit, a property common to either, called *reactance*, must be taken into consideration.

When the circuit contains inductance only, yet with the same conditions as above, the formula is as follows:

$$E = IX_L, \text{ and } I = \frac{E}{X_L}$$

where E = voltage,
 I = current in amperes,
 X_L = inductive reactance or $2\pi fL$
 (expressed in ohms).

When a circuit has resistance, capacitive reactance, and inductive reactance in series, the effective total opposition to the alternating current flow is known as the impedance of the circuit. Stated otherwise, impedance of a circuit is the vector sum of the resistance and the difference between the two reactances, the latter being designated as the net reactance.

$$Z = \sqrt{r^2 + (X_L - X_C)^2} \text{ or}$$

$$Z = \sqrt{r^2 + \left(2\pi fL - \frac{1}{2\pi fC}\right)^2}$$

where Z = impedance in ohms,
 r = resistance in ohms,
 X_L = inductive reactance
 ($2\pi fL$) in ohms,

X_C = capacitive reactance $\left(\frac{1}{2\pi fC}\right)$
 in ohms.

An example will serve to clarify the relationship of resistance and reactance to the total impedance. If a 10-henry choke, a 2- μ fd. capacitor, and a resistance of 10 ohms (which is represented by the d-c resistance of the choke) are all connected in series across a 60-cycle source of voltage:

for reactance $X_L = 6.28 \times 60 \times 10 = 3,750$ ohms (approx.),

$$X_C = \frac{1,000,000}{6.28 \times 60 \times 2} = 1,300 \text{ ohms (approx.)}$$

r = 10 ohms

Substituting these values in the impedance equation:

$$Z = \sqrt{10^2 + (3750 - 1300)^2} = 2450 \text{ ohms.}$$

This is nearly 250 times the value of the d-c resistance of 10 ohms. The subject of impedance is more fully covered under Resonant Circuits.

In actual practice the iron-core choke would act as though the resistance were somewhat more than 10 ohms (the value as read on an ohmmeter) because on a.c. there would also be core losses, which show up (produce the same effect as) additional d-c resistance in the winding. However, to simplify the foregoing problem the effect of core losses was ignored.

2-7 Resonant Circuits

The reader is advised to review at this point the subject matter on inductance, capacitance, and alternating current, in order that he may be able to gain a complete understanding of the action of resonant circuits. Once the basic conception of the foregoing has been mastered, the more complex circuits in which they appear in combination will present no great problem.

Figure 27 shows an inductance, a capacitance, and a resistance arranged in series, with a variable frequency source, E, of a.c. applied across the combination.

Some resistance is always present in a circuit because it is possessed in some degree by both the inductor and the capacitor. If the frequency of the alternator E is varied from nearly zero to some high frequency, there will be one particular frequency at which the inductive reactance and capacitive reactance will be equal. This is known as the resonant frequency, and in a series circuit it is the frequency at which the circuit current will be a maximum. Such series resonant circuits are



Figure 27. Schematic of a series-resonant circuit containing resistance.

chiefly used when it is desirable to allow a certain frequency to pass through the circuit (low impedance to this frequency), while at the same time the circuit is made to offer considerable opposition to currents of other frequencies.

If the values of inductance and capacitance both are fixed, there will be only one resonant frequency.

For mechanical reasons, it is more common to change the capacitance rather than the inductance when a circuit is tuned, yet the inductance can be made variable if desired.

In the following table there are five radically different ratios of L to C (inductance to capacitance) each of which satisfies the resonant condition, $X_L = X_C$. When the frequency is constant, L must increase and C must decrease in order to give equal reactance. Figure 28 shows how the two reactances change with frequency; this illustration will greatly aid in clarifying this discussion.

If both the inductance and capacitance are made variable, the circuit may then be changed or tuned, so that a number of combinations of inductance and capacitance can resonate at the same frequency. This can be more easily understood when one considers that inductive reactance and capacitive reactance travel in opposite directions as the frequency is changed. For example, if the frequency were to remain constant and the values of inductance and capacitance were then changed, the following combinations would have equal reactance:

Frequency is constant at 60 cycles.

L is expressed in henrys.

C is expressed in microfarads (.000001 farad.)

L	X_L	C	X_C
.265	100	26.5	100
2.65	1,000	2.65	1,000
26.5	10,000	.265	10,000
265.00	100,000	.0265	100,000
2,650.00	1,000,000	.00265	1,000,000

Frequency of Resonance From the formula for resonance,

$$2\pi fL = \frac{1}{2\pi fC}, \text{ the resonant frequency}$$

can readily be solved. In order to isolate f on one side of the equation, merely multiply both sides by $2\pi f$, thus giving:

$$4\pi^2 f^2 L = \frac{1}{C}$$

Divided by the quantity $4\pi^2 L$, the result is:

$$f^2 = \frac{1}{4\pi^2 LC}$$

Then, by taking the square root of both sides:

$$f = \frac{1}{2\pi \sqrt{LC}}$$

where f = frequency in cycles,
 L = inductance in henrys,
 C = capacitance in farads.

It is more convenient to express L and C in smaller units,

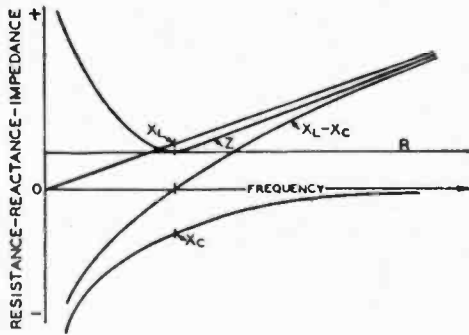

Figure 28.
SERIES-RESONANT CIRCUIT.
Variation in reactance and net impedance of a series-resonant circuit with changing frequency. The four short vertical lines are drawn at the point of resonance in the circuit.

especially in making radio-frequency calculations; f can also be expressed in megacycles or kilocycles. A very useful group of such formulas is:

$$f^2 = \frac{25,330}{LC} \text{ or } L = \frac{25,330}{f^2 C} \text{ or } C = \frac{25,330}{f^2 L}$$

where f = frequency in megacycles,
 L = inductance in microhenrys,
 C = capacitance in micromicrofarads.

Impedance of Series Resonant Circuits The impedance across the terminals of a series resonant circuit (Figure 27) is:

$$Z = \sqrt{r^2 + (X_L - X_C)^2}$$

where Z = impedance in ohms,
 r = resistance in ohms,
 X_C = capacitive reactance in ohms,
 X_L = inductive reactance in ohms.

From this equation, it can be seen that the impedance is equal to the vector sum of the circuit resistance and the difference between the two reactances. Since at the resonant frequency X_L equals X_C , the difference between them (Figure 28) is obviously zero, so that at resonance the impedance is simply equal to the resistance of the circuit; therefore, because the resistance of most normal radio-frequency circuits is of a very low order, the impedance is also low.

At frequencies higher and lower than the resonant frequency, the difference between the reactances will be a definite quantity and will add with the resistance to make the impedance higher and higher as the circuit is tuned off the resonant frequency.

If X_C should be greater than X_L , then the term $(X_L - X_C)$ will give a negative number. However, this is nothing to worry about because when the difference is squared the product is always positive. This means that the smaller reactance is subtracted from the larger, regardless of whether it be capacitive or inductive, and the difference squared.

Current and Voltage in Series Resonant Circuits Formulas for calculating currents and voltages in a series resonant circuit are similar to those of

Ohm's law.

$$I = \frac{E}{Z} \quad E = IZ$$

The complete equations:

$$I = \frac{E}{\sqrt{r^2 + (X_L - X_C)^2}}$$

$$E = I \sqrt{r^2 + (X_L - X_C)^2}$$

Inspection of the above formulas will show the following to apply to series resonant circuits: When the impedance is low, the current will be high; conversely, when the impedance is high, the current will be low.

Since it is known that the impedance will be very low at the resonant frequency, it follows that the current will be a maximum at this point. If a graph is plotted of the current against the frequency either side of resonance, the resultant curve becomes what is known as a *resonance curve*. Such a curve is shown in Figure 29, the frequency being plotted against *current* in the series resonant circuit.

Several factors will have an effect on the shape of this resonance curve, of which resistance and L-to-C ratio are the important considerations. The curves B and C in Figure 29 show the effect of adding increasing values of resistance to the circuit. It will be seen that the peaks become less and less prominent as the resistance is increased; thus, it can be said that the *selectivity* of the circuit is thereby *decreased*. Selectivity in this case can be defined as the ability of a circuit to discriminate against frequencies adjacent to the resonant frequency.

Voltage Across Coil and Capacitor in Series Circuit Because the a-c or r-f voltage across a coil and capacitor is proportional to the reactance (for a given current), the actual voltages across the coil and across the capacitor may be many times greater than the terminal voltage of the circuit. Furthermore, since the individual reactances can be very high, the voltage across the capacitor, for example, may be high enough to cause flashover, even though the applied voltage is of a value considerably below that at which the capacitor is rated.

Circuit Q—Sharpness of Resonance An extremely important property of a capacitor or an inductor is its factor-of-merit, more generally called its Q . It is this factor, Q , which primarily determines the sharpness of resonance of a tuned circuit. This factor can be expressed as the ratio of the reactance to the resistance, as follows:

$$Q = \frac{2\pi fL}{R}$$

where R = total resistance.

The actual resistance in a wire or an inductor can be far greater than the d-c value when the coil is used in a radio-frequency circuit; this is because the current does not travel through the entire cross-section of the conductor, but has a tendency to travel closer and closer to the surface of the wire as the frequency is increased. This is known as the *skin effect*.

The actual current-carrying portion of the wire is decreased,

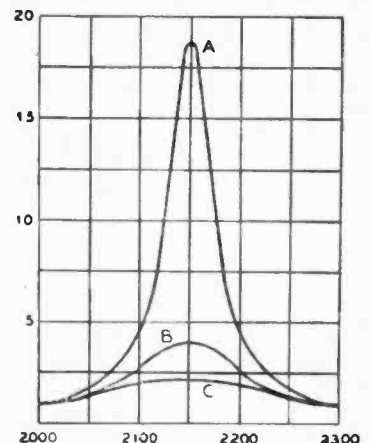

Figure 29.
RESONANCE CURVE.
Resonance curve showing the effect of resistance upon the selectivity of a tuned circuit. Curve "A" is for the smallest amount of resistance (greatest Q) and curve "C" is for a large amount of resistance (low Q).

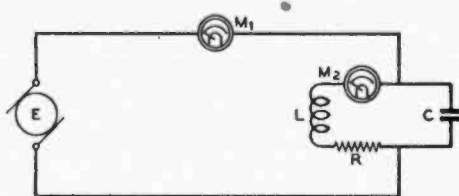

Figure 30.

PARALLEL-RESONANT CIRCUIT.

The inductance L and capacitance C comprise the reactive elements of the parallel-resonant (anti-resonant) tank circuit, and the resistance R indicates the sum of the r - f resistance of the coil and capacitor plus the resistance coupled into the circuit by the load. In most cases the tuning capacitor has much lower r - f resistance than the coil and can therefore be ignored in comparison with the coil resistance and coupled-in resistance. The instrument M_1 indicates the "line current" which keeps the circuit in a state of oscillation. The instrument M_2 indicates the "tank current" which is equal to the line current multiplied by the Q of the circuit.

therefore, and the resistance is increased. This effect becomes even more pronounced in square or rectangular conductors because the principal path of current flow tends to work outwardly toward the four edges of the wire.

Examination of the equation for Q may give rise to the thought that even though the resistance becomes greater with frequency, the inductive reactance does likewise, and that the Q might be a constant. In actual practice, however, this is true only at very low frequencies; the resistance usually increases more rapidly with frequency than does the reactance, with the result that Q normally decreases slowly with increasing frequency.

The Q of a capacitor ordinarily is much higher than that of the best coil. Therefore, it usually is the merit of the coil that limits the overall Q of the circuit.

At audio frequencies the core losses in an iron-core inductor greatly reduce the Q from the value that would be obtained simply by dividing the reactance by the resistance. Obviously the core losses also represent circuit resistance, just as much so as though the loss occurred in the wire itself.

Parallel Resonance In radio circuits, parallel resonance (more correctly termed *antiresonance*) is more frequently encountered than series resonance; in fact, it is the basic foundation of receiver and transmitter circuit operation. A circuit is shown in Figure 30.

The "Tank" Circuit In this circuit, as contrasted with a circuit for series resonance, L (inductance) and C (capacitance) are connected in *parallel*, yet the combination can be considered to be in series with the remainder of the circuit. This combination of L and C , in conjunction with R , the resistance which is principally included in L , is sometimes called a *tank* circuit because it effectively functions as a storage tank when incorporated in vacuum tube circuits.

Contrasted with series resonance, there are two kinds of current which must be considered in a parallel resonant circuit: (1) the line current, as read on the indicating meter M_1 , (2) the circulating current which flows within the parallel L - C - R portion of the circuit. See Figure 30.

At the resonant frequency, the line current (as read on the meter M_1) will drop to a very low value, although the circulating current in the L - C circuit may be quite large. It is interesting to note that the parallel resonant circuit acts in a distinctly opposite manner to that of a series resonant circuit, in which the current is at a maximum and the impedance is minimum at resonance. It is for this reason that in a parallel

resonant circuit the principal consideration is one of impedance rather than current. It is also significant that the *impedance* curve for *parallel* circuits is very nearly identical to that of the *current* curve for *series* resonance. The impedance at resonance is expressed as:

$$Z = \frac{(2\pi fL)^2}{R}$$

where Z = impedance in ohms,
 L = inductance in henrys,
 f = frequency in cycles,
 R = resistance in ohms.

Or, impedance can be expressed as a function of Q as:

$$Z = 2\pi fLQ$$

showing that the impedance of a circuit is directly proportional to its effective Q at resonance.

The curves illustrated in Figure 29 can be applied to parallel resonance. Reference to the curve will show that the effect of adding resistance to the circuit will result in both a broadening out and a lowering of the peak of the curve. Since the voltage of the circuit is directly proportional to the impedance, and since it is this voltage that is applied to the grid of the vacuum tube in a detector or amplifier circuit, the impedance curve must have a sharp peak in order for the circuit to be *selective*. If the curve is broad-topped in shape, both the desired signal and the interfering signals at close proximity to resonance will give nearly equal voltages on the grid of the tube, and the circuit will then be *non-selective*; i.e., it will tune broadly.

Effect of L/C Ratio in Parallel Circuits In order that the highest possible voltage can be developed across a parallel resonant circuit, the impedance of this circuit must be very high. The impedance will be greater with conventional coils of limited Q when the ratio of inductance-to-capacitance is great, that is, when L is large as compared with C . When the resistance of the circuit is very low, X_L will equal X_C at maximum impedance. There are innumerable ratios of L and C that will have *equal* reactance, at a given resonant frequency, exactly as is the case in a series resonant circuit.

In practice, where a certain value of inductance is tuned by a variable capacitance over a fairly wide range in frequency, the L/C ratio will be small at the lowest frequency and large at the high-frequency end. The circuit, therefore, will have unequal gain and selectivity at the two ends of the band of frequencies which is being tuned. Increasing the Q of the circuit (lowering the resistance) will obviously increase *both* the selectivity and gain.

Circulating Tank Current at Resonance The Q of a circuit has a definite bearing on the circulating tank current at resonance. This tank current is very nearly the value of the line current multiplied by the effective circuit Q . For example: an r - f line current of 0.050 amperes, with a circuit Q of 100, will give a circulating tank current of approximately 5 amperes. From this it can be seen that both the inductor and the connecting wires in a circuit with a high Q must be of very low resistance, particularly in the case of high power transmitters, if heat losses are to be held to a minimum.

Because the voltage across the tank at resonance is determined by the Q , it is possible to develop very high-peak voltages across a high Q tank with but little line current.

Effect of Coupling on Impedance If a parallel resonant circuit is coupled to another circuit, such as an antenna output circuit, the impedance and the effective Q of the parallel circuit is decreased as the coupling

becomes closer. The effect of closer (tighter) coupling is the same as though an actual resistance were added in series with the parallel tank circuit. The resistance thus coupled into the tank circuit can be considered as being *reflected* from the output or load circuit to the driver circuit.

Tank Circuit When the plate circuit of a Class B or Class C operated tube (defined in Chapter 4) is connected to a parallel resonant circuit tuned to the same frequency as the exciting voltage for the amplifier, the plate current serves to maintain this L/C circuit in a state of oscillation.

The plate current is supplied in short pulses which do not begin to resemble a sine wave, even though the grid may be excited by a sine-wave voltage. These spurts of plate current are converted into a sine wave in the plate tank circuit by virtue of the "Q" or "flywheel effect" of the tank.

If a tank did not have some resistance losses, it would, when given a "kick" with a single pulse, continue to oscillate indefinitely. With a moderate amount of resistance or "friction" in the circuit the tank will still have inertia, and continue to oscillate with decreasing amplitude for a time after being given a "kick." With such a circuit, almost pure sine-wave voltage will be developed across the tank circuit even though power is supplied to the tank in short pulses or spurts, so long as the spurts are evenly spaced with respect to time and have a frequency that is the same as the resonant frequency of the tank.

Another way to visualize the action of the tank is to recall that a resonant tank with moderate Q will discriminate strongly against harmonics of the resonant frequency. The distorted plate current pulse in a Class C amplifier contains not only the fundamental frequency (that of the grid excitation voltage) but also higher harmonics. As the tank offers low impedance to the harmonics and high impedance to the fundamental (being resonant to the latter), only the fundamental—a sine-wave voltage—appears across the tank circuit in substantial magnitude.

The operation of tuned tank circuits in conjunction with radio-frequency power amplifiers is discussed further in Chapter 4, Section 4-12, and in Chapter 6.

2-8 Transformers

When two coils are placed in such inductive relation to each other that the lines of force from one cut across the turns of the other and induce a voltage in so doing, the combination can be called a *transformer*. The name is derived from the fact that energy is transformed from one voltage into another. The inductance in which the original flux is produced is called the *primary*; the inductance which *receives* the induced voltage is called the *secondary*. In a radio receiver power transformer, for example, the coil through which the 110-volt a.c. passes is the *primary*, and the coil from which a higher or lower voltage than the a-c line potential is obtained is the *secondary*.

Transformers can have either air or magnetic cores, depending upon whether they are to be operated at radio or audio frequencies. The reader should thoroughly impress upon his mind the fact that current can be transferred from one circuit to another *only* if the primary current is changing or alternating. From this it can be seen that a power transformer cannot possibly function as such when the primary is supplied with non-pulsating d.c.

A power transformer usually has a magnetic core which consists of laminations of iron, built up into a square or rectangular form, with a center opening or window. The secondary windings may be several in number, each perhaps delivering a different voltage. The secondary voltages will be proportional to the number of turns and to the primary voltage.

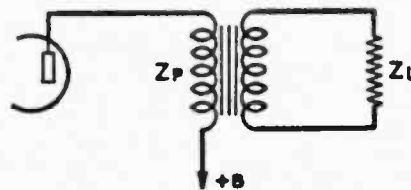

Figure 31.

The reflected impedance Z_r varies directly in proportion to Z_L and in proportion to the square of the primary-to-secondary turns ratio.

Types of Transformers Transformers are used in alternating-current circuits to transfer power at one voltage and impedance to another circuit at another voltage and impedance. There are three main classifications of transformers: those made for use in power-frequency circuits, those made for audio-frequency applications, and those made for radio frequencies. Power-frequency transformers are discussed in Chapter 25, *Power Supplies*; design and application data on power transformers is given in this chapter. The application of audio-frequency transformers is given in Chapter 4, particularly in the section devoted to *Audio Frequency Power Amplifiers*. Radio frequency transformers are also discussed in Chapter 4 in the section devoted to *Tuned R-F Voltage Amplifiers*.

The Auto Transformer The type of transformer in Figure 32, when wound with heavy wire over an iron core, is a common device in primary power circuits for the purpose of increasing or decreasing the line voltage. In effect, it is merely a continuous winding with taps taken at various points along the winding, the input voltage being applied to the bottom and also to one tap on the winding. If the output is taken from this same tap, the voltage ratio will be 1-to-1; i.e., the input voltage will be the same as the output voltage. On the other hand, if the output tap is moved down toward the common terminal, there will be a step-down in the turns ratio with a consequent step-down in voltage.

The opposite holds true if the output terminal is moved upward from the middle input terminal; there will be a voltage step-up in this case. The initial setting of the middle input tap is chosen so that the number of turns will have sufficient reactance to keep the no-load primary current at a reasonably low value.

2-9 Electric Filters

There are many applications where it is desirable to pass a d-c component without passing a superimposed a-c component, or to pass all frequencies above or below a certain frequency while rejecting or attenuating all others, or to pass only a certain band or bands of frequencies while attenuating all others.

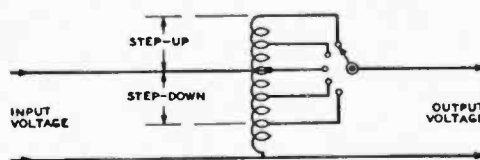

Figure 32.

THE AUTOTRANSFORMER.

Schematic diagram of an autotransformer showing the method of connecting it to the line and to the load. When only a small amount of step up or step down is to be employed, the autotransformer may be much smaller physically than would be a transformer with isolated primary and secondary.

All of these things can be done by suitable combinations of inductance, capacitance, and resistance. However, as whole books have been devoted to nothing but electric filters, it can be appreciated that it is possible only to touch upon them superficially in a book which covers general radio theory in a single chapter.

A filter acts by virtue of its property of offering very high impedance to the undesired frequencies, while offering but little impedance to the desired frequencies. This will also apply to d.c. with a superimposed a-c component, as d.c. can be considered as an alternating current of zero frequency so far as filter discussion goes.

Sometimes a shunt or series element of an L-C filter is resonated with a reactance of opposite sign. When this is done, the section is known as an *M-derived* section. If the complementary reactance is added to a series arm, the section is said to be *shunt derived*: if added to the shunt arm, *series derived*.

A derived filter has sharper cut off than a regular constant K filter, but has less attenuation than the constant K section at frequencies far removed from cut off. The effect of resonating the series inductance of a π section filter to form an M-derived filter is shown in Figure 33. The "notch" frequency is determined by the resonant frequency of the filter element which is tuned. The closer the resonant frequency is made to cut off, the sharper will be the cut off attenuation, but the less will be the attenuation at several times the cut off frequency.

The amount of attenuation obtained at the "notch" when a derived section is used is determined by the effective Q of the resonant arm.

Oftentimes a constant-K section and a derived section are cascaded to obtain the combined characteristic of sharp cut off and good remote-frequency attenuation. Such a filter is known as a *composite* filter.

All filters have some *insertion loss*. This is the attenuation (substantially uniform) provided to frequencies within the pass band. The insertion loss varies with the kind of filter, the Q of capacitors and inductors used, and the type termination employed.

Electric Filter Design Electric wave filters have long been used in some amateur stations in the audio channel

to reduce the transmission of unwanted high frequencies and hence to reduce the bandwidth occupied by a radiophone signal. Of late the use of electric filters has become more general in clipper-filter or "clipper" circuits as described in Chapter 7 and illustrated in Chapter 24. The effectiveness of a properly designed and properly used filter circuit in reducing QRM and sideband splatter should not be underestimated.

The chart of Figure 33 gives design data and procedure on the pi-section type of filter most commonly used in clipper-filter circuits. If a single section of filter is to be used, it should preferably be of the M-derived type with an M of 0.6, as set forth in Figure 33. If more than one section of filter is to be used, and an additional section or two will contribute to the reduction in broadness of the signal, a combination of an M-derived input section followed by a constant-K section is probably the next better arrangement. The next best after this type in effectiveness will probably be found to be an M-derived section in the center with a terminating half-section on the input and output of the filter.

M-derived sections with an M of 0.6 will be found to be most satisfactory as the input impedance of such a section is most constant over the pass band of the filter section.

Simple filters may use either L, T, or π sections. Since the π section is the more commonly used type Figure 33 gives design data and characteristics for this type of filter.

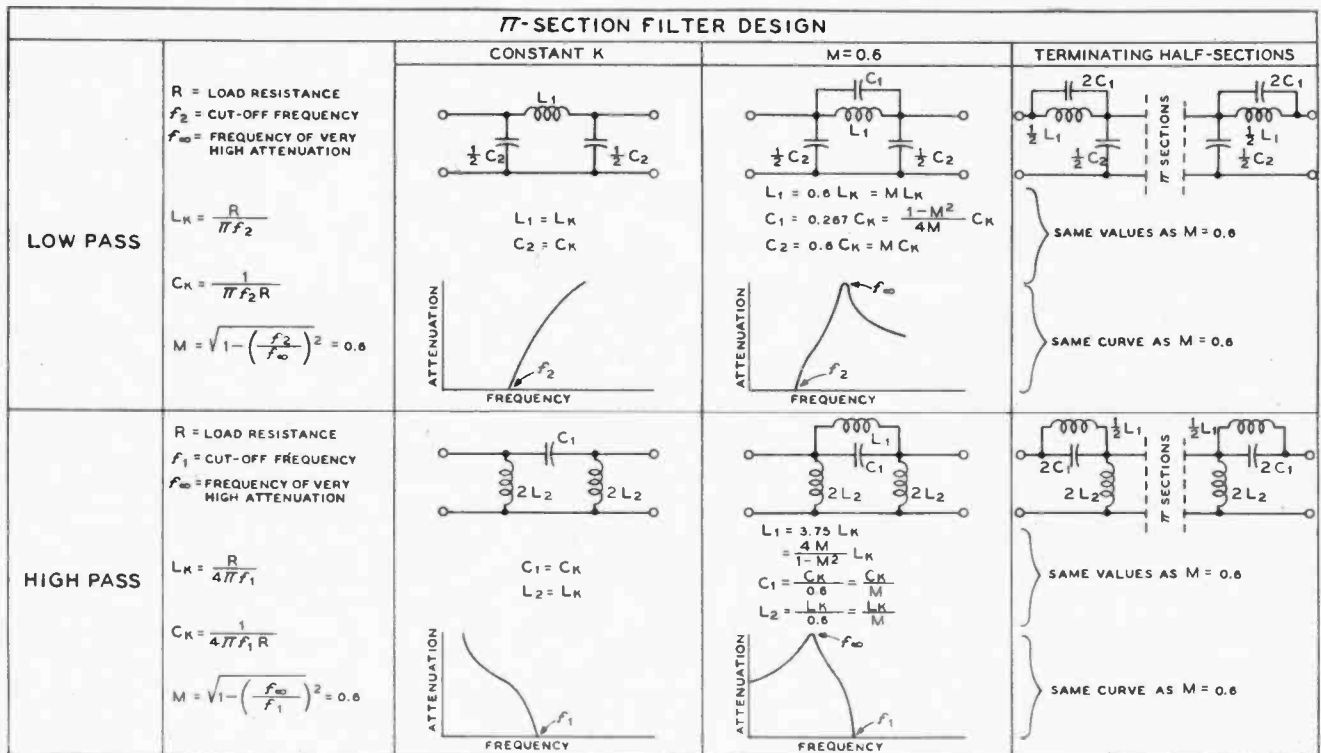

Figure 33.

Through the use of the curves and equations in the accompanying illustration it is possible to determine the correct values of inductance and capacitance for the most practical types of pi-filter sections.

Vacuum Tube Principles

THE BASIS of development of the vacuum tube was the discovery in the 1890's by Thomas Edison of the fact that a heated filament would give off electrons to a cold plate situated in the same evacuated chamber. It was later discovered that if the plate were charged positively with respect to the filament a much larger proportion of the electrons emitted by the filament would be attracted to the plate. Further, it was determined that if the plate were charged negatively with respect to filament the electron flow to the plate would cease. This valve action meant that the electron tube could be used as a rectifier since it would pass current in only one direction. It is this valve or rectifying action of the two-element vacuum tube or diode which is used for the production of unidirectional or direct current from the alternating current supplied from the a-c mains.

Thermionic Emission The free electrons in any metal are continually in motion at all temperatures. But at ordinary atmospheric temperatures, these electrons do not have sufficient energy to penetrate the surface of the material. It is necessary that some form of external energy be supplied to the surface for emission to take place. When this energy supply is in the form of heat, the result is called thermionic emission; when the energy is in the form of light it is called photo-emission. The phenomena of photo-emission is applied in the photo-electric tube, while thermionic emission supplies the electrons for the operation of the vacuum tube.

In order that thermionic emission may take place, it is necessary that the cathode or filament of the vacuum tube be heated to the point where the free electrons in the emitter have sufficient velocity to penetrate the surface. The degree of temperature to which the emitter must be heated varies greatly with the type of emitter. Since there are several types of emitters commonly found in present day transmitting and receiving tubes, these will be described separately.

3-1 Cathodes

The emitters or cathodes as used in present-day vacuum tubes may be classified into two groups: the directly-heated or filament type and the indirectly-heated or heater-cathode type. Directly-heated emitters may be further subdivided into three important groups, all of which are commonly used in modern

vacuum tubes. These classifications are: the pure-tungsten filament, the thoriated-tungsten filament, and the oxide-coated filament.

The Pure Tungsten Filament Pure tungsten wire was used as the filament in nearly all the earlier transmitting and receiving tubes. However, the thermionic efficiency of tungsten wire as an emitter (the number of milliamperes emission per watt of filament heating power) is quite low, the filaments become fragile after use, their life is rather short, and they are susceptible to burnout at any time. Pure tungsten filaments must be run at bright white heat (about 2500° Kelvin). For these reasons, tungsten filaments have been replaced in all applications where another type of filament could be used. They are, however, still universally employed in most water-cooled tubes and in certain large, high-power air-cooled triodes where another filament type would be unsuitable. Tungsten filaments are the most satisfactory for high-power, high-voltage tubes where the emitter is subjected to positive ion bombardment due to the residual gas content of the tubes. Tungsten is not adversely affected by such bombardment.

The Thoriated-Tungsten Filament In the course of experiments made upon tungsten emitters, it was found that filaments made from tungsten having a small amount of thoria (thorium oxide) as an impurity had much greater emission than those made from the pure metal. Subsequent development has resulted in the highly efficient carburized thoriated-tungsten filament as used in virtually all medium-power transmitting tubes today.

Thoriated-tungsten emitters consist of a tungsten wire containing from 1% to 2% thoria. The activation process varies between different manufacturers of vacuum tubes, but it is essentially as follows: (1) the tube is outgassed; (2) the filament is burned for a short period at about 2800° Kelvin to clean the surface and reduce some of the thoria within the filament to metallic thorium; (3) the filament is burned for a longer period at about 2100° Kelvin to form a layer of thorium on the surface of the tungsten; (4) the temperature is reduced to about 1600° Kelvin and some pure hydrocarbon gas is admitted to form a layer of tungsten carbide on the surface of

the tungsten. This layer of tungsten carbide reduces the rate of tungsten evaporation from the surface at the normal operating temperature of the filament and thus increases the operating life of the vacuum tube. Thorium evaporation from the surface is a natural consequence of the operation of the thoriated-tungsten filament. The carburized layer on the tungsten wire plays another role in acting as a reducing agent to produce new thorium from the thoria to replace that lost by evaporation. This new thorium continually diffuses to the surface during the normal operation of the filament. The last process, (5), in the activation of a thoriated tungsten filament consists of re-evacuating the envelope and then burning or ageing the new filament for a considerable period of time at the normal operating temperature of approximately 1900° Kelvin.

One thing to remember about any type of filament, particularly the thoriated type, is that the emitter deteriorates practically as fast when "standing by" (no plate current) as it does with any normal amount of emission load. Also, a thoriated filament may be either temporarily or permanently damaged by a heavy overload which may strip the surface layer of thorium from the filament.

Reactivating Thoriated-Tungsten Filaments

Thoriated-tungsten filaments (and *only* thoriated-tungsten filaments) which have gone "flat" as a result of insufficient filament voltage, a severe temporary overload, a less severe extended overload, or even normal operation may quite frequently be reactivated to their original characteristics by a process similar to that of the original activation. However, only filaments which have not approached too close to the end of their useful life may be successfully reactivated. The filament found in certain makes of tubes may be reactivated three or four times before it will cease to operate as a thoriated emitter.

The actual process of reactivation is simple enough and only requires a filament transformer with taps allowing voltage up to about 25 volts or so. The tube which has gone flat is placed in a socket to which only the two filament wires have been connected. The filament is then "flashed" for about 20 to 40 seconds at about 1½ times normal rated voltage. The filament will become extremely bright during this time and, if there is still some thoria left in the tungsten and if the tube didn't originally fail as a result of an air leak, some of this thoria will be reduced to metallic thorium. The filament is then burned at 15 to 25 per cent overvoltage for from 30 minutes to 3 to 4 hours to bring this new thorium to the surface.

The tube should then be tested to see if it shows signs of renewed life. If it does, but is still weak, the burning process should be continued at about 10 to 15 per cent overvoltage for a few more hours. This should bring it back almost to normal. If the tube checks still very low after the first attempt at reactivation, the complete process can be repeated as a last effort.

As has been mentioned above, thoriated-tungsten filaments are operated at about 1900° K or at a bright yellow heat. A burnout at normal filament voltage is almost an unheard of occurrence. The ratings placed upon tubes by the manufacturers are figured for a life expectancy of 1000 hours. Certain types may give much longer life than this but the average transmitting tube will give from 1000 to 5000 hours of useful life.

The most efficient of all modern filaments is the oxide-coated type which consists of a mixture of barium and strontium oxides coated upon a wire or strip usually of a nickel alloy. This type of filament operates at a dull-red to orange-red temperature

The Oxide-Coated Filament

(1050° to 1170° K) at which temperature it will emit large quantities of electrons. The oxide-coated filament is somewhat more efficient than the thoriated-tungsten type in small sizes and it is considerably less expensive to manufacture. For this reason all receiving tubes and quite a number of the low-powered transmitting tubes use the oxide-coated filament. Another advantage of the oxide-coated emitter is its extremely long life—the average tube can be expected to run from 3000 to 5000 hours, and when loaded very lightly, tubes of this type have been known to give 50,000 hours of life before their characteristics changed to any great extent.

The oxide-coated filament does have the disadvantage, however, that it is unsuitable for use in tubes which must withstand more than about 750 volts of direct plate potential. Oxide filaments are unsatisfactory for use at high continuous plate voltages because: (1) their activity is seriously impaired by the high temperature necessary to de-gas the high-voltage tubes and, (2) the positive ion bombardment which takes place even in the best evacuated high-voltage tube causes destruction of the oxide layer on the surface of the filament.

The activation of oxide-coated filaments also varies with tube manufacturers but consists essentially in heating the wire which has been coated with a mixture of barium and strontium carbonates to a temperature of about 1500° Kelvin for a time and then applying a potential of 100 to 200 volts through a protective resistor to limit the emission current. This process reduces the carbonates to oxides thermally, cleans the filament surface of foreign materials, and apparently produces small amounts of metallic barium and strontium on the surface.

Reactivation of oxide-coated filaments is not possible since there is always more than sufficient reduction of the oxides and diffusion of the metals to the surface of the filament to meet the emission needs of the cathode.

The heater type cathode was developed as a result of the requirement for a type of emitter which could be operated from alternating current and yet would not introduce a-c ripple modulation even when used in low-level stages. It consists essentially of a small nickel-alloy cylinder with a coating of strontium and barium oxides on its surface similar to that used on the oxide-coated filament. Inside the cylinder is an insulated heater element consisting usually of a double spiral of tungsten wire. The heater may operate on any voltage from 2 to 117 volts, although 6.3 is by far the most common value. The heater is operated at quite a high temperature so that the cathode itself may be brought to operating temperature in a matter of 15 to 30 seconds. Heat coupling between the heater and the cathode is mainly by radiation, although there is some thermal conduction through the insulating coating on the heater wire, as this coating is also in contact with the cathode thimble.

Indirectly heated cathodes are employed in all a-c operated tubes which are designed to operate at a low level either for r-f or a-f use. However, some receiver power tubes use heater cathodes (6L6, 6V6, 6F6, and 6K6-GT) as do some of the low-power transmitter tubes (802, 807, 815, 3E29, T21, and RK39). Heater cathodes are employed almost exclusively when a number of tubes are to be operated in series as in an a-c-d-c receiver. A heater cathode is often called a uni-potential cathode because there is no voltage drop along its length as there is in the directly-heated or filament cathode.

The Heater Cathode

The heater type cathode was developed as a result of the requirement for a type of emitter which could be operated from alternating current and yet would not introduce a-c ripple modulation even when used in low-level stages. It consists essentially of a small nickel-alloy cylinder with a coating of strontium and barium oxides on its surface similar to that used on the oxide-coated filament. Inside the cylinder is an insulated heater element consisting usually of a double spiral of tungsten wire. The heater may operate on any voltage from 2 to 117 volts, although 6.3 is by far the most common value. The heater is operated at quite a high temperature so that the cathode itself may be brought to operating temperature in a matter of 15 to 30 seconds. Heat coupling between the heater and the cathode is mainly by radiation, although there is some thermal conduction through the insulating coating on the heater wire, as this coating is also in contact with the cathode thimble.

Indirectly heated cathodes are employed in all a-c operated tubes which are designed to operate at a low level either for r-f or a-f use. However, some receiver power tubes use heater cathodes (6L6, 6V6, 6F6, and 6K6-GT) as do some of the low-power transmitter tubes (802, 807, 815, 3E29, T21, and RK39). Heater cathodes are employed almost exclusively when a number of tubes are to be operated in series as in an a-c-d-c receiver. A heater cathode is often called a uni-potential cathode because there is no voltage drop along its length as there is in the directly-heated or filament cathode.

3-2 Other Electrodes

The cathode, discussed in the previous section, is the source of electrons in the electron tube or vacuum tube. The element whose function it is to collect the electrons emitted by the cathode is commonly called the *plate*, after Edison's original nomenclature, although the term *anode* is equally correct. In

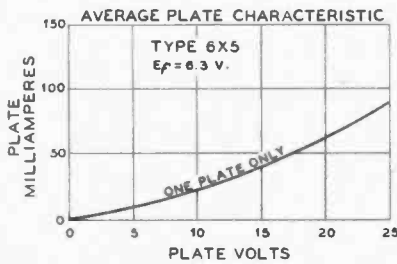

Figure 1.

PLATE CHARACTERISTICS FOR A DIODE.

Curve showing the number of electrons reaching the plate (plate current) plotted as a function of plate voltage. There is a small flow of plate current even at zero plate voltage. As the plate voltage is increased in a positive direction the plate current increases approximately as the 3/2 power of the plate voltage.

addition to the cathode and plate (source and collector of electrons) which comprise the elements of the *diode*, one or more control electrodes may be placed between the cathode and plate. These control electrodes are commonly called *grids* since they frequently resemble mechanically a gridiron or grid. A vacuum tube with cathode, one grid, and plate is called a *triode*; one having cathode, two grids, and plate is called a *tetrode*; if it has three grids in addition to cathode and plate it is called a *pentode*; with four grids, a *hexode*; with five grids, a *heptode*, although one class of vacuum tube having cathode, five grids, and plate is called a *pentagrid converter*.

Anode Materials In receiving tubes where the plate is not required to dissipate any appreciable amount of power the anode material is usually nickel or pure iron. Where the plate of the tube is required to dissipate a moderate amount of power the nickel or iron plate is frequently coated with carbon so that the anode structure will operate at a lower temperature for a given amount of energy dissipation. Small transmitting tubes such as the 807, 815, and 3E29 which employ oxide-coated cathodes also use carbonized nickel or iron as the anode material.

Medium-power transmitting tubes of the types commonly employed by radio amateurs utilize a variety of anode materials. One of the most common anode materials in tubes designed to operate at anode potentials from perhaps 750 to 2500 volts is graphite. This material has the greatest emissivity for a given temperature of any common anode material. Where high-voltage operation (2500 to 7500 volts) is desired the anode material is usually either pure tantalum, pure molybdenum, or zirconium-coated molybdenum. The latter anode material is becoming increasingly popular with vacuum-tube manufacturers for transmitting tubes of all power capabilities due to its excellent characteristics both with regard to heat radiation and "gettering" or de-gassing action during the life of the tube. Zirconium-coated carbon is also employed in certain lower voltage transmitting tubes.

3-3 Types of Vacuum Tubes

There are a large number of different types of vacuum tubes employed in the field of electronics. A brief description of the more common types and their characteristics will be given in the following paragraphs. The practical application of the types of most interest to the radio amateur will be discussed in the chapters to follow.

The Diode If a cathode capable of being heated either indirectly or directly is placed in an evacuated envelope along with a plate, such a two-element vacuum tube is called a diode. The diode is the simplest of all vacuum tubes

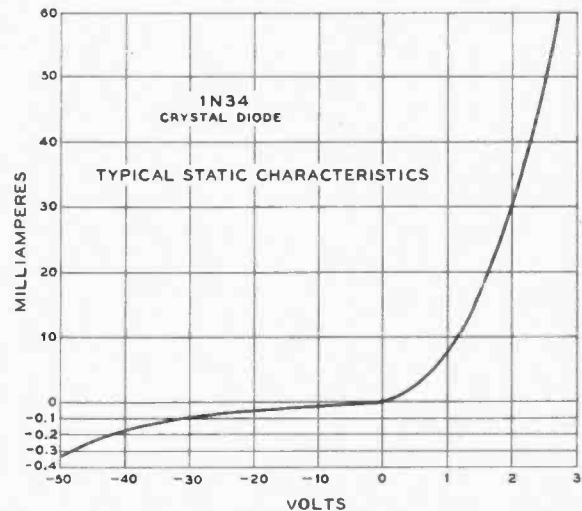

Figure 2.

CHARACTERISTICS FOR A CRYSTAL DIODE.

Note that the crystal diode conducts several thousand times more readily in one direction than in the other.

and is the fundamental type from which all the others are derived; hence, the diode and its characteristics will be discussed first.

Characteristics of the Diode When the cathode within a diode is heated, it will be found that a few of the electrons leaving the cathode will leave with sufficient velocity to reach the plate. If the plate is electrically connected back to the cathode, the electrons which have had sufficient velocity to arrive at the plate will flow back to the cathode through the external circuit. This small amount of initial plate current is an effect found in all two-element vacuum tubes.

If a battery or other source of d-c voltage is placed in the external circuit between the plate and cathode so that it places a positive potential on the plate, the flow of current from the cathode to plate will be increased. This is due to the strong attraction offered by the positively charged plate for any negatively charged particles. If the positive potential on the plate is increased, the flow of electrons between the cathode and plate will also increase up to the point of *saturation*. Saturation current flows when all of the electrons leaving the cathode are attracted to the plate, and no increase in plate voltage can increase the number of electrons being attracted.

The Space Charge Effect As a cathode is heated so that it begins to emit, those electrons which have been discharged into the surrounding space form in the immediate vicinity of the cathode a negative charge which acts to repel those electrons which normally would be emitted were the charge not present. This cloud of electrons around the cathode is called the *space charge*. The electrons comprising the charge are continuously changing, since those electrons making up the original charge fall back into the cathode and are replaced by others emitted by it.

The effect of the space charge is to make the current through the tube variable with respect to the plate-to-cathode drop across it. As the plate voltage is increased, the positive charge of the plate tends to neutralize the negative space charge in the vicinity of the cathode. This neutralizing action upon the space charge by the increased plate voltage allows a greater number of electrons to be emitted from the cathode which, obviously, causes a greater plate current to flow. When the point is reached at which the space charge around the cathode is neutralized completely, all the electrons that the cathode is

capable of emitting are being attracted to the plate and the tube is said to have reached *saturation* plate current as mentioned above.

Barrier-Layer Diodes The characteristic of unidirectional electron flow between the two elements of the diode can be attained through the use of the so-called *barrier layer effect* as well as through the use of the two-element vacuum tube. Two common electronic components which utilize this effect are the *dry-disc rectifier* and the *rectifying crystal*. Two common types of dry-disc rectifier are the *copper-oxide* rectifier and the *selenium* rectifier. Dry-disc rectifiers are frequently employed in power supplies where power-line frequency alternating current must be converted into d.c. at moderate voltage (6 to 30 volts) and at currents from a few hundred milliamperes to 10 or 20 amperes. The selenium rectifier is attaining considerable acceptance in this field and in addition selenium rectifiers are enjoying some application in power supplies where moderate currents at from 1000 to 5000 volts are required.

Rectifying-crystal diodes are most frequently employed in the rectification of r-f energy. The predecessor of these modern units is the galena or silicon crystal used in the "wireless" days of radio. Crystal diodes are available at this time in two general types. The first type was developed for use as a mixer in s-h-f radar receivers and utilizes a small piece of silicon crystal sealed in a ceramic holder with a "cat whisker" factory adjusted to the proper spot on the crystal. This type is suitable for rectifying only a very small amount of energy, although types are available for use up to 30,000 megacycles. The 1N21B is a commonly available crystal of this general type. The second type, which uses a germanium crystal element, has more recently been developed for use at higher energy levels and at frequencies up to about 100 megacycles. This type, exemplified by the 1N34 and 1N35, has found wide application as a second detector or demodulator in high-frequency FM and AM receivers. This type is also especially well suited to use as the rectifying element in field-strength meters and modulation monitors.

The Triode If an element consisting of a mesh or spiral of wire is inserted concentric with the plate and between the plate and the cathode, such an element will be able to control by electrostatic action the cathode-to-plate current of the tube. The new element is called a grid, and a

vacuum tube containing a cathode, grid, and plate is commonly called a triode.

If this new element through which the electrons must pass in their course from cathode to plate is made negative with respect to the cathode, the negative charge on this grid will effectively repel the negatively charged electrons (like charges repel; unlike charges attract) back into the space charge surrounding the cathode. Hence, the number of electrons which are able to pass through the grid mesh and reach the plate will be reduced, and the plate current will be reduced accordingly. As a matter of fact, if the charge on the grid is made sufficiently negative, all the electrons leaving the cathode will be repelled back to it and the plate current will be reduced to zero. Any d-c voltage placed upon a grid is called a *bias* (especially so when speaking of a control grid). The smallest negative voltage which will cause cutoff of plate current at a particular plate voltage is called the value of *cutoff bias*.

Figure 3 illustrates an analogy of the method in which the number of electrons flowing to the plate is controlled by the grid bias. Figure 4 graphically shows essentially the same information as shown in Figure 3; i.e., the manner in which the plate current of a typical triode will vary with different values of grid bias. Figure 4 also shows graphically the cut-off point, the approximately linear relation between grid bias and plate current over the operating range of the tube, and the point of plate current saturation. However, the point of plate current saturation comes at a different position with a triode as compared to a diode. Plate current non-linearity or saturation may begin either at the point where the full emission capabilities of the filament have been reached, or at the point where the positive grid voltage approaches the positive plate voltage.

This latter point is commonly referred to as the *diode bend* and is caused by the positive voltage of the grid allowing it to rob from the current stream electrons that would normally go to the plate. When the plate voltage is low with respect to that required for full current from the cathode, the diode bend is reached before plate current saturation. When the plate voltage is high, saturation is reached first.

From the above it can be seen that the grid acts as a valve

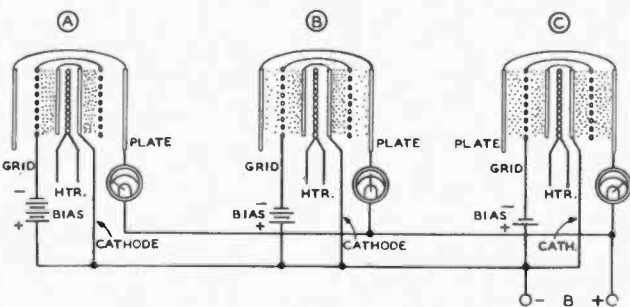

Figure 3.

ACTION OF THE GRID IN A TRIODE.

(A) shows the triode tube with cutoff bias on the grid. Note that all the electrons emitted by the cathode remain inside the grid mesh. (B) shows the same tube with an intermediate value of bias on the grid. Note the medium value of plate current and the fact that there is a reserve of electrons remaining within the grid mesh. (C) shows the operation with a relatively small amount of bias which with certain tube types will allow substantially all the electrons emitted by the cathode to reach the plate. Emission is said to be saturated in this case. In a majority of tube types a high value of positive grid voltage is required before plate-current saturation takes place.

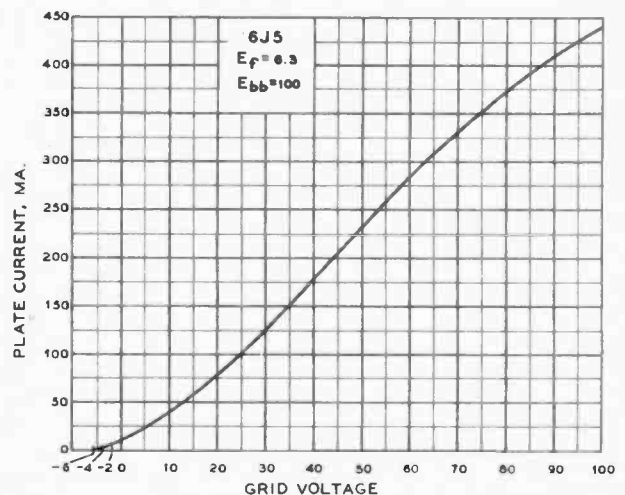

Figure 4.

TRIODE PLATE CHARACTERISTICS.

This curve shows plate current plotted against grid bias for a constant value of plate voltage on a standard triode tube type. Note the relatively tremendous emission capability of the oxide-coated heater cathode used in tubes of the general type of the 6J5. Only a very small amount of this peak emission capability is used in a normal triode voltage amplifier stage. However, when such a tube is used as a pulse amplifier or generator substantially all the peak emission capability may be used.

in controlling the electron flow from the cathode to the plate. As long as the grid is kept negative with respect to the cathode, only an extremely small amount of grid energy is required to control a comparatively large amount of plate power. Even if the grid is operated in the positive region a portion of the time, so that it will draw current, the grid energy requirements are still very much less than the energy controlled in the plate circuit. It is for this reason that a vacuum tube is commonly called a valve in British countries.

Tetrode or Screen-Grid Tube In the preceding chapter it was mentioned that two conductors separated by a dielectric form a capacitor, or that there is capacitance between them. Since the electrodes in a vacuum tube are conductors and they are separated by a dielectric, vacuum, there is capacitance between them. Although the inter-electrode capacitances are so small as to be of little consequence in audio-frequency work, they are large enough to be of considerable importance when triodes are operated at radio frequencies.

The quest for a simple and easily usable method of eliminating the effects of the grid-to-plate capacitance of the triode led to the development of the *screen-grid* tube or *tetrode*. When another grid is added between the grid and plate of a vacuum tube the tube is called a tetrode, and because the new grid is called a *screen*, as a result of its screening or shielding action, the tube is often called a screen-grid tube. The interposed screen grid acts as an electrostatic shield between the grid and plate, with the consequence that the grid-to-plate capacitance is reduced. Although the screen grid is maintained at a positive voltage with respect to the cathode of the tube, it is maintained at ground potential with respect to r.f. by means of a by-pass capacitor of very low reactance at the frequency of operation.

In addition to the shielding effect, the screen grid serves another very useful purpose. Since the screen is maintained at a positive potential, it serves to increase or accelerate the flow of electrons to the plate. There being large openings in the screen mesh, most of the electrons pass through it and on to the plate. Due also to the screen, the plate current is largely independent of plate voltage, thus making for high amplification. When the screen voltage is held at a constant value, it is possible to make large changes in plate voltage without appreciably affecting the plate current.

When the electrons from the cathode approach the plate with sufficient velocity, they dislodge electrons upon striking the plate. This effect of *bombarding* the plate with high velocity electrons, with the consequent dislodgement of other electrons from the plate, is known as *secondary emission*. This effect can cause no particular difficulty in a triode because the secondary electrons so emitted are eventually attracted back to the plate. In the screen-grid tube, however, the screen is close to the plate and is maintained at a positive potential. Thus, the screen will attract these electrons which have been knocked from the plate, particularly when the plate voltage falls to a lower value than the screen voltage, with the result that the plate current is lowered and the amplification is decreased.

The Pentode The undesirable effects of secondary emission from the plate can be greatly reduced if another element is added between the screen and plate. This additional element is called a *suppressor*, and tubes in which it is used are called *pentodes*. The suppressor grid is sometimes connected to cathode within the tube, sometimes it is brought out to a connecting pin on the tube base, but in any case it is established negative with respect to the minimum plate voltage. The secondary electrons that would travel to the screen if there were no suppressor are diverted back to the plate. The

plate current is, therefore, not reduced and the amplification possibilities are increased.

Pentodes for audio applications are designed so that the suppressor increases the limits to which the plate voltage may swing; therefore the consequent power output and gain can be very great. Pentodes for radio-frequency service function in such a manner that the suppressor allows high voltage gain, at the same time permitting fairly high gain at low plate voltage. This holds true even if the plate voltage is the same or slightly lower than the screen voltage.

Beam Power Tubes A beam power tube makes use of another method for suppressing secondary emission. In this tube there are four electrodes: a cathode, a grid, a screen, and a plate, so spaced and placed that secondary emission from the plate is suppressed without actual power. Because of the manner in which the electrodes are spaced, the electrons which travel to the plate are slowed down when the plate voltage is low, almost to zero velocity in a certain region between screen and plate. For this reason the electrons form a stationary cloud, a *space charge*. The effect of this space charge is to repel secondary electrons emitted from the plate and thus cause them to return to the plate. In this way, secondary emission is suppressed.

Another feature of the beam power tube is the low current drawn by the screen. The screen and the grid are spiral wires wound so that each turn in the screen is shaded from the cathode by a grid turn. This alignment of the screen and the grid causes the electrons to travel in sheets between the turns of the screen so that very few of them strike the screen itself. Because of the effective suppressor action provided by the space charge, and because of the low current drawn by the screen, the beam power tube has the advantages of high power output, high power sensitivity, and high efficiency. The 6L6 is such a beam power tube, designed for use in the power amplifier stages of receivers and speech amplifiers or modulators. Larger tubes employing the beam-power principle are being made by various manufacturers for use in the radio-frequency stages of transmitters. These tubes feature extremely high power sensitivity (a very small amount of driving power is required for a large output), good plate efficiency, and substantial freedom from the requirement for neutralization. Among these transmitting beam power tubes are the T21, the 807, 813, 815, 829B/3E29, HY-69, 2E25, 2E26, 4-125A, 4-250A, and 4X500A.

Special U-H-F Tubes Special element structures for conventional tube types (triodes, pentodes, etc.) have been developed for u-h-f use. These include, in addition to the miniature types discussed in the previous paragraph, the acorn series; 954 through 959 and 9004 and 9005; the disc-seal series, *lighthouse* tubes 2C43, 2C44, 446, and 464 (so-called because of their physical appearance), *oil-can* tube 2C39 (also given this name as a result of appearance) and transmitting disc-seal tube 8010-R. Transmitting types in addition to the disc-seal series for u-h-f work are the 8025 for use up to about 500 Mc. and the 3C37 for c-w use up to about 700 Mc. and pulse use up to about 1300 Mc.

Mercury-Vapor Tubes The space charge of electrons in the vicinity of the cathode in a diode causes the plate-to-cathode voltage drop to be a function of the current being carried between the cathode and the plate. This voltage drop can be rather high when large currents are being passed, causing a considerable amount of energy loss which shows up as plate dissipation. However, this negative space charge can be neutralized by the presence of the proper density of positive ions in the space between the cathode and

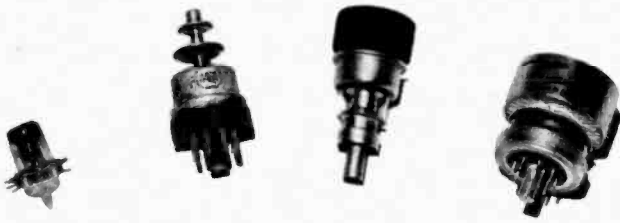

Figure 5.

V-H-F and U-H-F TUBE TYPES.

The tube to the left in this photograph is a 955 "acorn" triode. The 6F4 acorn triode is very similar in appearance to the 955 but has two leads brought out each for the grid and for the plate connection. The second tube is a 446A "lighthouse" triode. The 2C40, 2C43, and 2C44 are more recent examples of the same type tube and are essentially the same in external appearance. The third tube from the left is a 2C39 "oilcan" tube. This tube type is essentially the inverse of the lighthouse variety since the cathode and heater connections come out the small end and the plate is the large finned radiator on the large end. The use of the finned plate radiator makes the oilcan tube capable of approximately 10 times as much plate dissipation as the lighthouse type. The tube to the right is the 4X150A beam tetrode. This tube, a comparatively recent release, is capable of somewhat greater power output than any of the other tube types shown, and is rated for full output at 500 Mc. and at reduced output at frequencies greater than 1000 Mc.

plate. These positive ions can be obtained by the introduction of mercury into the tube. When the filament is heated the mercury vapor pressure within the tube increases to such a value that the electron flow between cathode and plate will ionize enough mercury vapor to neutralize the space charge. Since the ionization potential of mercury vapor under these conditions of temperature and pressure is between 10 and 15 volts, the voltage drop across a mercury-vapor rectifier is substantially constant at this voltage regardless of the current carried up to the maximum rating of the tube.

Mercury-vapor tubes have the disadvantage, however, that they must be operated within a specified temperature range (25° to 70° C.) in order that the mercury vapor pressure within the tube shall be within the proper range. If the temperature is too low, the drop across the tube becomes too high causing immediate overheating and possible damage to the elements. If the temperature is too high, the vapor pressure is too high, and the voltage at which the tube will "flash back" is lowered to the point where destruction of the tube may take place. Since the ambient temperature range specified above is within the normal room temperature range, no trouble will be encountered under normal operating conditions. However, by the substitution of xenon gas for mercury it is possible to produce a rectifier with characteristics comparable to those of the mercury-vapor tube except that the tube is capable of operating over the range from approximately -70° to 90° C. The 3B25 rectifier is an example of this type of tube. Since these tubes are more expensive than mercury-vapor rectifiers, their use is recommended only when extremely low or unusually high temperatures are likely to be encountered in the vicinity of the tubes.

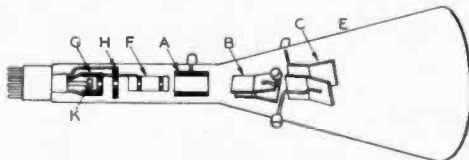

Figure 6.

DIAGRAM OF TYPICAL CATHODE-RAY TUBE.

This tube is of the electrostatic-deflection type and has provision for push-pull deflection since connections to all four deflection plates are brought out. The various components of the tube are described in the text.

Thyatron Tubes If a grid is inserted between the cathode and plate of a mercury-vapor gaseous-conduction rectifier, a negative potential placed upon the added element will increase the plate-to-cathode voltage drop required before the tube will ionize or "fire." The potential upon the control grid will have no effect on the plate-to-cathode drop after the tube has ionized. However, the grid voltage may be adjusted to such a value that conduction will take place only over the desired portion of the cycle of the a-c voltage being impressed upon the plate of the rectifier.

The Cathode-Ray Tube The construction of a typical cathode-ray tube is illustrated in the pictorial diagram of Figure 6. The indirectly heated cathode K releases free electrons when heated by the enclosed filament. The cathode is surrounded by a cylinder G, which has a small hole in its front for the passage of the electron stream. Although this element is not a wire mesh as is the usual grid, it is known by the same name because its action is similar: it controls the electron stream when its negative potential is varied.

Next in order is found the first accelerating anode, H, which resembles another disk or cylinder with a small hole in its center. This electrode is run at a high or moderately high positive voltage, to accelerate the electrons towards the far end of the tube.

The focussing electrode, F, is a sleeve which usually contains two small disks, each with a small hole.

After leaving the focussing electrode, the electrons pass through another accelerating anode, A, which is operated at a high positive potential. In some tubes this electrode is operated at a higher potential than the first accelerating electrode, H, while in other tubes both accelerating electrodes are operated at the same potential.

The electrodes which have been described up to this point constitute the "electron gun," which produces the free electrons and focusses them into a slender, concentrated, rapidly-traveling stream for projection onto the viewing screen.

To make the tube useful, means must be provided for deflecting the electron beam along two axes at right angles to each other. The more common tubes employ electrostatic deflection plates, one pair to exert a force on the beam in the vertical plane and one pair to exert a force in the horizontal plane. These plates are designated as B and C in Figure 6.

Certain of the larger cathode-ray tubes employ magnetic deflection, utilizing an electromagnet in the form of a yoke to deflect the electron beam. However, these tubes are much less common, and therefore this discussion will be confined to those tubes which employ electrostatic deflection.

The fact that the beam is deflected by a magnetic field is important even in an oscilloscope which employs a tube using electrostatic deflection, because it means that precautions must be taken to protect the tube from the transformer fields and sometimes even the earth's magnetic field. This normally is done by incorporating a magnetic shield around the tube and by placing any transformers as far from the tube as possible, oriented to the position which produces minimum effect upon the electron stream.

Standard oscilloscope practice with small cathode-ray tubes calls for connecting one of the B plates and one of the C plates together and to the high voltage accelerating anode. With the newer three-inch tubes and with five-inch tubes and larger all four deflecting plates are commonly used for deflection. The positive high voltage is grounded, instead of the negative as is common practice in amplifiers, etc., in order to permit operation of the deflecting plates at a d-c potential at or near ground.

With most tubes, the spot will be very accurately centered

if all four deflecting plates are at ground potential. However, a means of varying the d-c voltage slightly on one of each pair of electrodes oftentimes is provided so as to permit accurate centering of the "spot" under all conditions.

After the spot is once centered, it is necessary only to apply a positive or negative voltage (with respect to ground) to one of the ungrounded or "free" deflector plates in order to move the spot. If the voltage is positive with respect to ground, the beam will be attracted toward that deflector plate, while if negative the beam and spot will be repulsed. The amount of deflection is directly proportional to the voltage (with respect to ground) that is applied to the free electrode.

With the larger-screen higher-voltage tubes it becomes necessary to place deflecting voltage on both horizontal and both vertical plates. This is done for two reasons: First, the amount of deflection voltage required by the high-voltage tubes is so great that a transmitting tube operating from a plate supply of 1500 to 2000 volts would be required to attain this voltage without distortion. By using push-pull deflection with two tubes feeding the deflection plates, the necessary plate supply voltage for the deflection amplifier is halved. Second, a certain amount of de-focussing of the electron stream is always present on the extreme excursions in deflection voltage when this voltage is applied only to one deflecting plate. When the deflecting voltage is fed in push-pull to both deflecting plates in each plane, there is no de-focussing because the *average* voltage acting on the electron stream is zero, even though the *net* voltage (which causes the deflection) acting on the stream is twice that on either plate.

Cathode-ray tubes are obtainable with any one of several types of screen material, each having its characteristic "persistence" and fluorescing color. The persistence is the degree to which the screen material will glow after being bombarded with electrons. The fluorescent material will give off light for an instant after the bombardment is terminated, and the longer the time the longer the "persistence."

Cold-Cathode Tubes—VR Tubes Cold-cathode tubes are devices in which, as the name would imply, external heating of the cathode is not necessary to initiate current flow between cathode and plate. Such tubes are available both in the form of diodes and triodes and always

have a certain amount of controlled gas content. Initial breakdown of the gas within the tube is caused, after anode voltage is applied, by the high potential gradient between a point, which serves as the cathode, and an element of much larger area which serves as the anode or plate. It always takes a certain amount more voltage between cathode and anode to initiate the discharge than to sustain it continuously.

The most commonly used cold-cathode tubes are the VR-tube series of voltage regulators. The application of these tubes to the problem of voltage regulation is discussed in Chapter 25, Power Supplies. In addition to the cold-cathode diodes or VR tubes, several cold-cathode triodes, of which the OA4G is an example, are available. In these tubes the ionic discharge within the gas is initiated by the application of an r-f or a-c voltage of 50 to 100 volts peak to a starter anode. These tubes are normally used in remote control devices where it is desired that no energy be taken by the controlled device until it is desired that the controlled device be completely operative.

The Magnetron The magnetron is an s-h-f oscillator tube normally employed where very high values of peak power or moderate amounts of average power are required in the range from perhaps 700 Mc. to 30,000 Mc. Special magnetrons were developed for wartime use in radar equipments which had peak power capabilities of several million watts (megawatts) output at frequencies in the vicinity of 3000 Mc. The normal duty cycle of operation of these radar equipments was approximately 1/10 of one per cent (the tube operated about 1/1000 of the time and rested for the balance of the operating period) so that the average power output of these magnetrons was in the vicinity of 1000 watts.

In its simplest form the magnetron tube is a filament-type diode with two half-cylindrical plates or anodes situated coaxially with respect to the filament. The construction is illustrated in Figure 7A. The anodes of the magnetron are connected to a resonant circuit as illustrated in Figure 7B. The tube is surrounded by an electromagnet coil which, in turn, is connected to a low-voltage d-c energizing source through a rheostat R for controlling the strength of the magnetic field. The field coil is oriented so that the lines of magnetic force it sets up are parallel to the axis of the electrodes.

Under the influence of the strong magnetic field, electrons leaving the filament are deflected from their normal paths and move in circular orbits within the anode cylinder. This effect results in a negative resistance which sustains oscillations. The oscillation frequency is very nearly the value determined by L and C, in Figure 7B. In other magnetron circuits,

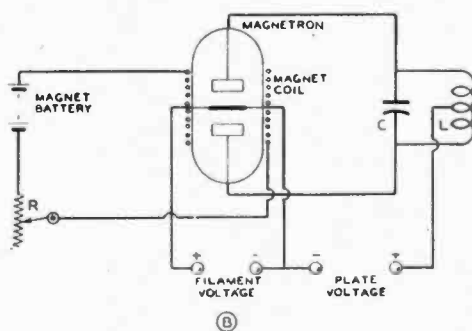
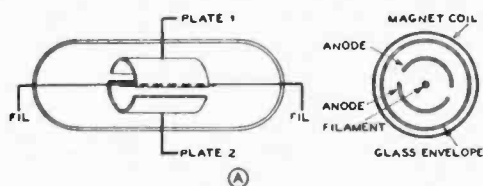

Figure 7.

SIMPLE MAGNETRON CIRCUIT.

An external tank circuit is used with this type of relatively low-frequency magnetron oscillator.

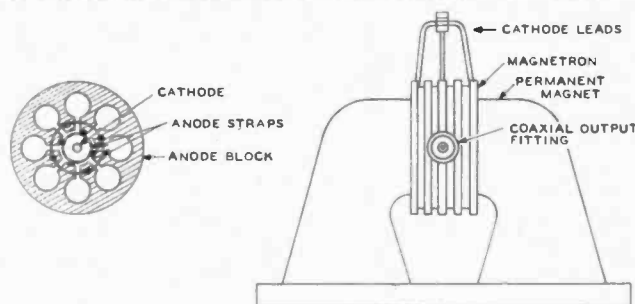

Figure 8.

MODERN MULTI-CAVITY MAGNETRON.

Illustrated is an external-anode multi-cavity strapped magnetron of the type commonly used in radar equipment for the 10-cm. range. A permanent magnet of the general type used with such a magnetron is shown in the right-hand portion of the drawing with the magnetron in place between the pole pieces of the magnet.

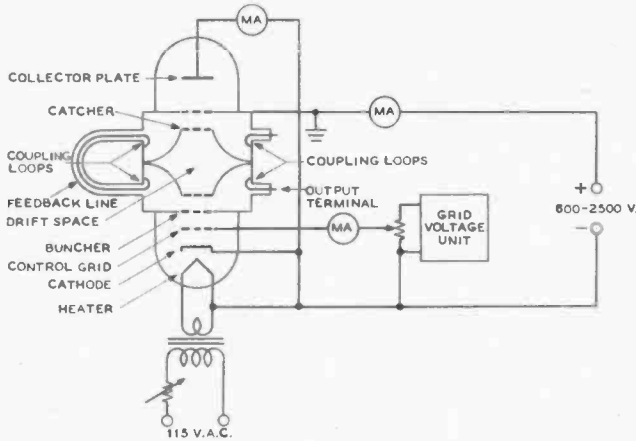

Figure 9.
TWO-CAVITY KLYSTRON OSCILLATOR.

A conventional two-cavity klystron is shown with the feedback loop connected between the two cavities so that the tube may be used as an oscillator. A representation of the type of power supply required for such a tube is also shown.

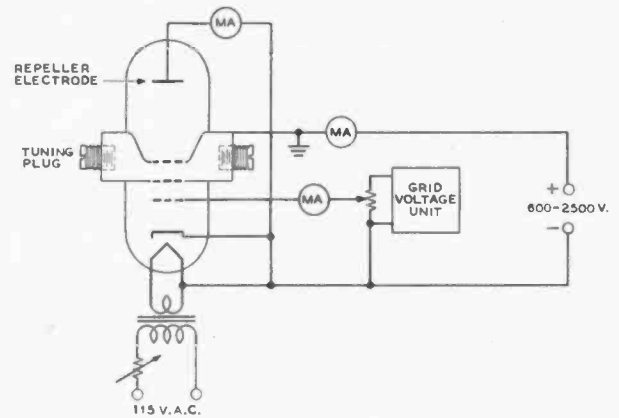

Figure 10.
REFLEX KLYSTRON OSCILLATOR.

A conventional reflex klystron oscillator of the type commonly used as local oscillator in superheterodynes for the range above about 2000 Mc. is shown. Frequency modulation of the oscillator, or a.f.c. for local-oscillator operation is usually obtained by varying the bias on the repeller electrode.

the frequency may be governed by the electron rotation, no external tuned circuits being employed. Wavelengths of less than 1 centimeter have been produced with such circuits.

More complex magnetron tubes employ no external tuned circuit, but utilize instead one or more resonant cavities which are integral with the anode structure. Figure 8 shows a magnetron of this type having a multi-cellular anode of eight cavities. It will be noted, also, that alternate cavities (which would operate at the same polarity when the tube is oscillating) are strapped together. Strapping was found to improve the efficiency and stability of high-power radar magnetrons. In most radar applications of magnetron oscillators a powerful permanent magnet of controlled characteristics is employed to supply the magnetic field rather than to use an electromagnet.

The Klystron The klystron is a specialized microwave tube which depends upon velocity modulation of an electron stream for its operation. In various sizes, this tube is employed as a voltage amplifier, power amplifier, superheterodyne oscillator or mixer, detector, and frequency multiplier. The klystron removes the necessity (so important in conventional grid-controlled tubes) of limiting electron transit time to a fraction of the time required for one microwave cycle.

In addition to heater, cathode, and control grid (which, together, form an electron gun), and a collector plate, two cavity resonators of reentrant shape are included in the klystron tube. One of these, known as the *buncher*, immediately follows the control grid. The electron beam from the gun section enters the buncher through a grid in the aperture in one of its reentrant walls and leaves through a similar grid aperture in the other parallel reentrant wall. The second cavity, known as the *catcher*, follows the buncher and has a similar pair of grids in its own parallel reentrant walls. Buncher and catcher are mounted "back-to-back" to provide a *drift space* for the electron beam passing from one cavity to the other.

The electron beam from the gun comes under the influence of the electrostatic field between the two buncher grids as the beam passes through the buncher apertures. The grid field is oscillating if the buncher cavity is being excited by oscillating energy, and this field is parallel to the electron beam which it acts alternately to accelerate and retard. The beam thus becomes velocity-modulated.

When the electron beam reaches the drift space, where there is no field, those electrons which have been sped up on one-

half-cycle overtake those immediately ahead which were slowed down on the other half-cycle. In this way, the beam electrons become bunched together. As the bunched groups pass through the two grids of the catcher cavity, they impart some of their energy to these grids. The catcher grid-space is charged to different voltage levels by the passing electron bunches, and a corresponding oscillating field is set up in the catcher cavity. The catcher is designed to resonate at the frequency of the velocity-modulated beam.

In the klystron amplifier, energy delivered by the buncher to the catcher grids is greater than that applied to the buncher cavity by the input signal. In the klystron oscillator (Figure 9), a feedback loop connects the two cavities. Coupling to either buncher or catcher is provided by small loops which enter the cavities by way of concentric lines, as shown in Figure 9.

The klystron is an electron-coupled device. When used as an oscillator, its output voltage is rich in harmonics. Klystron oscillators of various types afford power outputs ranging from less than 1 watt to several hundred watts. Beam efficiencies vary between 50 and 75 percent. Frequency may be shifted to some extent by varying the beam voltage. Tuning is carried on mechanically in some klystrons by altering (by means of knob settings) the shape of the resonant cavity.

The two-cavity klystron as described in the preceding paragraphs is primarily used as a transmitting device since quite reasonable amounts of power are made available in its output circuit. However, for applications where a much smaller amount of power is required—power levels from milliwatts to a watt or two—for low-power transmitters, receiver local oscillators, etc., another type of klystron having only a single cavity is more frequently used.

The theory of operation of the single-cavity klystron is essentially the same as the multi-cavity type with the exception that the velocity-modulated electron beam, after having left the "buncher" cavity is reflected back into the area of the buncher again by a repeller electrode as illustrated in Figure 10. The potentials on the various electrodes are adjusted to the value such that proper bunching of the electron beam will take place just as a particular portion of the velocity-modulated beam re-enters the area of the resonant cavity. Since this type of klystron has only one circuit it can be used only as an oscillator and not as an amplifier. Effective modulation of the frequency of a single-cavity klystron for FM work can be obtained by modulating the repeller electrode voltage.

Vacuum Tube Amplifiers

THE ability of the control grid of a vacuum tube to control large amounts of plate power with a small amount of grid energy allows the vacuum tube to be used as an amplifier. It is this ability of vacuum tubes to amplify an extremely small amount of energy up to almost any level without change in anything except amplitude which makes the vacuum tube such an extremely valuable adjunct to modern electronics and communication.

Symbols for Vacuum-Tube Parameters As an assistance in simplifying and shortening expressions involving vacuum-tube parameters, the following symbols will be used throughout this book:

Tube Constants

- μ —amplification factor
- R_p —plate resistance
- G_m —transconductance
- μ_{sc} —grid-screen mu factor
- G_c —conversion transconductance (mixer tube)

Interelectrode Capacitances

- C_{ck} —grid-cathode capacitance
- C_{cp} —grid-plate capacitance
- C_{pk} —plate-cathode capacitance
- C_{in} —Input capacitance (tetrode or pentode)
- C_{out} —output capacitance (tetrode or pentode)

Electrode Potentials

- E_{hb} —d-c plate supply voltage (a positive quantity)
- E_{gc} —d-c grid supply voltage (a negative quantity)
- E_{gcm} —peak grid excitation voltage ($1/2$ total peak-to-peak grid swing)
- E_{pim} —peak plate voltage ($1/2$ total peak-to-peak plate swing)
- e_p —instantaneous plate potential
- e_g —instantaneous grid potential
- e_{pmin} —minimum instantaneous plate voltage
- e_{gmp} —maximum positive instantaneous grid voltage
- E_p —static plate voltage
- E_g —static grid voltage
- e_{co} —cut off bias

Electrode Currents

- I_b —average plate current
- I_g —average grid current
- I_{pm} —peak fundamental plate current
- i_{pmax} —maximum instantaneous plate current
- i_{gmax} —maximum instantaneous grid current
- I_p —static plate current
- I_g —static grid current

Other Symbols

- P_i —plate power input
- P_o —plate power output
- P_p —plate dissipation
- P_g —grid driving power (grid plus bias losses)
- P_g —grid dissipation
- η_p —plate efficiency (expressed as a decimal)
- θ_p —one-half angle of plate current flow
- θ_g —one-half angle of grid current flow
- R_l —load resistance
- Z_l —load impedance

4-1 Vacuum-Tube Constants

The relationships between certain of the electrode potentials and currents within a vacuum tube are reasonably constant under specified conditions of operation. These relationships are called *vacuum-tube constants* and are listed in charts of vacuum-tube characteristics such as given in Chapters 16 and 17 and published by vacuum-tube manufacturers. The defining expressions for these constants are given in the following paragraphs.

Amplification Factor or Mu The amplification factor or mu (μ) of a vacuum tube is the ratio of a change in plate voltage to a change in grid voltage, either of which will cause the same change in plate current. Expressed as an equation:

$$\mu = - \frac{\Delta E_p}{\Delta E_g} \quad I_p = \text{constant} \quad \Delta = \text{small change}$$

The μ can be determined experimentally by making a very slight change in the plate voltage, thus slightly changing the

plate current. The plate current is then returned to its original value by a change in the grid voltage. The ratio of the change in plate voltage to the change in grid voltage is the μ of the tube under the operating conditions chosen for the test.

Plate Resistance The plate resistance of a vacuum tube is the ratio of a change in plate voltage to the change in plate current which the change in plate voltage produces. To be accurate, the changes should be very small with respect to the operating values. Expressed as an equation:

$$R_p = \frac{\Delta E_p}{\Delta I_p} \quad E_g = \text{constant} \quad \Delta = \text{small change}$$

The plate resistance can also be determined by the experiment mentioned above. By noting the change in plate current as it occurs when the plate voltage is changed (grid voltage held constant), and by dividing the latter by the former, the plate resistance can be determined. Plate resistance is expressed in ohms.

Transconductance The mutual conductance, also referred to as *transconductance*, is the ratio of a change in the plate current to the change in grid voltage which brought about the plate current change, the plate voltage being held constant. Expressed as an equation:

$$G_m = \frac{\Delta I_p}{\Delta E_g} \quad E_p = \text{constant} \quad \Delta = \text{small change}$$

The transconductance is also numerically equal to the amplification factor divided by the plate resistance. $G_m = \mu/R_p$.

Transconductance is most commonly expressed in microreciprocal-ohms or *micromhos*. However, since transconductance expresses change in plate current as a function of a change in grid voltage, a tube is often said to have a transconductance of so many milliamperes-per-volt. If the transconductance in milliamperes-per-volt is multiplied by 1000 it will then be expressed in micromhos. Thus the transconductance of a 6A3 could be called either 5.25 ma./volt or 5250 micromhos.

Grid-Screen Mu Factor The grid-screen mu factor (μ_{sg}) is analogous to the amplification factor in a triode, except that the screen of a pentode or tetrode is substituted for the plate of a triode. μ_{sg} denotes the ratio of a change in grid voltage to a change in screen voltage, each of which will produce the same change in screen current. Expressed as an equation:

$$\mu_{sg} = - \frac{\Delta E_{sg}}{\Delta E_g} \quad I_{sg} = \text{constant} \quad \Delta = \text{small change}$$

The grid-screen mu factor is important in determining the operating bias of a tetrode or pentode tube. The relationship between control-grid potential and screen potential determines the plate current of the tube as well as the screen current since the plate current is essentially independent of the plate voltage

in tubes of this type. In other words, when the tube is operated at cutoff bias as determined by the screen voltage and the grid-screen mu factor (determined in the same way as with a triode, by dividing the operating voltage by the mu factor) the plate current will be substantially at cutoff as will be the screen current. The grid-screen mu factor is numerically equal to the amplification factor of the same tetrode or pentode tube when triode connected.

Conversion Conductance The conversion conductance (G_c) is of interest only in the case of mixer tubes, or of conventional triodes, tetrodes, or pentodes operating as frequency converters. The conversion conductance is the ratio of a change in the signal-grid voltage at the input frequency to a change in the output current at the converted frequency. Hence G_c in a mixer is essentially the same as transconductance in amplifier with the exception that the input signal and the output current are on different frequencies. The value of G_c in conventional mixer tubes is from 300 to 500 micromhos. The value of G_c in an amplifier tube operated as a mixer is approximately 0.3 times the G_m of the tube operated as an amplifier. The voltage gain of a mixer stage is equal to $G_c Z_L$, where Z_L is the impedance of the plate load into which the mixer tube operates.

Interelectrode Capacitances The values of interelectrode capacitance published in vacuum-tube tables are the static values measured, in the case of triode for example, as shown in Figure 1. The static capacitances are simply as shown in the drawing, but when a tube is operating as amplifier there is another consideration known as *Miller Effect* which causes the dynamic input capacitance to be different from the static value. The output capacitance of an amplifier is essentially the same as the static value such as is given in the published tube tables. The grid-to-plate capacitance is also the same as the published static value, but since the C_{gp} acts as a small capacitance coupling energy back from the plate circuit to the grid circuit, the dynamic input capacitance is equal to the static value plus an amount (frequently much greater in the case of a triode) determined by the gain of the stage, the plate load impedance, and the C_{gp} feedback capacitance. The total value for an audio amplifier stage can be expressed in the following equation:

$$C_{gk}(\text{dynamic}) = C_{gk}(\text{static}) + (A + 1) C_{gp}$$

where C_{gk} is the grid-to-cathode capacitance, C_{gp} is the grid-to-plate capacitance, and A is the stage gain. This expression assumes that the vacuum tube is operating into a resistive load such as would be the case with an audio stage working into a resistance plate load in the middle audio range.

The more complete expression for the input admittance (vector sum of capacitance and resistance) of an amplifier operating into any type of plate load is as follows:

$$\text{Input capacitance} = C_{gk} + (1 + A \cos \theta) C_{gp}$$

$$\text{Input resistance} = - \left(\frac{1}{\omega C_{gp}} \right) A \sin \theta$$

Where: C_{gk} = grid-to-cathode capacitance
 C_{gp} = grid-to-plate capacitance
 A = voltage amplification of the tube alone
 θ = phase angle of the plate load impedance, positive for inductive loads, negative for capacitive

It can be seen from the above that if the plate load impedance of the stage is capacitive or inductive, there will be a resistive component in the input admittance of the stage. The

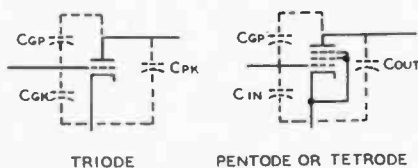

Figure 1. Static Interelectrode Capacitances Within a Triode, Pentode, or Tetrode.

resistive component of the input admittance will be positive (tending to load the circuit feeding the grid) if the load impedance of the plate is capacitive, or it will be negative (tending to make the stage oscillate) if the load impedance of the plate is inductive.

Neutralization of Interelectrode Capacitance Neutralization of the effects of interelectrode capacitance is employed most frequently in the case of radio frequency power amplifiers. Methods of accomplishing neutralization will be discussed in Chapter 6, *Generation of Radio-Frequency Energy*. Before the introduction of the tetrode and pentode tube, triodes were employed as neutralized Class A amplifiers in receivers. This practice has been largely superseded in the present state of the art through the use of tetrode and pentode tubes in which the C_{vp} or feedback capacitance has been reduced to such a low value that neutralization of its effects is not necessary to prevent oscillation and instability.

CLASSES AND TYPES OF VACUUM-TUBE AMPLIFIERS

Vacuum-tube amplifiers are grouped into various classes and sub-classes according to the type of work they are intended to perform. The difference between the various classes is determined primarily by the value of average grid bias employed and the maximum value of the exciting signal to be impressed upon the grid.

Class A Amplifier A Class A amplifier is an amplifier biased and supplied with excitation of such amplitude that plate current flows continuously (360° of the exciting voltage waveshape) and grid current does not flow at any time. Such an amplifier is normally operated in the center of the grid-voltage plate-current transfer characteristic and gives an output waveshape which is a substantial replica of the input waveshape.

Class A₁ Amplifier This is another term applied to the Class A amplifier in which grid current does not flow over any portion of the input wave cycle.

Class A₂ Amplifier This is a Class A amplifier operated under such conditions that the grid is driven positive over a portion of the input voltage cycle, but plate current still flows over the entire cycle.

Class AB₁ Amplifier This is an amplifier operated under such conditions of grid bias and exciting voltage that plate current flows for more than one-half the input

voltage cycle but for less than the complete cycle. In other words the operating angle of plate current flow is appreciably greater than 180° but less than 360° . The suffix 1 indicates that grid current does not flow over any portion of the input cycle.

Class AB₂ Amplifier A Class AB₂ amplifier is operated under essentially the same conditions of grid bias as the Class AB₁ amplifier mentioned above, but the exciting voltage is of such amplitude that grid current flows over an appreciable portion of the input wave cycle.

Class B Amplifier A Class B amplifier is biased substantially to cutoff of plate current (without exciting voltage) so that plate current flows essentially over one-half the input voltage cycle. The operating angle of plate current flow is essentially 180° . The Class B amplifier is almost always excited to such an extent that grid current flows.

Class C Amplifier A Class C amplifier is biased to a value greater than the value required for plate current cutoff and is excited with a signal of such amplitude that grid current flows over an appreciable period of the input voltage waveshape. The angle of plate current flow in a Class C amplifier is appreciably less than 180° , or in other words, plate current flows appreciably less than one-half the time. Actually, the conventional operating conditions for a Class C amplifier are such that plate current flows for 120° to 150° of the exciting voltage waveshape.

Types of Amplifiers There are three general types of amplifier circuits in use. These types are classified on the basis of the *return* for the input and output circuits. Conventional amplifiers are called *cathode return* amplifiers since the cathode is effectively grounded and acts as the common return for both the input and output circuits. The second type is known as a plate return amplifier or *cathode follower* since the plate circuit is effectively at ground for the input and output signal voltages and the output voltage or power is taken between cathode and plate. The third type is called a *grid-return* or *grounded-grid* amplifier since the grid is effectively at ground potential for input and output signals and output is taken between grid and plate.

Chapter Organization

As an assistance to the reader, the balance of this chapter has been subdivided into six main sections: Audio-Frequency Voltage Amplifiers, Audio-Frequency Power Amplifiers, Radio-Frequency Voltage Amplifiers, Radio-Frequency Power Amplifiers, Feedback Amplifiers, Video-Frequency Amplifiers.

AUDIO-FREQUENCY VOLTAGE AMPLIFIERS

Audio-frequency voltage amplifiers are most frequently employed in two general applications: First, to build up the voltage output of the detector or demodulator in a receiver to a level sufficient to excite the grid of the audio-frequency power amplifier which drives the loudspeaker; and second, to increase the voltage output of a microphone or other type of pickup to a level sufficient to excite the grid of an audio-frequency power amplifier.

4-2 Resistance-Capacitance Coupled Audio-Frequency Amplifiers

Present practice in the design of audio-frequency voltage amplifiers is almost exclusively to use resistance-capacitance

coupling between the low-level stages. Both triodes and pentodes are used; triode amplifier stages will be discussed first.

R-C Coupled Triode Stages Figure 2 illustrates the standard circuit for a resistance-capacitance coupled amplifier stage utilizing a triode tube with cathode bias. In conventional audio-frequency amplifier design such stages are used at medium voltage levels (from 0.01 to 5 volts peak on the grid of the tube) and use medium- μ triodes such as the 6J5 or high- μ triodes such as the 6SF5 or 6SL7-GT. Normal voltage gain for a single stage of this type is from 10 to 70, depending upon the tube chosen and its operating conditions. Triode tubes are normally used in the last voltage amplifier

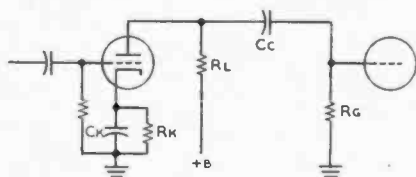

Figure 2.
Standard circuit for resistance-capacitance coupled triode amplifier stage. Values of circuit constants can be determined with the aid of Table I.

stage of an R-C amplifier since their harmonic distortion with large output voltage (25 to 75 volts) is less than with a pentode tube.

Voltage Gain per Stage The voltage gain per stage of a resistance-capacitance coupled triode amplifier can be calculated with the aid of the equivalent circuits and expressions for the mid-frequency, high-frequency, and low-frequency range given in Figure 3.

A triode R-C coupled amplifier stage is normally operated with values of cathode resistor and plate load resistor such that the actual voltage on the tube is approximately one-half the d-c plate supply voltage. To assist the designer of such stages, Table I, which lists the recommended operating conditions for triode amplifier stages using conventional tube types for such stages, is included herewith. If it is desired to use a tube not included in Table I, additional data on operating conditions for less commonly used tubes is published in the RCA Tube Handbook. It is assumed, in the case of the gain equations of Figure 3, that the cathode by-pass capacitor, C_k , has a reactance that is low with respect to the cathode resistor at the lowest frequency to be passed by the amplifier stage.

R-C Coupled Pentode Stages Figure 4 illustrates the standard circuit for a resistance-capacitance coupled pentode amplifier stage. Cathode bias is used and the screen voltage is supplied through a dropping resistor from the plate voltage supply. In conventional audio-frequency amplifier design such stages are normally used at low voltage

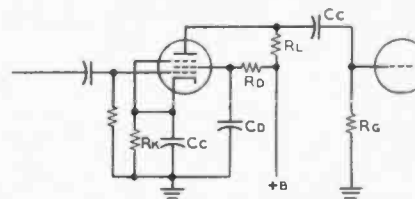

Figure 4.
Standard circuit for R-C coupled pentode amplifier stage. Values of circuit constants can be determined with the aid of Table II.

levels (from 0.00001 to 0.1 volts peak on the grid of the tube) and use moderate- G_m pentodes such as the 6SJ7. Normal voltage gain for a stage of this type is from 60 to 250, depending upon the tube chosen and its operating conditions. Pentode tubes are ordinarily used in the first stage of an R-C amplifier where the high gain which they afford is of greatest advantage and where only a small voltage output is required from the stage.

The voltage gain per stage of a resistance-capacitance coupled pentode amplifier can be calculated with the aid of the equivalent circuits and expressions for the mid-frequency, high-frequency, and low-frequency range given in Figure 5.

To assist the designer of such stages, Table II, which lists the recommended operating conditions for pentode amplifier stages using conventional tubes, is included herewith. If it is desired to use a tube not included in Table II, additional data on operating conditions for less commonly used types of tubes is published in the RCA Tube Handbook. It is assumed, in the case of the gain equations of Figure 5, that the cathode by-pass capacitor, C_k , has a reactance that is low with respect to the cathode resistor at the lowest frequency to be passed by the stage. It is additionally assumed that the reactance of the screen by-pass capacitor, C_s , is low with respect to the screen dropping resistor, R_{sd} , at the lowest frequency to be passed by the amplifier stage.

Cascade Voltage Amplifier Stages When voltage amplifier stages are operated in such a manner that the output voltage of the first is fed to the grid of the

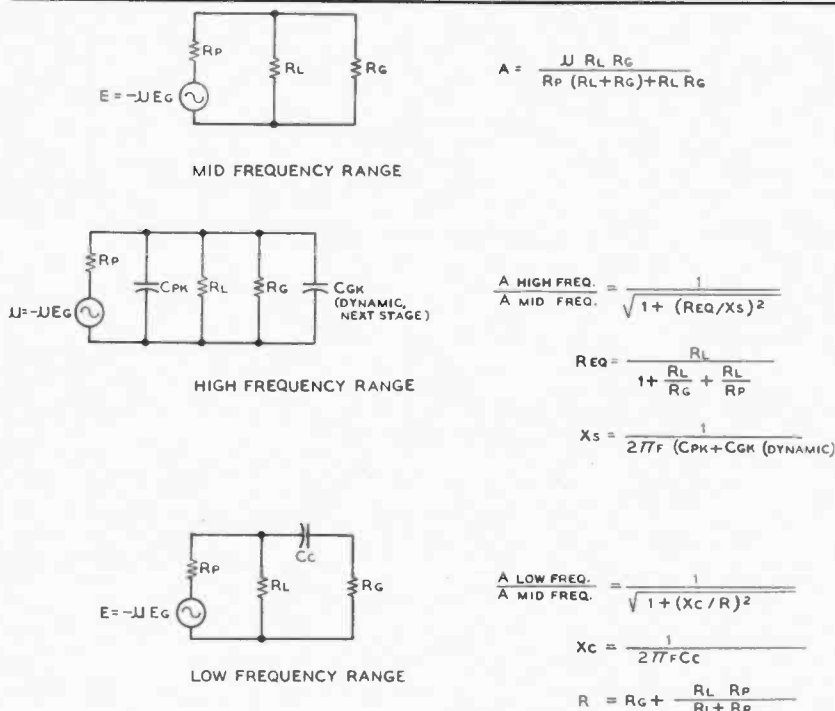

Figure 3.
Equivalent circuits and gain equations for a triode R-C coupled amplifier stage. In using these equations, be sure to use the values of μ and R_p which are proper for the static plate current with which the tube will operate. These values can be obtained from curves published in the RCA Tube Handbook.

second, and so forth, such stages are said to be cascaded. The total voltage gain of cascaded amplifier stages is obtained by taking the product of the voltage gains of each of the successive stages.

Sometimes the voltage gain of an amplifier stage is rated in decibels. Voltage gain is converted into decibels gain through the use of the following expression: $db = 20 \log_{10} A$, where A is the voltage gain of the stage. The total gain of cascaded voltage amplifier stages can be obtained by adding the number of decibels gain in each of the cascaded stages. This subject is covered in Chapter 15, Reference Data.

4-3 Other Interstage Coupling Methods

Figure 6 illustrates, in addition to resistance-capacitance interstage coupling, seven additional methods in which cou-

pling between two successive stages of an audio-frequency amplifier may be accomplished. Although resistance-capacitance coupling is most commonly used, there are certain circuit conditions wherein coupling methods other than resistance capacitance are more effective.

Transformer Coupling Transformer coupling, as illustrated in Figure 6B, is seldom used at the present time between two successive single-ended stages of an audio amplifier.

There are several reasons why resistance coupling is favored over transformer coupling between two successive single-ended stages. These are: (1) a transformer having frequency characteristics comparable with a properly designed R-C stage is very expensive; (2) transformers, unless they are very well shielded, will pick up inductive hum from nearby power and filament transformers; (3) the phase characteristics of step-up interstage transformers are very poor, making very difficult the inclusion of a transformer of this type within a feedback loop; and (4) transformers are heavy.

However, there is one circuit application where a step-up interstage transformer is of considerable assistance to the designer; this is the case where it is desired to obtain a large amount of voltage to excite the grid of a cathode follower or of a high-power Class A amplifier from a tube operating at a moderate plate voltage. Under these conditions it is possible to obtain a peak voltage on the secondary of the transformer of a value somewhat greater than the d-c plate supply voltage of the tube supplying the primary of the transformer.

Push-Pull Transformer Interstage Coupling Push-pull transformer coupling between two stages is illustrated in Figure 6C.

This interstage coupling arrangement is fairly commonly used. The system is particularly effective when it is desired, as in the system just described, to obtain a fairly high voltage to excite the grids of a high-power audio stage. The arrangement is also very good when it is desired to apply feedback to the grids of the push-pull stage by applying the feedback voltage to the low-potential sides of the two push-pull secondaries.

Impedance Coupling Impedance coupling between two stages is shown in Figure 6D. This circuit arrangement is seldom used, but it offers one strong advantage over R-C interstage coupling.

This advantage is the fact that, since the operating voltage on the tube with the impedance in the plate circuit is the plate supply voltage, it is possible to obtain approximately twice the peak voltage output that it is

TABLE I RESISTANCE-CAPACITANCE COUPLED TRIODE AUDIO VOLTAGE AMPLIFIER

Table with columns for tube types (6J5, 6J5-G, 7A4, 6F8-G, 6SN7-GT, 7N7), resistor values (47K, 100K, 270K, 100K, 270K, 470K), and various performance metrics (Rb, RGF, Rk, Ib, Ec, Esig, Eout, Gain, Dist).

Table with columns for tube types (6C4, 7F7, 6SL7-GT, 7F8), resistor values (47K, 100K, 270K, 100K, 270K, 470K), and various performance metrics (Rb, RGF, Rk, Ib, Ec, Esig, Eout, Gain, Dist).

Table with columns for tube types (6C8-G, 6F5, 6F5-G, 6SF5, 7B4), resistor values (100K, 250K, 500K, 100K, 250K, 500K), and various performance metrics (Rb, RGF, Rk, Ck, C, Eo, Gain).

Table with columns for tube types (6N7, 6N7-G, 6A6, 53, 6Q7, 6Q7-G), resistor values (100K, 250K, 500K, 100K, 250K, 500K), and various performance metrics (Rb, RGF, Rk, Ck, C, Eo, Gain).

Table with columns for tube types (6R7, 6R7-G, 6S7), resistor values (50K, 100K, 250K, 100K, 250K, 500K), and various performance metrics (Rb, RGF, Rk, Ck, C, Eo, Gain).

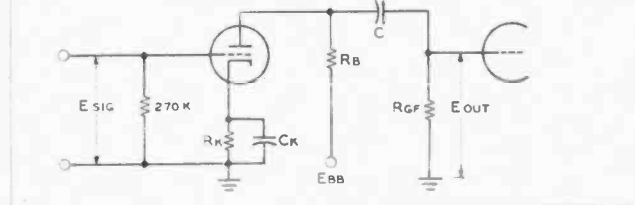
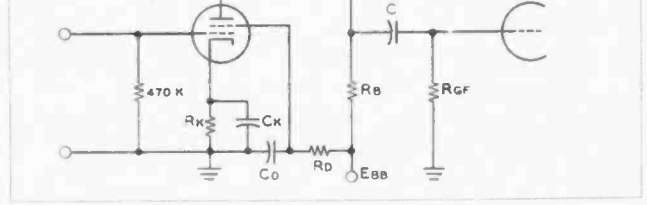
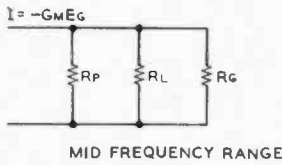

TABLE II RESISTANCE-CAPACITANCE COUPLED PENTODE AUDIO VOLTAGE AMPLIFIER

Table with columns for tube types (6SJ7, 6J7, 6J7-G, 6W7-G, 6B8, 6B8-G, 6B7), resistor values (100K, 250K, 500K), and various performance metrics (Rb, RGF, Rd, Rk, Cd, C, Eo, Gain).





$$A = G_m R_{EQ}$$

$$R_{EQ} = \frac{R_L}{1 + \frac{R_L}{R_g} + \frac{R_L}{R_p}}$$

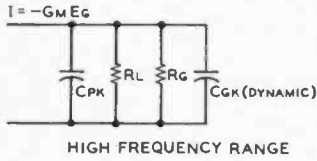

$$\frac{A_{HIGH\ FREQ.}}{A_{MID\ FREQ.}} = \frac{1}{\sqrt{1 + (R_{EQ}/X_s)^2}}$$

$$R_{EQ} = \frac{R_L}{1 + \frac{R_L}{R_g} + \frac{R_L}{R_p}}$$

$$X_s = \frac{1}{2\pi f (C_{PK} + C_{GK} \text{ (DYNAMIC)})}$$

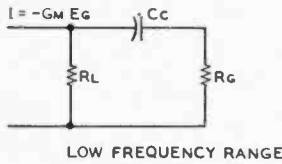

$$\frac{A_{LOW\ FREQ.}}{A_{MID\ FREQ.}} = \frac{1}{\sqrt{1 + (X_c/R)^2}}$$

$$X_c = \frac{1}{2\pi f C_c}$$

$$R = R_g + \frac{R_L R_p}{R_L + R_p}$$

Figure 5.

Equivalent circuits and gain equations for a pentode R-C coupled amplifier stage. In using these equations be sure to use the values of G_m and R_p which are proper for the static plate voltage, screen voltage, grid bias and plate current with which the tube will operate. These values can be obtained from curves in the RCA Tube Handbook.

possible to attain with R-C coupling. This is because, as has been mentioned before, the d-c plate voltage on an R-C stage is approximately one half the plate supply voltage.

Impedance-Transformer and Resistance-Transformer Coupling

These two circuit arrangements, illustrated in Figures 6E and 6F, are employed when it is desired to use transformer coupling for the reasons cited above, but where it is desired that the d-c plate current of the amplifier stage be isolated from the primary of the coupling transformer. With most types of high-permeability wide-response transformers it is necessary that there be no direct-current flow through the windings of the transformer. The impedance-transformer arrangement of Figure 6E will give a higher voltage output from the stage but is not often used since the plate coupling impedance (choke) must have very high inductance and very low distributed capacitance in order not to restrict the range of the transformer which it and its associated tube feed. The resistance-transformer arrangement of Figure 6F is ordinarily quite satisfactory where it is desired to feed a transformer from a voltage amplifier stage with no d-c in the transformer primary.

Cathode Coupling

The cathode coupling arrangement of Figure 6G has been widely used only comparatively recently. One outstanding characteristic of such a circuit is that there is no phase reversal between the grid and the

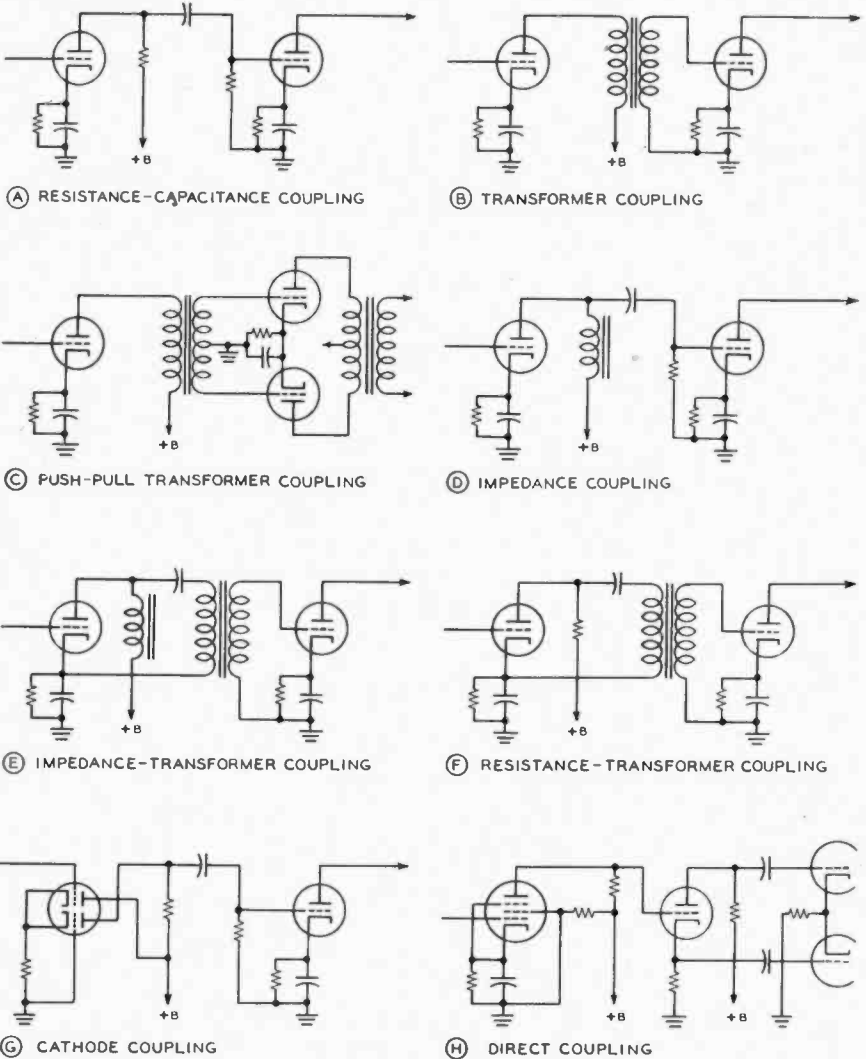
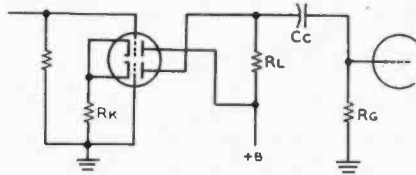

Figure 6. Interstage Coupling Methods for Audio-Frequency Voltage Amplifiers



$$G_m' = -G_m \frac{G}{2G+1}$$

$$R_p' = R_p \frac{2G+1}{G+1}$$

$$\mu' = -\mu \frac{G}{G+1}$$

$$G = R_k G_m (1 + \frac{1}{\mu})$$

$$R_k = \text{CATHODE RESISTOR}$$

$$G_m = G_m \text{ OF EACH TUBE}$$

$$\mu = \mu \text{ OF EACH TUBE}$$

$$R_p = R_p \text{ OF EACH TUBE}$$

EQUIVALENT FACTORS INDICATED ABOVE BY (') ARE THOSE OBTAINED BY USING AN AMPLIFIER WITH A PAIR OF SIMILAR TUBE TYPES IN CIRCUIT SHOWN ABOVE.

Figure 7.

Equivalent Factors for a Pair of Similar Triodes Operating as a Cathode-Coupled A-F Voltage Amplifier.

plate circuit. All other common types of interstage coupling are accompanied by a 180° phase reversal between the grid circuit and the plate circuit of the tube.

Figure 7 gives the expressions for determining the appropriate factors for an equivalent triode obtained through the use of a pair of similar triodes connected in the cathode-coupled circuit shown. With these equivalent triode factors it is possible to use the expressions shown in Figure 3 to determine the gain of the stage at different frequencies. The input capacitance of such a stage is less than that of one of the triodes, the effective grid-to-plate capacitance is very much less (it is so much less that such a stage may be used as an r-f amplifier without neutralization), and the output capacitance is approximately equal to the grid-to-plate capacitance of one of the triode sections. This circuit is particularly effective with tubes such as the 6J6, 6N7, and 6SN7-GT which have two similar triodes in one envelope. An appropriate value of cathode resistor to use for such a stage is the value which would be used for the cathode resistor of a conventional amplifier using *one* of the same type tubes with the values of plate voltage and load resistance to be used for the cathode-coupled stage.

Inspection of the equations in Figure 7 shows that as the cathode resistor is made smaller, to approach zero, the G_m approaches zero, the plate resistance approaches the R_p of one tube, and the μ approaches zero. As the cathode resistor is made very large the G_m approaches one half that of a single tube of the same type, the plate resistance approaches twice that of one tube, and the μ approaches the same value as one tube. But since the G_m of each tube decreases as the cathode resistor is made larger (since the plate current will decrease on each tube) the optimum value of cathode resistor will be found to be in the vicinity of the value mentioned in the previous paragraph.

Direct Coupling Direct coupling between successive amplifier stages (plate of first stage connected directly to the grid of the succeeding stage) is complicated by the fact that the grid of an amplifier stage must be operated at an average negative potential with respect to the cathode of that stage. However, if the cathode of the second amplifier stage can be operated at a potential more positive than the plate of the preceding stage by the amount of the grid bias on the second amplifier stage, this direct connection between the plate of one stage and the grid of the succeeding stage can be used. Figure 6H illustrates an application of this principle in the coupling of a pentode amplifier stage to the grid of a "hot-cathode" phase inverter. In this arrangement the values of cathode, screen, and plate resistor in the pentode stage are chosen such that the plate of the pentode is at approximately

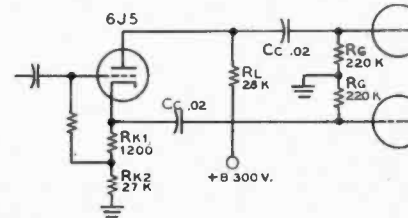

(A) "HOT CATHODE" PHASE INVERTER

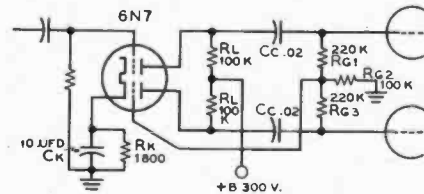

(B) "FLOATING PARAPHRASE" PHASE INVERTER

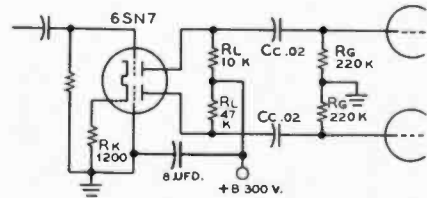

(C) CATHODE COUPLED PHASE INVERTER

Figure 8.

Three Popular Phase-Inverter Circuits with Recommended Values for Circuit Components.

0.3 times the plate supply potential. The succeeding phase-inverter stage then operates with conventional values of cathode and plate resistor (same value of resistance) in its normal manner. This type of phase inverter is described in more detail in the section to follow.

4-4 Phase Inverters

It is necessary in order to excite the grids of a push-pull stage that voltages equal in amplitude and opposite in polarity be applied to the two grids. These voltages may be obtained through the use of a push-pull input transformer such as is shown in Figure 6C. It is possible also, without the attendant bulk and expense of a push-pull input transformer, to obtain voltages of the proper polarity and phase through the use of a so-called *phase-inverter* stage. There are a large number of phase inversion circuits which have been developed and applied but the three shown in Figure 8 have been found over a period of time to be the most satisfactory from the point of view of the number of components required and from the standpoint of the accuracy with which the two out-of-phase voltages are held to the same amplitude with changes in supply voltage and changes in tubes.

"Hot-Cathode" Phase Inverter Figure 8A illustrates the hot-cathode type of phase inverter. This type of phase inverter is the simplest of the three types since it requires only one tube and a minimum of circuit components. It is particularly simple when directly coupled from the plate of a pentode amplifier stage as shown in Figure 6H. The circuit does, however, possess the following two disadvantages: (1) the cathode of the tube must run at a potential of approximately 0.3 times the plate supply voltage above the heater when a grounded common heater winding is used for this tube as well as the other heater-cathode tubes in a receiver or amplifier; (2) the circuit actually has a loss in voltage from

its input to either of the output grids—about 0.9 times the input voltage will be applied to each of these grids. This does represent a voltage gain of about 1.8 in *total* voltage output with respect to input (grid-to-grid output voltage) but it is still small with respect to the other two phase inverter circuits shown.

Recommended component values for use with a 6J5 tube in this circuit are shown in Figure 8A. If it is desired to use another tube in this circuit, appropriate values for the operation of that tube as a conventional amplifier can be obtained from Table I. The value of R_L obtained from this chart should be divided by two, and this new value of resistance placed in the circuit as R_L . The value of R_k from Table I should then be used as R_{k1} in this circuit, and then the total of R_{k1} and R_{k2} should be made to equal R_L .

"Floating Paraphrase" Phase Inverter An alternate type of phase inverter sometimes called the "floating paraphrase" is illustrated in Figure 8B. This circuit is quite often used with a 6N7 tube, and appropriate values for the 6N7 tube in this application are shown. The circuit shown with the values given will give a voltage gain of approximately 21 from the input grid to each of the

grids of the succeeding stage. It is capable of approximately 80 volts output to each grid.

The circuit inherently has a small unbalance in output voltage. This unbalance can be eliminated, if it is required for some special application, by making the resistor R_{k1} a few per cent lower in resistance value than R_{k2} .

Cothode-Coupled Phase Inverter The circuit shown in Figure 8C is attaining increasing popularity due to its excellent characteristics—with regard to frequency response, distortion, and phase characteristic—and its simplicity. The circuit gives approximately one-half the voltage gain from the input grid to either of the grids of the succeeding stage that would be obtained from a single tube of the same type operating as a conventional R-C amplifier stage. Thus, with a 6SN7-GT tube as shown (two 6J5's in one envelope) the voltage gain from the input grid to either of the output grids will be approximately 7—the gain is, of course, 14 from the input to both output grids. The excellency of phase characteristics are such that the circuit is commonly used in deriving push-pull deflection voltage for a cathode-ray tube from a single-ended input signal.

AUDIO FREQUENCY POWER AMPLIFIERS

4-5 Single-Ended Triode Amplifiers

Figure 9 illustrates five circuits for the operation of Class A triode amplifier stages. Since the cathode current of a triode Class A₁ (no grid current) amplifier stage is constant with and without excitation, it is common practice to operate the tube with cathode bias. Recommended operating conditions in regard to plate voltage, grid bias, and load impedance for conventional triode amplifier stages are given in Chapters 16 and 17, Receiving Tube and Transmitting Tube Characteristics. Additional data is available in the RCA Tube Manual.

It is possible, under certain conditions, to operate single-ended triode amplifier stages (and pentode and tetrode stages as well) with grid excitation of sufficient amplitude that grid current is taken by the tube on peaks. This type of operation is called Class A₂ and is characterized by increased plate-circuit efficiency over straight Class A amplification without grid current. The normal Class A₁ amplifier power stage will operate with a plate circuit efficiency of from 20 per cent to perhaps 35 per cent. Through the use of Class A₂ operation it is possible to increase this plate circuit efficiency to approximately 38 to 45 per cent. However, such operation requires careful choice of the value of plate load impedance, a grid bias supply with good regulation (since the tube draws grid current on peaks although the plate current does not change with signal), and a driver tube with moderate power capability to excite the grid of the Class A₂ tube.

Figures 9D and 9E illustrate two methods of connection for such stages. Tubes such as the 845, 849, and 304TL (and also the 813 beam tetrode with appropriate screen supply) are suitable for such a stage. In each case the grid bias is approximately the same as would be used for a Class A₁ amplifier using the same tube, and as mentioned before, fixed bias must be used along with an audio driver of good regulation—preferably a triode stage with a 1:1 or step-down driver transformer. In each case it will be found that the correct value of plate load impedance will be increased about 40 per cent over the value recommended by the tube manufacturer for Class A₁ operation of the tube.

Both Class A₁ and Class A₂ power output, load impedance, and second harmonic distortion can be calculated with the

aid of the published average plate characteristic curves of the tube under consideration and the three equations given in Figure 10. It is simply necessary to draw a trial load line on the tube characteristics, take the values of voltage and current from the points of intersection between the load line and the tube curves, and substitute these values in the equations given. A sample calculation for a type 2A3 tube is included in Figure 10.

The correct values for R_k in Figure 9 can be obtained from the RCA Receiving Tube Handbook, or they may be obtained by dividing the value of grid bias listed for the tube and operating conditions chosen from Chapter 16 or 17 by the operating plate current of the tube. The value of C_k should be such that at the lowest audio frequency it is desired to pass with the stage the reactance of C_k is somewhat less than the resistance of R_k . Similarly, when an inductor is used for a plate feed choke as shown in Figures 9A and 9C, the reactance of L_p should be at least as great as the correct value of load resistance for the tube at the lowest audio frequency to be passed. The coupling capacitor C_c , where used, should be low with respect to R_L at the lowest frequency to be passed.

Where a transformer is employed as shown in Figure 9 to couple the energy from the plate of the output tube to the load circuit, the turns ratio of the transformer, between primary and secondary, should be equal to the square root of the impedance ratio. Thus, for example, if the recommended plate load impedance of the tube is 10,000 ohms and the load impedance to be fed is 500 ohms, the impedance ratio is 20, and the turns ratio between primary and secondary should be equal to the square root of 20 or 4.47.

4-6 Single-Ended Tetrode or Pentode Power Audio Amplifier Stages

Figure 11 illustrates the conventional circuit for a single-ended tetrode or pentode amplifier stage. Tubes of this type have largely replaced triodes in the output audio stages of receivers and low-power amplifiers due to the higher power efficiency of such stages and the greater plate circuit efficiency with which they operate. As an example, a type 45 tube operating at a plate voltage of 250 volts requires a peak grid

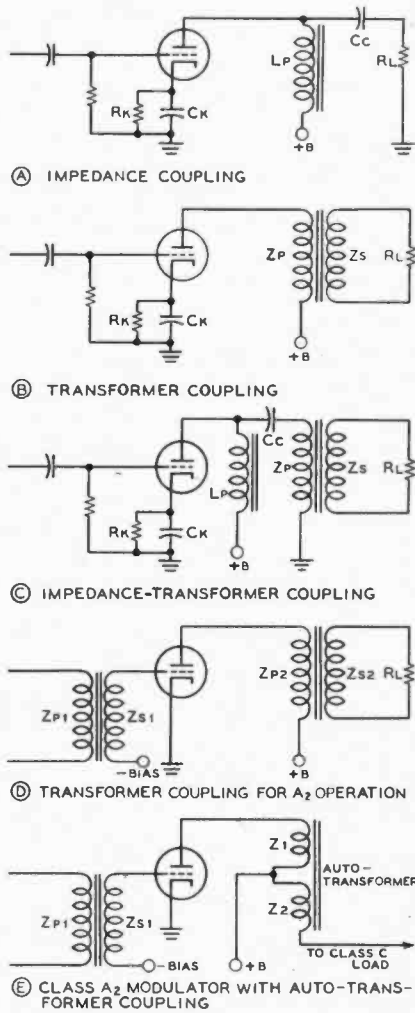

Figure 9.
Circuit Arrangements for Class A Triode Audio-Frequency Power Amplifiers.

swing of 50 volts and operates at a plate circuit efficiency of about 20 per cent, while a type 6V6 tetrode operating at the same plate and screen voltage as the type 45 requires a peak grid swing of only 12.5 volts and delivers about 35 per cent of its total input power in the form of useful output.

Tetrode and pentode tubes do, however, introduce a considerably greater amount of harmonic distortion into their output, and their plate circuit impedance (which acts in a receiver to damp loudspeaker overshoot and ringing, and acts in a driver stage to give good regulation) is many times higher than that of an equivalent triode. The application of negative feedback to an amplifier employing tetrode and pentode tubes acts both to reduce distortion and to reduce the effective plate circuit impedance of the stage. The application of negative feedback to such amplifiers is described in section 4-15 of this chapter and is illustrated in certain of the equipments described in Chapter 24.

4-7 Push-Pull Class A and Class AB Audio Amplifier Stages

A number of advantages are obtained through the use of the push-pull connection of two or four tubes in an audio-frequency power amplifier. Several conventional circuits for the use of triode and tetrode tubes in the push-pull connection are shown in Figure 12. The two main advantages of the push-pull circuit arrangement are: (1) the magnetizing effect of the

ZERO SIGNAL BIAS

$$E_c = - \frac{0.68 E_b}{\mu} \text{ VOLTS}$$

LOAD RESISTANCE

$$R_L = \frac{E_{MAX} - E_{MIN}}{I_{MAX} - I_{MIN}} \text{ OHMS}$$

POWER OUTPUT

$$P_o = \frac{(I_{MAX} - I_{MIN})(E_{MAX} - E_{MIN})}{8} \text{ WATTS}$$

SECOND HARMONIC DISTORTION

$$D_2 = \frac{\left(\frac{I_{MAX} + I_{MIN}}{2} - I_o\right)}{I_{MAX} - I_{MIN}} \times 100 \text{ PERCENT}$$

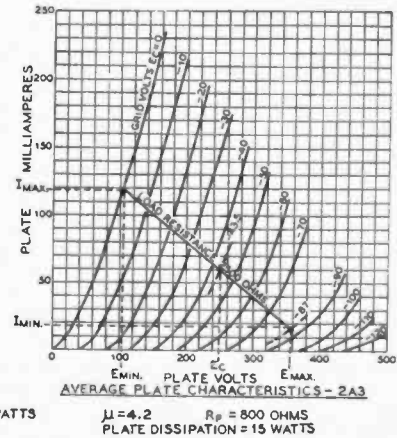

Figure 10.
Formulas for Determining the operating conditions for a Class A Triode Power Amplifier Stage. A Typical Load Line Has Been Drawn on the Average Plate Characteristics of a Type 2A3 Tube to Illustrate The Procedure.

plate currents of the output tubes is cancelled in the windings of the output transformer; (2) even harmonics of the input signal (second and fourth harmonics primarily) generated in the push-pull stage are cancelled when the tubes are balanced.

The cancellation of even harmonics generated in the stage allows the tubes to be operated Class AB—in other words the tubes may be operated with bias and input signals of such amplitude that the plate current of alternate tubes may be cut off during a portion of the input voltage cycle. If a tube were operated in such a manner in a single-ended amplifier the second harmonic amplitude generated would be prohibitively high. Push-pull Class AB operation allows a plate circuit efficiency of from 45 to 60 per cent to be obtained in an amplifier stage depending upon whether or not the exciting voltage is of such amplitude that grid current is drawn by the tubes. If grid current is taken on input voltage peaks the amplifier is said to be operating Class AB₂ and the plate circuit efficiency can be as high as the upper value just mentioned. If grid current is not taken by the stage it is said to be operating Class AB₁ and the plate circuit efficiency will be toward the lower end of the range just quoted. In all Class AB amplifiers the plate current will increase from 40 to 150 per cent over the no-signal value when full signal is applied. Recommended Class AB operating conditions for selected tubes are given in Chapter 16.

4-8 Class B Audio-Frequency Power Amplifiers

The Class B audio-frequency power amplifier operates at a higher plate-circuit efficiency than any of the previously described types of audio power amplifiers. Full-signal plate-circuit efficiencies of 60 to 70 per cent are readily obtainable with the tube types at present available for this type of work. Since the plate circuit efficiency is higher, smaller tubes of lower plate dissipation may be used in a Class B power ampli-

Figure 11.
Pentode or Tetrode A-F Power Amplifier Circuit.

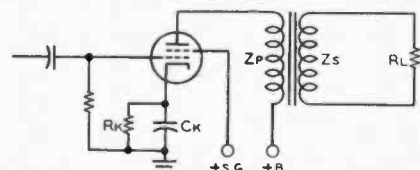

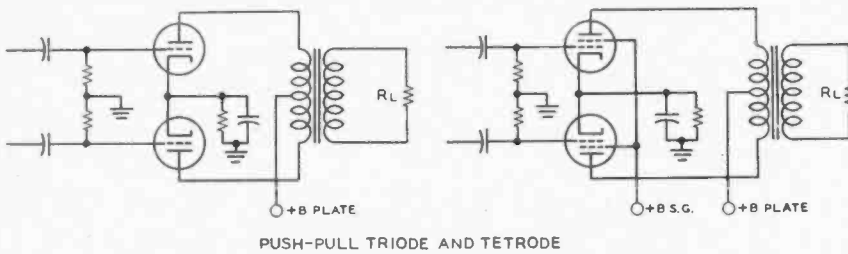

Figure 12.

fier of a given power output than can be used in any other conventional type of audio amplifier. An additional factor in favor of the Class B audio amplifier is the fact that the power input to the stage is relatively low under no-signal conditions. It is for these reasons that this type of amplifier has largely superseded other types in the generation of audio-frequency power levels from perhaps 100 watts on up to levels of approximately 150,000 watts as required for large short-wave broadcast stations.

There are attendant disadvantageous features to the operation of a power amplifier of this type; but all these disadvantages can be overcome by proper design of the circuits associated with the power amplifier stage. These disadvantages are: (1) The Class B audio amplifier requires driving power in its grid circuit; this disadvantage can be overcome by the use of an oversize power stage preceding the Class B stage with a step-down transformer between the driver stage and the Class-B grids. Degenerative feedback is sometimes employed to reduce the plate impedance of the driver stage and thus to improve the voltage regulation under the varying load presented by the Class B grids. (2) The Class B stage requires a constant value of average grid bias to be supplied in spite of the fact that the grid current on the stage is zero over most of the cycle but rises to values as high as one third of the peak plate current on the peak of the exciting voltage cycle. Special regulated bias supplies have been used for this application, or B batteries can be used. However, a number of tubes especially designed for Class B audio amplifiers have been developed which require zero average grid bias for their operation. The 811, 838, 805, 203Z, 809, HY-5514, and TZ-40 are examples of this type of tube. All these so-called "zero-bias" tubes have rated operating conditions up to moderate plate voltages wherein they can be operated without grid bias. As the plate voltage is increased to their maximum ratings, however, a small amount of grid bias such as could be obtained from several $4\frac{1}{2}$ -volt C batteries is required.

And (3), a Class B audio-frequency power amplifier or modulator requires a source of plate supply voltage having reasonably good regulation. This requirement led to the development of the "swinging choke". The swinging choke is essentially a conventional filter choke in which the core air gap has been reduced. This reduction in the air gap allows the choke to have a much greater value of inductance with low current values such as are encountered with no signal or small signal being applied to the Class B stage. With a higher value of

current such as would be taken by a Class B stage with full signal applied the inductance of the choke drops to a much lower value. With a swinging choke of this type, having adequate current rating, as the input inductor in the filter system for a rectifier power supply, the regulation will be improved to a point which is normally adequate for a power supply for a Class B amplifier or modulator stage. Swinging-choke power supplies are discussed in detail in Chapter 25.

Recommended Operating Conditions

Table III lists recommended operating conditions for a number of tube types that find frequent application as Class B a-f power amplifiers and modulators. Certain additional operating conditions are also given for other tube types as Class AB₁ and Class AB₂ power amplifiers and modulators.

It is often desirable to operate a pair of tubes as a Class B power amplifier at plate voltages somewhat different from the conditions listed in Table III or given as standard by the vacuum-tube manufacturers. The procedure given in the following paragraphs can be used to determine proper operating conditions for non-standard applications.

Calculation of Operating Conditions of Class-B Power Amplifiers

The following procedure can be used for the calculation of the operating conditions of Class B power amplifiers when they are to operate into a resistive load such as the type of load presented by a Class C power amplifier. This procedure will be found quite satisfactory for the application of vacuum tubes as Class B modulators when it is desired to operate the tubes under conditions which are not specified in the tube operating characteristics published by the tube manufacturer. The same procedure can be used with equal effectiveness for the calculation of the operating conditions of beam tetrodes as Class AB₂ amplifiers or modulators when the resting plate current on the tubes (no signal condition) is less than 25 or 30 per cent of the maximum-signal plate current.

First, with the average plate characteristics of the tube as published by the manufacturer before you, select a point on the E_c-E_b (diode bend) line at about twice the plate current you expect the tubes to kick to under modulation. If beam tetrode tubes are concerned, select a point at about the same amount of plate current mentioned above, just to the right of the region where the I_b line takes a sharp curve downward. This will be the first trial point, and the plate voltage at the point chosen should be not more than about 20 per cent of the d-c voltage applied to the tubes if good plate-circuit efficiency is desired.

Second, note down the value of i_{pmax} and e_{pmin} at this point.

Third, subtract the value of e_{pmin} from the d-c plate voltage on the tubes.

Fourth, substitute the values obtained in the following equations:

$$P_o = \frac{i_{pmax} (E_{bb} - e_{pmin})}{2} = \text{Power output from 2 tubes}$$

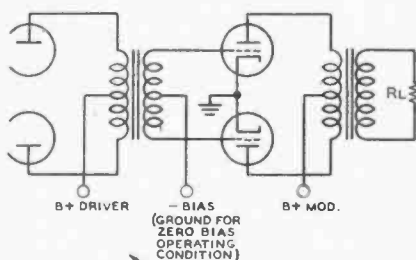

Figure 13.
Class B Audio-Frequency Power Amplifier.

TABLE III
CLASS AB₂ AND CLASS B AUDIO-FREQUENCY POWER AMPLIFIERS

TUBES (2)	PLATE VOLTAGE	GRID BIAS	FILAMENT VOLTAGE	PEAK A.F. GRID TO GRID	ZERO SIGNAL PLATE CURRENT	MAX. SIGNAL PLATE CURRENT	LOAD RESISTANCE	MAX. SIGNAL DRIVING POWER	RECOMMENDED DRIVER	PEAK POWER OUTPUT	AVERAGE SINE-WAVE POWER OUTPUT
2E30	180 EP 180 ESG	-22.5	6.0	75	16	100	2500	0.23	SINGLE 2E30	14.8	7.4
	250 EP 250 ESG	-30	6.0	87	40	120	3800	0.2	SINGLE 2E30	34	17
	285 EP 285 ESG	-19	6.3	3A	70	92	9000	NO GRID CUR.	SINGLE 6J5	28	14
6V6 (AB ₁)	350 EP 250 ESG	340 Ω RESISTOR	6.3	94	54	77	10000	0.2	SINGLE 6J5	38	19
	360 EP 270 ESG		6.3	57	88	100	9000	NO GRID CUR.	SINGLE 6J5	49	24.5
6L6 (AB ₂)	360 EP 270 ESG	-1P	6.3	52	78	142	8000	0.140	SINGLE 6J5	82	31
	360 EP 270 ESG		-22.5	6.3	72	88	208	3800	0.270	6SN7	94
2E26 (PAIR)	400 EP 125 ESG	-15	6.3 OR 12.6	60	20	150	8200	0.36	6SN7	84	42
815 (SINGLE)	500 EP 125 ESG	-15	6.3 OR 12.6	60	22	130	8000	0.36	6SN7	104	54
	500 EP 300 ESG	-25	6.3	78	100	240	4240	0.2	6SN7	150	75
	600 EP 300 ESG	30	6.3	78	60	208	6400	0.1	6SN7	160	80
807	750 EP 300 ESG	-32	6.3	92	60	240	6950	0.2	6SN7	240	120
	600 EP 300 ESG	-35	6.0	100	50	200	6500	0.3	6SN7	160	80
HY-69	700	0	6.3	160	70	250	6200	3.4	6L6 WITH FEEDBACK	240	120
	1000	-9	6.3	155	40	200	11800	2.7	6L6 WITH FEEDBACK	290	145
811	1000	0	6.3	160	30	260	8600	4.0	6L6 WITH FEEDBACK	370	185
	1250	0	6.3	150	48	240	12000	3.4	6L6 WITH FEEDBACK	420	210
	1500	-9	6.3	150	20	200	17600	3.0	6L6 WITH FEEDBACK	440	220
35T	1000	-8	5.0	240	67	240	7900	7.0	PUSH-PULL 2A3'S CLASS AB ₁	280	140
	1500	-25	5.0	250	45	200	16200	5.0	PUSH-PULL 2A3'S CLASS AB ₁	400	200
	2000	-40	5.0	255	34	167	27500	4.0	6L6 WITH FEEDBACK	470	235
203A	1000	-35	10.0	310	28	320	6900	10.0	2A3'S CLASS AB ₁	400	200
	1250	-45	10.0	330	26	320	9000	11.0	2A3'S CLASS AB ₁	520	260
211	1000	-77	10.0	380	20	320	6900	7.5	2A3'S CLASS AB ₁	400	200
	1280	-100	10.0	410	20	320	9000	8.0	2A3'S CLASS AB ₁	520	260
838	1000	0	10.0	200	106	320	6900	7.0	2A3'S CLASS AB ₁	400	200
	1280	0	10.0	200	148	320	9000	7.5	2A3'S CLASS AB ₁	520	260
5514	750	0	7.5	93	46	200	8400	3.0	6L6 WITH FEEDBACK	210	105
	1250	0	7.5	118	84	300	10000	4.5	6L6 WITH FEEDBACK	340	270
	1500	-4.5	7.5	146	50	350	10500	8.5	2A3'S CLASS AB ₁	800	400
8005	1000	-55	10.0	290	40	320	8000	4.0	6L6 WITH FEEDBACK	500	250
	1250	-7P	10.0	310	40	310	10000	4.0	6L6 WITH FEEDBACK	600	300
828	EP=1700 ESG=750 ESup=60	-120	10.0	240	50	248	16200	NO GRID CUR.	6J5 OR 6SJ7'S	600	300
	EP=2000 ESG=750 ESup=60	-120	10.0	240	50	270	18500	NO GRID CUR.	6J5 OR 6SJ7'S	730	365
75TL	1500	-105	5.0	450	67	285	11000	6.0	2A3'S CLASS AB ₁	560	280
	2000	-160	5.0	534	50	250	18000	5.0	2A3'S CLASS A	750	350
100TH	2000	-35	5.0	310	60	280	15000	7.0	2A3'S CLASS AB ₁	720	360
	3000	-65	5.0	335	40	215	31000	5.0	2A3'S CLASS A	900	450
	EP=2000 ESG=800	-94	5.0	188	50	240	13400	NO GRID CUR.	6SN7 OR 6SJ7'S	460	230
4-125A (AB ₁)	EP=2500 ESG=800	-96	5.0	192	50	232	20300	NO GRID CUR.	6SN7 OR 6SJ7'S	660	330
	EP=2000 ESG=350	-45	5.0	210	72	300	13800	3.1	6L6 WITH FEEDBACK	700	350
	EP=3000 ESG=350	-51	5.0	198	55	260	27700	2.5	6L6 WITH FEEDBACK	1040	520
8003	1350	-100	10.0	460	40	490	6000	10.8	2A3'S CLASS AB ₁	920	460
813	EP=2250 ESG=750	-90	10.0	230	45	315	16500	0.1	6SN7	1030	515
	EP=2500 ESG=750	-95	10.0	235	35	360	17000	0.35	6V6 WITH FEEDBACK	1300	650
810	2000	-30	16.0	345	60	420	11000	10.0	2A3'S CLASS AB ₁	1180	590
	2250	-80	10.0	380	70	450	11600	13.0	4- 2A3'S CLASS AB ₁	1450	725
4-250A (AB ₁)	EP=2000 ESG=500	-88	5.0	176	110	405	9170	NO GRID CUR.	6SN7 OR 6SJ7'S	920	460
	EP=3000 ESG=500	-95	5.0	186	120	417	15000	NO GRID CUR.	6SN7 OR 6SJ7'S	1500	750
	EP=2000 ESG=300	-46	5.0	198	120	510	8000	2.3	6L6 WITH FEEDBACK	1300	650
304TL (B)	EP=3000 ESG=300	-53	5.0	198	125	473	16000	1.9	6L6 WITH FEEDBACK	2060	1040
	2000	-160	5.0 OR 10.0	320	200	546	5300	NO GRID CUR.	6SN7 OR 6SJ7'S	980	490
304TL (A)	3000	-280	5.0 OR 10.0	520	130	444	12000	NO GRID CUR.	6SN7 OR 6SJ7'S	1460	730
	1500	-105	5.0 OR 10.0	500	270	1.14 AMP.	2750	30	845'S CLASS A	2200	1100
	2000	-160	5.0 OR 10.0	580	200	1.0 AMP.	4500	25	845'S CLASS A	2800	1400

$$R_L = 4 \frac{(E_{hb} - e_{pmin})}{i_{pmax}} = \text{Plate-to-plate load for 2 tubes}$$

$$N_p = 78.5 \left(1 - \frac{e_{pmin}}{E_{bb}} \right) = \text{Full signal plate efficiency}$$

All the above equations are true for sine-wave operating conditions on the tubes concerned. However, if a clipper or other limiter system is being used in the speech amplifier, or if it is desired to calculate the operating conditions on the basis of the fact that the ratio of peak power to average power in a speech wave is approximately 4-to-1 as contrasted to the ratio of 2-to-1 in a sine wave—in other words, when non-sinusoidal waves such as plain speech or speech that has passed

through a clipper are concerned, we are no longer concerned with average power output of the modulator as far as its capability of modulating a class-C amplifier is concerned, we are concerned with its peak-power-output capability.

Under these conditions we call upon other, more general relationships. The first of these is: It requires a peak power output equal to the Class-C stage input to modulate that input fully.

The second one is: The average power output required of the modulator is equal to the shape factor of the modulating wave multiplied by the input to the Class-C stage. The shape factor of unclipped speech is approximately 0.25. The shape factor of a sine wave is 0.5. The shape factor of a speech wave that has been passed through a clipper or other clipper-filter

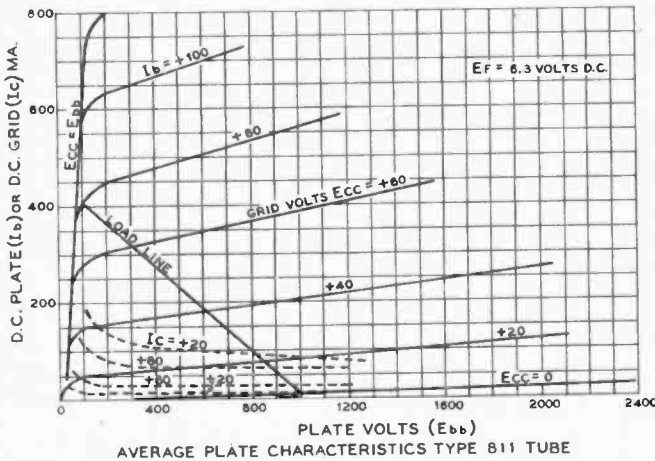

Figure 14.

Typical Class B A-F Amplifier Load Line. The load line has been drawn on the average plate characteristics of a type 811 tube. See Figure 15 for the method of calculation of operating conditions.

arrangement is somewhere between 0.25 and 0.9 depending upon the amount of clipping that has taken place. With 15 or 20 db of clipping the shape factor may be as high as the figure of 0.9 mentioned above. This means that the audio power output of the modulator will be 90% of the input to the Class C stage. Thus with a kilowatt input we would be putting 900 watts of audio into the Class-C stage for 100 per cent modulation as contrasted to perhaps 250 watts for unclipped speech modulation of 100 per cent. It is easy to see that the signal of the station using the clipper will appear to be modulated much more effectively, yet there will be none of the ill effects of overmodulation.

Sample Calculation for 811 Tubes Figure 14 shows a set of plate characteristics for a type 811 tube with a load line for Class B operation. Figure 15 lists a sample calculation for determining the proper operating conditions for obtaining approximately 185 watts output from a pair of the tubes with 1000 volts d-c plate potential. Also shown on Figure 15 is the method of determining the proper ratio for the modulation transformer to couple between the 811's and the anticipated final amplifier which is to operate at 2000 plate volts and 175 ma. plate current.

Modulation Transformer Calculation The method illustrated in Figure 15 can be used in general for the determination of the proper transformer ratio to couple between the modulator tube and the amplifier to be modulated. The procedure can be stated as follows: (1) Determine the proper plate-to-plate load impedance for the modulator tubes either by use of the type of calculation shown in Figure 15, by reference to Table III, or by reference to the published characteristics on the tubes to be used. (2) Determine the load impedance which will be presented by the Class C amplifier stage to be modulated by dividing the operating plate voltage on that stage by the operating value of plate current in amperes. (3) Divide the Class C load impedance determined in (2) above by the plate-to-plate load impedance for the modulator tubes determined in (1) above. The ratio determined in this way is the secondary-to-primary impedance ratio. (4) Take the square root of this ratio to determine the secondary-to-primary turns ratio. If the turns ratio is greater than one the use of a step-up transformer is required. If the turns ratio as determined in this way is less than one a step-down transformer is called for.

SAMPLE CALCULATION

CONDITION: 2 TYPE 811 TUBES, $E_{bb} = 1000$
 INPUT TO FINAL STAGE, 350 W.
 PEAK POWER OUTPUT NEEDED = $350 + 8\% = 370$ W
 FINAL AMPLIFIER $E_{bb} = 2000$ V.
 FINAL AMPLIFIER $I_b = .175$ A.
 FINAL AMPLIFIER $Z_L = \frac{2000}{.175} = 11400 \Omega$

EXAMPLE: CHOSE POINT ON 811 CHARACTERISTICS JUST TO RIGHT OF $E_{bb} = E_{cc}$.

I_P MAX. = .410 A. E_P MIN. = +100
 I_G MAX. = .100 A. E_G MAX. = +80

PEAK $P_D = .410 \times (1000 - 100) = .410 \times 900 = 369$ W.

$R_L = 4 \times \frac{900}{.410} = 8800 \Omega$

$N_P = 78.5 (1 - \frac{100}{1000}) = 78.5 (.9) = 70.5 \%$

W_O (AVERAGE WITH SINE WAVE) = $\frac{P_O(PEAK)}{2} = 184.5$ W

$W_{IN} = \frac{184.5}{70.5} = 260$ W.

I_b (MAXIMUM WITH SINE WAVE) = 280 MA

W_G PEAK = $.100 \times 80 = 8$ W.

DRIVING POWER = $\frac{W_G PK}{2} = 4$ W.

TRANSFORMER:

$\frac{Z_S}{Z_P} = \frac{11400}{8800} = 1.29$

URNS RATIO = $\sqrt{\frac{Z_S}{Z_P}} = \sqrt{1.29} = 1.14$ STEP UP

Figure 15.

Typical calculation of operating conditions for a Class B a-f power amplifier using a pair of type 811 tubes. Plate characteristics and load line shown in Figure 14.

If the procedure shown in Figure 15 has been used to calculate the operating conditions for the modulator tubes, the transformer ratio calculation can be checked in the following manner: Divide the plate voltage on the modulated amplifier by the total voltage swing on the modulator tubes—2 ($E_{bb} - e_{min}$). This ratio should be quite close numerically to the transformer turns ratio as previously determined. The reason for this condition is quite obvious; the ratio between the total primary voltage and the d-c plate supply voltage on the modulated stage is equal to the turns ratio of the transformer since a peak secondary voltage equal to the plate voltage on the modulated stage is required to modulate this stage 100 per cent.

Note Concerning Use of Clipper Speech Amplifier with Tetrode Modulator Tubes When a clipper speech amplifier is used in conjunction with a Class B modulator stage, the plate current on that stage will kick to a higher value with modulation (due to the greater average power output and input) but the plate dissipation on the tubes will ordinarily be less than with sine-wave modulation. However, when tetrode tubes are used as modulators, the screen dissipation will be much greater than with sine-wave modulation. Care must be taken to insure that the screen dissipation rating on the modulator tubes is not exceeded under full modulation conditions with a clipper speech amplifier. The screen dissipation is equal to screen voltage times screen current.

4-9 Cathode-Follower Power Amplifiers

The cathode-follower amplifier was mentioned briefly at the beginning of this chapter under "Classes and Types of Amplifiers". The cathode-follower is essentially a power output stage in which the exciting signal is applied between grid and ground, the plate is maintained at ground potential with respect to input and output signals, and the output signal is taken between cathode and ground. Figure 16 illustrates four types of cathode-follower power amplifiers in common usage and Figure 17 shows the output impedance (R_o), and stage gain (A) of both triode and pentode (or tetrode) cathode-follower stages. It will be seen by inspection of the equations that the stage voltage gain is always less than one, that the output impedance of the stage is much less than the same stage oper-

ated as a conventional cathode-return amplifier. The output impedance for conventional tubes will be somewhere between 100 and 1000 ohms, depending primarily on the transconductance of the tube.

This reduction in gain and output impedance for the cathode-follower comes about since the stage operates as though it had 100 per cent degenerative feedback applied between its output and input circuit. Even though the voltage gain of the stage is reduced to a value less than one by the action of the degenerative feedback, the power gain of the stage if it is operating Class A is not reduced. Although more voltage is required to excite a cathode-follower amplifier than appears across the load circuit, since the cathode "follows" along with the grid the relative grid-to-cathode voltage is essentially the same as in a conventional amplifier.

Although the cathode-follower gives no voltage gain, it is an effective power amplifier where it is desired to feed a low-impedance load, or where it is desired to feed a load of varying impedance with a signal having good regulation. This latter capability makes the cathode follower particularly effective as a driver for the grids of a Class B modulator stage. An example of this application is shown in the push-pull 807 modulator described in Chapter 26.

The circuit of Figure 16A is the type of amplifier, either single-ended or push-pull, which may be used as a driver for a Class B modulator or which may be used for other applications such as feeding a loudspeaker where unusually good

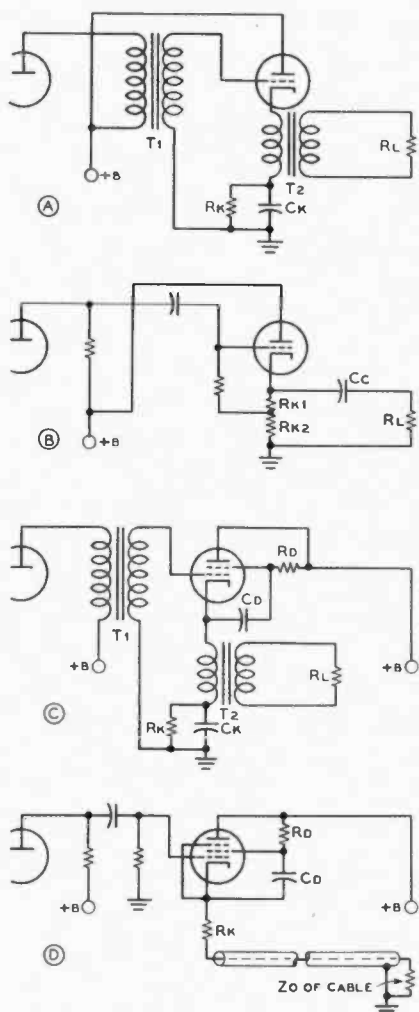

Figure 16. Cathode Follower Output Circuits for Audio or Video Amplifiers. See Text for Description.

TRIODE: $\mu_{CF} = \frac{\mu}{\mu + 1}$ $A = \frac{\mu R_L}{R_L(\mu + 1) + R_p}$

$R_{O(CATHODE)} = \frac{R_p}{\mu + 1}$ $R_L = \frac{(R_{K1} + R_{K2}) R_L'}{R_{K1} + R_{K2} + R_L'}$

PENTODE: $R_{O(CATHODE)} = \frac{1}{G_M}$ $R_{EQ} = \frac{R_L}{1 + R_L G_M}$

$A = G_M R_{EQ}$

Figure 17.

Equivalent Factors for Triode and Pentode (or Tetrode) Cathode-Follower Power Amplifiers.

damping of the speaker is desired. If the d-c resistance of the primary of the transformer T_2 is approximately the correct value for the cathode bias resistor for the amplifier tube, the components R_k and C_k need not be used. Figure 16B shows an arrangement which may be used to feed directly a value of load impedance which is equal to or higher than the cathode impedance of the amplifier tube. The value of C_c must be quite high, somewhat higher than would be used in a conventional circuit, if the frequency response of the circuit when operating into a low-impedance load is to be preserved.

Figures 16C and 16D show cathode-follower circuits for use with tetrode or pentode tubes. Figure 16C is a circuit similar to that shown in 16A and essentially the same comments apply in regard to the components R_k and C_k and the primary resistance of the transformer T_2 . Notice also that the screen of the tube is maintained at the same signal potential as the cathode by means of coupling capacitor C_s . This capacitance should be large enough so that at the lowest frequency it is desired to pass through the stage its reactance will be low with respect to the dynamic screen-to-cathode resistance in parallel with R_k . T_2 in this stage as well as in the circuit of Figure 16A should have the proper turns (or impedance) ratio to give the desired step-down or step-up from the cathode circuit to the load. Figure 16D is an arrangement frequently used in video systems for feeding a coaxial cable of relatively low impedance from a vacuum-tube amplifier. A pentode or tetrode tube with a cathode impedance as a cathode follower ($1/G_m$) approximately the same as the cable impedance should be chosen. The 6AG7 and 6AC7 have cathode impedances of the same order as the surge impedances of certain types of low-capacitance coaxial cable. An arrangement such as 16D is also usable for feeding coaxial cable with audio or r-f energy where it is desired to transmit the output signal over moderate distances. The resistor R_k is added to the circuit as shown if the cathode impedance of the tube used is higher than the characteristic impedance of the cable. If the output impedance of the stage is lower than the cable impedance a resistance of appropriate value is sometimes placed in parallel with the input end of the cable. The values of C_c and R_d should be chosen with the same considerations in mind as mentioned in the discussion of the circuit of Figure 16C above.

The cathode follower may conveniently be used as a method of coupling r-f or i-f energy between two units separated a considerable distance. In such an application a coaxial cable should be used to carry the r-f or i-f energy. One such application would be for carrying the output of a v-f-o to a transmitter located a considerable distance from the operating position. Another application would be where it is desired to feed a single-sideband demodulator, an FM adaptor, or another accessory with intermediate-frequency signal from a communications receiver. A tube such as a 6SH7 connected in a manner such as is shown in Figure 16D would be adequate for the i-f amplifier coupler, while a 6L6 or a 6AG7 could be used in the output stage of a v-f-o as a cathode follower to feed the coaxial line to the transmitter.

TUNED R-F VOLTAGE AMPLIFIERS

Tuned r-f voltage amplifiers are used in receivers for the amplification of the incoming r-f signal and for the amplification of intermediate frequency signals after the incoming frequency has been converted to the intermediate frequency by the mixer stage. Signal frequency stages are normally called tuned r-f amplifiers and intermediate-frequency stages are called i-f amplifiers. Both tuned r-f and i-f amplifiers are operated Class A and normally operate at signal levels from a fraction of a microvolt to amplitudes as high as 10 to 50 volts at the plate of the last i-f stage in a receiver.

4-10 Grid-Circuit Considerations

Since the full amplification of a receiver follows the first tuned circuit, the operating conditions existing in that circuit and in its coupling to the antenna on one side and to the grid of the first amplifier stage on the other are of greatest importance in determining the signal-to-noise ratio of the receiver on weak signals.

First Tuned Circuit It is obviously of great importance that the highest ratio of signal-to-noise be impressed on the grid of the first r-f amplifier tube. Attaining the optimum ratio is a complex problem since noise will be generated in the antenna due to its equivalent radiation resistance (this noise is in addition to any noise of atmospheric origin) and in the first tuned circuit due to its equivalent coupled resistance at resonance. The noise voltage generated due to antenna radiation resistance and to equivalent tuned circuit resistance is similar to that generated in a resistor due to thermal agitation and is expressed by the following equation:

$$E_n^2 = 4kTR\Delta f$$

- Where: E_n = r-m-s value of noise voltage over the interval Δf
 k = Boltzmann's constant = 1.374×10^{-23} joule per °K.
 T = Absolute temperature °K.
 R = Resistive component of impedance across which thermal noise is developed.
 Δf = Frequency band across which voltage is measured.

In the above equation Δf is essentially the frequency band

passed by the intermediate frequency amplifier of the receiver under consideration. This equation can be greatly simplified for the conditions normally encountered in communications work. If we assume the following conditions: $T = 300^\circ \text{K}$ or 27°C or 80.5°F , room temperature; $\Delta f = 8000$ cycles (the average pass band of a communications receiver or speech amplifier), the equation reduces to: $E_{r.m.s.} = 0.0115\sqrt{R}$ microvolts. Accordingly, the thermal-agitation voltage appearing in the center of half-wave antenna (assuming effective temperature to be 300°K) having a radiation resistance of 73 ohms is approximately 0.096 microvolts. Also, the thermal agitation voltage appearing across a 500,000-ohm grid resistor in the first stage of a speech amplifier is approximately 8 microvolts under the conditions cited above. Further, the voltage due to thermal agitation being impressed on the grid of the first r-f stage in a receiver by a first tuned circuit whose resonant resistance is 50,000 ohms is approximately 2.5 microvolts. Suffice to say, however, that the value of thermal agitation voltage appearing across the first tuned circuit when the antenna is properly coupled to this circuit will be very much less than this value.

It is common practice to match the impedance of the antenna transmission line to the input impedance of the grid of the first r-f amplifier stage in a receiver. This is the condition of antenna coupling which gives maximum gain in the receiver. However, when u-h-f tubes such as acorns and miniatures are used at frequencies somewhat less than their maximum capabilities, a significant improvement in *signal-to-noise* ratio can be attained by increasing the coupling between the antenna and first tuned circuit to a value greater than that which gives greatest signal amplitude out of the receiver. In other words, in the 10, 6, and 2 meter bands it is possible to attain somewhat improved signal-to-noise ratio by increasing antenna coupling to the point where the gain of the receiver is slightly reduced.

It is always possible, in addition, to obtain improved signal-to-noise ratio in a v-h-f receiver through the use of tubes which have improved input impedance characteristics at the frequency in question over conventional types.

Noise Factor The limiting condition for sensitivity in any receiver is the thermal noise generated in the antenna and in the first tuned circuit. However, with proper

TABLE IV
INPUT CAPACITANCE, CONDUCTANCE, AND RELATIVE FIGURE OF MERIT OF TUBES AT 100 MC.

		SINGLE-ENDED METAL TYPES						MINIATURE TYPES					
		6SJ7	6SK7	6SH7	6SG7	6AB7	6AC7	9001	9003	6AU6	6BA6	6AG5	6AK5
1. PLATE VOLTAGE	VOLTS	250	250	250	250	300	300	250	250	250	250	250	120
2. SCREEN VOLTAGE	VOLTS	100	100	150	125	200	150	100	100	150	100	150	120
3. GRID VOLTAGE	VOLTS	-3.2	-2.6	-1.0	-1.0	-2.6	-2.2	-2.9	-2.9	-1.2	-1.3	-1.8	-2.0
4. PLATE CURRENT	MA.	3.0	9.2	12.2	11.6	12.5	10.0	2.0	6.7	10.6	11.0	7.4	7.5
5. SCREEN CURRENT	MA.	0.9	2.7	4.2	4.5	3.1	2.4	0.8	2.5	4.4	4.4	2.4	2.5
6. TRANSCONDUCTANCE	MMHOS	1490	1980	5500	4950	4700	9450	1450	1900	5250	4300	4950	4950
SHORT-CIRCUIT INPUT CAPACITANCE = C_i :													
7. TUBE OPERATING AS IN LINES 1 TO 6	MMUF	9.5	9.4	13.9	13.6	12.4	16.0	5.5	5.0	10.0	9.6	9.3	6.4
SHORT-CIRCUIT INPUT CONDUCTANCE = G_i :													
8. TUBE OPERATING AS IN LINES 1 TO 6	MMHOS	526	503	632	604	792	1970	61.7	66	759	603	326	134
9. SOCKET CAPACITANCE	MMUF			1.6							0.6		
10. SOCKET CONDUCTANCE	MMHOS			26.6							2.3		
11. GRID TO CATHODE CAPACITANCE (MEASURED WITH TUBES COLD AT LOW FREQUENCY)	MMUF		2.01	3.59	3.42	3.15	5.26	1.64	1.31	3.10	3.02	3.35	2.31
12. FIGURE OF MERIT	$\frac{G_m}{\sqrt{C_i}}$	65	66	220	200	166	212	196	234	190	175	273	425

coupling between the antenna and the grid of the tube, through the first tuned circuit, the noise contribution of the first tuned circuit can be made quite small. Unfortunately, though, the major noise contribution in a properly designed receiver is that of the first tube. The noise contribution due to electron flow and due to losses in the tube can be lumped into an equivalent value of resistance which, if placed in the grid circuit of a perfect tube having the same gain but no noise would give the same noise voltage output in the plate load. The equivalent noise resistance of tubes such as the 6SK7, 6SG7, etc., runs from 5000 to 10,000 ohms. Very high G_m tubes such as the 6AC7 and 6AK5 have equivalent noise resistances as low as 700 to 1500 ohms. The lower the value of equivalent noise resistance, the lower will be the noise output under a fixed set of conditions.

The equivalent noise resistance of a tube must not be confused with the actual input loading resistance of a tube. For highest signal-to-noise ratio in an amplifier the input loading resistance should be as high as possible so that the amount of voltage that can be developed from grid to ground by the antenna energy will be as high as possible, the equivalent noise resistance should be as low as possible so that the noise generated by this resistance will be lower than that attributable to the antenna and first tuned circuit, and the losses in the first tuned circuit should be as low as possible.

The absolute sensitivity of receivers has been designated in recent years in government and commercial work by an arbitrary dimensionless number known as "noise factor" or N . The noise factor is the ratio of noise output of a "perfect" receiver having a given amount of gain with a dummy antenna matched to its input, to the noise output of the receiver under measurement having the same amount of gain with the dummy antenna matched to its input. Although a perfect receiver is not a physically realizable thing, the noise factor of a receiver under measurement can be determined by calculation from the amount of additional noise (from a temperature-limited diode or other calibrated noise generator) required to increase the noise power output of a receiver by a predetermined amount.

Tube Input Loading As has been mentioned in a previous paragraph, greatest gain in a receiver is obtained when the antenna is matched, through the r-f coupling transformer, to the input resistance of the r-f tube. However, the higher the ratio of tube input resistance to equivalent noise resistance of the tube the higher will be the signal-to-noise ratio of the stage—and of course, the better will be the noise factor of the overall receiver. The input resistance of a tube is very high at frequencies in the broadcast band and gradually decreases as the frequency increases. Tube input resistance on conventional tube types begins to become an important factor at frequencies of about 25 Mc. and above. At frequencies above about 100 Mc. the use of conventional tube types becomes impracticable since the input resistance of the tube has become so much lower than the equivalent noise resistance that it is impossible to attain reasonable signal-to-noise ratio on any but very strong signals. Hence, special u-h-f tube types must be used.

The lowering of the effective input resistance of a vacuum tube at higher frequencies is brought about by a number of factors. The first, and most obvious, is the fact that the dielectric loss in the internal insulators, and in the base and press of the tube increases with frequency. The second factor is due to the fact that a finite time is required for an electron to move from the space charge in the vicinity of the cathode, pass between the grid wires, and travel on to the plate. The fact that the electrostatic effect of the grid on the moving electron acts over an appreciable portion of a cycle at these high frequencies causes a current flow in the grid circuit which appears

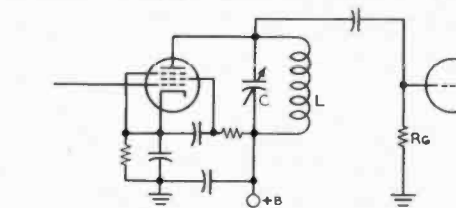

(A) AMPLIFICATION AT RESONANCE (APPROX.) = $G_m \omega L Q$

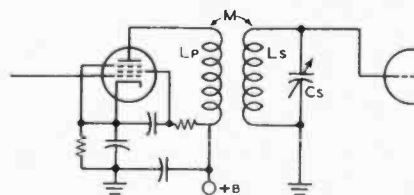

(B) AMPLIFICATION AT RESONANCE (APPROX.) = $G_m \omega M Q$

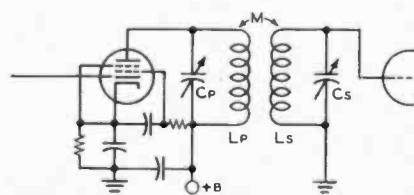

(C) AMPLIFICATION AT RESONANCE (APPROX.) = $G_m K \frac{\omega L_p L_s}{K^2 + 1} \frac{1}{Q_p Q_s}$

WHERE: 1. PRI. AND SEC. RESONANT AT SAME FREQUENCY
2. K IS COEFFICIENT OF COUPLING

IF PRI. AND SEC. Q ARE APPROXIMATELY THE SAME:
 $\frac{\text{TOTAL BANDWIDTH}}{\text{CENTER FREQUENCY}} = 1.2 K$

MAXIMUM AMPLITUDE OCCURS AT CRITICAL COUPLING -
WHEN $K = \frac{1}{\sqrt{Q_p Q_s}}$

Figure 18.
Gain Equations for Pentode R-F Voltage Amplifier Stages
Operating into Tuned Circuit Load

to the input circuit feeding the grid as a resistance. The decrease in input resistance of a tube due to electron transit time varies as the square of the frequency. The undesirable effects of transit time can be reduced in certain cases by the use of higher plate voltages. Transit time varies inversely as the square root of the applied plate voltage.

Cathode lead inductance is an additional cause of reduced input resistance at high frequencies. This effect has been reduced in certain tubes such as the 6SH7 and the 6AK5 by providing two cathode leads on the tube base. One cathode lead should be connected to the input circuit of the tube and the other lead should be connected to the by-pass capacitor for the plate return of the tube.

4-11 Plate-Circuit Considerations

Noise is generated in a vacuum tube by the fact that the current flow within the tube is not a continuous flow but rather is made up of the continuous arrival of particles (electrons) at a very high rate. This "shot effect" is a source of noise in the tube, but its effect is referred back to the grid circuit of the tube since it is included in the "equivalent noise resistance" discussed in the preceding paragraphs.

So, for the purpose of this section, it will be considered that the function of the plate load circuit of a tuned vacuum-tube amplifier is to deliver energy to the next stage with the greatest efficiency over the required band of frequencies. Three methods of interstage coupling for tuned r-f voltage amplifiers are shown in Figure 18. In Figure 18A ω is 2π times the resonant frequency of the circuit in the plate of the ampli-

fier tube, and L and Q are the inductance and Q of the inductor L . In Figure 18B the notation is the same and M is the mutual inductance between the primary coil and the secondary coil. In Figure 18C the notation is again the same and k is the coefficient of coupling between the two tuned circuits. As the coefficient of coupling between the circuits is increased the bandwidth becomes greater but the response over the band becomes progressively more double-humped. The response over the band is the most flat when the Q 's of primary and secondary are approximately the same and the value of each Q is equal to $1.75/k$.

Variable-Mu Tubes It is common practice to control the gain of a succession of r-f or i-f amplifier stages by varying the average bias on their control grids. However, as the bias is raised above the operating value on a conventional sharp-cutoff tube the tube becomes increasingly non-linear in operation as cutoff of plate current is approached. The effect of such non-linearity is to cause cross modulation between strong signals which appear on the grid

of the tube. When a tube operating in such a manner is in one of the first stages of a receiver a number of signals are appearing on its grid simultaneously and cross modulation between them will take place. The result of this effect is to produce a large number of spurious signals in the output of the receiver—in most cases these signals will carry the modulation of both the carriers which have been cross modulated to produce the spurious signal.

The undesirable effect of cross modulation can be eliminated in most cases and greatly reduced in the balance through the use of a variable-mu tube in all stages which have a-v-c voltage or other large negative bias applied to their grids. The variable-mu tube has a characteristic which causes the cutoff of plate current to be gradual with an increase in grid bias, and the reduction in plate current is accompanied by a decrease in the effective amplification factor of the tube. Variable-mu tubes ordinarily have somewhat reduced G_m as compared to a sharp-cutoff tube of the same group. Hence the sharp-cutoff tube will perform best in stages to which a-v-c voltage is not applied.

RADIO-FREQUENCY POWER AMPLIFIERS

All modern transmitters in the medium-frequency range and an increasing percentage of those in the v-h-f and u-h-f ranges consist of a comparatively low-level source of radio-frequency energy which is multiplied in frequency and successively amplified to the desired power level. Microwave transmitters are still predominately of the self-excited oscillator type, but when it is possible to use r-f amplifiers in s-h-f transmitters the flexibility of their application will be increased. The following portion of this chapter will be devoted, however, to the method of operation and calculation of operating characteristics of r-f power amplifiers for operation in the range of approximately 3.5 to 500 Mc.

4-12 Class C R-F Power Amplifiers

The majority of r-f power amplifiers fall into the Class C category since such stages can be made to give the best plate circuit efficiency of any present type of vacuum-tube amplifier. Hence, the cost of tubes for such a stage and the cost of the power to supply that stage is least for any given power output. Nevertheless, the Class C amplifier gives less power gain than either a Class A or Class B amplifier under similar conditions since the grid of a Class C stage must be driven highly positive over the portion of the cycle of the exciting wave when the plate voltage on the amplifier is low, and must be at a large negative potential over a large portion of the cycle so that no plate current will flow except when plate voltage is very low. This, in fact, is the fundamental reason why the plate circuit efficiency of a Class C amplifier stage can be made high—plate current is cut off at all times except when the plate-to-cathode voltage drop across the tube is at its lowest value. Class C amplifiers almost invariably operate into a tuned tank circuit as a load, and as a result are used as amplifiers of a single frequency or of a comparatively narrow band of frequencies.

Figure 18 shows the relationships between the various voltages and currents over one cycle of the exciting grid voltage for a Class C amplifier stage. The notation given in Figure 18 and in the discussion to follow is the same as given at the first of this chapter under "Symbols for Vacuum-Tube Parameters".

Recommended operating conditions for various types of vacuum tubes as Class C amplifiers are given in tabular form in Chapter 17. The various manufacturers of vacuum tubes also publish booklets listing in more detail alternative Class C

operating conditions for the tubes which they manufacture. In addition, operating condition sheets for any particular type of vacuum tube are available for the asking from the different vacuum-tube manufacturers. It is, nevertheless, often desirable to determine optimum operating conditions for a tube under a particular set of circumstances. To assist in such calculations the following paragraphs are devoted to a method of calculating Class C operating conditions which is moderately simple and yet sufficiently accurate for all practical purposes.

Calculation of Class C Amplifier Operating Characteristics*

Although Class C operating conditions can be determined with the aid of the more conventional grid voltage-plate current operating curves, the calculation is considerably simplified if the alternative "constant-current curve" of the tube in question is used. This is true since the operating line of a Class C amplifier is a straight line on a set of constant-current curves. A set of constant-current curves on the 250TH tube with a sample load line drawn thereon is shown in Figure 22.

In calculating and predicting the operation of a vacuum tube as a Class C radio-frequency amplifier, the considerations which determine the operating conditions are plate efficiency, power output required, maximum allowable plate and grid dissipation, maximum allowable plate voltage and maximum allowable plate current. The values chosen for these factors will depend both upon the demands of a particular application and upon the tube chosen.

The plate and grid currents of a Class C amplifier tube are periodic pulses, the durations of which are always less than 180 degrees. For this reason the average grid current, average plate current, power output, driving power, etc., cannot be directly calculated but must be determined by a Fourier analysis from points selected at proper intervals along the line of operation as plotted upon the constant-current characteristics. This may be done either analytically or graphically. While the Fourier analysis has the advantage of accuracy, it also has the disadvantage of being tedious and involved.

The approximate analysis which follows has proven to be sufficiently accurate for most applications. This type of analysis also has the advantage of giving the desired information at the first trial. The system is direct in giving the desired information since the important factors, power output, plate effi-

ciency, and plate voltage are arbitrarily selected at the beginning.

Method of Calculation The first step in the method to be described is to determine the power which must be delivered by the Class C amplifier. In making this determination it is well to remember that ordinarily from 5 to 10 per cent of the power delivered by the amplifier tube or tubes will be lost in well-designed tank and coupling circuits at frequencies below 20 Mc. Above 20 Mc. the tank and circuit losses are ordinarily somewhat above 10 per cent.

The plate power input necessary to produce the desired output is determined by the plate efficiency: $P_{in} = P_{out}/N_p$.

For most applications it is desirable to operate at the highest practicable efficiency. High-efficiency operation usually requires less expensive tubes and power supplies, and the amount of artificial cooling required is frequently less than for low-efficiency operation. On the other hand, high-efficiency operation usually requires more driving power and involves the use of higher plate voltages and higher peak tube voltages. The better types of triodes will ordinarily operate at a plate efficiency of 75 to 85 per cent at the highest rated plate voltage, and at a plate efficiency of 65 to 75 per cent at intermediate values of plate voltage.

The first determining factor in selecting a tube or tubes for a particular application is the amount of plate dissipation which will be required of the stage. The total plate dissipation rating for the tube or tubes to be used in the stage must be equal to or greater than that calculated from: $P_p = P_{in} - P_{out}$.

After selecting a tube or tubes to meet the power output and plate dissipation requirements it becomes necessary to determine from the tube characteristics whether the tube selected is capable of the desired operation and, if so, to determine the driving power, grid bias, and grid dissipation.

The complete procedure necessary to determine a set of Class C amplifier operating conditions is given in the following steps:*

1. Select plate voltage, power output, and efficiency.
2. Determine plate input from: $P_{in} = P_{out}/N_p$.
3. Determine plate dissipation from: $P_p = P_{in} - P_{out}$. P_p must not exceed maximum rated plate dissipation for tube or tubes selected.
4. Determine average plate current from: $I_b = P_{in}/E_{bb}$.
5. Determine approximate i_{pmax} from:
 $i_{pmax} = 4.9 I_b$ for $N_p = 0.85$
 $i_{pmax} = 4.5 I_b$ for $N_p = 0.80$
 $i_{pmax} = 4.0 I_b$ for $N_p = 0.75$
 $i_{pmax} = 3.5 I_b$ for $N_p = 0.70$
6. Locate the point on constant-current characteristics where the constant plate current line corresponding to the approximate i_{pmax} determined in step 5 crosses the line of equal plate and grid voltages (diode line). Read e_{pmin} at this point. In a few cases the lines of constant plate current will inflect sharply upward before reaching the diode line. In these cases e_{pmin} should not be read at the diode line but at the point where the plate current line intersects a line drawn from the origin through these points of inflection.
7. Calculate E_{pm} from: $E_{pm} = E_{bb} - e_{pmin}$.
8. Calculate the ratio I_{pm}/I_b from:

$$\frac{I_{pm}}{I_b} = \frac{2 N_p E_{bb}}{E_{pm}}$$

9. From the ratio of I_{pm}/I_b calculated in step 8 determine the ratio i_{pmax}/I_b from Figure 20.

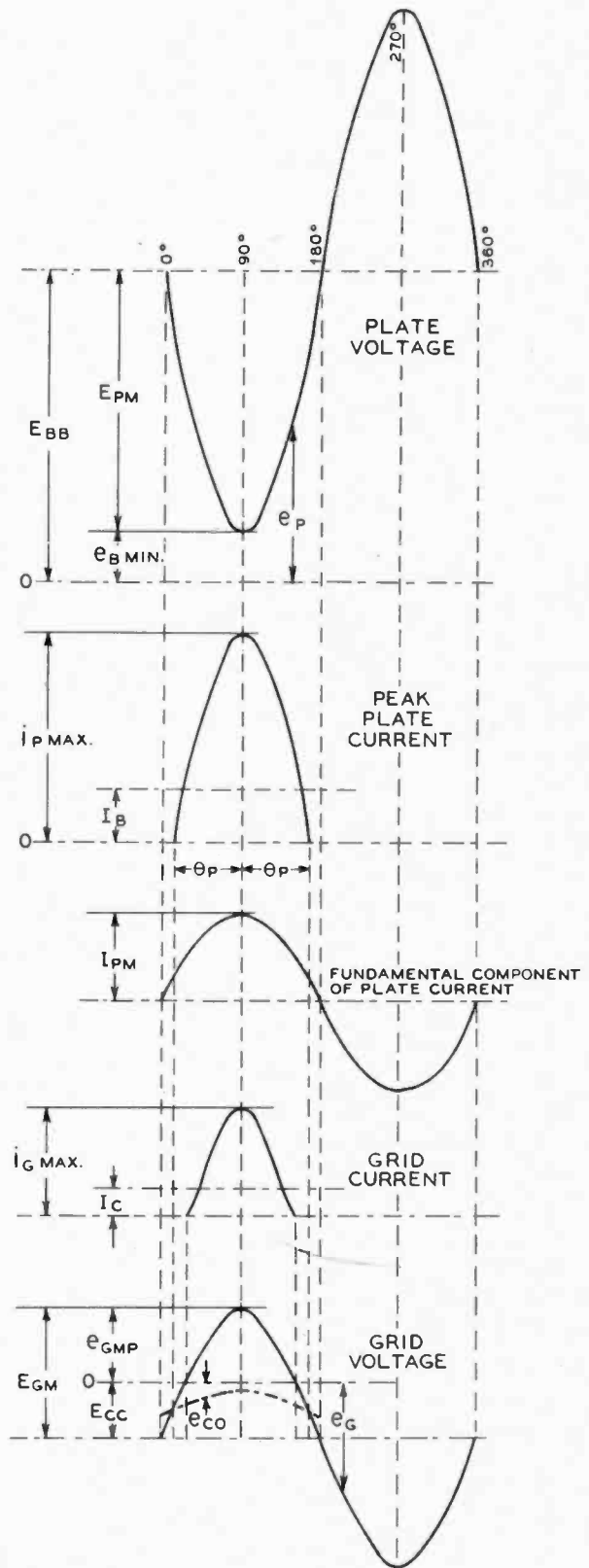

Figure 19. Instantaneous electrode and tank circuit voltages and currents for a Class C r-f amplifier.

*Adapted from a procedure given in the Mar.-April 1945, *Eimac News*.

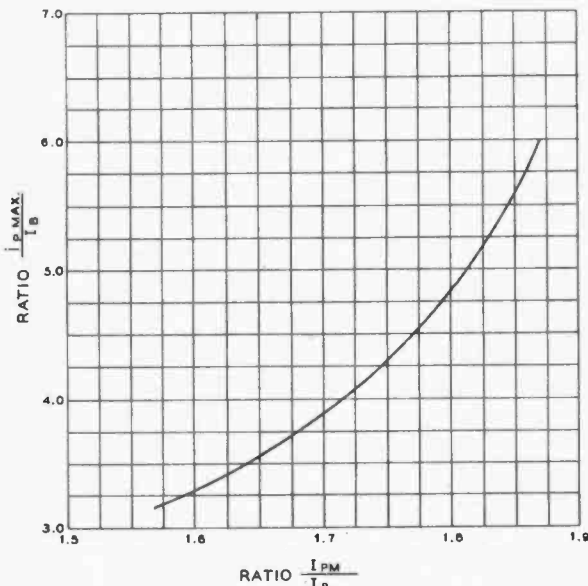

Figure 20.

Relationship between the ratio of peak value of fundamental component of tube plate current and average plate current, and the ratio of instantaneous peak value of tube plate current and average plate current.

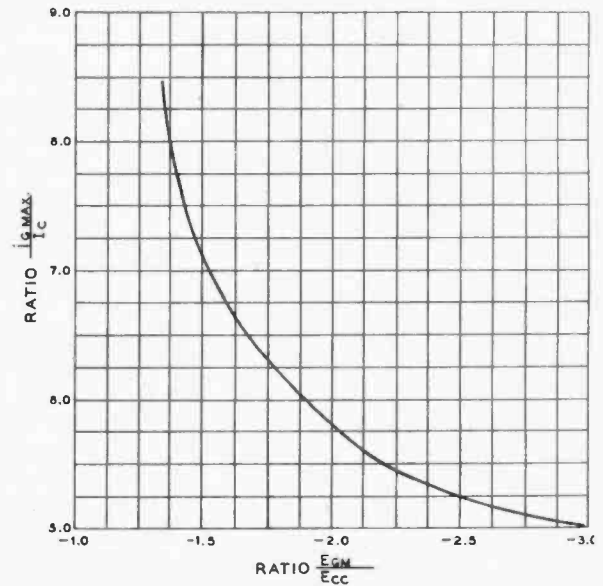

Figure 21.

Relationship between the ratio of peak value of fundamental component of grid excitation voltage and average grid bias, and the ratio between instantaneous peak grid current and average grid current.

- Calculate a new value for i_{pmax} from the ratio found in step 9.

$$i_{pmax} = (\text{ratio from step 9}) I_b$$

- Read e_{gmp} and i_{cmax} from the constant-current characteristics for the values of e_{pmin} and i_{pmax} determined in steps 6 and 10.
- Calculate the cosine of one-half the angle of plate current flow from:

$$\cos \theta_p = 2.32 \left(\frac{I_{pm}}{I_b} - 1.57 \right)$$

- Calculate the grid bias voltage from:

$$E_{cc} = \frac{1}{1 - \cos \theta_p} \left[\cos \theta_p \left(\frac{E_{pm}}{\mu} - e_{gmp} \right) - \frac{E_{hb}}{\mu} \right]$$

- Calculate the peak fundamental grid excitation voltage from:

$$E_{gm} = e_{gmp} - E_{cc}$$

- Calculate the ratio E_{gm}/E_{cc} for the values of E_{cc} and E_{gm} found in steps 13 and 14.

- Read i_{gmax}/I_c from Figure 21 for the ratio E_{gm}/E_{cc} found in step 15.

- Calculate the average grid current from the ratio found in step 16, and the value of i_{gmax} found in step 11:

$$I_c = \frac{i_{gmax}}{\text{Ratio from step 16}}$$

- Calculate approximate grid driving power from:

$$P_d = 0.9 E_{gm} I_c$$

- Calculate grid dissipation from:

$$P_g = P_d + E_{cc} I_c$$

P_g must not exceed the maximum rated grid dissipation for the tube selected.

Sample Calculation A typical example of a Class C amplifier calculation is shown in the example below. Reference is made to Figures 20, 21, and 22 in the calculation.

- Desired power output—800 watts
Desired plate voltage—3500 volts
Desired plate efficiency—80 per cent ($N_p = 0.80$)
- $P_{in} = 800/0.80 = 1000$ watts
- $P_p = 1000 - 800 = 200$ watts
Use 250TH; max. $P_p = 250$ w.; $\mu = 37$.
- $I_b = 1000/3500 = 0.285$ ampere (285 ma.)
Max. I_b for 250TH is 350 ma.
- Approximate $i_{pmax} = 0.285 \times 4.5 = 1.28$ ampere
- $e_{pmin} = 260$ volts (see Figure 22, first trial point)
- $E_{pm} = 3500 - 260 = 3240$ volts
- $I_{pm}/I_b = 2 \times 0.80 \times 3500/3240 = 5600/3240 = 1.73$
- $i_{pmax}/I_b = 4.1$ (from Figure 20)
- $i_{pmax} = 0.285 \times 4.1 = 1.17$
- $e_{gmp} = 240$ volts
 $i_{gmax} = 0.430$ amperes
(Both above from final point on Figure 22)
- $\cos \theta_p = 2.32 (1.73 - 1.57) = 0.37$ ($\theta_p = 68.3^\circ$)

$$E_{cc} = \frac{1}{1 - 0.37} \left[0.37 \left(\frac{3240}{37} - 240 \right) - \frac{3500}{37} \right] = -240 \text{ volts}$$

- $E_{gm} = 240 - (-240) = 480$ volts grid swing
- $E_{gm}/E_{cc} = 480/-240 = -2$
- $i_{gmax}/I_c = 5.75$ (from Figure 21)
- $I_c = 0.430/5.75 = 0.075$ amp. (75 ma. grid current)
- $P_d = 0.9 \times 480 \times 0.075 = 32.5$ watts driving power
- $P_g = 32.5 - (-240 \times 0.075) = 14.5$ watts grid dissipation
Max. P_g for 250TH is 40 watts

The power output of any type of r-f amplifier is equal to:

$$I_{pm} E_{pm} / 2 = P_o$$

I_{pm} can be determined, of course, from the ratio determined in step 8 above (in this type of calculation) by multiplying this ratio times I_b .

It is frequently of importance to know the value of load impedance into which a Class C amplifier operating under a certain set of conditions should operate. This is simply $R_L = E_{pm}/I_{pm}$. In the case of the operating conditions just determined

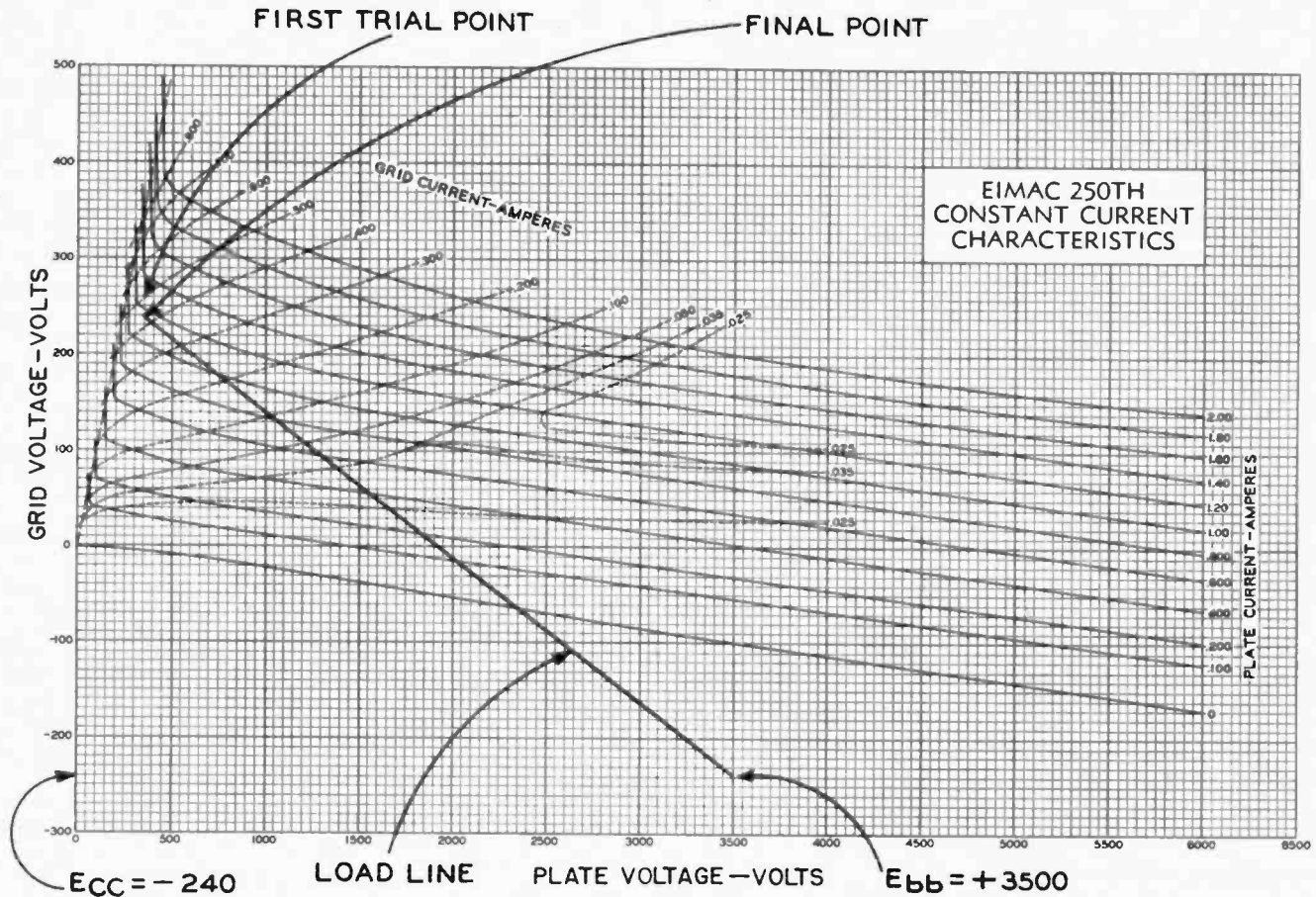

Figure 22.

Operating load line for an Eimac 250TH triode Class C r-f power amplifier showing first trial point and final peak operating point and load line.

for a 250TH amplifier stage the value of load impedance is:

$$R_L = \frac{E_{p.m}}{I_{p.m}} = \frac{3240}{.495} = 6600 \text{ ohms} \quad I_{p.m} = \frac{I_{p.m}}{I_b} \times I_b$$

Q of Amplifier Tank Circuit In order to obtain good plate tank circuit tuning and low radiation of harmonics from an amplifier it is necessary that the plate tank circuit have a minimum Q. Charts giving compromise values of Q for Class C amplifiers are given in Chapter 9, Transmitter Design and Control Principles. However, the amount of inductance required for a specified tank circuit Q under specified operating conditions can be calculated from the following expression:

$$\omega L = \frac{R_L}{Q} \quad \begin{aligned} \omega &= 2\pi \times \text{operating frequency} \\ L &= \text{Tank inductance} \\ R_L &= \text{Required tube load impedance} \\ Q &= \text{Effective tank circuit Q} \end{aligned}$$

A tank circuit Q of 12 is recommended for all normal conditions. However, if a balanced push-pull amplifier is employed the tank receives two impulses per cycle and the circuit Q may be lowered to 6.

Quick Method of Calculating Amplifier Plate Efficiency The plate circuit efficiency of a Class B or Class C r-f amplifier can be determined from the following facts.

The plate circuit efficiency of such an amplifier is equal to the product of two factors, F_1 , which is equal to the ratio of $E_{p.m}$ to E_{bb} ($F_1 = E_{p.m}/E_{bb}$) and F_2 , which is proportional to the one-half angle of plate current flow, θ_p . A

graph of F_2 against both θ_p and $\cos \theta_p$ is given in Figure 23. Either θ_p or $\cos \theta_p$ may be used to determine F_2 . $\cos \theta_p$ may be determined either from the procedure previously given for making Class C amplifier computations or it may be determined from the following expression:

$$\cos \theta_p = - \frac{\mu E_{cc} + E_{bb}}{\mu E_{gm} - E_{p.m}}$$

Example of Method It is desired to know the one-half angle of plate current flow and the plate circuit efficiency for an 812 tube operating under the following conditions which have been assumed from inspection of the data and curves given in the RCA Transmitting Tube Handbook HB-3:

1. $E_{bb} = 1100$ volts
 $E_{cc} = -40$ volts
 $\mu = 29$
 $E_{gm} = 120$ volts
 $E_{p.m} = 1000$ volts
2. $F_1 = E_{p.m}/E_{bb} = 0.91$

$$3. \cos \theta_p = \frac{-29 \times 40 + 1100}{29 \times 120 - 1000} = \frac{60}{2480} = 0.025$$

$$4. F_2 = 0.79 \text{ (by reference to Figure 23)}$$

$$5. N_p = F_1 \times F_2 = 0.91 \times 0.79 = 0.72 \text{ (72 per cent efficiency)}$$

F_1 could be called the plate-voltage-swing efficiency factor, and F_2 can be called the operating-angle efficiency factor or the

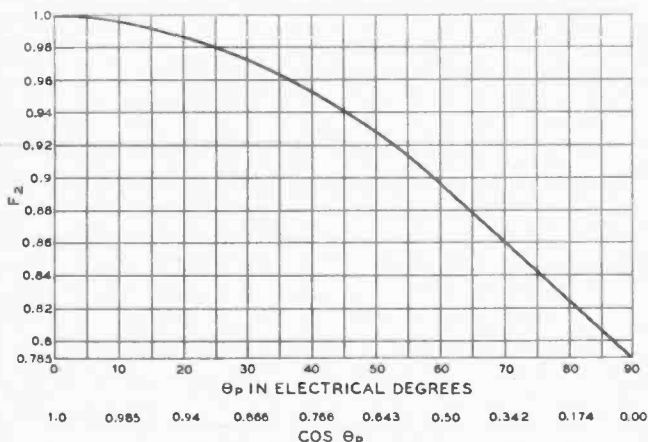

Figure 23.

Relationship between Factor F_2 and the half-angle of plate current flow in an amplifier of sine waves operating at a bias greater than cutoff.

maximum possible efficiency of any stage running with that value of half-angle of plate current flow.

N_p is, of course, only the ratio between power output and power input. If it is desired to determine the power input, exciting power, and grid current of the stage, these can be obtained through use of steps 7, 8, 9, and 10 of the previously given method for power input and output; and knowing that i_{gmax} is 0.095 ampere the grid circuit conditions can be determined through the use of steps 15, 16, 17, 18 and 19.

4-13 Class B Radio Frequency Power Amplifiers

Radio frequency power amplifiers operating under Class B conditions of grid bias and excitation voltage are used in two general types of applications in transmitters. The first-general application is as a buffer amplifier stage where it is desired to obtain a high value of power amplification in a particular stage. A particular tube type operated with a given plate voltage will be capable of somewhat greater output for a certain amount of excitation power when operated as a Class B amplifier than when operated as a Class C amplifier. Calculation of the operating conditions for this type of Class B r-f amplifier can be carried out in a manner similar to that described in the previous paragraphs, except that the grid bias voltage is set on the tube before calculation at the value: $E_{cc} = -E_{bb}/\mu$. Since the grid bias is set at cutoff the one-half angle of plate current flow is 90° ; hence $\cos \theta_p$ is fixed at 0.00. The plate circuit efficiency for a Class B r-f amplifier operated in this manner can be determined in the following manner:

$$N_p = 78.5 \left(\frac{E_{pm}}{E_{bb}} \right)$$

The second type of Class B r-f amplifier is the so-called "Class B linear amplifier" which is often used in commercial transmitters for the amplification of an amplitude-modulated wave. Calculation of operating conditions is carried out in a manner similar to that previously described with the following exceptions: The first trial operating point is chosen on the basis of the 100 per cent positive modulation peak of the modulated exciting wave. The plate circuit and grid circuit peak voltages and currents can then be determined and the power input and output calculated. Then, with the exciting voltage reduced to one-half for the no-modulation condition of the exciting wave, and with the same value of load resistance reflected on the tube, the plate input and plate efficiency will drop to approximately one-half the values at the 100 per cent positive modulation peak and the power output of the stage will drop to

one-fourth the peak-modulation value. On the negative modulation peak the input, efficiency, and output all drop to zero.

4-14 Special R-F Power Amplifier Circuits

The r-f power amplifier discussions of Sections 4-12 and 4-13 have been based on the assumption that a conventional grounded-cathode or cathode-return type of amplifier was in question. It is possible, however, as in the case of a-f and low-level r-f amplifiers to use circuits in which electrodes other than the cathode are returned to ground insofar as the signal potential is concerned. Both the plate-return or cathode-follower amplifier and the grid-return or grounded-grid amplifier are effective in certain circuit applications as tuned r-f power amplifiers.

Grounded-Grid R-F Power Amplifiers

An undesirable aspect of the operation of cathode-return r-f power amplifiers using triode tubes is that such amplifiers must be neutralized. Principles and methods of neutralizing r-f power amplifiers is discussed in Chapter 9, Transmitter Design and Control Principles. As the frequency of operation of an amplifier is increased the stage becomes more and more difficult to neutralize due to inductance in the grid and plate leads of the tubes and in the leads to the neutralizing capacitors. In other words the bandwidth of neutralization decreases as the frequency is increased. In addition the very presence of the neutralizing capacitors adds additional undesirable capacitive loading to the grid and plate tank circuits of the tube or tubes. To look at the problem in another way, an amplifier that may be perfectly neutralized at a frequency of 30 Mc. may be completely out of neutralization at a frequency of 120 Mc. Hence, if there are circuits in both the grid and plate circuits which offer appreciable impedance at this high frequency it is quite possible that the stage may develop a "parasitic oscillation" in the vicinity of 120 Mc.

This condition of restricted-range neutralization of r-f power amplifiers can be greatly alleviated through the use of a cathode-return or grounded-grid r.f. stage. The grounded-grid amplifier has the following advantages:

1. The output capacitance of a stage is reduced to approximately one-half the value which would be obtained if the same tube or tubes were operated as a conventional neutralized amplifier.
2. The tendency toward parasitic oscillations in such a stage is greatly reduced since the shielding effect of the control grid between the filament and the plate is effective over a broad range of frequencies.
3. The feedback capacitance within the stage is the plate-to-cathode capacitance which is ordinarily very much less than the grid-to-plate capacitance. Hence neutralization is ordinarily not required. If neutralization is required the neutralizing capacitors are very small in value and are cross connected between plates and cathodes in a push-pull stage, or between the opposite end of a split plate tank and the cathode in a single-ended stage.

The disadvantages of a grounded-grid amplifier are:

1. A large amount of excitation energy is required. However, only the normal amount of energy is lost in the grid circuit of the amplifier tube; all additional energy over this amount is delivered to the load circuit as useful output.
2. The cathode of a grounded-grid amplifier stage is "hot" to r.f. This means that the cathode must be fed through a suitable impedance from the filament supply, or the secondary of the filament transformer must be of the low-capacitance type and adequately insulated for the r-f voltage which will be present.

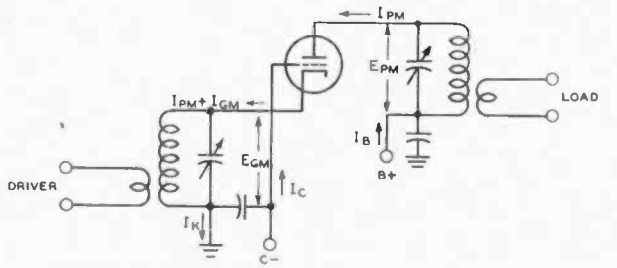

$$\begin{aligned} \text{POWER OUTPUT TO LOAD} &= \frac{(E_{GM} + E_{PM}) I_{PM}}{2} \text{ OR } \frac{E_{PM} I_{PM}}{2} + \frac{E_{GM} I_{PM}}{2} \\ \text{POWER DELIVERED BY OUTPUT TUBE} &= \frac{E_{PM} I_{PM}}{2} \\ \text{POWER FROM DRIVER TO LOAD} &= \frac{E_{GM} I_{PM}}{2} \\ \text{TOTAL POWER DELIVERED BY DRIVER} &= \frac{E_{GM} (I_{PM} + I_{GM})}{2} \\ &\text{OR } \frac{E_{GM} I_{PM}}{2} + 0.9 E_{GM} I_C \\ \text{POWER ABSORBED BY OUTPUT TUBE GRID AND BIAS SUPPLY:} & \\ &= \frac{E_{GM} I_{GM}}{2} \text{ OR } 0.9 E_{GM} I_C \\ Z_K \text{ (APPROXIMATELY)} &= \frac{E_{GM}}{I_{PM} + 1.0 I_C} \end{aligned}$$

Figure 24.

GROUNDING-GRID CLASS B OR CLASS C AMPLIFIER.

The equations in the above figure give the relationships between the fundamental components of grid and plate potential and current, and the power input and power output of the stage. An expression for the approximate cathode impedance is also given.

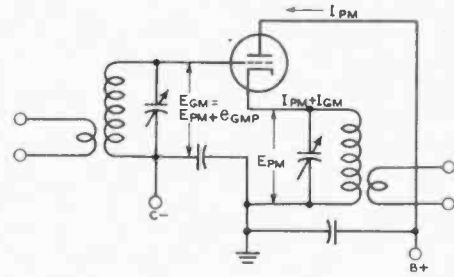

$$\begin{aligned} \text{POWER OUTPUT TO LOAD} &= \frac{E_{PM} (I_{PM} + I_{GM})}{2} \\ \text{POWER DELIVERED BY OUTPUT TUBE} &= \frac{E_{PM} I_{PM}}{2} \\ \text{POWER FROM DRIVER TO LOAD} &= \frac{E_{PM} I_{GM}}{2} \\ \text{TOTAL POWER FROM DRIVER} &= \frac{E_{GM} I_{GM}}{2} = \frac{(E_{PM} + E_{GMP}) I_{GM}}{2} \\ &= \text{APPROX. } \frac{(E_{PM} + E_{GMP}) 1.0 I_C}{2} \\ &\text{ASSUMING } I_{GM} \cong 1.0 I_C \\ \text{POWER ABSORBED BY OUTPUT TUBE GRID AND BIAS SUPPLY:} & \\ &= \text{APPROX. } 0.9 (E_{CC} + E_{GMP}) I_C \\ Z_G = \frac{E_{GM}}{I_{GM}} &= \text{APPROX. } \frac{(E_{PM} + E_{GMP})}{1.0 I_C} \end{aligned}$$

Figure 25.

CATHODE-FOLLOWER R-F POWER AMPLIFIER.

Relationships between tube potentials and currents and the input and output power of the stage.

3. A grounded-grid r-f amplifier cannot be plate modulated 100 per cent unless the output of the exciting stage is modulated also. Approximately 70 per cent modulation of the exciter stage as the final stage is being modulated 100 per cent is recommended. However, the grounded-grid r-f amplifier is quite satisfactory as a Class B linear r-f amplifier for modulated waves or as an amplifier for a straight c-w or FM signal.

Figure 24 shows a simplified representation of a grounded-grid triode r-f power amplifier stage. The relationships between input and output power and the peak fundamental components of electrode voltages and currents are given below the drawing. The calculation of the complete operating conditions for a grounded-grid amplifier stage is somewhat more complex than that for a conventional amplifier because the input circuit of the tube is in series with the output circuit as far as the load is concerned. The primary result of this effect is, as stated before, that considerably more power is required from the driver stage. The normal power gain for a g-g stage is from 3 to 15 depending upon the grid circuit conditions chosen for the output stage. The higher the grid bias and grid swing required on the output stage, the higher will be the requirement from the driver.

Calculation of Operating Conditions of Grounded Grid R-F Amplifiers

It is most convenient to determine the operating conditions for a Class B or Class C grounded-grid r-f power amplifier in a two-step process.

The first step is to determine the plate-circuit and grid-circuit operating conditions of the tube as though it were to operate as a conventional cathode-return amplifier stage. The second step is then to add in the additional conditions imposed upon the operating conditions by the fact that the stage is to operate as a grounded-grid amplifier.

For the first step in the calculation the procedure given in

Section 4-12 is quite satisfactory and will be used in the example to follow. Suppose we take for our example the case of a type 304TL tube operating at 2700 plate volts at a kilowatt input. Following through the procedure previously given:

1. Desired power output—850 watts
Desired Plate voltage—2700 volts
Desired plate efficiency—85 per cent ($N_p = 0.85$)
2. $P_{in} = 850/0.85 = 1000$ watts
3. $P_p = 1000 - 850 = 150$ watts
Type 304TL chosen; max. $P_p = 300$ watts, $\mu = 12$.
4. $I_b = 1000/2700 = 0.370$ ampere (370 ma.)
5. Approximate $i_{pmax} = 4.9 \times 0.370 = 1.81$ ampere
6. $e_{pmin} = 140$ volts (from 304TL constant-current curves)
7. $E_{pm} = 2700 - 140 = 2560$ volts
8. $I_{pm}/I_b = 2 \times 0.85 \times 2700/2560 = 1.79$
9. $i_{pmax}/I_b = 4.65$ (from Figure 20)
10. $i_{pmax} = 4.65 \times 0.370 = 1.72$ amperes
11. $e_{gmp} = 140$ volts
 $i_{gmax} = 0.480$ amperes
12. $\cos \theta_p = 2.32 (1.79 - 1.57) = 0.51$
 $\theta_p = 59^\circ$
13. $E_{ce} = \frac{1}{1-0.51} \left[0.51 \left(\frac{2560}{12} - 140 \right) - \frac{2700}{12} \right]$
 $= -385$ volts
14. $E_{gm} = 140 - (-385) = 525$ volts
15. $E_{gm}/E_{ce} = -1.36$
16. $i_{gmax}/I_c = \text{approx. } 8.25$ (extrapolated from Figure 21)
17. $I_c = 0.480/8.25 = 0.058$ (58 ma. d-c grid current)
18. $P_d = 0.9 \times 525 \times 0.058 = 27.5$ watts
19. $P_k = 27.5 - (-385 \times 0.058) = 5.2$ watts.
Max. P_k for 304TL is 50 watts

We can check the operating plate efficiency of the stage by the method described in Section 4-12 as follows:

$$F_1 = E_{p1m}/E_{b1} = 2560/2700 = 0.95$$

$$F_2 \text{ for } \theta_p \text{ of } 59^\circ \text{ (from Figure 23)} = 0.90$$

$$N_p = F_1 \times F_2 = 0.95 \times 0.90 = \text{approx. } 0.85 \text{ (85 per cent plate efficiency)}$$

Now, to determine the operating conditions as a grounded-grid amplifier we must also know the peak value of the fundamental component of plate current. This is simply equal to $(I_{p1m}/I_b) I_b$, or:

$$I_{p1m} = 1.79 \times 0.370 = 0.660 \text{ amperes (from 4 and 8 above)}$$

The total average power required of the driver (from Figure 24) is equal to $E_{g1m} I_{p1m} / 2$ (since the grid is grounded and the grid swing appears also as cathode swing) plus P_a which is 27.5 watts from 18 above. The total is:

$$\text{Total drive} = \frac{525 \times 0.660}{2} = 172.5 \text{ watts plus } 27.5 \text{ watts or } 200 \text{ watts}$$

Therefore the total power output of the stage is equal to 850 watts (contributed by the 304TL) plus 172.5 watts (contributed by the driver) or 1022.5 watts. The cathode driving impedance of the 304TL (again referring to Figure 24) is approximately:

$$Z_k = 525 / (0.660 + 0.116) = \text{approximately } 675 \text{ ohms.}$$

Plate-Return or Cathode-Follower R-F Power Amplifier

Circuit diagram, electrode potentials and currents, and operating conditions for a cathode-follower r-f power amplifier are given in Figure 25. This

circuit can be used, in addition to the grounded-grid circuit just discussed, as an r-f amplifier with a triode tube and no additional neutralization circuit. However, the circuit will oscillate if the impedance from cathode to ground is allowed to become capacitive rather than inductive or resistive with respect to the operating frequency. The circuit is not recommended except for u-h-f work with coaxial lines as tuned circuits since the peak grid swing required on the r-f amplifier stage is approximately equal to the plate voltage on the amplifier tube if high-efficiency operation is desired. This means, of course, that the grid tank must be able to withstand slightly more peak voltage than the plate tank. Such a stage may not be plate modulated unless the driver stage is modulated the same percentage as the final amplifier. It may be used as an amplifier of modulated waves (Class B linear) or as a c-w or FM amplifier however.

The design of such an amplifier stage is essentially the same as the design of a grounded-grid amplifier stage as far as the first step is concerned. Then, for the second step the operating conditions given in Figure 25 are applied to the data obtained in the first step. As an example, take the 304TL stage previously described. The total power required of the driver will be (from Figure 25) approximately $(2700 \times 0.058 \times 1.8) / 2$ or 141 watts. Of this 141 watts 27.5 watts (as before) will be lost as grid dissipation and bias loss and the balance of 113.5 watts will appear as output. The total output of the stage will then be approximately 963 watts.

Cathode Tank for G-G or C-F Power Amplifier

The cathode tank circuit for either a grounded-grid or cathode-follower r-f power amplifier may be a conventional tank circuit if the filament transformer

for the stage is of the low-capacitance high-voltage type. Conventional filament transformers, however, will not operate with the high values of r-f voltage present in such a circuit. If a conventional filament transformer is to be used the cathode tank coil may consist of two parallel heavy conductors (to carry the high filament current) by-passed at both the ground



$$\text{VOLTAGE AMPLIFICATION WITH FEEDBACK} = \frac{A}{1 - A\beta}$$

A = GAIN IN ABSENCE OF FEEDBACK

β = FRACTION OF OUTPUT VOLTAGE FED BACK

β IS NEGATIVE FOR NEGATIVE FEEDBACK

$$\text{FEEDBACK IN DECIBELS} = 20 \text{ LOG } (1 - A\beta)$$

$$= 20 \text{ LOG } \frac{\text{MID FREQ. GAIN WITHOUT FEEDBACK}}{\text{MID FREQ. GAIN WITH FEEDBACK}}$$

$$\text{DISTORTION WITH FEEDBACK} = \frac{\text{DISTORTION WITHOUT FEEDBACK}}{(1 - A\beta)}$$

$$R_0 = \frac{R_N}{1 - A\beta (1 + \frac{R_N}{R_L})}$$

WHERE:

R₀ = OUTPUT IMPEDANCE OF AMPLIFIER WITH FEEDBACK

R_N = OUTPUT IMPEDANCE OF AMPLIFIER WITHOUT FEEDBACK

R_L = LOAD IMPEDANCE INTO WHICH AMPLIFIER OPERATES

Figure 26.

Feedback Amplifier Relationships.

end and at the tube socket. The tuning capacitor is then placed between filament and ground. It is possible in certain cases to use two r-f chokes of special design to feed the filament current to the tubes, with a conventional tank circuit between filament and ground. Coaxial lines also may be used to serve both as cathode tank and filament feed to the tubes for v-h-f and u-h-f work.

4-15 Feedback Amplifiers

It is possible to modify the characteristics of an amplifier by feeding back a portion of the output to the input. All components, circuits, and tubes included between the point where the feedback is taken off and the point where the feedback energy is inserted are said to be included within the feedback loop. An amplifier containing a feedback loop is said to be a feedback amplifier. One stage or any number of stages may be included within the feedback loop. However, the difficulty of obtaining proper operation of a feedback amplifier increases with the bandwidth of the amplifier, and with the number of stages and circuit elements included within the feedback loop.

The gain and phase shift of any amplifier are functions of frequency. For any amplifier containing a feedback loop to be completely stable the gain of such an amplifier, as measured from the input back to the point where the feedback circuit connects to the input, must be less than one at the frequency where the feedback voltage is in phase with the input voltage of the amplifier. If the gain is equal to or more than one at the frequency where the fed back voltage is in phase with the input the amplifier will oscillate. This fact imposes a limitation upon the amount of feedback which may be employed in an amplifier which is to remain stable. If the reader is desirous of designing amplifiers in which a large amount of feedback is to be employed he is referred to a paper and a book on the subject by H. W. Bode.*

Feedback may be either negative or positive, and the feedback voltage may be proportional either to output voltage or output current. The most commonly used type of feedback with a-f or video amplifiers is negative feedback proportional to output voltage. Figure 26 gives the general operating con-

*H. W. Bode, "Relations Between Attenuation and Phase in Feedback Amplifiers," *Bell System Technical Journal*, July, 1940, pgs. 421. H. W. Bode, "Network Analysis and Feedback Amplifier Design," D. Van Nostrand Co., Inc., 250 Fourth Ave., New York 3, N.Y.

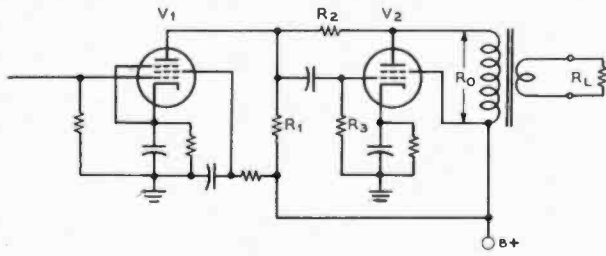

$$\text{DB FEEDBACK} = 20 \text{ LOG} \left[\frac{R_2 + R_A (G_{mV2} R_O)}{R_2} \right]$$

$$= 20 \text{ LOG} \left[\frac{R_2 + R_A (\text{VOLTAGE GAIN OF } V_2)}{R_2} \right]$$

$$\text{GAIN OF BOTH STAGES} = \left[G_{mV1} \left(\frac{R_B \times R_A}{R_B + R_A} \right) \right] \times (G_{mV2} R_O)$$

WHERE:

$$R_A = \frac{R_1 \times R_3}{R_1 + R_3}$$

$$R_B = \frac{R_2}{G_{mV2} R_O}$$

R_O = REFLECTED LOAD IMPEDANCE ON V_2

R_2 = FEEDBACK RESISTOR (USUALLY ABOUT 500 K)

$$\text{OUTPUT IMPEDANCE} = \frac{R_N R_2}{\left[R_2 + R_A (G_{mV2} R_O) \right] \times \left(1 + \frac{R_N}{R_O} \right)}$$

R_N = PLATE IMPEDANCE OF V_2

Figure 27.

SHUNT FEEDBACK CIRCUIT FOR PENTODES OR TETRODES.

This circuit is quite effective in lowering the plate impedance and reducing the harmonic distortion of pentode and tetrode audio-frequency power amplifier circuits. Design data is given above.

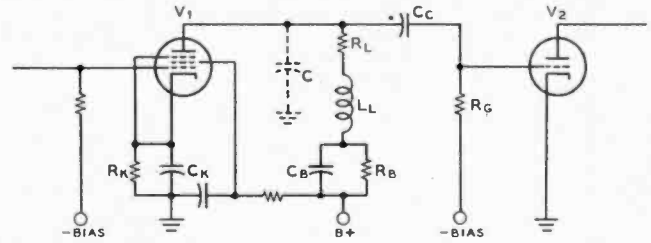

MID-FREQUENCY GAIN = $G_{mV1} R_L$

HIGH-FREQUENCY GAIN = $G_{mV1} Z_{\text{COUPLING NETWORK}}$

$C = C_{\text{OUT } V_1} + C_{\text{IN } V_2} + C_{\text{DISTRIBUTED}}$

FOR COMPROMISE HIGH FREQUENCY EQUALIZATION:

$X_{LL} = 0.5 X_C \text{ AT } f_C$

$R_L = X_C \text{ AT } f_C$

WHERE: f_C = CUTOFF FREQUENCY OF AMPLIFIER

L_L = PEAKING INDUCTOR

FOR COMPROMISE LOW FREQUENCY EQUALIZATION:

$R_B = R_K (G_{mV1} R_L)$

$R_B C_B = R_K C_K$

$C_K = 25 \text{ TO } 50 \mu\text{FD. IN PARALLEL WITH } .001 \text{ MICA}$

$C_B = \text{CAPACITANCE FROM ABOVE WITH } .001 \text{ MICA IN PARALLEL}$

Figure 28.

VIDEO AMPLIFIER CIRCUIT.

Design data for simplest video amplifier circuit with a single peaking inductor.

ditions for feedback amplifiers. Note that the reduction in distortion is proportional to the reduction in gain of the amplifier and that the reduction in the output impedance of the amplifier is somewhat greater than the reduction in the gain by an amount which is a function of the ratio of the output impedance of the amplifier without feedback to the load impedance. The reduction in noise and hum in those stages included within the feedback loop is proportional to the reduction in gain. However, due to the reduction in gain of the output section of the amplifier somewhat increased gain is required of the stages preceding the stages included within the feedback loop. Therefore the noise and hum output of the entire amplifier may or may not be reduced dependent upon the relative contributions of the first part and the latter part of the amplifier to hum and noise. If most of the noise and hum is coming from the stages included within the feedback loop the undesired signals will be reduced in the output from the complete amplifier. It is most frequently true in conventional amplifiers that hum and distortion come from the latter stages, hence these will be reduced by feedback, but thermal agitation and microphonic noise come from the first stage and will not be reduced but may be increased by feedback unless the feedback loop includes the first stage of the amplifier.

Figure 27 illustrates a very simple and effective application of negative voltage feedback to an output pentode or tetrode amplifier stage. The reduction in hum and distortion may amount to 15 to 20 db. The reduction in the effective plate impedance of the stage will be by a factor of 20 to 100 dependent upon the operating conditions. Several applications of this simple circuit have been made in equipments described in the construction portion of this book. The circuit is also commonly used in commercial equipment with tubes such as the 6SJ7 for V_1 , and the 6V6 or 6L6 for V_2 .

4-16 Video-Frequency Amplifiers

A video-frequency amplifier is one which has been designed to pass frequencies from the lower audio range (lower limit perhaps 50 cycles) to the middle r-f range (upper limit perhaps 4 to 6 megacycles). Such amplifiers, in addition to passing such an extremely wide frequency range, must be capable of amplifying this range with a minimum of amplitude, phase, and frequency distortion. Video amplifiers are commonly used in television, pulse communication, and radar work.

Tubes used in video amplifiers must have a high ratio of G_m to capacitance if a usable gain per stage is to be obtained. Especially designed tubes for this purpose are now available. Common tubes of this type are the 6AC7, 6AB7, 6AG7, and 6AK5. Since, at the upper frequency limits of a video amplifier the input and output shunting capacitances of the amplifier tubes have rather low values of reactance, low values of coupling resistance along with peaking coils or other special interstage coupling impedances are usually used to flatten out the gain/frequency and hence the phase/frequency characteristic of the amplifier. Recommended operating conditions along with expressions for calculation of gain and circuit values are given in Figure 28. Only a simple two-terminal interstage coupling network is shown in this figure. The performance and gain-per-stage of such an amplifier can be improved by the use of increasingly complex two-terminal interstage coupling networks or through the use of four-terminal coupling networks or filters between successive stages. The reader is referred to Terman's "Radio Engineer's Handbook" for design data on such interstage coupling networks. A cathode follower is usually employed where it is desired to feed a video-frequency amplifier into a low-impedance load such as a coaxial cable. Cathode followers are discussed in section 4-9.

Radio Receiver Fundamentals

A CONVENTIONAL reproducing device such as a loudspeaker or a pair of headphones is incapable of receiving directly the intelligence carried by the "carrier" wave of a radio transmitting station. It is necessary that an additional device, called a *radio receiver*, be placed between the receiving antenna and the loudspeaker or headphones.

Radio receivers vary widely in their complexity and basic design, depending upon the intended application and upon economic factors. A simple radio receiver for reception of radiotelephone signals can consist of an earphone, a silicon or germanium crystal as a carrier rectifier or *demodulator*, and a length of wire as an antenna. However, such a receiver is highly insensitive, and offers no significant discrimination between two signals in the same portion of the spectrum.

On the other hand, a dual-diversity receiver designed for single-sideband reception and employing double or triple detection might occupy several relay racks and would cost many thousands of dollars. However, conventional communications receivers are intermediate in complexity and performance between the two extremes. This chapter is devoted to the principles underlying the operation of such conventional communications receivers.

5-1 Detection or Demodulation

A detector or demodulator is a device for removing the modulation (demodulating) or detecting the intelligence carried by an incoming radio wave.

Radiotelephony Demodulation Figure 1 illustrates an elementary form of radiotelephony receiver employing a diode detector. Energy from a passing radio wave will induce a voltage in the antenna and cause a radio-frequency current to flow from antenna to ground through coil L_1 . The alternating magnetic field set up around L_1 links with the turns of L_2 and causes an r-f current to flow through the parallel-tuned circuit, L_2 - C . When variable capacitor C is adjusted so that the tuned circuit is resonant at the frequency of the applied signal, the r-f voltage is maximum, as explained in Chapter 2. This r-f voltage is applied to the diode detector where it is rectified into a pulsating direct current and passed through the earphones. The pulsations in this voltage correspond to the voice modulation placed on the signal at the trans-

mitter. As the earphone diaphragms vibrate back and forth in accordance with the pulsating current they audibly reproduce the modulation which was placed upon the carrier wave.

The operation of the detector circuit is shown graphically above the detector circuit in Figure 1. The modulated carrier is shown at A, as it is applied to the antenna. B represents the same carrier, increased in amplitude, as it appears across the tuned circuit. In C the pulsating d-c output from the detector is seen.

By adding an audio amplifier, as shown in Figure 2A, the output of the receiver may be increased greatly. In 2A, the earphones of Figure 1 have been replaced by a resistor, R , and an r-f by-pass capacitor, C_1 . The audio voltage across R and C_1 is coupled to the grid of a Class A audio amplifier by means of a coupling capacitor C_2 , and the headphones are placed in the plate circuit of the amplifier stage. Grid bias is supplied by a C battery, which is connected to the amplifier grid through a high resistance, R_1 .

To simplify the circuit shown at 2A, the load resistor, R , and its by-pass capacitor may be moved around the circuit until they are in series with the diode plate, instead of its cathode. The voltage across R and C_1 is still pulsating d.c., with the pulsation corresponding to the modulation on the signal, but the d-c voltage at the diode plate is now always negative with respect to ground. Having a negative voltage

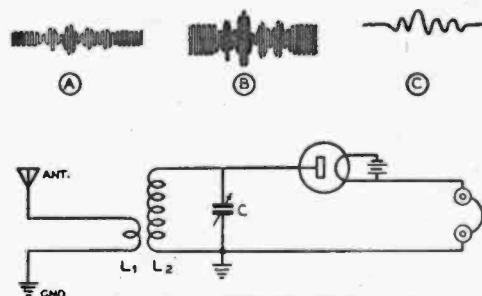

Figure 1.

ELEMENTARY FORM OF RECEIVER.

This diode detector with a single tuned circuit would make a very insensitive receiver, and is shown merely for purposes of illustration. (See text.)

at the diode plate allows the amplifier stage grid to be directly connected to this point, thus dispensing with the bias battery, the grid return resistor R_1 , and coupling capacitor C_1 .

The Grid-Leak Detector Still further simplification of the circuit is shown at 2C, where the triode grid has entirely replaced the diode plate, thus eliminating one tube from the circuit. An r-f by-pass capacitor C_2 has been added to 2C to remove any r.f. which finds its way into the plate circuit. The circuit shown at 2C is known as a *grid leak detector*, and as the above discussion has shown, it is simply a diode detector plus an electron coupled audio amplifier, both combined in a single tube. The grid-leak detector is not limited to triodes; tetrodes or pentodes may also be used, these generally having greater sensitivity than the triodes.

There are many types of detectors, but they all consist of a non-linear device which serves as a *rectifier*, to convert the envelope of the inaudible radio frequency oscillations into usable signal voltages.

Radiotelegraphy Reception Since a c.w. telegraphy signal consists of an unmodulated carrier which is interrupted to form dots and dashes, it is apparent that such a signal would not be made audible by detection alone. While the keying is a form of modulation, it is composed of such low frequency components that the keying envelope itself is below the audible range for hand keying speeds. Some means must be provided whereby an audible tone is heard while the unmodulated carrier is being received, the tone stopping immediately when the carrier is interrupted.

The most simple means of accomplishing this is to feed a locally generated carrier of a slightly different frequency into the same detector, so that the incoming signal will *mix* with it to form an audible *beat note*. The difference frequency, or *heterodyne* as the beat note is known, will of course stop and start in accordance with the incoming c.w. radiotelegraph signal, because the audible heterodyne can exist only when both the incoming and the locally generated carriers are present.

The Autodyne Detector The local signal which is used to beat with the desired c.w. signal in the detector may be supplied by a separate low-power oscillator in the receiver itself, or the detector may be made to self-oscillate, and thus serve the dual purpose of detector and oscillator. A detector which self-oscillates to provide a beat note is known as an *autodyne* detector, and the process of obtaining feedback between the detector plate and grid is called *regeneration*. A typical autodyne or regenerative detector is shown in Figure 3.

An autodyne detector is most sensitive when it is barely oscillating, and for this reason a regeneration control is always included in the circuit to adjust the feedback to the proper amount. Capacitor C_2 in Figure 3 is the regeneration control. This capacitor serves as a variable plate by-pass capacitor and is commonly called a "throttle condenser."

With the detector regenerative but not oscillating, it is also extremely sensitive. When the circuit is adjusted to operate in this manner, modulated signals may be received with considerably greater strength than with a non-regenerative detector.

The circuit shown in Figure 3 is but one of many regenerative detectors. There are several methods by which regeneration may be obtained, and also several alternative methods of controlling the regeneration. In tubes with an indirectly-heated cathode, regeneration may be obtained by tapping the cathode onto the grid coil a few turns up from the ground end, or by returning the cathode to ground through a coil coupled to the grid winding. With tetrode or pentode tubes, feedback is some-

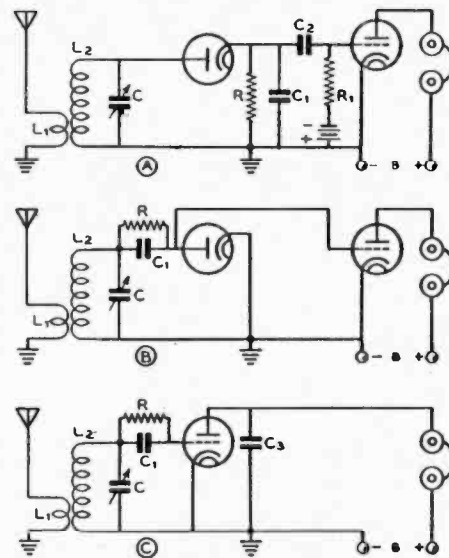
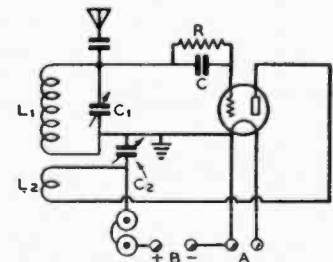

Figure 2. EVOLUTION OF THE GRID LEAK DETECTOR.

Illustrating how a diode detector and triode audio amplifier may have their functions incorporated in a single triode, comprising a grid leak detector.

Figure 3. REGENERATIVE DETECTOR EMPLOYING TRIODE.

The regenerative detector makes the simplest practical high frequency receiver.



times provided by connecting the screen, rather than the plate, to the tickler coil.

Other methods of controlling regeneration vary the voltage on one of the tube elements, usually the plate or screen. Examples of some of the possible variations in regeneration and control methods are shown in Figure 4.

5-2 Superregenerative Receivers

At ultra-high frequencies, when it is desired to keep weight and cost at a minimum, a special form of the regenerative receiver known as the *superregenerator* is often used for radio-telephony reception. The superregenerator is essentially a regenerative receiver with a means provided to throw the detector rapidly in and out of oscillation. The frequency at which the detector is made to go in and out of oscillation varies in different receivers, but is usually between 20,000 and 500,000 times a second. This considerably increases the sensitivity of the oscillating detector so that the usual "background hiss" is greatly amplified when no signal is being received. This hiss diminishes in proportion to the strength of the received signal, loud signals eliminating the hiss entirely.

Quench Methods There are two systems in common use for causing the detector to break in and out of oscillation rapidly. In one, a separate *interruption-frequency* oscillator is arranged so as to vary the voltage rapidly on one of the detector tube elements (usually the plate, sometimes the screen) at the high rate necessary. The interruption-frequency oscillator commonly uses a conventional tickler-feedback circuit with coils appropriate for its operating frequency.

The second, and simplest, type of superregenerative detector circuit is arranged so as to produce its own interruption fre-

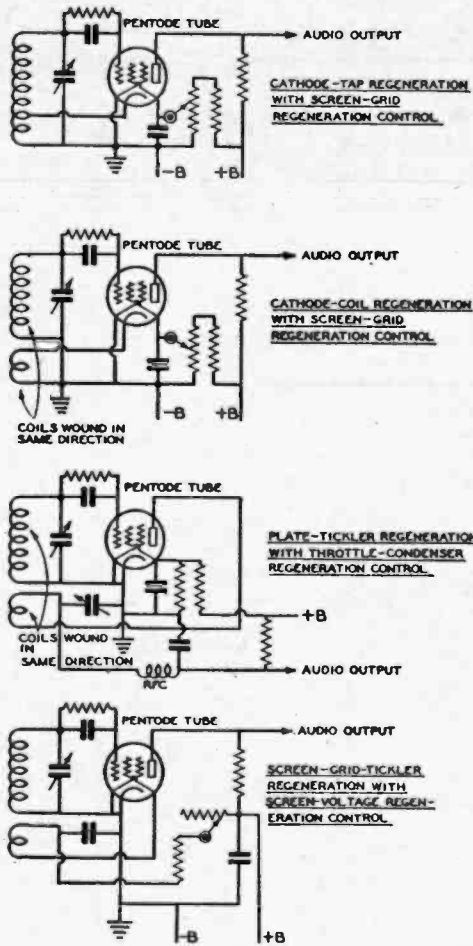

Figure 4.

REGENERATIVE DETECTOR CIRCUITS.

These circuits illustrate some of the more popular regenerative detectors. Values of 1 to 3 megohms for grid leaks are common. The grid capacitor usually has a capacitance of .0001 $\mu\text{fd.}$, while the screen by-pass is 0.1 $\mu\text{fd.}$ Pentode detectors operate best when the feedback is adjusted so that they start to oscillate with from 30 to 50 volts on the screen grid.

quency oscillation, without the aid of a separate tube. The detector tube damps (or "quenches") itself out of signal-frequency oscillation at a high rate by virtue of the use of a high value of grid leak and proper size plate-blocking and grid capacitors, in conjunction with an excess of feedback. In this type of "self-quenched" detector, the grid leak is quite often returned to the positive side of the power supply (through the coil) rather than to the cathode. A representative self-quenched superregenerative detector circuit is shown in Figure 5.

Except where it is impossible to secure sufficient regenerative feedback to permit superregeneration, the self-quenching circuit is to be preferred; it is simpler, is self-adjusting as regards quenching amplitude, and has ideal quenching wave form. To obtain as good results with a separately quenched superregenerator, very careful design and critical circuit operation are required. However, separately quenched circuits are useful when it is possible to make a certain tube oscillate on a very high frequency but impossible to obtain enough regeneration for self-quenching action.

The optimum quenching frequency is a function of the signal frequency. As the operating frequency goes up, so does the optimum quenching frequency. When the quench frequency is too low, maximum sensitivity is not obtained. When it is too high, both sensitivity and selectivity suffer. In fact, the optimum quench frequency for an operating frequency

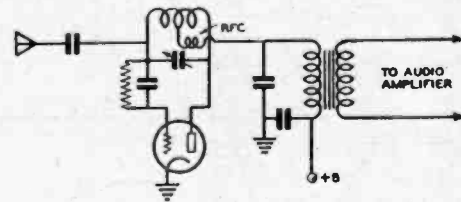

Figure 5.

SUPERREGENERATIVE DETECTOR.

A self-quenched superregenerative detector such as that illustrated here is about as sensitive as any ultra high frequency receiver that can be built. It has the further advantage of inherent a.v.c. action, but the disadvantage that it will radiate a strong, rough signal unless a well shielded r.f. stage is used ahead of it.

below 15 Mc. is in the audible range. This makes the superregenerator a mediocre performer on low frequencies, because it is not feasible to have the quench in the audible range.

The high background noise or hiss which is heard on a properly designed superregenerator when no signal is being received is not the quench frequency component "leaking through"; it is tube and tuned circuit fluctuation noise, indicating that the receiver is extremely sensitive.

A moderately strong signal will cause the background noise to disappear completely, because the superregenerator has an inherent and instantaneous automatic volume control characteristic. This same a.v.c. characteristic makes the receiver comparatively insensitive to impulse noise such as ignition pulses, a highly desirable feature. This characteristic also results in appreciable distortion of the received radiotelephony signal, but not enough to affect the intelligibility seriously.

The selectivity of a superregenerator is rather poor as compared to a superheterodyne, but is excellent for so simple a receiver when figured on a percentage basis rather than absolute kc. bandwidth.

FM Reception

A superregenerative receiver will receive frequency modulated signals with results comparing favorably with amplitude modulation if the frequency swing of the FM transmitter is sufficiently high. For such reception, the receiver is detuned slightly from either side of resonance.

Superregenerative receivers radiate a strong, broad, and rough signal. For this reason it is necessary in most applications to employ a radio frequency amplifier stage ahead of the detector, with thorough shielding and bypassing throughout the receiver.

Practical superregenerative receiver circuits, along with a further discussion of their operation, will be found in Chapter 20.

5-3 Superheterodyne Receivers

Because of its superiority and nearly universal use in all fields of radio reception, the theory of operation of the superheterodyne should be familiar to every radio student and experimenter. The following discussion concerns superheterodynes for amplitude-modulation reception. It is, however, applicable in part to receivers for frequency modulation. The points of difference between the two types of receivers, together with circuits required for FM reception, will be found in Chapter 8.

Principle of Operation

In the superheterodyne, the incoming signal is applied to a *mixer* consisting of a non-linear impedance such as an overbiased vacuum tube or a diode. The signal is mixed with a steady signal generated locally in an oscillator stage, with the result that a signal bearing all the modulation applied to the original signal *but of a frequency equal to the difference between the local oscil-*

Figure 6.
ESSENTIAL UNITS OF A SUPERHETERODYNE.

The basic portions of the circuit are shown solid. Practicable receivers employ one or more of the dotted units in addition to the basic units, and a really good communications receiver employs them all.

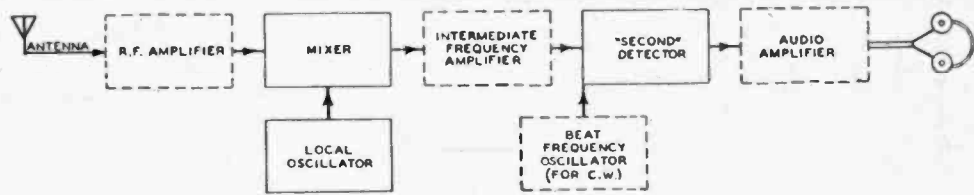

lator and incoming signal frequencies appears in the mixer output circuit. The output from the mixer stage is fed into a fixed-tune intermediate-frequency amplifier, where it is amplified and detected in the usual manner, and passed on to the audio amplifier. Figure 6 shows a block diagram of the fundamental superheterodyne arrangement. The basic components are shown in heavy lines, the simplest superheterodyne consisting simply of these three units. However, a good communications receiver will comprise all of the elements shown, both heavy and dotted blocks.

Superheterodyne Advantages The advantages of superheterodyne reception are directly attributable to the use of the fixed-tune intermediate-frequency (i-f) amplifier. Since all signals are converted to the intermediate frequency, this section of the receiver may be designed for optimum selectivity and amplification. High amplification is easily obtained in the intermediate-frequency amplifier, since it operates at a relatively low frequency, where conventional pentode-type tubes give a great deal of voltage gain. A typical i-f amplifier stage is shown in Figure 7.

From the diagram it may be seen that both the grid and plate circuits are tuned. Tuning both circuits in this way is advantageous in two ways; it increases the selectivity, and it allows the tubes to work into a high-impedance resonant plate load, a very desirable condition where high gain is desired. The tuned circuits used for coupling between i-f stages are known as *i-f transformers*. These will be more fully discussed later in this chapter.

Choice of Intermediate Frequency The choice of a frequency for the i-f amplifier involves several considerations. One of these considerations is in the matter of selectivity; the lower the intermediate frequency the greater the obtainable selectivity. On the other hand, a rather high intermediate frequency is desirable from the standpoint of image elimination, and also for the reception of signals from television and FM transmitters and modulated self-controlled oscillators, all of which occupy a rather wide band of frequencies, making a broad selectivity characteristic desirable. Images are a peculiarity common to all superheterodyne receivers, and for this reason they are given a detailed discussion later in this chapter.

While intermediate frequencies as low as 30 kc. were common at one time, and frequencies as high as 60 Mc. are used in some specialized forms of receivers, most present-day communications superheterodynes nearly always use intermediate frequencies around either 455 kc. or 1600 kc. Frequencies sometimes encountered in the older broadcast-band receivers are 175 kc. and 262 kc. Modern broadcast receivers usually employ an i.f. around 455 kc.

Generally speaking, it may be said that for maximum selectivity consistent with a reasonable amount of image rejection for signal frequencies up to 30 Mc., intermediate frequencies in the 450-470 kc. range are used, while for a good compromise between image rejection and selectivity, 1600 kc. is used. For the reception of both amplitude and frequency modulated signals above 30 Mc., intermediate frequencies near 3, 4.3, 5.3, and 10.7 Mc. are often used.

Arithmetical Selectivity Aside from allowing the use of fixed-tune band-pass amplifier stages, the superheterodyne has an overwhelming advantage over the t.r.f. type of receiver because of what is commonly known as *arithmetical selectivity*.

This can best be illustrated by considering two receivers, one of the t.r.f. type and one of the superheterodyne type, both attempting to receive a desired signal at 10,000 kc. and eliminate a strong interfering signal at 10,010 kc. In the t.r.f. receiver, separating these two signals in the tuning circuits is practically impossible, since they differ in frequency by only 0.1 per cent. However, in a superheterodyne with an intermediate frequency of, for example, 1000 kc., the desired signal will be converted to a frequency of 1000 kc. and the interfering signal will be converted to a frequency of 1010 kc., both signals appearing at the input of the i-f amplifier. In this case, the two signals may be separated much more readily, since they differ by 1 per cent, or 10 times as much as in the first case.

Mixer Circuits Of great importance to satisfactory operation of the superheterodyne is the *mixer*. No matter how much signal is applied to the mixer, if the signal is not converted to the intermediate frequency and passed on to the i-f amplifier with a strength greater than the noise level at the i-f input, it is lost. The tube manufacturers have released a variety of special tubes for mixer applications, each having specific advantages.

Figure 8 shows several representative mixer-oscillator circuits. At "A" is illustrated control-grid injection from an electron-coupled oscillator to the mixer. The mixer tube for this type of circuit is usually a sharp-cut-off pentode of the 6SJ7 or similar type. The coupling capacitor C, between the oscillator and mixer is quite small, usually 1 or 2 μfd .

This same circuit may be used with the oscillator output being taken from a triode oscillator grid or cathode. The only disadvantage to this method is that interlocking, or "pulling," between the mixer and oscillator tuning controls is likely to take place. A rather high value of cathode resistor (10,000 to 50,000 ohms) is usually used with this circuit.

Injection of oscillator voltage into mixer elements other than the control grid, is illustrated by B, C, D and E. The cir-

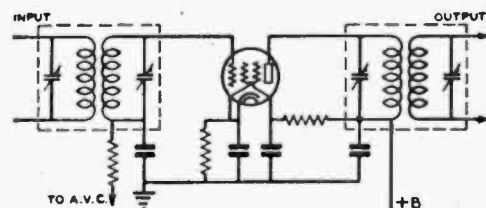

Figure 7.
TYPICAL I.F. AMPLIFIER STAGE.

Variable- μ pentodes are ordinarily used as i.f. amplifier tubes. Most of the ordinary tubes require a cathode resistor of around 300 ohms and a 100,000-ohm screen dropping resistor. The high-transconductance "television" type pentodes usually need less cathode resistance, and values as low as 100 ohms are common. The screen resistor for the "television" types may have a value between 50,000 and 75,000 ohms. By-pass condensers are usually .05 or 0.1- μfd .

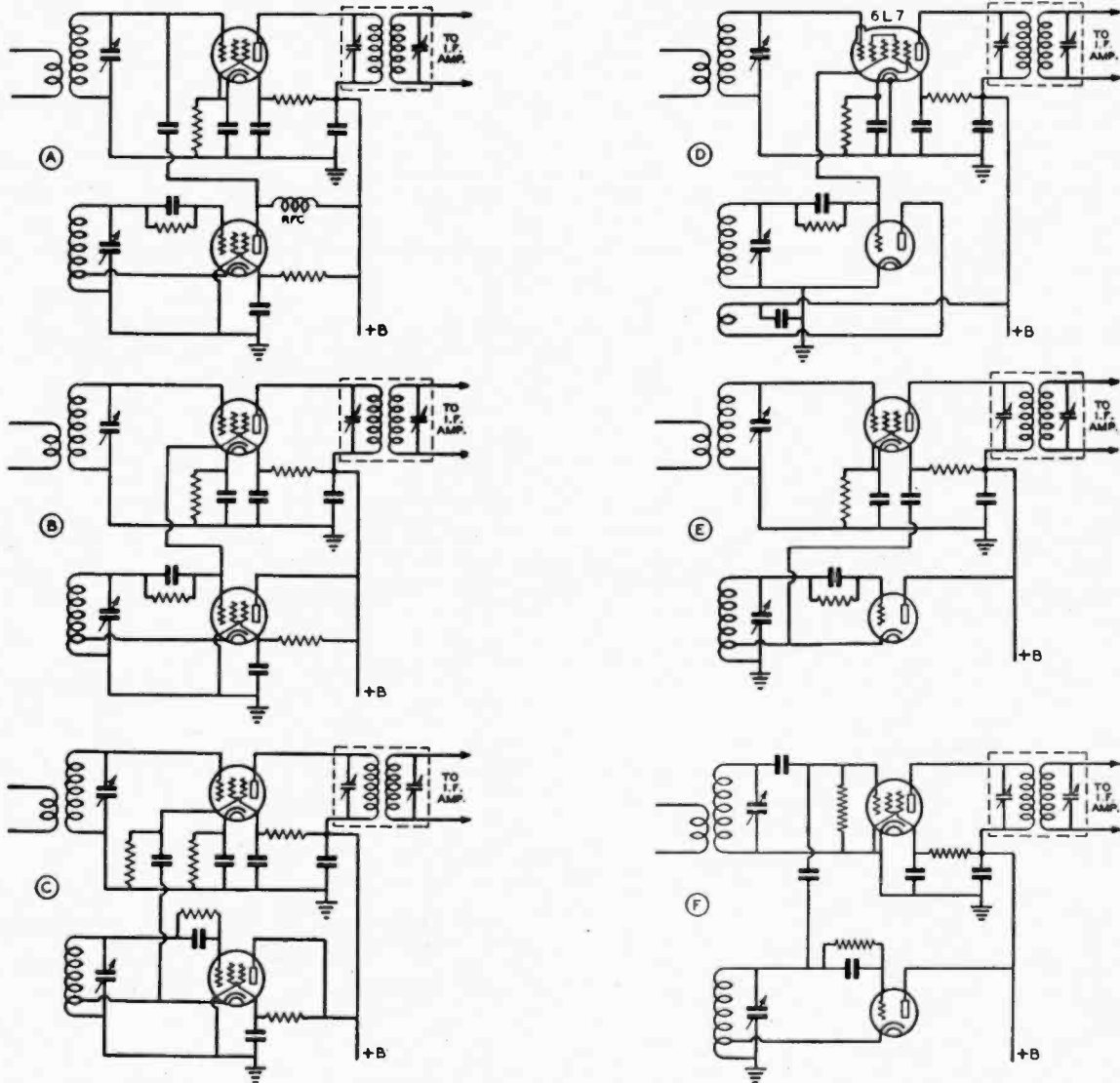

Figure 8.

MIXER-OSCILLATOR COMBINATIONS.

The various oscillators do not have to be used with the mixers with which they happen to be shown. The triode oscillator shown at E could replace the pentode circuit shown at B, for instance.

cuit of B shows injection into the suppressor grid of the mixer tube. The suppressor is biased negatively by connecting it directly to the grid of the oscillator.

An alternative method of obtaining bias for the suppressor, and one which is less prone to cause interlocking between the oscillator and mixer, is shown in C. In this circuit, the suppressor bias is obtained by allowing the rectified suppressor-grid current to flow through a 100,000-ohm resistor to ground. The coupling capacitor between oscillator and mixer may be 50 or 100 μfd . with this circuit. Output from the oscillator may be taken from the cathode instead of the grid end of the coil, as shown, if sufficient oscillator output is available. Mixer cathode resistors having values between 500 and 5000 ohms are ordinarily used with the circuits of B and C.

The mixer circuit shown in D is similar in appearance to that of B. The difference in the two lies in the type of tube used as a mixer. The 6L7 shown in D is especially designed for mixer service. It has a separate, shielded *injector grid*, by means of which voltage from the oscillator may be injected. This circuit permits the same variations as the suppressor-injection system in regard to the method of connection into the oscillator circuit. The 6L7 requires rather high screen voltage

and draws considerable screen current, and, for these reasons, the screen-dropping resistor is usually made around 15,000 ohms.

Screen grid injection is shown at E. This circuit is likely to cause rather bad pulling at high frequencies, as there is no electrostatic shielding within the mixer tube between the screen grid and the mixer and the control grid. A variation of this circuit, in which the pulling effect is reduced considerably, consists of using an electron-coupled oscillator circuit similar to that shown in A and connecting the plate of the oscillator and the screen of the mixer directly together. A voltage of about 100 volts is then applied to both the oscillator plate and the mixer screen.

E.C.O. Harmonics One disadvantage to the use of an electron-coupled type oscillator with the output taken from the plate is that the untuned plate circuit of the e.c. oscillator contains a large amount of harmonic output. Therefore, considerable selectivity must be used ahead of the mixer to prevent the harmonics of the oscillator from beating with undesired signals at higher frequencies and bringing them in along with the desired signal. If it is desired to use an e.c. type oscillator to secure receiver stabilization in regard

to voltage changes, it will usually be found best to take the oscillator output from the tuned grid circuit, where the harmonic content is low. The plate of the oscillator tube may be bypassed directly to ground with this arrangement.

Improved Control-Grid Injection

In F, an improved control grid injection type mixer circuit is shown. This circuit allows peak mixer conversion transconductance under wide variations in oscillator output. The bias on the mixer is automatically maintained at the correct value through the use of grid-leak bias, rather than by cathode bias. The mixer grid leak should have a value of from 3 to 5 megohms. As in the circuit shown at A, the coupling capacitor should be quite small—on the order of 1 or 2 μfd . It is absolutely essential that a rather high value of series screen dropping resistor be used with this circuit to limit the current drawn by the mixer tube in case the oscillator injection voltage (and consequently the mixer bias) is inadvertently removed. The value of the screen resistor will probably lie around 100,000 ohms or above, depending upon the type of mixer tube and the available plate voltage. The resistor value should be determined experimentally by using a value which limits the mixer cathode current when the oscillator is not operating to the maximum permissible current specified by the tube manufacturer.

The different oscillator circuits shown in Figure 8 are not necessarily limited to use with the mixers with which they happen to be shown. Almost any oscillator arrangement may be used with a particular mixer circuit. Examples of some of the possible combinations will be found in Chapter 18.

Triode Mixers A triode having a high transconductance is the quietest mixer tube, exhibiting somewhat less gain but a better signal-to-noise ratio than a comparable multi-grid mixer tube. However, below 30 Mc. it is possible to construct a receiver that will get down to the atmospheric noise level without resorting to a triode mixer, and the additional difficulties experienced in avoiding "pulling", undesirable feedback, etc., a triode with control-grid injection to make multi-grid tubes the popular choice for this application on the lower frequencies.

On very high frequencies, where set noise rather than atmospheric noise limits the weak signal response, triode mixers are more widely used. A 6J6 miniature twin triode with grids in push-pull and plates in parallel makes an excellent mixer up to about 600 Mc.

Injection Voltage The amplitude of the injection voltage will affect the conversion transconductance of the mixer, and therefore should be made optimum if maximum gain is desired. If fixed bias is employed on the injection grid, the optimum injection voltage is quite critical. If cathode bias is used, the optimum voltage is not so critical; and if grid leak bias is employed, the optimum injection voltage is not at all critical just so it is adequate. Typical optimum injection voltages will run from 1 to 10 volts for control grid injection, and 45 volts or so for screen or suppressor grid injection.

"Converter" Tubes There is a series of converter tubes available in which the functions of the oscillator and mixer are combined in a single tube. Typical of these tubes are the 6A7, 6A8, 6SA7, and 6SB7-Y. The term *pentagrid* has been applied to these tubes because they have 5 grids, one of the extra grids being used as grid and the other as the anode for the oscillator section of the circuit. Suitable circuits for use with these tubes are shown in Figures 9A and 9B. Generally speaking, the use of such tubes is not recommended in high performance, high frequency receivers.

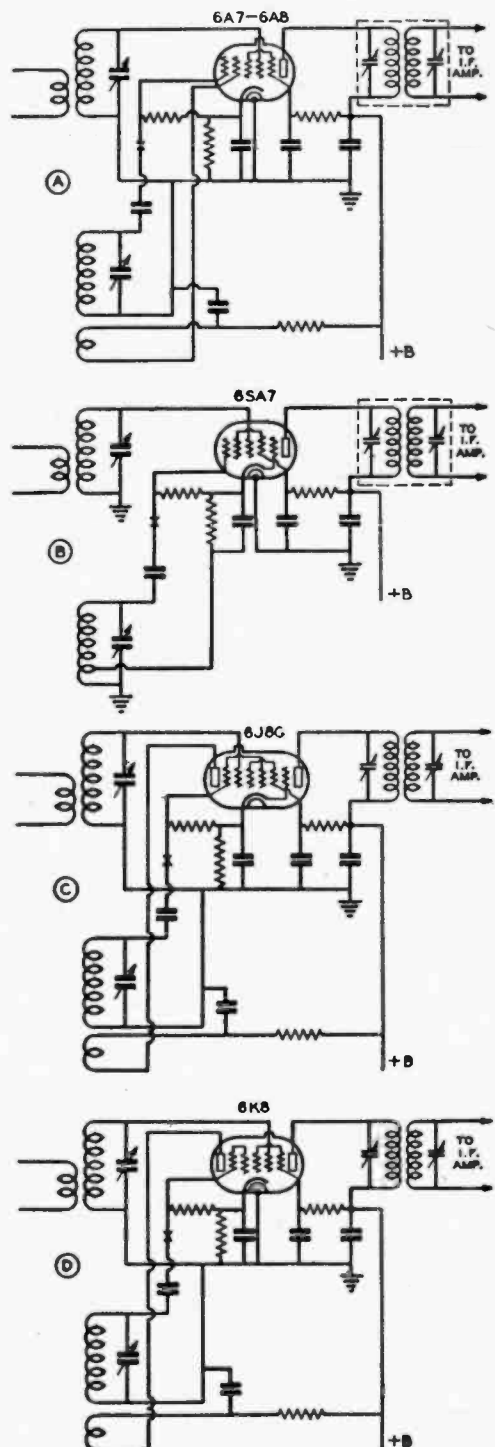

Figure 9. CONVERTER CIRCUITS.

A and B are for "pentagrid" tubes, and C and D are for "triode-heptode" and "triode-hexode" tubes. The points marked "X" show where injection from a separate oscillator may be introduced.

Another set of combination tubes known as *triode-heptodes* and *triode-hexodes* is also available for use as combination mixers and oscillators. These tubes are exemplified by the 6J8G and the 6K8; they get their name from the fact that they contain two separate sets of elements—a triode and a heptode in one case, and a triode and a hexode in the other. Representative circuits for both types are shown at 9C and 9D.

Certain of the combination mixer-oscillator tubes make good

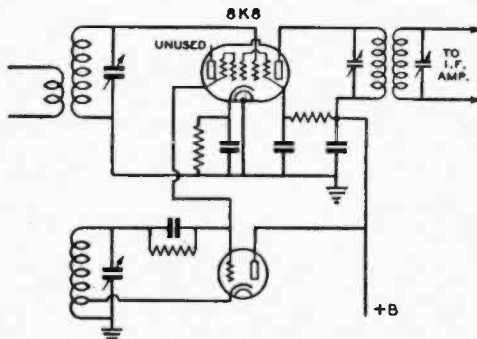

Figure 10.
DUAL PURPOSE CONVERTER TUBE WITH SEPARATE OSCILLATOR.

The performance of certain "combination" converter tubes can be improved, especially at high frequencies, by employing a separate oscillator for injection. The points "X" in figure 9 show where a separate oscillator may be connected with each of the tubes shown.

high frequency mixers when their oscillator section is left unused and the oscillator section grid is connected to a separate oscillator capable of high output. The 6K8, 6J8G and 6SA7 perform particularly well when used in this manner. A circuit of this type for use with a 6K8 is shown in Figure 10. The points marked "X" in Figure 9 show the proper place to inject r-f from a separate oscillator with the other combination type converter tubes. When the 6A7 and 6A8 types are used with a separate oscillator, the unused oscillator anode-grid is connected directly to the screen.

Diode Mixers As the frequency of operation of a superheterodyne receiver is increased above a few hundred megacycles the signal-to-noise ratio appearing in the plate circuit of the mixer tube when triodes or pentodes are employed drops to a prohibitively low value. At frequencies above the upper-frequency limit for conventional mixer stages, mixers of the diode type are most commonly employed. The diode may be either a vacuum-tube heater diode of a special u-h-f design such as the 9005, or it may be a crystal diode of the general type of the 1N21 through 1N28 series. Circuits and operating principles of diode mixers are discussed in more detail in Section 5-9 of this chapter.

5-4 Mixer Noise and Images

The effects of *mixer noise* and *images* are troubles common to all superheterodynes. Since both these effects can largely be obviated by the same remedy, they will be considered together.

Mixer Noise Mixer noise of the shot-effect type, which is evidenced by a hiss in the audio output of the receiver, is caused by small irregularities in the plate current in the mixer stage and will mask weak signals. Noise of an identical nature is generated in an amplifier stage, but due to the fact that the conductance in the mixer stage is considerably lower than in an amplifier stage using the same tube, the proportion of inherent noise present in a mixer usually is considerably greater than in an amplifier stage using a comparable tube.

Although this noise cannot be eliminated, its effects can be greatly minimized by placing sufficient signal-frequency amplification having a high signal-to-noise ratio ahead of the mixer. This remedy causes the signal output from the mixer to be large in proportion to the noise generated in the mixer stage. Increasing the gain *after* the mixer will be of no advantage in eliminating mixer noise difficulties; greater selectivity after the mixer will help to a certain extent, but cannot be carried

too far, since this type of selectivity decreases the i-f band-pass and if carried too far will not pass the sidebands that are an essential part of a voice-modulated signal.

Images There always are *two* signal frequencies which will combine with a given frequency to produce the same difference frequency. For example: assume a superheterodyne with its oscillator operating on a higher frequency than the signal, which is common practice in present superheterodynes, tuned to receive a signal at 14,100 kc. Assuming an i-f-amplifier frequency of 450 kc., the mixer input circuit will be tuned to 14,100 kc., and the oscillator to 14,100 plus 450, or 14,550 kc. Now, a *strong* signal at the oscillator frequency plus the intermediate frequency (14,550 plus 450, or 15,000 kc.) will also give a difference frequency of 450 kc. in the mixer output and will be heard also. Note that the image is always *twice* the intermediate frequency away from the desired signal. Images cause "repeat points" on the tuning dial.

The only way that the image could be eliminated in this particular case would be to make the selectivity of the mixer input circuit, and any circuits preceding it, great enough so that the 15,000-kc. signal never reaches the mixer grid in sufficient amplitude to produce interference.

For any particular intermediate frequency, image interference troubles become increasingly greater as the frequency to which the signal-frequency portion of the receiver is tuned is increased. This is due to the fact that the percentage difference between the desired frequency and the image frequency decreases as the receiver is tuned to a higher frequency. The ratio of strength between a signal at the image frequency and a signal at the frequency to which the receiver is tuned producing equal output is known as the *image ratio*. The higher this ratio, the better the receiver in regard to image-interference troubles.

With but a single tuned circuit between the mixer grid and the antenna, and with 400-500 kc. i-f amplifiers, image ratios of 60 db and over are easily obtainable up to frequencies around 2000 kc. Above this frequency, greater selectivity in the mixer grid circuit through the use of additional tuned circuits between the mixer and the antenna is necessary if a good image ratio is to be maintained.

R-F Stages Since the necessary tuned circuits between the mixer and the antenna can be combined with tubes to form r-f amplifier stages, the reduction of the effects of mixer noise and the increasing of the image ratio can be accomplished in a single section of the receiver. When incorporated in the receiver, this section is known simply as an *r-f amplifier*; when it is a separate unit with a separate tuning control it is often known as a *preselector*. Either one or two stages are commonly used in the preselector or r-f amplifier. Some preselectors use regeneration to obtain still greater amplification and selectivity. An r-f amplifier or preselector embodying more than two stages rarely ever is employed since two stages will ordinarily give adequate gain to override mixer noise.

The amplification obtained in an r-f stage depends upon the type of circuit which is used; if the plate load impedance can be made very high, the gain may be as much as 200 or 300 times. Normal values of gain in the broadcast band are in the vicinity of 50 times. A gain of 30 per r-f stage is considered excellent for shortwave receivers in the range 3 to 10 Mc. Radio-frequency amplifiers for the range 10 to 50 Mc. seldom provide a gain of more than 10 times, because of the difficulty in obtaining high load impedances (due largely to the shunt effect of most tubes). A typical r-f amplifier is illustrated in Figure 11.

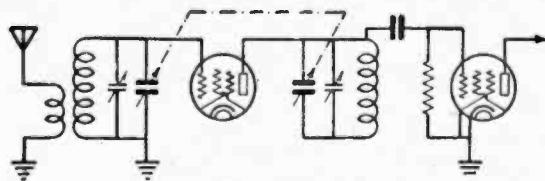

Figure 11.
TYPICAL RADIO FREQUENCY AMPLIFIER.

Regenerative R-F Stages In low cost receivers, and in those where maximum performance with a minimum number of stages is desired, controlled regeneration in an r-f stage is often used. The regenerative r-f amplifier increases amplification and selectivity in a manner similar to that of the regenerative detector. The regenerative r-f amplifier is never allowed to oscillate, however; the greatest amplification is obtained with the circuit operating just below the point of oscillation. Figure 12 shows a regenerative r-f stage of the type generally used on the higher frequencies. This is a special adaptation of the familiar electron-coupled oscillator circuit.

One minor disadvantage of the regenerative r-f stage is the need for an additional control for regeneration. A more important disadvantage is that, due to the high degree of selectivity obtainable with the regenerative stage, it is usually impossible to secure accurate enough tracking between its tuning circuit and the other tuning circuits in the receiver to make single-dial control feasible. Where single-dial control is desired, a small "trimmer" capacitor is usually provided across the main r-f-stage tuning capacitor. By making this capacitor controllable from the front panel, it is possible to compensate manually for slight inaccuracies in the tracking.

Double Conversion As previously mentioned, the use of a higher intermediate frequency will also improve the image ratio, at the expense of i-f selectivity, by placing the desired signal and the image farther apart. To give both good image ratio at the higher frequencies and good selectivity in the i-f amplifier, a system known as *double conversion* is sometimes employed. In this system, the incoming signal is first converted to a rather high intermediate frequency, and then amplified and again converted, this time to a much lower frequency. The first intermediate frequency supplies the necessary wide separation between the image and the desired signal, while the second one supplies the bulk of the i-f selectivity.

When properly designed, a receiver of this type is capable of excellent performance, but such an equipment is quite complex and subject to various "birdies" and spurious responses unless especial care is taken in the design to avoid such difficulties.

Regenerative Preselectors R-f amplifiers for frequencies below 20 Mc. can be made to operate efficiently in a non-regenerative condition. The amplification and selectivity are ample over this range. For higher frequencies, on the other hand, *controlled regeneration* in the r-f amplifier is often desirable for the purpose of increasing the gain and selectivity.

A disadvantage of the regenerative r-f amplifier is the need for an additional (regeneration) control, and the difficulty of maintaining alignment between this circuit and the following tuned circuits. Resonant effects of antenna systems usually must be taken into account; a variable antenna coupling device can sometimes be used to compensate for this effect, however.

The reason for using regeneration in certain cases at the higher frequencies and not at the medium and low frequencies

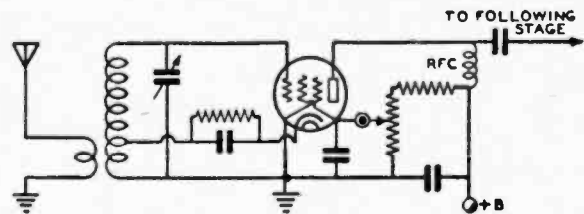

Figure 12.
REGENERATIVE R.F. AMPLIFIER.

The use of regeneration in the r.f. amplifier allows greater amplification to be obtained, particularly at the higher frequencies where tubes and tuned circuits begin to show poor performance in conventional circuits.

can be explained as follows: The signal-to-noise ratio (output signal) of the average r-f amplifier (one not specifically designed for u.h.f.) is not made higher by the incorporation of regeneration. But the signal-to-noise ratio of the receiver as a whole is improved at the very high frequencies because of the extra gain provided ahead of the mixer, this extra gain tending to make the signal output a larger portion of the total signal-plus-noise output of the receiver. At low frequencies an r-f stage has sufficient gain to do this without resorting to regeneration.

5-5 Signal-Frequency Tuned Circuits

The signal-frequency tuned circuits in high-frequency superheterodynes and tuned radio frequency types of receivers consist of coils of either the solenoid or universal-wound types shunted by variable capacitors. It is in these tuned circuits that the causes of success or failure of a receiver often lie. The universal-wound type coils usually are used at frequencies below 2000 kc.; above this frequency the single-layer solenoid type of coil is more satisfactory.

Impedance and Q The two factors of greatest significance in determining the gain-per-stage and selectivity, respectively, of a tuned amplifier are tuned-circuit impedance and tuned-circuit Q. As explained in Chapter 2, Q is the ratio of reactance to resistance in the circuit. Since the resistance of modern capacitors is low at ordinary frequencies, the resistance usually can be considered to be concentrated in the coil. The resistance to be considered in making Q determinations is the r.f. resistance, not the d-c resistance of the wire in the coil. The latter ordinarily is low enough that it may be neglected. The increase in r-f resistance over d-c resistance primarily is due to skin effect and is influenced by such factors as wire size and type, and the proximity of metallic objects or poor insulators, such as coil forms with high losses.

It may be seen from the curves shown in Chapter 2 that higher values of Q lead to better selectivity and increased r-f voltage across the tuned circuit. The increase in voltage is due to an increase in the circuit impedance with the higher values of Q.

Frequently it is possible to secure an increase in impedance in a resonant circuit, and consequently an increase in gain from an amplifier stage, by increasing the reactance through the use of larger coils and smaller tuning capacitors (higher L/C ratio).

Input Resistance Another factor which influences the operation of tuned circuits is the input resistance of the tubes placed across these circuits. At broadcast frequencies, the input resistance of most conventional r-f amplifier tubes is high enough so that it is not bothersome. But as the frequency is increased, the input resistance becomes lower

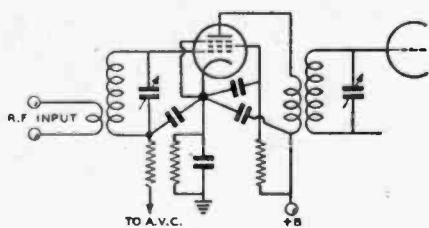

Figure 13.

BY-PASSING IN HIGH FREQUENCY STAGES.

To reduce the effects of common cathode lead inductance, which is detrimental at the higher frequencies, all by-pass capacitors should be returned directly to the cathode terminal of the socket. Tubes with two cathode leads give improved performance; the grid return is made to one lead and the screen and plate returns to the other.

and lower, until it ultimately reaches a value so low that no amplification can be obtained from the r-f stage.

The two contributing factors to the decrease in input resistance with increasing frequency are the transit time required by an electron traveling between the cathode and grid, and the inductance of the cathode lead common to both the plate and grid circuits. As the frequency becomes higher, the transit time can become an appreciable portion of the time required by an r-f cycle of the signal voltage, and current will actually flow into the grid even though it is biased negatively. The result of this effect is similar to that which would be obtained by placing a resistance between the tube's grid and cathode.

Since the input resistance of conventional broadcast receiver tubes can reach rather low values at frequencies above 20 Mc. or thereabouts, there is often no practical advantage to be realized by going to great pains to design a very high impedance tuned circuit for these frequencies, and then shunting it with the tube's input resistance. At any given frequency the tube input resistance remains constant, regardless of what is done to the tuned circuit, and increasing the tuned-circuit impedance beyond twice the input resistance will have but little effect on the net grid-to-ground impedance of the amplifier stage.

The limiting factor in r-f stage gain is the ratio of input conductance to the tube transconductance. When the input conductance becomes so great that it equals the transconductance, the tube no longer can act as an amplifier. One of the ways of increasing the ratio of transconductance to input conductance is exemplified by the "acorn" and "miniature" type tubes, such as the 956, 6AK5, etc., in which the input conductance is reduced through the use of a smaller element structure while the transconductance remains nearly as high as that of tubes ordinarily used at lower frequencies. Another method of accomplishing an increase in transconductance to input conductance ratio is by greatly increasing the transconductance at the expense of a smaller increase in input conductance. The latter method is exemplified by the so-called "television pentodes" such as the 6AC7, which have extremely high transconductance and an input conductance several times that of the acorn tubes.

An increase in transconductance/input conductance ratio is obtained in certain u.h.f. tubes such as the 6SH7 and 6AK5 by the use of separate cathode leads for the grid and plate returns. By this means, the inductance common to both circuits may be held to a minimum, and the input conductance thus decreased.

With conventional tubes having a single cathode terminal, the only control the constructor has over the input resistance is through eliminating, so far as possible, the cathode lead inductance common to the input and output circuits. This means that all by-pass capacitors associated with a tube should be connected separately and directly to the socket cathode

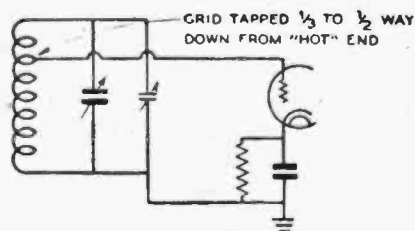

Figure 14.

REDUCING GRID-LOADING EFFECTS.

By tapping the grid down on the coil, as shown, the selectivity may be increased when high input conductance tubes are used at high frequencies.

terminal. The ground connection for the stage may be made by a single capacitor from the cathode to chassis. A typical circuit is shown in Figure 13.

Some of the difficulties presented by input-resistance effects may be obviated by tapping the grid down on the coil, as shown in Figure 14. Although this circuit does not actually cause any reduction in the tube's input conductance, it does remove some of the loading from the tuned circuit, and thus will improve the selectivity. With a tuned circuit which has a high impedance, there will be no loss in r-f voltage applied to the grid, and the net result of tapping the grid down on the coil will be an improvement in selectivity (and image rejection) without significant loss in stage gain. This circuit is commonly employed with high-transconductance "video" tubes above about 20 Mc.

Superheterodyne Tracking

Because the oscillator in a superheterodyne operates "offset" from the other front end circuits, in some cases it is necessary to

make special provisions to allow the oscillator to track when similar tuning capacitor sections are ganged. The usual method of obtaining good tracking is to operate the oscillator on the high-frequency side of the mixer and use a series "tracking capacitor" to slow down the tuning rate of the oscillator. The oscillator tuning rate must be slower because it covers a smaller range than does the mixer when both are expressed as a percentage of frequency. At frequencies above 7000 kc. and with ordinary intermediate frequencies, the difference in percentage between the two tuning ranges is so small that it may be disregarded in receivers designed to cover only a small range, such as an amateur band.

A mixer and oscillator tuning arrangement in which a series tracking capacitor is provided is shown in Figure 15. The value of the tracking capacitor varies considerably with different intermediate frequencies and tuning ranges, capacitances as low as .0001 μ fd. being used at the lower tuning-range frequencies, and values up to .01 μ fd. being used at the higher frequencies.

Bandspread Tuning

The frequency to which a receiver responds may be varied by changing the size of either the coils or the capacitors in the tuning circuits, or both. In short-wave receivers a combination of both methods is usually employed, the coils being changed from one band to another, and variable capacitors being used to tune the receiver across each band. In practical receivers, coils may be changed by one of two methods: a switch, controllable from the panel, may be used to switch coils of different sizes into the tuning circuits or, alternatively, coils of different sizes may be plugged manually into the receiver, the connection into the tuning circuits being made by suitable plugs on the coils. Where there are several "plug-in" coils for each band, they are sometimes arranged to a single mounting strip, allowing them all to be plugged in simultaneously.

In receivers using large tuning capacitors to cover the short-wave spectrum with a minimum of coils, tuning is likely to be quite difficult, owing to the large frequency range covered by a small rotation of the variable capacitors. To alleviate this condition, some method of slowing down the tuning rate, or *bandspreading*, must be used.

Quantitatively, bandspread is usually designated as being inversely proportional to the range covered. Thus, a *large* amount of bandspread indicates that a *small* frequency range is covered by the bandspread control. Conversely, a *small* amount of bandspread is taken to mean that a *large* frequency range is covered by the bandspread dial.

Types of Bandspreading systems are of two general types: electrical and mechanical. Mechanical systems are exemplified by high-ratio dials in which the tuning capacitors rotate much more slowly than the dial knob. In this system there is often a separate scale or pointer either connected or geared to the dial knob to facilitate accurate dial readings. However, there is a limit to the amount of mechanical bandspread which can be obtained in an inexpensive dial and capacitor before the speed-reduction unit and capacitor bearings develop backlash and wobble, which make tuning difficult. To overcome this, most receivers employ a combination of electrical and mechanical bandspread. In this system, a moderate reduction in the tuning rate is obtained in the dial, and the rest of the reduction obtained by *electrical bandspreading*.

Parallel Bandspreading In one form of electrical bandspread, two tuning capacitors are used in parallel across each coil, one of rather high capacitance to cover a large tuning range, and another of small capacitance to cover a small range around the frequency to which the large capacitor is set. These capacitors are usually controlled by separate dials or knobs, the large capacitor being known as the *bandsetting* capacitor, and the smaller one being the *bandspread* capacitor. Where there is more than one tuned circuit in the receiver, a bandsetting and a bandspread capacitor are used across *each* coil, and all the capacitors serving in each function are mechanically connected together, or *ganged*, thus allowing a single dial to be used for each purpose, even though there may be several tuned circuits.

Since the tuning range of a tuned circuit is proportional to the ratio of minimum to maximum capacitance across it, a wide variation in the amount of bandspreading is made possible by a proper choice of the two capacitances. The greater the capacitance of the bandsetting capacitor in proportion to the bandspread capacitor, the greater will be the bandspread.

The bandspreading method described above is usually known as the *parallel* system. This system, as applied to a single tuned circuit, is diagrammed in Figure 16A. The large tuning, or bandsetting capacitor, C_B , usually has a maximum capacitance of from 100 to 370 $\mu\text{fd.}$ The bandspread capacitor, C_F , usually has a value of from 10 to 50 $\mu\text{fd.}$ depending upon the design of the receiver. In typical amateur receivers, a bandspread trimmer is built into each plug-in coil.

Dual-Ratio Bandspreading In some manufactured tuning assemblies, a single set of stationary plates (stator) in the tuning capacitor is acted upon by two separate rotors, one of large capacitance for bandsetting and the other of small capacitance for bandspread. Each rotor is operated by a separate dial. This system allows the bandsetting and bandspread functions to be combined in a single tuning-capacitor unit, minimizing stray shunt and feedback capacities.

Sometimes the same dial is used for both bandsetting and bandspreading purposes, the change from one function to the

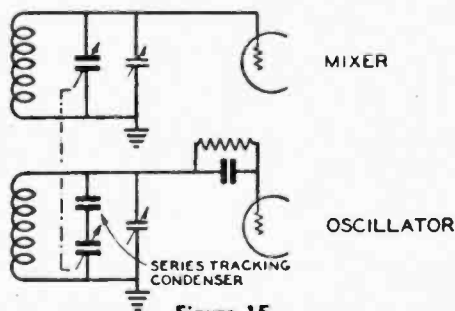

Figure 15.
SERIES TRACKING EMPLOYED IN H.F. OSCILLATOR OF A SUPERHETERODYNE.

The series padder permits use of a gang capacitor with identical gangs, as the padder slows down the rate of capacity change in the oscillator. This assumes "high side" injection.

other being accomplished by a "gear-shifting" mechanism built into the dial. The schematic of this bandspread system is shown in Figure 16B.

The parallel system of bandspreading has one major disadvantage, especially for amateur-band usage. This disadvantage lies in the fact that if the bandspreading capacitor is made large enough to cover the lower-frequency amateur bands with optimum capacitance being used across the coil in the bandsetting capacitor, an extremely large bandsetting-capacitor is needed to give an equal amount of bandspread on the high-frequency bands. The high capacitance across the coils reduces the impedance of the tuned circuits on the high-frequency bands.

Parallel Bandspread Calculations The following formulas will be found useful in designing parallel-bandspread circuits:

$$C_F = \frac{C_B F_L^2}{F_H^2 - F_L^2} \text{ where}$$

- C_F = Capacitance of "bandsetting" capacitor ($\mu\text{fd.}$ or $\mu\text{mfd.}$)
- C_B = Capacitor range of bandspread capacitor (same units as C_F)
- F_L = Low-frequency end of tuning range (kc. or Mc.)
- F_H = High-frequency end of tuning range (same units as F_L)

Where it is desired to know the number of turns to wind on a coil:

$$N = \sqrt{\frac{380,000 (D + 3L) (F_H^2 - F_L^2)}{D^2 C_B F_H^2 F_L^2}}, \text{ where}$$

- N = Number of turns
- D = Diameter of coil, in inches
- L = Length of coil, in inches
- F_H = High-frequency end of tuning range, in megacycles
- F_L = Low-frequency end of tuning range, in megacycles
- C_B = Capacitance range of bandspread capacitor, in $\mu\text{fd.}$

In both the above formulas C_B represents the amount of capacitance variation supplied by the bandspread capacitor. In well-designed midget capacitors, the variation will approach the rated maximum capacity, and the maximum capacitance may be used for C_B without serious error. In the first formula, the result C_F will include all fixed capacitances across the circuit, including the input capacitance of the tube, stray capacitance to ground, and the minimum capacitance of the bandspread capacitor.

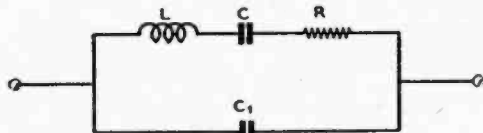

Figure 19.

ELECTRICAL EQUIVALENT OF QUARTZ FILTER CRYSTAL.

The crystal is equivalent to a very large inductance in series with a very small capacitor and resistor, with a larger though still small capacitor across the whole circuit (representing stray capacitance).

much more than 6 db attenuation is required. The attenuation arbitrarily taken to indicate adequate discrimination against an interfering signal is 60 db.

It is apparent that it is desirable to have the band width at 60 db down as narrow as possible, but it must be done without making the pass band (6 db down points) too narrow for satisfactory reception of the desired signal. The figure of merit used to show the ratio of bandwidth at 6 db down to that at 60 db down is designated *shape factor*. The ideal i-f curve, a rectangle, would have a shape factor of 1.0. The i-f shape factor in typical communications receivers runs from 3.0 to 5.5.

The most practicable method of obtaining a low shape factor for a given number of tuned circuits is to employ them in pairs, as in Figure 18A, adjusted to *critical coupling* (the value at which two resonance points just begin to become apparent). If this gives too sharp a "nose" or pass band, then coils of lower Q should be employed, with the coupling maintained at the critical value. As the Q is lowered, closer coupling will be required for critical coupling.

Conversely if the pass band is too broad, coils of higher Q should be employed, the coupling being maintained at critical. If the pass band is made more narrow by using looser coupling instead of raising the Q and maintaining critical coupling, the shape factor will not be as good.

The *pass band* will not be much narrower for several pairs of identical, critically coupled tuned circuits than for a single pair. However, the *shape factor* will be greatly improved as each additional pair is added, up to about 5 pairs, beyond which the improvement for each additional pair is not significant. Commercially available communications receivers of good quality normally employ 3 or 4 double tuned transformers with coupling adjusted to critical or slightly less.

"Miller Effect" As mentioned previously, the dynamic input capacitance of a tube varies slightly with bias. As a-v-c voltage normally is applied to i-f tubes for radio-telephony reception, the effective grid-cathode capacitance varies as the signal strength varies, which produces the same effect as slight detuning of the i-f transformer. This effect is known as "Miller effect", and can be minimized to the extent that it is not troublesome either by using a fairly low L/C ratio in the transformers or by incorporating a small amount of degenerative feedback, the latter being most easily accomplished by leaving part of the cathode resistor unbypassed for r.f.

Crystal Filters The pass band of an intermediate frequency amplifier may be made very narrow through the use of a piezoelectric filter crystal employed as a series resonant circuit in a bridge arrangement known as a *crystal filter*. The shape factor is quite poor, as would be expected when the selectivity is obtained from the equivalent of a single tuned circuit, but the very narrow pass band obtainable as a result of the extremely high Q of the crystal makes the crystal filter useful for c.w. telegraphy reception. The pass band of a 455 kc. crystal filter may be made as narrow as 50 cycles, while 5 kilocycles represent about the narrowest pass band that can

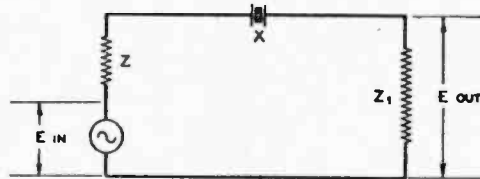

Figure 20.

EQUIVALENT OF CRYSTAL FILTER CIRCUIT.

For a given voltage out of the generator, the voltage developed across Z_1 depends upon the ratio of the impedance of X to the sum of the impedances Z and Z_1 . Because of the high Q of X, its impedance changes rapidly with frequency.

be obtained with a 455 kc. tuned circuit of practicable dimensions.

The electrical equivalent of a filter crystal is shown in Figure 19. For a given frequency, L is very high, C very low, and R (assuming a good crystal of high Q) is very low. Capacitance C_1 represents the shunt capacitance of the electrodes, plus the crystal holder and wiring, and is many times the capacitance of C. This makes a parallel resonant circuit with a frequency only slightly higher than that of the series resonant circuit L, C. For crystal filter use it is the series resonant characteristic that we are primarily interested in.

The electrical equivalent of the basic crystal filter circuit is shown in Figure 20. If the impedance of Z plus Z_1 is low compared to the impedance of the crystal X at resonance, then the current flowing through Z_1 , and the voltage developed across it, will be almost in inverse proportion to the impedance of X, which has a very sharp resonance curve.

If the impedance of Z plus Z_1 is made *high* compared to the resonant impedance of X, then there will be no appreciable drop in voltage across Z_1 as the frequency departs from the resonant frequency of X until the point is reached where the impedance of X approaches that of Z plus Z_1 . This has the effect of broadening out the curve of frequency versus voltage developed across Z_1 , which is another way of saying that the selectivity of the crystal filter (but not the crystal proper) has been reduced.

In practicable filter circuits the impedances Z and Z_1 usually are represented by some form of tuned circuit, but the basic principle of operation is the same.

Practical Filters It is necessary to balance out the capacitance across the crystal holder (C_1 , in Figure 19) to prevent bypassing around the crystal undesired signals off the crystal resonant frequency. The balancing is done by a *phasing* circuit which takes out-of-phase voltage from a balanced input circuit and passes it to the output side of the crystal in proper phase to neutralize that passed through the holder capacitance. A representative practical filter arrangement is shown in Figure 21. The phasing capacitor is indicated in the diagram by PC. The balanced input circuit may be obtained either through the use of a split-stator capacitor as shown, or by the use of a center-tapped input coil.

Variable-Selectivity Filters In the circuit of Figure 21, the selectivity is *minimum* with the crystal input circuit tuned to resonance, since at resonance the impedance of the tuned circuit is maximum. As the input circuit is detuned from resonance, however, the impedance decreases, and the selectivity becomes greater. In this circuit, the output from the crystal filter is tapped down on the i-f stage grid winding to provide a low value of series impedance in the output circuit. It will be recalled that for maximum selectivity, the total impedance in series with the crystal (both input and output circuits) must be low. If one is made low and the other is made variable, then the selectivity may be varied at will from sharp to broad.

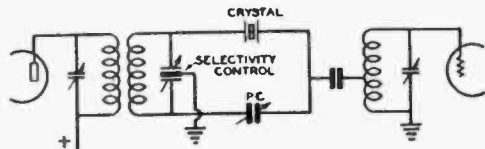

Figure 21.
TYPICAL CRYSTAL FILTER CIRCUIT.

This circuit incorporates a selectivity control and a phasing control to permit maximum exploitation of the filter crystal.

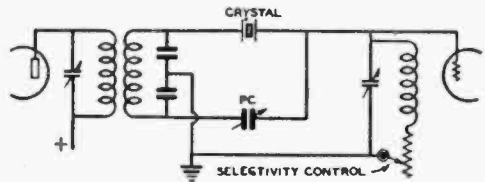

Figure 22.
WIDE RANGE, VARIABLE SELECTIVITY CRYSTAL FILTER.

This circuit permits better selectivity control than the circuit of figure 21, and does not require a split stator variable capacitor.

The circuit shown in Figure 22 also achieves variable selectivity by adding a variable impedance in series with the crystal circuit. In this case, the variable impedance is in series with the crystal output circuit. The impedance of the output tuned circuit is varied by varying the Q. As the Q is reduced (by adding resistance in series with the coil), the impedance decreases and the selectivity becomes greater. The input circuit impedance is made low by using a non-resonant secondary on the input transformer.

A variation of the circuit shown at Figure 22 consists of placing the variable resistance across the coil and capacitor, rather than in series with them. The result of adding the resistor is a reduction of the output impedance, and an increase in selectivity. The circuit behaves oppositely to that of Figure 22, however; as the resistance is lowered the selectivity becomes greater. Still another variation of Figure 22 is to use the tuning capacitor across the output coil to vary the output impedance. As the output circuit is detuned from resonance, its impedance is lowered, and the selectivity increases. Sometimes a set of fixed capacitors and a multipoint switch are used to give step-by-step variation of the output circuit tuning, and thus of the crystal filter selectivity.

Rejection Notch As previously discussed, a filter crystal has both a resonant (series resonant) and an anti-resonant (parallel resonant) frequency, the impedance of the crystal being quite low at the former frequency, and quite high at the latter frequency. The anti-resonant frequency is just slightly higher than the resonant frequency, the difference depending upon the effective shunt capacitance of the filter crystal and holder. As adjustment of the phasing capacitor controls the effective shunt capacitance of the crystal, it is possible to vary the anti-resonant frequency of the crystal slightly without unbalancing the circuit sufficiently to let undesired signals "leak through" the shunt capacitance in appreciable amplitude. At the exact anti-resonant frequency of the crystal the attenuation is exceedingly high, because of the high impedance of the crystal at this frequency. This is called the "rejection notch", and can be utilized virtually to eliminate the heterodyne image or "repeat tuning" of c-w signals. The beat frequency oscillator can be so adjusted and the phasing capacitor so adjusted that the desired beat note is of such a pitch that the image (the same audio note on the other side of zero beat) falls in the rejection notch and is inaudible. The receiver then is said to be adjusted for "single-signal" operation.

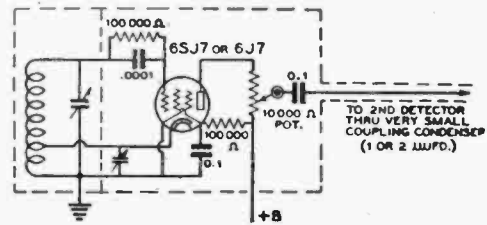

Figure 23.
VARIABLE-OUTPUT B.F.O. CIRCUIT.

Being able to vary the output of the b.f.o. is sometimes helpful when receiving weak signals.

The rejection notch sometimes can be employed to reduce interference from an undesired *phone* signal which is very close in frequency to a desired phone signal. The filter is adjusted to "broad" so as to permit telephony reception, and the receiver tuned so that the carrier frequency of the undesired signal falls in the rejection notch. The modulation sidebands of the undesired signal still will come through, but the carrier heterodyne will be effectively eliminated and interference greatly reduced.

Crystal Filter Considerations A crystal filter, especially when adjusted for "single signal" reception, greatly reduces interference and background noise, the latter feature permitting signals to be copied that would ordinarily be too weak to be heard above the background hiss. However, when the filter is adjusted for maximum selectivity, the pass band is so narrow that the received signal must have a high order of stability in order to stay within the pass band. Likewise, the local oscillator in the receiver must be highly stable, or constant retuning will be required. Another effect that will be noticed with the filter adjusted to "sharp" is a tendency for code characters to produce a ringing sound, and have a hang-over or "tails." This limits the code speed that can be copied satisfactorily when the filter is adjusted for extreme selectivity.

Beat-Frequency Oscillators The beat-frequency oscillator, usually called the *b.f.o.*, is a necessary adjunct for reception of c-w telegraph signals on superheterodynes which do not use regenerative second detectors or which have no other provision for obtaining modulation of an incoming c-w telegraphy signal. The oscillator is coupled into or just ahead of second detector circuit and supplies a signal of nearly the same frequency as that of the desired signal from the i-f amplifier. If the i-f amplifier is tuned to 455 kc., for example, the b.f.o. is tuned to approximately 454 or 456 kc. to produce an audible (1000 cycle) beat note in the output of the second detector of the receiver. The carrier signal itself is, of course, inaudible. The b.f.o. is not used for voice reception, except as an aid in searching for weak stations.

The b.f.o. input to the second detector need only be sufficient to give a good beat note on an average signal. Too much coupling into the second detector will give an excessively high hiss level, masking weak signals by the high noise background.

Figure 23 shows a method of manually adjusting the b.f.o. output to correspond with the strength of received signals. This type of variable b.f.o. output control is a useful adjunct to any superheterodyne, since it allows sufficient b.f.o. output to be obtained to give a "beat" with strong signals and at the same time permits the b.f.o. output, and consequently the hiss, to be reduced when attempting to receive weak signals. The circuit shown is somewhat better than those in which one of the electrode voltages on the b.f.o. tube is changed, as the latter usually change the frequency of the b.f.o. at the same time they change the strength, making it necessary to reset the trimmer each time the output is adjusted.

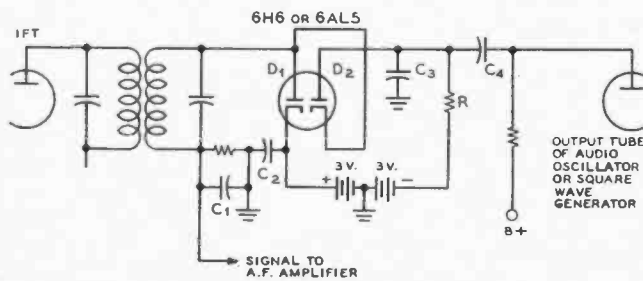

Figure 24.

Circuit showing a method for modulating the c-w output of the second-detector stage in a superheterodyne receiver with an audio tone.

The b.f.o. usually is provided with a small trimmer which is adjustable from the front panel to permit adjustment over a range of 5 or 10 kc. For single-signal reception the b.f.o. always is adjusted to the high-frequency side, in order to permit placing the heterodyne image in the rejection notch.

In order to reduce the b.f.o. signal output voltage to a reasonable level which will prevent blocking the second detector, the signal voltage is delivered through a low-capacitance (high-reactance) capacitor having a value of 1 to 2 $\mu\text{fd.}$ and connected after the 0.1- $\mu\text{fd.}$ unit in Figure 23.

Care must be taken with the b.f.o. to prevent harmonics of the oscillator from being picked up at multiples of the b.f.o. frequency. The complete b.f.o. together with the coupling circuits to the second detector, should be thoroughly shielded to prevent pickup of the harmonics by the input end of the receiver.

If b.f.o. harmonics still have a tendency to give trouble after complete shielding and isolation of the b.f.o. circuit has been accomplished, the passage of these harmonics from the b.f.o. circuit to the rest of the receiver can be stopped through the use of a low-pass filter in the lead between the output of the b.f.o. circuit and the point on the receiver where the b.f.o. signal is to be injected. The design of such filters is discussed in Chapter 2.

C-W Reception Through the Use of Internal Modulation of the Signal

A c-w telegraphy signal can be received without a beat oscillator if the incoming signal is modulated by an audio-frequency tone somewhere along the i-f channel before the second detector

stage. The most satisfactory method is to modulate the control-grid screen, or suppressor bias of the last i-f stage with the audio tone. The signal output of the second detector will then be tone modulated so that an incoming c-w signal will sound as though it were an m-c-w or A2 signal. A still different tone can be obtained if the b.f.o. of the receiver is also turned on and allowed to beat against the already modulated incoming signal.

Audio-Modulated Detection

A circuit has recently been described which accomplishes audio modulation of an incoming c-w signal at the second detector of a superheterodyne receiver. The circuit is diagrammed in Figure 24. A positive delay bias of 2 to 6 volts is placed upon D_1 to limit the minimum signal which will be modulated. Diode D_2 has a negative bias of 2 to 6 volts placed upon it through the 47K resistor and in addition an audio-frequency voltage is applied across this resistor to the second diode. Best operation will be obtained if the a-f voltage is a square wave although a sine-wave may also be used. The circuit gives automatic limiting of incoming c-w signal amplitude, thus affording a degree of noise limiting, and in addition gives a modulated signal output (whenever a signal is being rectified by

the second detector) of a frequency determined by the frequency of the a-f voltage being applied to D_2 . Since the modulating frequency is controllable at the will of the operator, highly selective audio filters may be employed in the audio stages following the second detector. The bias for both diodes may of course be obtained from the power supply of the receiver rather than from batteries as shown.

5-7 Detector, Audio, and Control Circuits

Detectors Second detectors for use in superheterodynes are usually of the diode, plate, or infinite-impedance types. Occasionally, grid-leak detectors are used in receivers using one i-f stage or none at all, in which case the second detector usually is made regenerative.

Diodes are the most popular second detectors because they allow a simple method of obtaining automatic volume control to be used. Diodes load the tuned circuit to which they are connected, however, and thus reduce the selectivity slightly. Special i-f transformers are used for the purpose of providing a low-impedance input circuit to the diode detector.

Automatic Volume Control

The elements of an automatic volume control (a.v.c.) system are shown in Figure 25.

A dual-diode tube is used as a combination diode detector and a.v.c. rectifier. The left-hand diode operates as a simple rectifier in the manner described earlier in this chapter. Audio voltage, superimposed on a d-c voltage, appears across the 500,000-ohm potentiometer (the volume control) and the .0001- $\mu\text{fd.}$ capacitor, and is passed on to the audio amplifier. The right-hand diode receives signal voltage directly from the primary of the last i-f amplifier, and acts as the a.v.c. rectifier. The pulsating d-c voltage across the 1-megohm a.v.c.-diode load resistor is filtered by a 500,000-ohm resistor and a .05- $\mu\text{fd.}$ capacitor, and applied as bias to the grids of the r-f and i-f amplifier tubes; an increase or decrease in signal strength will cause a corresponding increase or decrease in a.v.c. bias voltage, and thus the gain of the receiver is automatically adjusted to compensate for changes in signal strength.

By disassociating the a.v.c. and detecting functions through using separate diodes, as shown, most of the ill effects of a-c shunt loading on the detector diode are avoided. This type of loading causes serious distortion, and the additional components required to eliminate it are well worth their cost. Even with the circuit shown, a-c loading can occur unless a very high (5 megohms, or more) value of grid resistor is used in the following audio amplifier stage.

An a.v.c. circuit which may be added to a receiver not so equipped is shown in Figure 26. In this circuit, the pentode section of a duplex-diode-pentode is used as a resistance coupled i-f amplifier which receives its excitation from the detector grid circuit. The output from the pentode is applied to the two diodes in parallel, through a coupling capacitor, and the rectified voltage across the diode load resistor is used as a.v.c. bias.

A.V.C. in B.F.O.-Equipped Receivers

In receivers having a beat-frequency oscillator for the reception of radiotelegraph signals, the use of a.v.c. can result in a great loss in sensitivity when the b.f.o. is switched on. This is because the beat oscillator output acts exactly like a strong received signal, and causes the a.v.c. circuit to put high bias on the r-f and i-f stages, thus greatly reducing the receiver's sensitivity. Due to the above effect, it is necessary to provide a method of making the a.v.c. circuit inoperative when the b.f.o. is being used. The simplest method of eliminating the a.v.c. action is to short the a.v.c. line to ground when the b.f.o. is turned on. A two-circuit switch may be used for the

Figure 25.
DOUBLE-DIODE DETECTOR-A. V. C. CIRCUIT.

Any of the ordinary small dual-diode tubes may be used in this circuit. The left-hand diode serves as the detector, while the right-hand section operates as an a.v.c. rectifier. Using separate diodes for the detector and a.v.c. functions helps to improve the audio fidelity.

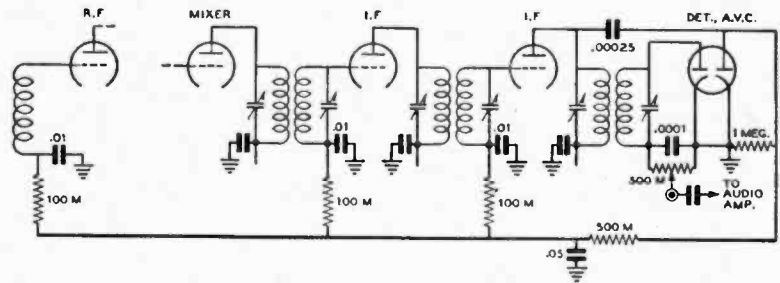

dual purpose of turning on the beat oscillator and shorting out the a.v.c. if desired.

Signal Strength Indicators Visual means for determining whether or not the receiver is properly tuned, as well as an indication of the relative signal strength, are both provided by means of *tuning indicators* (S meters) of the meter or vacuum-tube type. A d-c milliammeter can be connected in the plate supply circuit of one or more r-f or i-f amplifiers, as shown in Figure 27A, so that the change in plate current, due to the action of the a.v.c. voltage, will be indicated on the instrument. The d-c instrument M should have a full-scale reading approximately equal to the total plate current taken by the stage or stages whose plate current passes through the instrument. The value of this current can be estimated by assuming a plate current on each stage (with no signal input to the receiver) of about 6 ma. However, it will be found to be more satisfactory to measure the actual plate current on the stages with a milliammeter of perhaps 0-100 ma. full scale before purchasing an instrument for use as an S meter. The 50-ohm potentiometer shown in the drawing is used to adjust the meter reading to full scale with no signal input to the receiver.

When an ordinary meter is used in the plate circuit of a stage, for the purpose of indicating signal strength, the meter reads backwards with respect to strength. This is because increased a.v.c. bias on stronger signals causes lower plate current through the meter. For this reason, special meters which indicate zero at the right-hand end of the scale are often used for signal strength indicators in commercial receivers using this type of circuit. Alternatively, the meter may be mounted upside down, so that the needle moves toward the right with increased signal strength.

The circuit of Figure 27B can frequently be used to advantage in a receiver where the cathode of one of the r-f or i-f

amplifier stages runs directly to ground through the cathode bias resistor instead of running through a cathode-voltage gain control. In this case a 0-1 d-c milliammeter in conjunction with a resistor from 1000 to 3000 ohms can be used as shown as a signal-strength meter. With this circuit the meter will read backwards with increasing signal strength as in the circuit previously discussed.

Figure 27C is the circuit of a forward-reading S meter as is often used in communications receivers. The instrument is used in an unbalanced bridge circuit with the d-c plate resistance of one i-f tube as one leg of the bridge and with resistors for the other three legs. The value of the resistor R must be determined by trial and error and will be somewhere in the vicinity of 50,000 ohms. Sometimes the screen circuits of the r-f and i-f stages are taken from this point along with the screen-circuit voltage divider.

Electron-ray tubes (sometimes called "magic eyes") can also be used as indicators of relative signal strength in a circuit similar to that shown in Figure 27D. A 6U5/6G5 tube should be used where the a.v.c. voltage will be from 5 to 20 volts and a type 6E5 tube should be used when the a.v.c. voltage will run from 2 to 8 volts.

Audio Amplifiers Audio amplifiers are employed in nearly all radio receivers. The audio amplifier stage or stages are usually of the Class A type, although Class AB push-pull stages are used in some receivers. The operation of both of these types of amplifiers was described in detail in Chapter 4. The purpose of the audio amplifier is to bring the relatively weak signal from the detector up to a strength sufficient to operate a pair of headphones or a loud speaker. Either triodes, pentodes, or beam tetrodes may be used, the pentodes and beam tetrodes usually giving greater output. In some receivers, particularly those employing grid leak detection, it is possible to operate the headphones directly from the detector, without audio amplification. In such receivers, a single audio stage with a beam tetrode or pentode tube is ordinarily used to drive the loud speaker. Representative audio amplifier arrangements will be found in the receivers of Chapters 18 and 20.

Most communications receivers, either home-constructed or factory-made, have a single-ended beam tetrode (such as a 6L6 or 6V6) or pentode (6F6 or 6K6-GT) in the audio output stage feeding the loudspeaker. If precautions are not taken such a stage will actually bring about a decrease in the effective signal-to-noise ratio of the receiver due to the rising high-frequency characteristic of such a stage when feeding a loudspeaker. One way of improving this condition is to place a mica or paper capacitor of approximately 0.003 μ fd. capacitance across the primary of the output transformer. The use of a capacitor in this manner tends to make the load impedance seen by the plate of the output tube more constant over the audio-frequency range. The speaker and transformer will tend to present a rising impedance to the tube as the frequency increases, and the parallel capacitor will tend to present a decreasing impedance with increasing audio frequency.

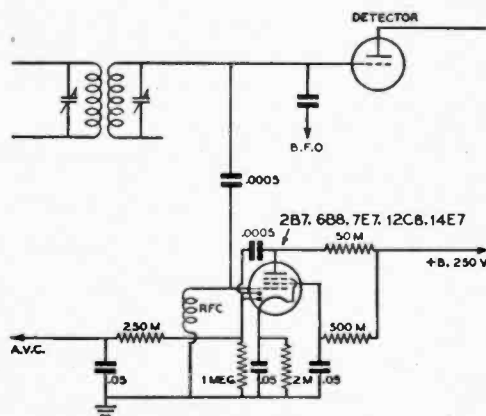

Figure 26.
A.V.C. CIRCUIT SUITABLE FOR ANY SUPERHETERODYNE.

This circuit may be added to a receiver not equipped with a.v.c. The duo-diode-pentode acts as an a.v.c. amplifier, giving improved a.v.c. action.

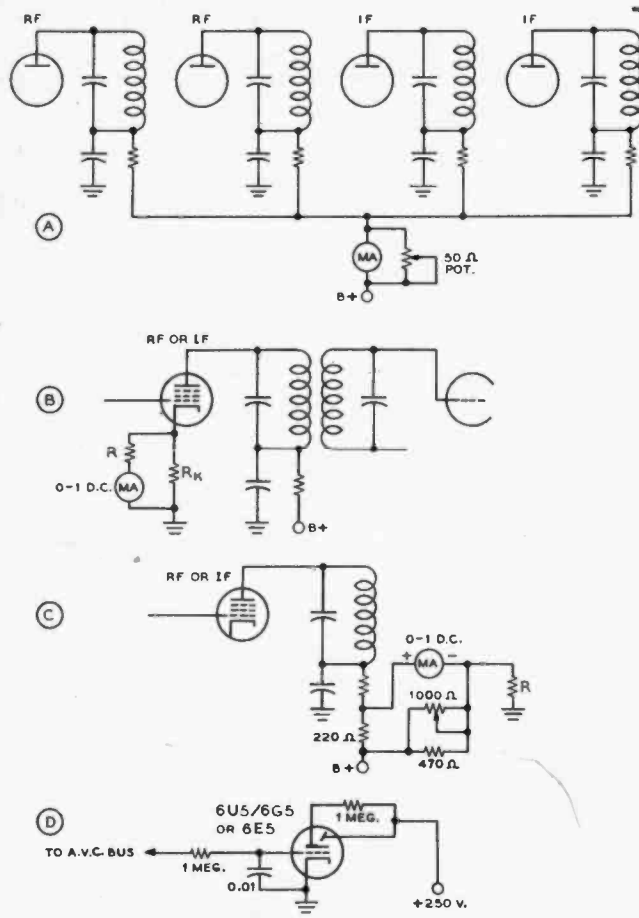

Figure 27.
SIGNAL-STRENGTH-METER CIRCUITS.
Shown above are four circuits for obtaining a signal-strength indication which is proportional to incoming carrier amplitude. Circuits (A), (B), and (C) give indication on a d-c instrument and require no additional tubes. Circuit (D) utilizes an eye tube for strength indication. The circuits are discussed in the text.

A still better way of improving the frequency characteristic of the output stage, and at the same time reducing the harmonic distortion, is to use shunt feedback from the plate of the output tube to the plate of a tube such as a 6SJ7 acting as an audio amplifier stage ahead of the output stage. This circuit is illustrated in Figure 27, Chapter 4, and is used in several of the speech amplifiers described in Chapters 24 and 26.

5-8 Noise Suppression

The problem of noise suppression confronts the listener who is located in places where interference from power lines, electrical appliances, and automobile ignition systems is troublesome. This noise is often of such intensity as to swamp out signals from desired stations.

There are three principal methods for reducing this noise:

- (1) A-c line filters at the source of interference, if the noise is created by an electrical appliance.
- (2) Noise-balancing circuits for the reduction of power-leak interference.
- (3) Noise-limiting circuits for the reduction, in the receiver itself, of interference of the type caused by automobile ignition systems.

Power Line Filters Many household appliances, such as electric mixers, heating pads, vacuum sweepers, refrigerators, oil burners, sewing machines, doorbells, etc., create an interference of an intermittent nature. The insertion of a line filter near the source of interference often will

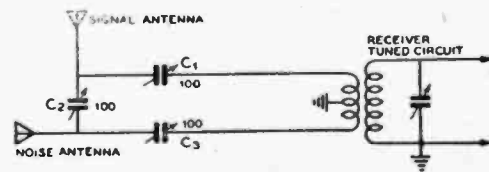

Figure 28.
NOISE-BALANCING CIRCUIT.
This circuit, when properly adjusted, reduces the intensity of power-leak and similar interference.

effect a complete cure. Filters for small appliances can consist of a 0.1- μ fd. capacitor connected across the 110-volt a-c line. Two capacitors in series across the line, with the midpoint connected to ground, can be used in conjunction with ultra-violet ray machines, refrigerators, oil burner furnaces, and other more stubborn offenders. In severe cases of interference, additional filters in the form of heavy-duty r-f choke coils must be connected in series with the 110-volt a-c line on both sides of the line right at the interfering appliance.

Noise Balancing Most power line noise interference can be greatly reduced by the installation of a noise-balancing circuit ahead of the receiver, as shown in Figure 28. The noise-balancing circuit adds the noise components from a separate noise antenna in such a manner that the noise from this antenna will buck the noise picked up by the regular receiving antenna. The noise antenna can consist of a connection through a .002 μ fd. mica capacitor to one side of the a-c line, in some cases, while at other times an additional wire, 20 to 50 feet in length, can be run parallel to the a-c house supply line. The noise antenna should pick up as much noise as possible in comparison with the amount of signal pickup. The regular receiving antenna should be a good-sized outdoor antenna, high and in the clear, so that the signal-to-noise ratio will be as high as possible. When the noise components are balanced out in the circuit ahead of the receiver, the signals will not be attenuated to as great a degree when the signal antenna is very much better than the noise antenna.

This type of noise balancing is not a simple process; it requires a bit of experimentation in order to obtain good results. However, when proper adjustments have been made, it is possible to reduce the power leak noise from 3 to 5 "S" points without reducing the signal strength more than one S point, and in some cases there will be no reduction in signal strength whatsoever. This permits reception of weak signals through bad power leak interference. Hash type interference from electrical appliances can be reduced to a very low value by means of the same circuits.

The coil should be center-tapped and connected to the receiver ground connection in most cases. The pickup coil consists of 4 turns of hookup wire 2 inches in diameter, which can be slipped over the first r-f tuned coil in most radio receivers. A 2-turn coil is more appropriate for 10- and 20-meter operation, though the 4-turn coil is suitable if care is taken in adjusting the three coupling capacitors to avoid 10-meter resonance (unless very loose inductive coupling is used).

When properly balanced, the usual power line buzz can be reduced nearly to zero without attenuating the desired signal more than 50 per cent. Sometimes an incorrect adjustment will result in balancing out the signal as well as the noise. A good high antenna for signal reception will ordinarily overcome this effect.

With this circuit, some readjustment is necessary from band to band in the shortwave spectrum. Noise-balancing systems require a good deal of patience and experimenting at each particular receiving location, but can give satisfying results,

particularly when one band is operated for a considerable period of time.

Peak Noise Limiters Numerous noise-limiting circuits which are beneficial in overcoming key clicks, automobile ignition interference, and similar noise impulses have become popular. They operate on the principle that each individual noise pulse is of very short duration, yet of very high amplitude. The popping or clicking type of noise from electrical ignition systems may produce a signal having a peak value ten to twenty times as great as the incoming radio signal, but an average power much less than the signal.

As the duration of this type of noise peak is short, the receiver can be made inoperative during the noise pulse without the human ear detecting the total loss of signal. Some noise limiters actually *punch a hole* in the signal, while others merely *limit* the maximum peak signal which reaches the headphones or loudspeaker.

The noise peak is of such short duration that it would not be objectionable except for the fact that it produces an overloading effect on the receiver, which increases its time constant. A sharp voltage peak will give a kick to the diaphragm of the headphones or speaker, and the momentum or inertia keeps the diaphragm in motion until the dampening of the diaphragm stops it. This movement produces a popping sound which may completely obliterate the desired signal. If the noise pulse can be limited to a peak amplitude equal to that of the desired signal, the resulting interference is practically negligible for moderately low repetition rates, such as ignition noise.

Virtually all of the practicable peak limiters for radio-telephony employ one or two diodes either as shunt or series limiters in the a-f system. When a noise pulse exceeds a certain predetermined threshold value, the limiter diode acts either as a dead short or open circuit, depending upon whether it is used in a shunt or series circuit. The threshold is made to occur at a level high enough that it will not clip modulation peaks enough to impair voice intelligibility, but low enough to limit the noise peaks effectively.

Because the action of the peak limiter is needed most on very weak signals, and these usually are not strong enough to produce proper a.v.c. action, a threshold setting that is correct for a strong phone signal is not correct for optimum limiting on very weak signals. For this reason the threshold control often is tied in with the a.v.c. system so as to make the optimum threshold adjustment automatic instead of manual.

Suppression of impulse noise by means of an audio peak limiter is best accomplished at the very front end of the audio system, and for this reason the function of superheterodyne second detector and limiter often are combined in a composite circuit.

The amount of limiting that can be obtained is a function of the audio distortion that can be tolerated. Because excessive distortion will reduce the intelligibility as much as will background noise, the degree of limiting for which the circuit is designed has to be a compromise.

Peak noise limiters working at the second detector are much more effective when the i-f bandwidth of the receiver is broad, because a sharp i-f amplifier will produce an integrating effect which lengthens the pulses by the time they reach the second detector, making the limiter less effective. U.h.f. superheterodynes have an i-f bandwidth considerably wider than the minimum necessary for voice sidebands (to take care of drift and instability). Therefore, they are capable of better peak noise suppression than a standard communications receiver having an i-f bandwidth of perhaps 8 kc. Likewise, when a crystal filter is used on the "sharp" position an a-f peak limiter is of little benefit.

Practical Peak Noise Limiter Circuits Noise limiters range all the way from an audio stage running at very low screen or plate voltage, to elaborate affairs employing 5 or more tubes. Rather than attempt to show the numerous types, many of which are quite complex considering the mediocre results obtained, only two very similar types will be described. Either is just about as effective as the most elaborate limiter that can be constructed, yet requires the addition of but a single diode and a few resistors and capacitors over what would be employed in a good superheterodyne without a limiter. Both circuits, with but minor modifications in resistance and capacitance values, are incorporated in one form or another in different types of factory-built communications receivers.

Referring to Figure 29, the first circuit shows a conventional superheterodyne second detector, a.v.c., and first audio stage with the addition of one tube element, D_2 , which may be either a separate diode or part of a twin-diode as illustrated. Diode D_2 acts as a series gate, allowing audio to get to the grid of the a-f tube only so long as the diode is conducting. The diode is biased by a d-c voltage obtained in the same manner as a.v.c. control voltage, the bias being such that pulses of short duration no longer conduct when the pulse voltage exceeds the carrier by approximately 60 per cent. This also clips voice modulation peaks, but not enough to impair intelligibility.

It is apparent that the series diode clips only *positive* modulation peaks, by limiting upward modulation to about 60 per cent. Negative or downward peaks are limited automatically to 100 per cent in the detector, because obviously the rectified voltage out of the diode detector cannot be less than zero. Limiting the downward peaks to 60 per cent or so instead of 100 per cent would result in but little improvement in noise

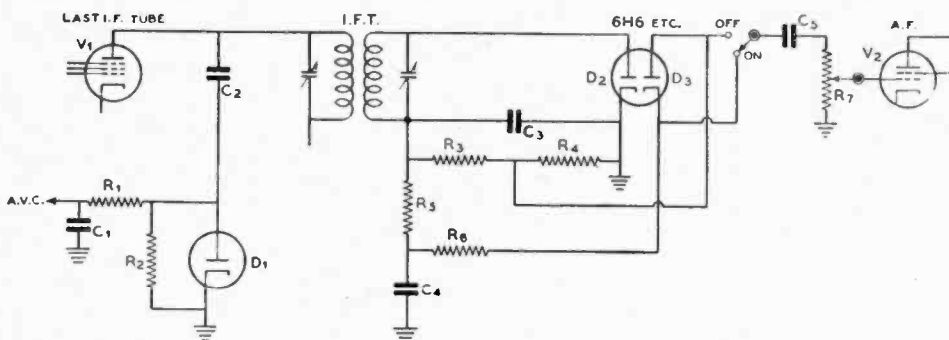

- C_1 —0.1 μ fd., 200 v.
- C_2 —50 μ fd. mica
- C_3 —100 μ fd. mica
- C_4, C_5 —.01 μ fd.
- R_1, R_2 —1 meg., 1/2 watt
- R_3, R_4 —250,000 ohms, 1/2 watt (10% tolerance)
- R_5, R_6 —1 meg., 1/2 watt
- R_7 —2 meg. potentiometer, a.f. taper

Figure 29.

PEAK NOISE LIMITER AND ASSOCIATED CIRCUITS.

This limiter is of the series type, and is self adjusting to the carrier strength for phone reception. For proper operation, at least 5 volts should be developed across the secondary of I.F.T. under carrier conditions.

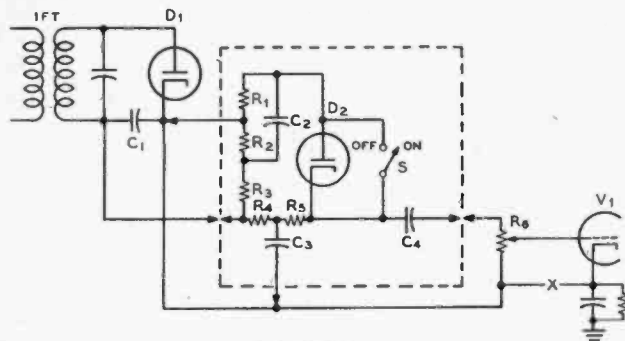

Figure 30.

IMPROVED NOISE-LIMITER CIRCUIT.

This circuit is of the self-adjusting series type and gives less distortion with approximately the same limiting effectiveness as the circuit of Figure 29.

R ₁ —470K, ½ watt	C ₁ —0.00025 mica approx.
R ₂ —100K, ½ watt	C ₂ —0.01-µfd. paper
R ₃ —470K, ½ watt	C ₃ —0.1-µfd. paper
R ₄ , R ₅ —1 meg., ½ watt	C ₄ —0.01-µfd. paper
R _v —1 megohm volume control	D ₁ , D ₂ —6H6, 6AL5, 7A6, etc.

reduction, and the results do not justify the additional components required.

It is important that the exact resistance values shown be used, for best results, and that 10 per cent tolerance resistors be used for R₃ and R₄. Also, the rectified carrier voltage developed across C₄ should be at least 5 volts for good limiting.

The limiter will work well on c-w telegraphy if the amplitude of beat frequency oscillator injection is not too high. Variable injection is to be preferred, adjustable from the front panel. If this feature is not provided, the b.f.o. injection should be reduced to the lowest value that will give a satisfactory beat. When this is done, effective limiting and a good beat can be obtained by proper adjustment of the r-f and a-f gain controls. It is assumed, of course, that the a.v.c. is cut out of the circuit for c-w telegraphy reception.

Alternative Limiter Circuit The circuit of Figure 30 is even more effective than that shown in Figure 29 and requires the addition of only one more resistor and one more capacitor than the other circuit. Also, this circuit involves a loss of only about 2 db in audio output level as contrasted to approximately 6 db in the circuit of Figure 29. This circuit can be used with equal effectiveness with a combined diode-triode or diode-pentode tube (6R7, 6SR7, 6Q7, 6SQ7 or similar diode-triodes, or 6B8, 6SF7, or similar diode-pentodes) as diode detector and first audio stage. However, a separate diode must be used for the noise limiter, D₂. This diode may be one-half of a 6H6, 6AL5, 7A6, etc., or it may be a triode connected 6J5, 6C4 or similar type. Note that the return for the volume control must be made to the cathode of the detector diode (and not to ground) when a dual tube is used as combined second-detector first-audio. This means that in the circuit shown in Figure 30 a connection will exist across the points where the "X" is shown on the diagram since a common cathode lead is brought out of the tube for D₁ and V₁. If desired, of course, a single dual diode may be used for D₁ and D₂ in this circuit as well as in the circuit of Figure 29. Switching the limiter in and out with the switch S brings about no change in volume.

In any diode limiter circuit such as the ones shown in these two figures it is important that the mid-point of the heater potential for the noise-limiter diode be as close to ground potential as possible. This means that the center-tap of the heater supply for the tubes should be grounded wherever possible rather than grounding one side of the heater supply

as is often done. Difficulty with hum pickup in the limiter circuit may be encountered when one side of the heater is grounded due to the high values of resistance necessary in the limiter circuit.

The circuit of Figure 30 has been used with excellent success in several home-constructed receivers, and in the BC-312/BC-342 series of surplus communications receivers. It is also used in certain manufactured receivers.

Incidentally, an excellent check on the operation of the noise limiter in any communications receiver can be obtained by listening to the Loran signals in the old 160-meter band. With the limiter out a sharp rasping buzz will be obtained when one of these stations is tuned in. With the noise limiter switched into the circuit the buzz should be almost entirely eliminated and only a slight low-pitched hum should be heard.

5-9 Special Considerations in V-H-F Receiver Design

Transmission Line Circuits At increasingly higher frequencies, it becomes progressively more difficult to obtain a satisfactory amount of selectivity and impedance from an ordinary coil and capacitor used as a resonant circuit. On the other hand, quarter wavelength sections of parallel conductors or concentric transmission line are not only better but also become of practical dimensions.

Full quarter wavelength lines resonate regardless of the ratio of diameter to conductor spacing—with due allowance for the length of the shorting disc or bar. Substantial open-end impedance, Z_s, and selectivity, Q, can be built up with lines less than a quarter wavelength, loaded with capacitance at the open end, provided that the capacitor is an excellent one—preferably copper plates attached to the conductors with no dielectric losses. This is more important, of course, in lines used for frequency control that are lightly loaded. Lines also can be tuned (if not loaded with capacitance) by substituting a variable capacitor for the shorting bar or disc.

Any unintentional radiation from a coupling link, or resistance coupled into the line, will reduce its effectiveness. Lines that are much shorter than a quarter wave may require considerable capacitance to restore resonance; the amount of required capacitance can be reduced by using a line with a higher surge impedance—that is, wider spacing for 2-wire lines, or a smaller inner conductor for a given outer conductor of a coaxial line. For greatest selectivity, or oscillator frequency control, the conductor radius should be about a quarter of the center-to-center line spacing or, in a coaxial, the inner conductor should be a quarter of the diameter of the outer pipe. For high impedance, ordinarily desired anywhere except for oscillator frequency control, the ratio can be 8-to-1 or higher, thus reducing the necessary loading capacitance on short lines.

Very large spacing is undesirable on open wire lines where the shorting bar may radiate so much that the tuned circuit has radiation resistance coupled into it and the impedance is reduced. Preferably, the active surfaces of lines should be copper or silver. A thin chrome plate over copper is also fairly satisfactory, as is an aluminum surface. The conductivity of the center conductor in a coaxial tank is much more important than that of the outer conductor, due to its smaller diameter.

Tuning Short Lines Tubes hooked on to the open end of a transmission line provide a capacitance that makes the resonant length less than a quarter wavelength. The same holds true for a loading capacitor. How much the line is shortened depends on its surge impedance. It is given by the equation for resonance:

$$\frac{1}{2\pi fC} = Z_0 \tan l$$

in which $\pi = 3.1416$, f is the frequency, C the capacitance, Z_0 the surge impedance of the line, and $\tan l$ is the tangent of the electrical length in degrees.

The surge or characteristic impedance of such lines can be calculated from the equations $Z_0 = 276.4 \log_{10} (D/r)$ ohms for 2-wire lines and $Z_0 = 138.15 \log_{10} (b/a)$ ohms for coaxial lines, where Z_0 is the surge impedance, \log_{10} refers to the common logarithm, D and r refer to center-to-center spacing and conductor radius of two wire lines, b and a are outer conductor inner diameter and inner conductor outer diameter for coaxial lines. Charts showing characteristic surge impedance for parallel conductors and for coaxial lines may be found in Chapter 12.

The capacitive reactance of the capacitance across the end is $1/(2\pi f C)$ ohms. For resonance, this must equal the surge impedance of the line times the tangent of its electrical length (in degrees, where 90° equals a quarter wave). It will be seen that twice the capacitance will resonate a line if its surge impedance is halved; also that a given capacitance has twice the loading effect when the frequency is doubled.

The accompanying chart (Figure 31) can be used to determine the necessary line length of tuning capacitance. For the 2-meter band (147 Mc.) use the 49 Mc. curve but divide the capacitance and line length scales by three. That is, if an 81.04-ohm line 36 inches long will tune to 49 Mc. with 30 μmfd capacitance, an 81.04-ohm line 12 inches long will tune to 147 Mc. with a 10- μmfd capacitor. Likewise, a 60-inch line of the same impedance will tune to 28 Mc. with 56.40 μmfd . This sounds like a lot of capacitor, and can be reduced to 28.20 μmfd . by doubling the line impedance to 162.08 ohms. But, in any event, this circuit will outperform a coil both as to gain and selectivity. The capacitances mentioned include circuit capacitance; in the case of a mixer preceded by an r-f stage, this will amount to about 10 μmfd . with acorn tubes, allowing 3 μmfd . for capacitor minimum.

Coupling Into Lines It is possible to couple into a parallel-rod line by tapping directly on one or both rods, preferably through blocking capacitors if any d.c. is present. More commonly, however, a "hairpin" is inductively coupled at the shorting bar end, either to the bar or to the two rods, or both. This usually results in a balanced load. Should a loop unbalanced to ground be coupled in, any resulting unbalance reflected into the rods can be reduced with a simple Faraday screen, made of a few parallel wires placed between the hairpin loop and the rods. These should be soldered at only one end and grounded.

An unbalanced tap on a coaxial resonant circuit can be made directly on the inner conductor at the point where it is properly matched. For low impedances, such as a concentric line feeder, a small one-half turn loop can be inserted through a hole in the outer conductor of the coaxial circuit, being in effect a half of the hairpin type recommended for coupling balanced feeders to coaxial resonant lines. The size of the loop and closeness to the inner conductor determines the impedance matching and loading. Such loops coupled in near the shorting disc do not alter the tuning appreciably, if not overcoupled. Various coupling circuits are shown in Figure 32.

Resonant Cavities A cavity is a closed resonant chamber made of metal. It is known also as a rhumbatron. The cavity, having both inductance and capacitance, supersedes coil-capacitor and capacitance-loaded transmission-line tuned circuits at extremely high frequencies where common L and C components, of even the most refined design, prove impractical because of the tiny electrical and physical dimensions they must have. Microwave cavities have high Q factors and are superior to conventional tuned circuits. They may be

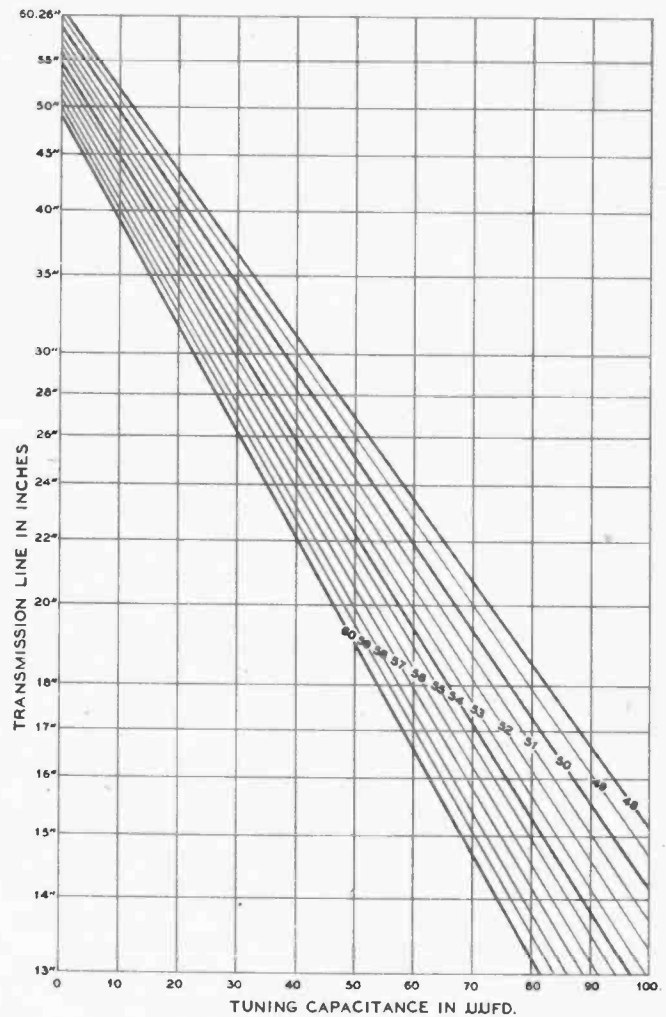

Figure 31.
CHART SHOWING CAPACITANCE REQUIRED TO RESONATE SHORTENED LINES OF 81 OHM SURGE IMPEDANCE.

See text for method of converting to other frequencies and surge impedances. Chart applies directly to coaxial lines and, through conversions discussed in the text, to open-wire lines.

employed in the manner of an absorption wavemeter or as the tuned circuit in other r-f test instruments and in microwave transmitters and receivers.

Resonant cavities usually are closed on all sides and all of their walls are made of electrical conductor. However, in some forms, small openings are present for the purpose of excitation. Cavities have been produced in several shapes including the plain sphere, dimpled sphere, sphere with reentrant cones of various sorts, cylinder, prism (including cube), ellipsoid, ellipsoid-hyperboloid, doughnut-shape, and various reentrant types. In appearance, they resemble in their simpler forms metal boxes or cans.

The cavity actually is a linear circuit, but one which is superior to the transmission line. The cavity resonates in much the same manner as does a barrel or a closed room with reflecting walls into which sound is introduced. It is a common experience to have heard the reinforcement of sound of a critical frequency in a room or barrel.

Because electromagnetic energy, and the associated electrostatic energy, oscillates to and fro inside them in one mode or another, resonant cavities resemble wave guides. The mode of operation in a cavity is affected by the manner in which microwave energy is injected. Harmonics of a fundamental frequency may be present.

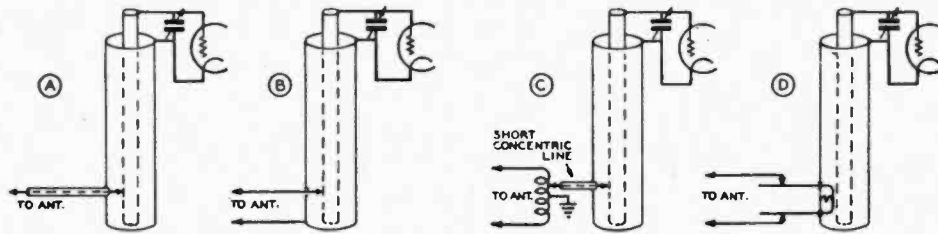

Figure 32.

METHODS OF COUPLING ANTENNA TO COAXIAL RESONANT CIRCUIT.

(A) Coupling a concentric line feeder to a concentric line resonant circuit. (B) Unbalanced method of coupling 2-wire line into a concentric line circuit. (C) Balanced-to-unbalanced method of coupling a 2-wire line to a concentric line resonant circuit. (D) Balanced loop method of obtaining good coupling from 2-wire line to a concentric line circuit.

Figure 33 depicts the evolution of the simple cylindrical cavity. Other shapes may be analyzed in much the same fashion. After such a unit is derived, it remains to inject microwave energy into the cavity to have it resonate at the same frequency as an equivalent L-C tank. Energy may be injected into a cavity by means of a concentric-line probe (Figure 34A); loop (34B); hole (34C); grid-filled holes, as when the cavity is mounted inside an electron tube (34D); or by means of an attached wave guide.

The resonant frequency of a cavity may be varied, if desired, by means of a metal sphere, as shown in Figure 35A, or a movable metal disc (See Figure 35B). When the disc or slug is at the center of the cavity, the resonant frequency is lowest, because the slug shortens the electrostatic (E) lines and increases the effective capacitance. When the slug is at the top or bottom of the cavity, however, the resonant frequency is highest because the slug shortens the magnetic (H) lines and decreases the effective inductance. A cavity that is too small for a given wavelength will not oscillate.

The resonant frequencies of simple spherical, cylindrical, and cubical cavities may be calculated simply for one particular mode. Wavelength (in centimeters) is indicated by the following simple resonance formulae:

- For Cylinder $\lambda_r = 2.6 \times \text{radius}$
- " Cube $\lambda_r = 2.83 \times \text{half of one side}$
- " Sphere $\lambda_r = 2.28 \times \text{radius}$

Butterfly Circuit Unlike the cavity resonator which in its conventional form is a device which can tune over a very narrow band, the butterfly circuit is a tunable resonator which permits coverage of a microwave band. The butterfly circuit is very similar to a conventional coil-variable capacitor combination, except that both inductance and capacitance are provided by what appears to be a variable capacitor alone. The Q of this device is somewhat less than that of a

concentric-line tuned circuit but is entirely adequate for numerous applications.

Figure 36A shows construction of a single butterfly section. The butterfly-shaped rotor, from which the device derives its name, turns in relation to the unconventional stator. The two stator "fins" or sectors are in effect joined together by a semi-circular metal band, integral with the sectors, which provides the circuit inductance. When the rotor is set to fill the loop opening (the position in which it is shown in Figure 36A), the circuit inductance is reduced to minimum. When the rotor occupies the position indicated by the dotted lines, the inductance is maximum. The tuning range of practical butterfly circuits is in the ratio of 1.5:1 to 3.5:1.

Direct circuit connections may be made to points A and B. If balanced operation is desired, either point C or D will provide the "center-tap" (electrical mid-point). Coupling may be effected by means of a small single-turn loop placed near point E or F. The butterfly thus permits continuous variation of both capacitance and inductance, as indicated by the equivalent circuit in Figure 36B, while at the same time eliminating all pigtailed and wiping contacts.

Several butterfly sections may be stacked in parallel in the same way that variable capacitors are built up. In stacking these sections, the effect of adding inductances in parallel is to lower the total circuit inductance, while the addition of stators and rotors raises the total capacitance, as well as the ratio of maximum to minimum capacitance.

Butterfly circuits have been applied specifically, at this time, to oscillators for transmitters, superheterodyne receivers, and heterodyne frequency meters in the 100-1000-Mc. group.

Receiver Circuits The types of resonant circuits described in the previous paragraphs have largely replaced conventional coil-capacitor circuits in the range above 100 Mc. Tuned short lines and butterfly circuits are used in the range from about 100 Mc. to perhaps 3500 Mc., and above

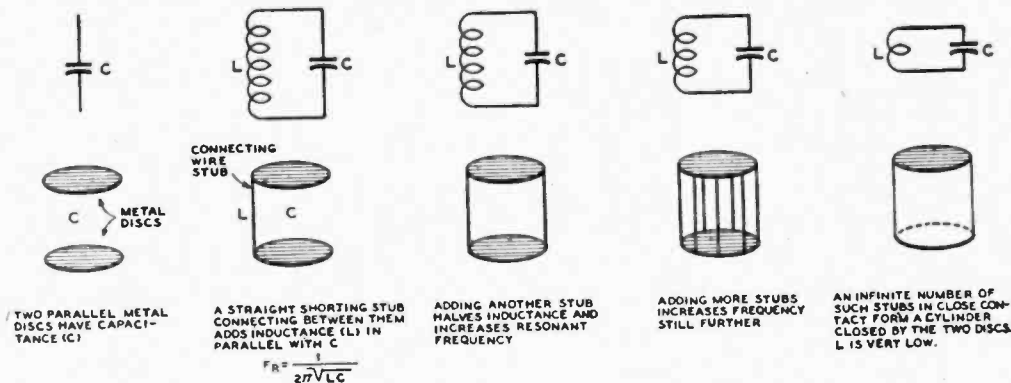

EVOLUTION OF RESONANT CAVITY

Figure 33.

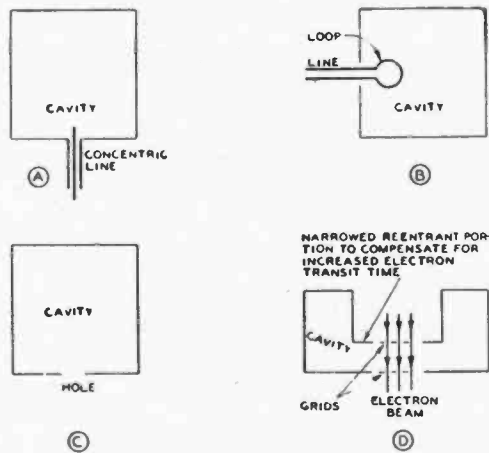

Figure 34.
METHODS OF EXCITING RESONANT CAVITIES.

about 3500 Mc. resonant cavities are used almost exclusively. The resonant cavity is also quite generally employed in the 2000-Mc. to 3500-Mc. range.

Even a perfect circuit must be coupled to something to be useful. A vacuum-tube grid presents an apparent low resistance to the tuned circuit at short wavelengths. At 60 Mc., this is about 2300 and 2500 ohms for the 6L7 and 1852, compared with 54,000 for the acorn 954 and 956 and the newer low-priced button tubes, the 9001 and 9003. Normal receiving pentodes have a relatively low input resistance even at 30 Mc., reducing the effectiveness of the best circuit. With increasing frequency, there is a point for each tube where the output is no larger than the input, and the shot-effect noise is added to the signal arriving in its plate circuit. This makes necessary the use of special v-h-f tubes above a certain frequency.

In a properly designed receiver, thermal agitation in the first tuned circuit is amplified by subsequent tubes and predominates in the output. For good signal-to-set-noise ratio, therefore, one must strive for a high-gain r-f stage exclusive of regeneration. Hiss can be held down by giving careful attention to this point. A mixer has about 0.3 of the gain of an r-f tube of the same type; so it is advisable to precede a mixer by an efficient r-f stage. It is also of some value to have good r-f selectivity before the first detector in order to reduce noises produced by beating noise at one frequency against noise at another, to produce noise at the intermediate frequency in a superheterodyne or at audio frequencies in a super-regenerator.

The frequency limit of a tube is reached when the shortest possible external connections are used as the tuned circuit, except for abnormal types of oscillation. Generally, amplifiers will operate at higher frequencies than will oscillators. For satisfactory efficiency in an amplifier, it is important to place all tuning capacitors so that leads and capacitor frame have very little inductance. Otherwise, such leads should be increased to an electrical half wavelength. Wires or parts are often best considered as sections of transmission lines rather than as simple resistances, capacitances, or inductances.

So long as small triodes and pentodes will operate normally, they are generally preferred as v-h-f tubes over other receiving methods that have been devised. However, the input capacitance of these tubes limits the frequency to which they can be tuned. The input resistance, which drops to a low value at very short wave-lengths, limits the stage gain and broadens the tuning. The effect of these factors can be reduced by tapping the grid down on the input circuit, if a reasonably good tuned circuit is used.

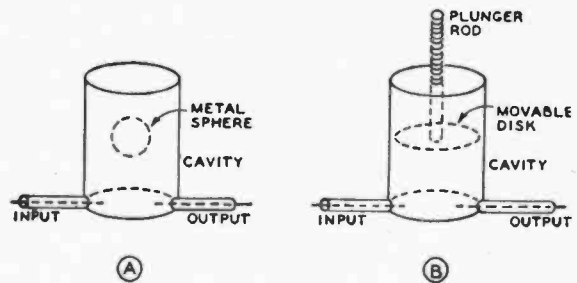

Figure 35.
TUNED RESONANT CAVITIES.

V-H-F Tubes The first tube in a v-h-f receiver is most important in raising the signal above the noise generated in successive stages, for which reason small v-h-f types are definitely preferred. Regeneration increases over-all gain without improving the signal-to-noise ratio, provided that increased selectivity in the regenerative stage does not determine the receiver's over-all selectivity.

Tubes employing the conventional grid-controlled and diode rectifier principles have been modernized, through various expedients, for operation at frequencies as high, in some new types, as 4000 Mc. Beyond that frequency, electron transit time becomes the limiting factor and new principles must be enlisted. In general, the improvements have consisted of (1) reducing electrode spacing to cut down electron transit time, (2) reducing electrode areas to decrease interelectrode capacitances, and (3) shortening of electrode leads either by mounting the electrode assembly close to the tube base or by bringing the leads out directly through the glass envelope at nearby points. Through reduction of lead inductance and interelectrode capacitances, input and output resonant frequencies due to tube construction have been increased substantially.

Tubes embracing one or more of the adaptive features just outlined include the later local types (particularly the 1.4-volt series), high-frequency acorns, button-base types, and the new lighthouse types. Type 6J4 button-base triode will reach 500 Mc. Type 6F4 acorn triode is recommended for use up to 1200 Mc. Type 1A3 button-base diode has a resonant frequency of 1000 Mc., while type 9005 acorn diode resonates at 1500 Mc. Lighthouse type 2C40 can be used at frequencies up to 3500 Mc. as an oscillator.

Crystal Rectifiers More than two decades have passed since the crystal (mineral) rectifier enjoyed widespread use in radio receivers. Low-priced tubes completely supplanted the fragile and relatively insensitive crystal detector, although it did continue for a few years as a simple meter rectifier in absorption wavemeters after its demise as a receiver component.

Today, the crystal detector is of new importance in microwave communication. It is being employed as a detector and as a mixer in receivers and test instruments used at extremely high radio frequencies. At some of the frequencies employed in microwave operations, the crystal rectifier is the only satisfactory detector or mixer. The chief advantages of the crystal rectifier are very low capacitance, freedom from transit-time difficulties, and its two-terminal nature. No batteries or a-c power supply are required for its operation.

The crystal detector consists essentially of a small piece of silicon or germanium mounted in a base of low-melting-point alloy and contacted by means of a thin, springy feeler wire known as the *cat whisker*. This arrangement is shown in Figure 37A.

The complex physics of crystal rectification is beyond the

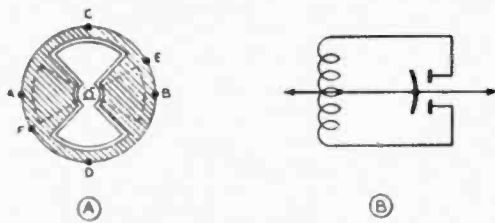

Figure 36.
BUTTERFLY CIRCUIT.

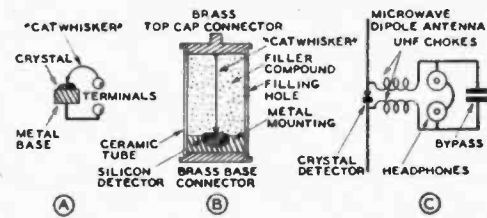

Figure 37.
MICROWAVE CRYSTAL DETECTOR.

scope of this discussion. It is sufficient to state that current flows from several hundred to several thousand times more readily in one direction through the contact of cat whisker and crystal than in the opposite direction. Consequently, an alternating current (including one of microwave frequency) will be rectified by the crystal detector. The load, through which the rectified currents flow, may be connected in series or shunt with the crystal, although the former connection is most generally employed. Certain spots on the crystal surface afford more intense output currents than others and these accordingly are searched for with the cat whisker.

If the cat whisker is by some means permanently secured in contact with a very sensitive spot, a *fixed crystal detector* is obtained which requires no further adjustment. The basic arrangement of a modern fixed crystal detector developed during World War II for microwave work, particularly radar, is shown in Figure 37B. Once the cat whisker of this unit is set at the factory to the most sensitive spot on the surface of the silicon crystal and its pressure is adjusted, a filler compound is injected through the filling hole to hold the cat whisker permanently in position.

Crystal detectors are damaged easily by strong local signals which destroy their sensitive spots. However, when these units follow radio-frequency amplifiers or heterodyne oscillators, the impressed signal may be limited to a safe value by means of careful circuit design and adjustment. Crystal mixers used in radar receivers are protected by a gaseous diode connected across the resonant cavity which breaks down whenever the transmitter is triggered.

Figure 37C shows the simplest microwave receiver employing a crystal detector. If the headphones are replaced with a d-c microammeter, the arrangement may be used as a simple field strength meter.

Superregenerative Receivers A very effective simple receiver for use at ultra-high frequencies, if properly adjusted, is the superregenerative receiver.

The theory of this type is covered in Section 5-2 of this chapter and is illustrated in Chapter 20.

Superheterodyne Receivers Although they involve the use of more tubes, superheterodyne receivers are somewhat less critical to adjust properly than the superregenerative type. Superheterodyne receivers are described in detail in Section 5-3 of this chapter. They have the advantage of not causing broad interference locally, and have greater selectivity. The main problem in them is to obtain adequate oscillator voltage injection so that the conversion gain is satisfactory. Screen or suppressor injection requires a strong oscillator if the mixer tube's grid circuit is properly shielded; if it is not, leakage to the control grid will provide grid injection. The latter (often recommended by tube manufacturers for best gain on ultra-high frequencies) results in greatest "pulling" but this can be eliminated by use of a high intermediate frequency and proper construction.

Cathode injection is not recommended by manufacturers because a long cathode lead increases the *transit time effect* and

decreases the apparent input resistance of the tube; however, at very high frequencies, several good receivers have used this variation of grid injection by having the mixer cathode clip tap directly on the oscillator tank with very little inductance from the tap to ground and to the grid and plate r-f return leads.

A stable hum-free oscillator is necessary in a u-h-f superheterodyne. Small tubes like the 955, 6C4, and 9002 are satisfactory for this purpose. Heater chokes may reduce hum in cathode-above-ground circuits. Oscillator-doubler circuits or a very high i.f. can be used to reduce the oscillator frequency. Crystal controlled oscillator can be used when the i-f channel is a tunable receiver.

Here again, an r-f stage is advantageous to prevent the oscillator from radiating, and to obtain the best signal-to-set-noise ratio. Since the gain of the r-f stage will ordinarily be higher than that of the mixer, its output will override subsequent noise in the receiver. The use of sections of transmission lines instead of coils can improve gain and simplify adjustment and ganging.

High signal input resulting from the use of a carefully designed antenna and feed line, and properly adjusted coupling to the input circuit of the receiver, are essential in obtaining maximum performance. Balanced or shielded feed lines, to reduce pick-up of undesired outside noise, are helpful. The best antenna systems are generally those that are most effective at angles close to the horizontal.

5-10 Receiver Adjustment

A simple regenerative receiver requires little adjustment other than those necessary to insure correct tuning and smooth regeneration over some desired range. Receivers of the tuned radio-frequency type and superheterodynes require precise alignment to obtain the highest possible degree of selectivity and sensitivity.

Good results can be obtained from a receiver only when it is properly aligned and adjusted. The most practical technique for making these adjustments is given below.

Instruments A very small number of instruments will suffice to check and align any multitube receiver, the most important of these testing units being a modulated oscillator and a d-c and a-c voltmeter. The meters are essential in checking the voltage applied at *each* circuit point from the power supply. If the a-c voltmeter is of the oxide-rectifier type, it can be used, in addition, as an output meter when connected across the receiver output when tuning to a modulated signal. If the signal is a steady tone, such as from a test oscillator, the output meter will indicate the value of the detected signal. In this manner, lineup adjustments may be visually noted on the meter rather than by increases or decreases of sound intensity as detected by ear.

T.R.F. Receiver Alignment Alignment procedure in a multistage t.r.f. receiver is exactly the same as aligning a single stage. If the detector is regenerative, each preceding stage is successively aligned while keeping the detector circuit tuned to the test signal, the latter being a sta-

tion signal or one locally generated by a test oscillator loosely coupled to the antenna lead. During these adjustments, the r.f. amplifier gain control is adjusted for maximum sensitivity, assuming that the r.f. amplifier is stable and does not oscillate. Oscillation is indicative of improper by-passing or shielding. Often a sensitive receiver can be roughly aligned by tuning for maximum noise pickup.

Superheterodyne Alignment

Aligning a superhet is a detailed task requiring a great amount of care and patience. It should never be undertaken without a thorough understanding of the involved job to be done and then only when there is abundant time to devote to the operation. There are no short cuts; every circuit must be adjusted individually and accurately if the receiver is to give peak performance. The precision of each adjustment is dependent upon the accuracy with which the preceding one was made.

Superhet alignment requires (1) a good signal generator (modulated oscillator) covering the radio and intermediate frequencies and equipped with an attenuator and B-plus switch; (2) the necessary socket wrenches, screwdrivers, or "neutralizing tools" to adjust the various i-f and r-f trimmer capacitors; and (3) some convenient type of tuning indicator, such as a copper-oxide or electronic voltmeter.

Throughout the alignment process, unless specifically stated otherwise, the r-f gain control must be set for maximum output, the beat oscillator switched off, and the a.v.c. turned off or shorted out. When the signal output of the receiver is excessive, either the attenuator or the a-f gain control may be turned down, but never the r-f gain control.

I-F Alignment After the receiver has been given a rigid electrical and mechanical inspection, and any faults which may have been found in wiring or the selection and assembly of parts corrected, the i-f amplifier may be aligned as the first step in the checking operations.

The coils for the r-f (if any), mixer, and high-frequency oscillator stages must be in place. It is immaterial which coils are inserted.

With the signal generator set to give a modulated signal on the frequency at which the i-f amplifier is to operate, clip the "hot" output lead from the generator to the last i-f stage through a small fixed capacitor to the control grid. Adjust both trimmer capacitors in the last i-f transformer (the one between the last i-f amplifier and the second detector) to resonance as indicated by maximum deflection of the output meter.

Each i-f stage is adjusted in the same manner, moving the hot lead, stage by stage, back toward the front end of the receiver and backing off the attenuator as the signal strength increases in each new position. The last adjustment will be made to the first i-f transformer, with the hot signal generator lead connected to the control grid of the mixer. Occasionally it is necessary to disconnect the mixer grid lead from the coil, coupling it through a 1,000- or 5,000-ohm resistor, and coupling the signal generator through a small capacitor to the grid.

When the last i-f adjustment has been completed, it is good practice to go back through the i-f channel, re-peaking all of the transformers. It is imperative that this recheck be made in sets which do not include a crystal filter, and where the simple alignment of the i-f amplifier to the generator is final.

I.F. with Crystal Filter There are several ways of aligning an i-f channel which contains a crystal-filter circuit.

However, the following method is one which has been found to give satisfactory results in every case: If the i-f channel is known to be far out of alignment, or if the ini-

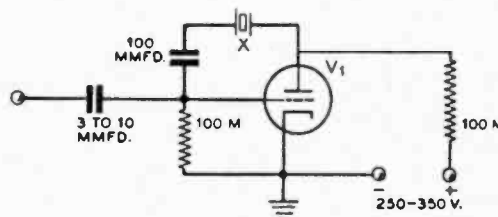

Figure 38.

CRYSTAL TEST OSCILLATOR.

A filter crystal may be placed in an oscillator such as this to make preliminary alignment adjustments. Final touching up should be done with the filter crystal in the receiver and operable.

tial alignment of a new receiver is being attempted, the crystal itself should first be used to control the frequency of a test oscillator. The circuit shown in Figure 38 can be used. The crystal will oscillate at its anti-resonant frequency in this circuit, while as a filter it functions at its resonant frequency. However, the two are sufficiently close together for preliminary adjustments.

Any high transconductance triode such as a 6J5, or a triode connected, high transconductance pentode or beam tube such as a 6SG7 or 6V6 may be used for V_1 . The a-c plate voltage, which is used to give the necessary modulated note, may be obtained by hooking to one plate of the rectifier tube in the receiver power pack.

For the final alignment of a new receiver, or touching up of a receiver that has already been aligned and is suspected of having drifted slightly out, the crystal should be placed in the receiver and an unmodulated carrier from a signal generator fed into the grid of the mixer at the i.f. With the b.f.o. off and the crystal filter switched in, the signal generator is tuned slowly to find where the crystal peaks. The "S" meter of the receiver or a microammeter in series with the second detector load resistor can be used as an indicator. When the crystal peak is found, all i-f transformers are touched up to peak at that frequency.

If a signal generator is not available for this procedure, the coupling from the receiver b.f.o. may be temporarily broken and the output of the b.f.o. coupled loosely to the mixer. In this manner the b.f.o. is made to serve as a signal generator.

B.F.O. Adjustment Adjusting the beat oscillator on a receiver that has no front panel adjustment is relatively simple. It is only necessary to tune the receiver to resonance with any signal, as indicated by the tuning indicator, and then turn on the b.f.o. and set its trimmer (or trimmers) to produce the desired beat note. Setting the beat oscillator in this way will result in the beat note being stronger on one "side" of the signal than on the other, which is what is desired for c-w reception. The b.f.o. should *not* be set to "zero beat" when the receiver is tuned to resonance with the signal, as this will cause an equally strong beat to be obtained on both sides of resonance.

Front-End Alignment Alignment of the front end of a home-constructed receiver is a relatively simple process, consisting of first getting the oscillator to cover the desired frequency range and then of peaking the various r-f circuits for maximum gain. However, if the frequency range covered by the receiver is very wide a fair amount of cut and try will be required to obtain satisfactory tracking between the r-f circuits and the oscillator. Manufactured communications receivers should always be tuned in accordance with the instructions given in the maintenance manual for the receiver.

Generation of Radio-Frequency Energy

A RADIO communication or broadcast transmitter consists of a source of radio frequency power, or *carrier*; a system for *modulating* the carrier whereby voice or telegraph keying or other modulation is superimposed upon it; and an antenna system, including feed line, for *radiating* the intelligence-carrying radio frequency power. The power supply employed to convert primary power to the various voltages required by the r-f and modulator portions of the transmitter may also be considered part of the transmitter. Power supplies are treated separately in Chapter 25.

Voice modulation usually is accomplished by varying either the amplitude or the frequency of the radio frequency carrier in accordance with the components of intelligence to be transmitted. The process of amplitude modulation is covered in detail in Chapter 7 and frequency modulation is covered in Chapter 8.

Radiotelegraph modulation (keying) normally is accomplished either by interrupting, shifting the frequency of, or superimposing an audio tone on the radio frequency carrier in accordance with the dots and dashes to be transmitted.

The complexity of the radio-frequency generating portion of the transmitter is dependent upon the power, order of stability, and frequency desired. An oscillator feeding an antenna directly is the simplest form of radio-frequency generator. A modern high-frequency transmitter, on the other hand, is a very complex generator. Such an equipment usually comprises a very stable crystal-controlled or self-controlled oscillator to stabilize the output frequency, a series of frequency multipliers, and one or more amplifier stages to increase the power up to the level which is desired for feeding the antenna system.

6-1 Self-Controlled Oscillators

In Chapter 4, it was explained that the amplifying properties of a tube having three or more elements give it the ability to generate an alternating current of a frequency determined by the components associated with it. A vacuum tube operated

in such a circuit is called an oscillator, and its function is essentially to convert a source of direct current into radio frequency alternating current of a predetermined frequency.

Oscillators for controlling the frequency of conventional radio transmitters can be divided into two general classes: self-controlled and crystal-controlled.

There are a great many types of self-controlled oscillators, each of which is best suited to a particular application. They can further be subdivided into the classifications of: negative-grid oscillators, electron-orbit oscillators, negative-resistance oscillators, velocity modulation oscillators, and magnetron oscillators.

Negative-Grid Oscillators A negative-grid oscillator is essentially a vacuum-tube amplifier with a sufficient portion of the output energy coupled back into

the input circuit to sustain oscillation. The control grid is biased a considerable amount negative with respect to the cathode. This oscillator finds most common application in low- and medium-frequency transmitter control circuits. Common types of negative-grid oscillators are diagrammed in Figure 1.

The Hartley Illustrated in Figure 1(A) is the oscillator circuit which finds the most general application at the present time; this circuit is commonly called the Hartley. The operation of this oscillator will be described as an index to the operation of all negative-grid oscillators; the only real difference between the various circuits is the manner in which energy for excitation is coupled from the plate to the grid circuit.

When plate voltage is applied to the Hartley oscillator shown at (A), the sudden flow of plate current accompanying the application of plate voltage will cause an electro-magnetic field to be set up in the vicinity of the coil. The building-up of this field will cause a potential drop to appear from turn-to-

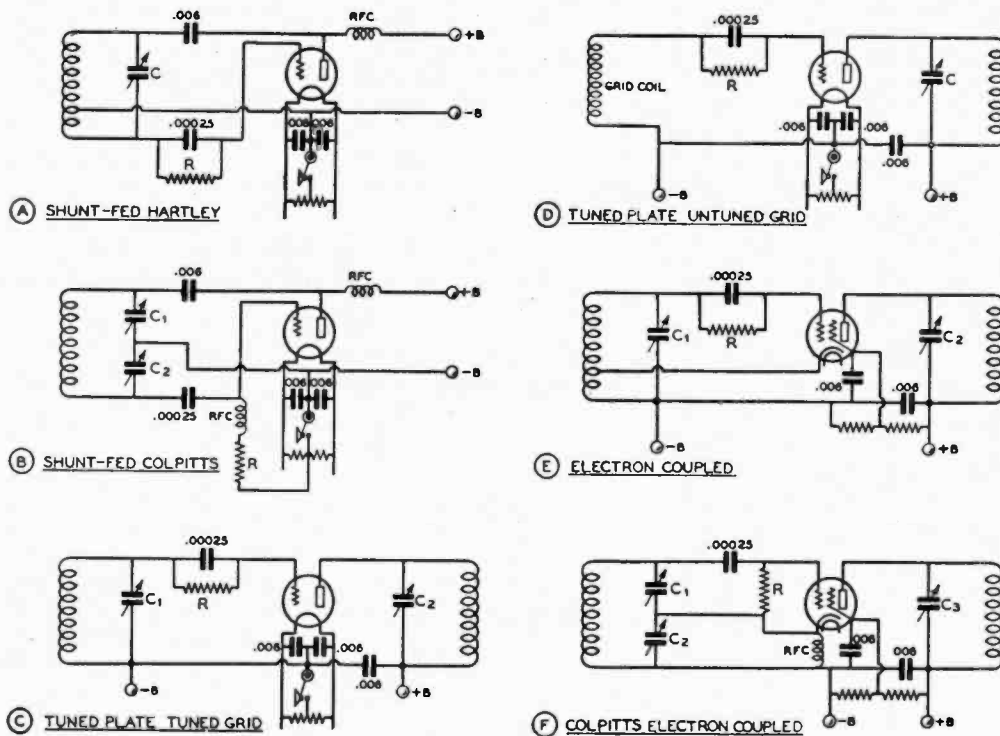

Figure 1.

COMMON TYPES OF SELF-EXCITED OSCILLATORS.

Fixed capacitor values shown are typical, but do not necessarily represent optimum values for every application. Though triodes are shown in A, B, C and D, screen grid tubes may be used, the screen being grounded to r.f. by means of a bypass capacitor.

turn along the coil. Due to the inductive coupling between the portion of the coil in which the plate current is flowing and the grid portion, a potential will be induced in the grid portion.

Since the cathode tap is between the grid and plate ends of the coil, the induced grid voltage acts in such manner as to increase further the plate current to the tube. This action will continue for a short period of time determined by the inductance and capacitance of the tuned circuit, until the "flywheel" effect of the tuned circuit causes this action to come to a maximum and then to reverse itself. The plate current then decreases, the magnetic field around the coil also decreasing, until a minimum is reached, when the action starts again in the original direction and at a greater amplitude than before. The amplitude of these oscillations, the frequency of which is determined by the coil capacitor circuit, will increase in a very short period of time to a limit determined by the plate voltage or the cathode emission of the oscillator tube.

The Colpitts Figure 1 (B) shows a version of the Colpitts oscillator. It can be seen that this is essentially the same circuit as the Hartley except that the ratio of a pair of capacitances in series determines the effective cathode tap, instead of actually using a tap on the tank coil. Also, the net capacitance of these two capacitors comprises the tank capacitance of the tuned circuit. This oscillator circuit is somewhat less susceptible to parasitic (spurious) oscillations than the Hartley.

For best operation of the Hartley and Colpitts oscillators, the voltage from grid to cathode, determined by the tap on the coil or the setting of the two capacitors, normally should be from 1/3 to 1/2 that appearing between plate and cathode. A broadly resonant coil may be substituted for the grid tank to form the T.N.T. oscillator shown at (D).

The T.P.T.G. The tuned-plate tuned-grid oscillator illustrated at (C) has a tank circuit in both the plate and grid circuits. The feedback of energy from the plate

to the grid circuits is accomplished by the plate-to-grid inter-electrode capacitance within the tube. The necessary phase reversal in feedback voltage is provided by tuning the grid tank capacitor to the low side of the desired frequency and the plate capacitor to the high side.

Electron-Coupled Oscillators In any of the oscillator circuits just described it is possible to take energy from the oscillator circuit by coupling an external load to the tank circuit. Since the tank circuit determines the frequency of oscillation of the tube, any variations in the conditions of the external circuit will be coupled back into the frequency determining portion of the oscillator. These variations will result in frequency instability.

The frequency determining portion of an oscillator may be coupled to the load circuit only by an electron stream, as illustrated in (E) and (F) of Figure 1. When it is considered that the screen of the tube acts as the plate to the oscillator circuit, the plate merely acting as a coupler to the load, then the similarity between the cathode-grid-screen circuit of these oscillators and the cathode-grid-plate circuits of the corresponding prototype can be seen.

The electron-coupled oscillator has great stability with respect to load and voltage variation. Load variations have very little effect on the frequency, since the only coupling between the oscillating circuit and the load is through the electron stream flowing through the other elements to the plate. The plate is electrostatically shielded from the oscillating portion by the bypassed screen.

The stability of the e.c.o. with respect to variations in supply voltages is explained as follows: The frequency will shift in one direction with an increase in screen voltage, while an increase in plate voltage will cause it to shift in the other direction. By a proper proportioning of the resistors that comprise the voltage divider supplying screen voltage, it is possible to make the frequency of the oscillator substantially independent of supply voltage variations.

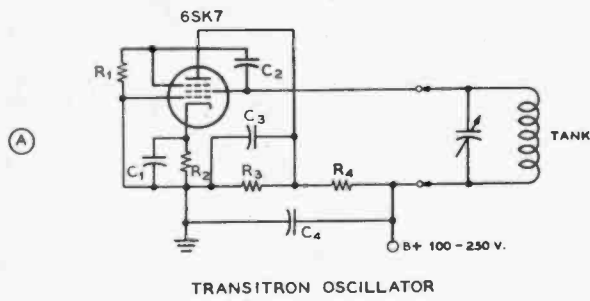

TRANSATRON OSCILLATOR

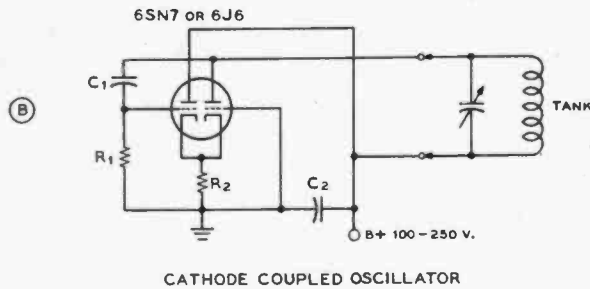

CATHODE COUPLED OSCILLATOR

Figure 2.

TWO-TERMINAL OSCILLATOR CIRCUITS.

Both circuits may be used for an audio oscillator or for frequencies into the v-h-f range simply by placing a tank circuit tuned to the proper frequency where indicated on the drawing. Recommended values for the components are given below for both oscillators.

TRANSATRON OSCILLATOR

- C₁—0.01- μ fd. mica for r.f.
10- μ fd. elect. for a.f.
- C₂—0.00005- μ fd. mica for r.f.
0.1- μ fd. paper for a.f.
- C₃—0.003- μ fd. mica for r.f.
0.5- μ fd. paper for a.f.
- C₄—0.01- μ fd. mica for r.f.
8- μ fd. elect. for a.f.
- R₁—220K $\frac{1}{2}$ -watt carbon
- R₂—1800 ohms $\frac{1}{2}$ -watt carbon

- R₃—22K 2-watt carbon
- R₄—22K 2-watt carbon

CATHODE-COUPLED OSCILLATOR

- C₁—0.00005- μ fd. mica for r.f.
0.1- μ fd. paper for audio
- C₂—0.003- μ fd. mica for r.f.
8- μ fd. elect. for audio
- R₁—47K $\frac{1}{2}$ -watt carbon
- R₂—1K 1-watt carbon

V.F.O. Transmitter controls

When used to control the frequency of a transmitter in which there are stringent limitations on frequency tolerance, several precautions are taken to ensure that a variable frequency oscillator will stay on frequency. The oscillator is fed from a voltage regulated power supply, uses a high-C tank circuit, is of rugged mechanical construction to avoid the effects of shock and vibration, is compensated for or protected against changes in ambient room temperature, and is isolated from feedback or stray coupling from other portions of the transmitter by shielding, filtering of voltage supply leads, and incorporation of one or more "buffer" amplifier stages. In a high power transmitter a small amount of stray coupling from the final amplifier to the oscillator can produce appreciable degradation of the oscillator stability if both are on the same frequency. Therefore, the oscillator usually is operated on a subharmonic of the transmitter output frequency, with one or more frequency multipliers between the oscillator and final amplifier.

Special U-H-F Oscillators Electron-orbit and velocity modulation oscillators are used for extremely high-frequency work (above 700 Mc.) and depend for their operation upon the fact that an electron takes a finite time to pass from one element to another inside a vacuum tube. The *Klystron* and *Magnetron*, two widely used u-h-f and microwave oscillators in the transit time and velocity modulation categories, are described in Chapter 3.

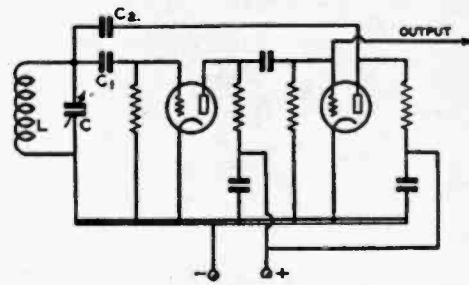

Figure 3.

THE FRANKLIN OSCILLATOR CIRCUIT.

In this oscillator, a separate phase-inverter tube is used to feed a portion of the output back into the input circuit in the proper phase to sustain oscillation.

Negative Resistance Oscillators

Negative-resistance oscillators often are used when unusually high frequency stability is desired, as in a frequency meter.

The *dynatron* of a few years ago and the newer *transitron* are examples of oscillator circuits which make use of the negative resistance characteristic between different elements in some multi-grid tubes.

In the *dynatron*, the negative resistance is a consequence of secondary emission of electrons from the plate of a tetrode tube. By a proper proportioning of the electrode voltage, an increase in screen voltage will cause a decrease in screen current, since the increased screen voltage will cause the screen to attract a larger number of the secondary electrons emitted by the plate. Since the net screen current flowing from the screen supply will be decreased by an increase in screen voltage, it is said that the screen circuit presents a negative resistance.

If any type of tuned circuit, or even a resistance-capacitance circuit, is connected in series with the screen, the arrangement will oscillate—provided, of course, that the external circuit impedance is greater than the negative resistance. A negative resistance effect similar to the *dynatron* is obtained in the *transitron* circuit, which uses a pentode with the suppressor coupled to the screen. The negative resistance in this case is obtained from a combination of secondary emission and inter-electrode coupling, and is considerably more stable than that obtained from uncontrolled secondary emission alone in the *dynatron*. A representative transition oscillator circuit is shown in Figure 2.

The chief distinction between a conventional "negative grid" oscillator and a "negative resistance" oscillator is that in the former the tank circuit must act as a phase inverter in order to permit the amplification of the tube to act as a negative resistance, while in the latter the tube acts as its own phase inverter. Thus a negative resistance oscillator requires only an untapped coil and a single capacitor as the frequency determining tank circuit, and is classed as a "two terminal" oscillator. In fact, the time constant of an R/C circuit may be used as the frequency determining element and such an oscillator is rather widely used as a tunable audio frequency oscillator.

The Franklin Oscillator

The Franklin oscillator makes use of two cascaded tubes to obtain the negative-resistance effect (Figure 3). The tubes may be either a pair of triodes, tetrodes, or pentodes, a dual triode, or a combination of a triode and a multi-grid tube. The chief advantages of this oscillator circuit is that the frequency determining tank only has two terminals, and one side of the circuit is grounded.

The second tube acts as a phase inverter to give an effect similar to that obtained with the *dynatron* or *transitron*, except that the effective transconductance is much higher. If the tuned

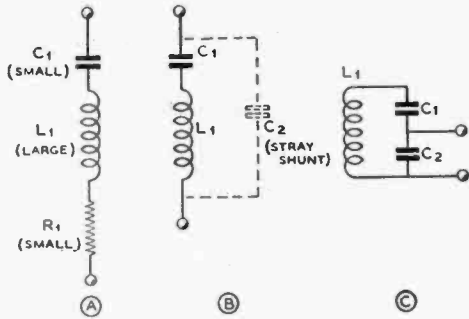

Figure 4.

EQUIVALENT ELECTRICAL CIRCUIT OF QUARTZ PLATE IN A HOLDER

At (A) is shown the equivalent series-resonant circuit of the crystal itself, at (B) is shown how the shunt capacitance of the holder electrodes and associated wiring affects the circuit to the combination circuit of (C) which exhibits both series resonance and parallel resonance (anti-resonance), the separation in frequency between the two modes being very small and determined by the ratio of C_1 to C_2 .

circuit is replaced by an R/C circuit, the oscillator then becomes a *multivibrator*.

6-2 Quartz Crystal Oscillators

Quartz and tourmaline are naturally occurring crystals having a structure such that when plates are cut in certain definite relationships to the crystallographic axes, these plates will show the *piezo-electric* effect—the plates will be deformed in the influence of an electric field, and, conversely, when such a plate is compressed or deformed in any way a potential difference will appear upon its opposite sides.

The crystal has mechanical resonance, and will vibrate at a very high frequency because of its stiffness, the natural period of vibration depending upon the dimensions and crystallographic orientation. Because of the piezo-electric properties, it is possible to cut a quartz plate which, when provided with suitable electrodes, will have the characteristics of a series resonant circuit with a very high L/C ratio and very high Q. The Q is several times as high as can be obtained with an inductor-capacitor combination in conventional physical sizes. The equivalent electrical circuit is shown in Figure 4A, the resistance component simply being an acknowledgment of the fact that the Q, while high, does not have an infinite value.

The shunt capacitance of the electrodes and associated wiring (crystal holder and socket, plus circuit wiring) is represented by the dotted portion of Figure 4B. In a high frequency crystal this will be considerably greater than the capacitance component of an equivalent series L/C circuit, and unless the shunt capacitance is balanced out in a bridge circuit, the crystal will exhibit both resonant (series resonant) and anti-resonant (parallel resonant) frequencies, the latter being slightly higher than the series resonant frequency and approaching it as C_2 is increased.

The parallel resonant characteristic permits the crystal to be used in place of an L/C tank in an oscillator, with greatly increased stability as a result of the much higher Q.

The series resonance characteristic is employed in crystal filter circuits in receivers, as covered in Chapter 5, and also in certain oscillator circuits wherein the crystal is used as a selective feedback element in such a manner that the phase of the feedback is correct and the amplitude adequate only at or very close to the series resonant frequency of the crystal.

While quartz, tourmaline, and Rochelle salts crystals all exhibit the piezo-electric effect, quartz is the material widely employed for frequency control, as their characteristics make tourmaline less desirable and Rochelle salts unsuitable.

As the cutting and grinding of quartz plates has progressed to a high state of development and these plates may be pur-

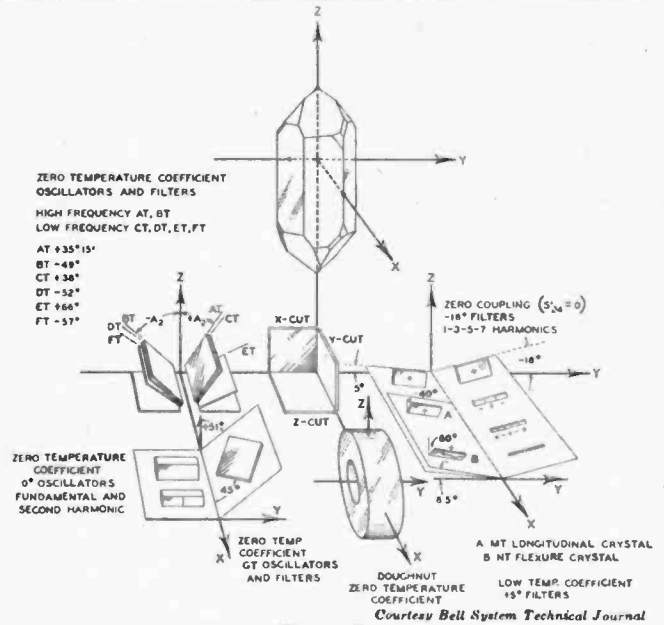

Figure 5.

Illustrating the orientation of the common crystal cuts with respect to the quartz crystal itself.

chased at prices which discourage the cutting and grinding by simple hand methods for one's own use, the procedure will be only lightly touched upon here.

The crystal "blank" is cut from the raw quartz at a predetermined orientation with respect to the optical and electrical axes, the orientation determining the activity, temperature coefficient, thickness coefficient, and other characteristics. Various orientations or "cuts" having useful characteristics are illustrated in Figure 5.

The crystal blank is then rough-ground down almost to exact frequency, the frequency increasing in inverse ratio to the oscillating dimension (usually the thickness). It is then finished to a frequency slightly higher than that desired and then silver plating the electrodes right on the crystal, the frequency decreasing as the deposit of silver is increased. If the crystal is not etched, it must be carefully scrubbed and "baked" several times to stabilize it, or otherwise the frequency and activity of the crystal will change with time. Irradiation by X-rays recently has been used in crystal finishing.

Unplated crystals usually are mounted in "pressure" or "clamped" holders, in which two electrodes are held against the crystal faces under slight pressure. Unplated crystals also are sometimes mounted in an "air gap" holder, in which there is a very small gap between the crystal and one or both electrodes. By making this gap variable, the frequency of the crystal may be altered over narrow limits (about 0.3% for certain types).

The temperature coefficient of frequency for various crystal cuts of the "T" rotated family is indicated in Figure 5. These angles are typical, but crystals of a certain cut will vary slightly. By controlling the orientation and dimensioning, the "turning point" (point of zero temperature coefficient) for a BT cut plate may be made either lower or higher than the 75 degrees shown. Also, by careful control of axes and dimensions, it is possible to get AT cut crystals with a very flat temperature-frequency characteristic.

The first quartz plates used were either Y cut or X cut. The former had a very high temperature coefficient which was discontinuous, causing the frequency to jump at certain critical temperatures. The X cut had a moderately bad coefficient, but

it was more continuous, and by keeping the crystal in a temperature controlled oven, a high order of stability could be obtained. However, the X cut crystal was considerably less active than the Y cut, especially in the case of poorly ground plates.

For frequencies between 500 kc. and about 6 Mc., the AT cut crystal now is the most widely used. It is active, can be made free from spurious responses, and has an excellent temperature characteristic. However, above about 6 Mc. it becomes quite thin, and a difficult production job. Between 6 Mc. and about 12 Mc., the BT cut plate is widely used. It also works well between 500 kc. and 6 Mc., but the AT cut is more desirable when a high order of stability is desired and no crystal oven is employed.

For low frequency operation on the order of 100 kc., such as is required in a frequency standard, the GT cut crystal is recommended, though CT and DT cuts also are widely used for applications between 50 and 500 kc. The CT, DT, and GT cut plates are known as *contour* cuts, as these plates oscillate along the long dimension of the plate or "bar", and are much smaller physically than would be the case for a regular AT or BT cut crystal for the same frequency.

Crystal Holders Crystals normally are purchased ready mounted. The best type mount is determined by the type crystal and its application, and usually an optimum mounting is furnished with the crystal. However, certain features are desirable in all holders. One of these is exclusion of moisture and prevention of electrode oxidization. The best means of accomplishing this is a metal holder, hermetically sealed, with glass insulation and a metal-to-glass bond. However, such holders are more expensive, and a ceramic or phenolic holder with rubber gasket will serve where requirements are not too exacting.

Temperature Control; Crystal Ovens Where the frequency tolerance requirements are not too stringent and the ambient temperature does not include extremes, an AT-cut plate, or a BT-cut plate with optimum (mean temperature) turning point, will often provide adequate stability without resorting to a temperature controlled oven. However, for broadcast stations and other applications where very close tolerances must be maintained, a thermostati-

cally controlled oven, adjusted for a temperature slightly higher than the highest ambient likely to be encountered, must of necessity be employed.

Harmonic Cut Crystals Just as a vibrating string can be made to vibrate on its harmonics, a quartz crystal will exhibit mechanical resonance (and therefore electrical resonance) at harmonics of its fundamental frequency. When employed in the usual holder, it is possible to excite the crystal only on its odd harmonics.

By grinding the crystal especially for harmonic operation, it is possible to enhance its operation as a harmonic resonator, and BT and AT cut crystals designed for optimum operation on the 3d, 5th, and even the 7th harmonic are available. The 5th and 7th harmonic types, especially the latter, require special holder and oscillator circuit precautions for satisfactory operation, but the 3d harmonic type needs little more consideration than a regular fundamental type. A crystal ground for optimum operation on a particular harmonic may or may not be a good oscillator on a different harmonic or on the fundamental. One interesting characteristic of a harmonic cut crystal is that its harmonic frequency is not quite an exact multiple of its fundamental, though the disparity is very small.

The harmonic frequency for which the crystal was designed is the "working frequency". It is not the "fundamental", but the crystal itself actually oscillates on this "working frequency" when it is functioning in the proper manner.

When a harmonic-cut crystal is employed, a selective tuned circuit must be employed somewhere in the oscillator in order to discriminate against the fundamental frequency or undesired harmonics. Otherwise the crystal might not always oscillate on the intended frequency. For this reason the Pierce oscillator, later described in this chapter, is not suitable for use with harmonic-cut crystals, because the only tuned element in this oscillator circuit is the crystal itself.

Crystal Current; Heating and Fracture For a given crystal operating as an anti-resonant tank in a given oscillator at fixed load impedance and plate and screen voltages, the r-f current through the crystal will increase as the shunt capacitance C_2 of Figure 4 is increased, because this effectively increases the "step up ratio" of C_1 to C_2 . For a given shunt capacitance, C_2 , the crystal cur-

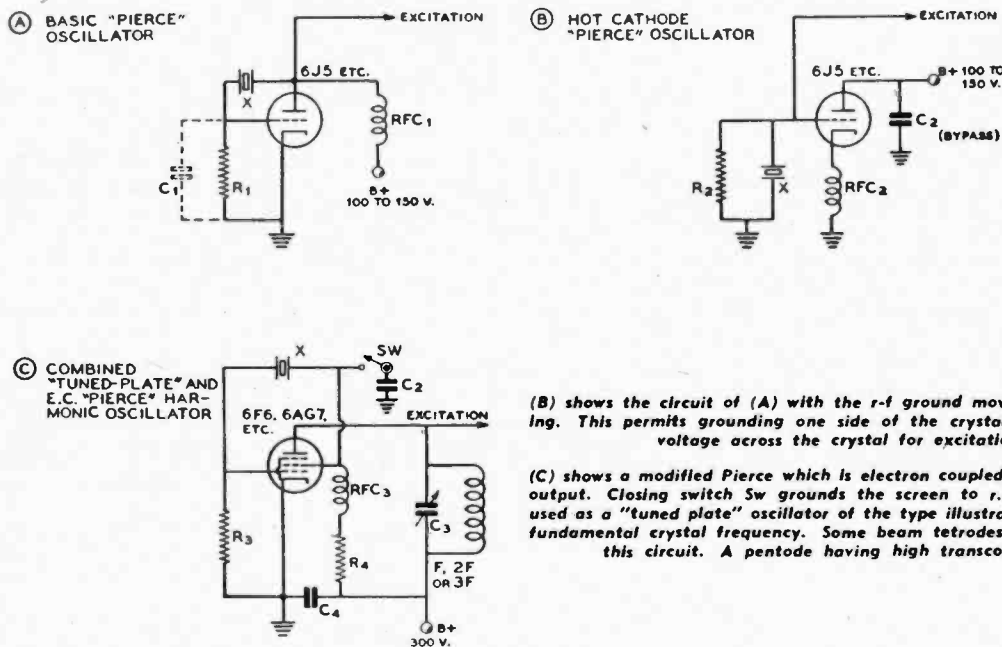

Figure 6. BASIC PIERCE OSCILLATOR CIRCUIT AND VARIATIONS.

(A) shows the basic Pierce oscillator circuit. Unless the shunt capacitance contributed by the following stage is low, C_1 usually will be required for optimum operation. Its value normally is from 25 to 75 μfd . The choke RFC_1 may be replaced by a non-inductive resistor of 50,000 ohms. A higher plate supply voltage then will be required.

(B) shows the circuit of (A) with the r-f ground moved to the plate, the cathode floating. This permits grounding one side of the crystal, and makes available the full r-f voltage across the crystal for excitation to the next stage.

(C) shows a modified Pierce which is electron coupled to a tank delivering high harmonic output. Closing switch SW grounds the screen to r-f, and the oscillator then may be used as a "tuned plate" oscillator of the type illustrated in Figure 6-B for output on the fundamental crystal frequency. Some beam tetrodes do not work well with SW open in this circuit. A pentode having high transconductance is recommended.

rent for a given crystal is directly proportional to the r-f voltage across C_1 . This voltage may be measured by means of a vacuum tube voltmeter having a low input capacitance, and such a measurement is a more pertinent one than a reading of r-f current by means of a thermogalvanometer inserted in series with one of the leads to the crystal holder.

The function of a crystal is to provide accurate frequency control, and unless it is used in such a manner as to take advantage of its inherent high stability, there is no point in using a crystal oscillator. For this reason a crystal oscillator should not be run at high plate input in an attempt to obtain considerable power directly out of the oscillator, as such operation will cause the crystal to heat, with resultant frequency drift and possible fracture.

6-3 Crystal Oscillator Circuits

Considerable confusion exists as to nomenclature of crystal oscillator circuits, due to a tendency to name a circuit after its discoverer. Nearly all the basic crystal oscillator circuits were either first used or else developed independently by G. W. Pierce, but he has not been so credited in all the literature.

Use of the crystal oscillator in master oscillator circuits in radio transmitters dates back to about 1924 when the first application articles appeared.

The Pierce Oscillator The circuit of 6 A is the simplest crystal oscillator circuit. It is one of those developed by Pierce, and is generally known among amateurs as the "Pierce oscillator". The crystal simply replaces the tank circuit in a Colpitts or ultra-audion oscillator. The r-f excitation available to the next stage is low, being somewhat less than that developed across the crystal. Capacitor C_1 will make more of the voltage across the crystal available for excitation, and sometimes will be found necessary to ensure oscillation. Its value is small, usually approximately equal to or slightly greater than the stray capacitance from the plate circuit to ground (including the grid of the stage being driven).

If the r-f choke has adequate inductance, a crystal (even a harmonic cut crystal) will almost invariably oscillate on its fundamental. The Pierce oscillator therefore cannot be used with harmonic cut crystals.

The circuit at (B) is the same as that of (A) except that the plate instead of the cathode is operated at ground r-f potential. All of the r-f voltage developed across the crystal is available for excitation to the next stage, but still is low for reasonable values of crystal current. For best operation a tube with low heater-cathode capacitance is required. Excitation for the next stage may also be taken from the cathode when using this circuit.

The circuit at (C) is an electron coupled Pierce oscillator which delivers higher excitation voltage at two or three times the fundamental crystal frequency than the r-f voltage developed across the crystal. For "straight through" operation on the crystal frequency, SW should be closed, converting the circuit to that of Figure 7B. A pentode tube with very high transconductance and a screen configuration which permits a fair amount of screen current will give optimum operation on harmonics. The screen acts as the anode of a triode oscillator when SW is open, and some of the "beam" tetrodes draw too little screen current to do the job. A type 6AG7 tube will work nicely even with crystals having rather poor activity. A 6F6 will work with crystals having normal activity.

Tuned-Plate Crystal Oscillator The circuit shown in Figure 7A is also one used by Pierce, but is more widely referred to as the "Miller" oscillator. To avoid confusion, we shall refer to it as the "tuned-plate" crystal oscillator. It is essentially an Armstrong or "tuned plate-

tuned grid" oscillator with the crystal replacing the usual L-C grid tank. The plate tank C_1-L_1 must be tuned to a frequency slightly higher than the anti-resonant (parallel resonant) frequency of the crystal. Whereas the Pierce circuits of Figure 6 will oscillate at (or very close to) the anti-resonant frequency of the crystal, the circuits of Figure 7 will oscillate at a frequency a little above the anti-resonant frequency of the crystal.

The diagram shown in Figure 7A is the basic circuit. The most popular version of the tuned-plate oscillator employs a pentode or beam tetrode with cathode bias to prevent excessive plate dissipation when the circuit is not oscillating. The cathode resistor is optional. Its omission will reduce both crystal current and oscillator efficiency, resulting in somewhat more output for a given crystal current. The tube usually is an audio or video type beam pentode or tetrode, the plate-grid capacity of such tubes being sufficient to ensure stable oscillation but not so high as to offer excessive feedback with resulting high crystal current. The 6V6 makes an excellent all-around tube for this type circuit.

When a harmonic cut crystal is employed and it is desired to obtain operating frequency excitation with the minimum number of tubes, a 6AG7 in the circuit of Figure 7C is suitable. However, as tubes are relatively cheap, and no saving in tank circuits is realized, it usually is preferable to use a tuned-plate oscillator such as that shown at (B) together with the required number of frequency multiplier stages.

Special Harmonic Oscillators Appreciable harmonic output may be obtained from a number of crystal oscillators which are simply variations of either Figure 7C or Figure 6C. The most common ones simply have the screen of the tube by-passed to ground for r.f., with the r-f choke or tuned tank moved from the screen to the cathode circuit. In the latter class is the "tritet" circuit widely employed by amateurs for a number of years (Figure 7D). The only advantage of grounded screen operation is that "straight through" operation on the fundamental crystal frequency is improved; in fact, the "hot" screen circuit of Figure 6C should be employed only where harmonic output is desired. The circuit of Figure 7E, however, gives moderate output with light crystal loading on the fundamental, second harmonic, and third harmonic, and fair output on the fourth harmonic.

Whereas a 6AG7 pentode is recommended for Figure 7C, a beam tetrode is preferable for Figure 7D unless the pentode has the suppressor brought out separately so that it may be connected to ground instead of to the cathode inside the tube. If the suppressor is connected to the cathode inside the tube undesirable feedback will result, as the screen then no longer shields the control grid from the plate.

Crystal Oscillator Tuning The tunable circuits of all oscillators illustrated should be tuned for maximum output as indicated by maximum excitation to the following stage, except that the oscillator plate tank of tuned-plate oscillators (Figure 7A, Figure 7B, etc.) should be backed off slightly towards the low capacitance side from maximum output, as the oscillator then is in a more stable condition and sure to "take off" immediately when power is applied. This is especially important when the oscillator is keyed, as for break-in c-w operation.

Crystal Switching It is desirable to keep stray shunt capacitances in the crystal circuit as low as possible, regardless of the oscillator circuit. If a selector switch is used, this means that both switch and crystal sockets must be placed close to the oscillator tube socket. This is especially true of harmonic-cut crystals operating on a comparatively high frequency. In fact, on the highest frequency crystals it is

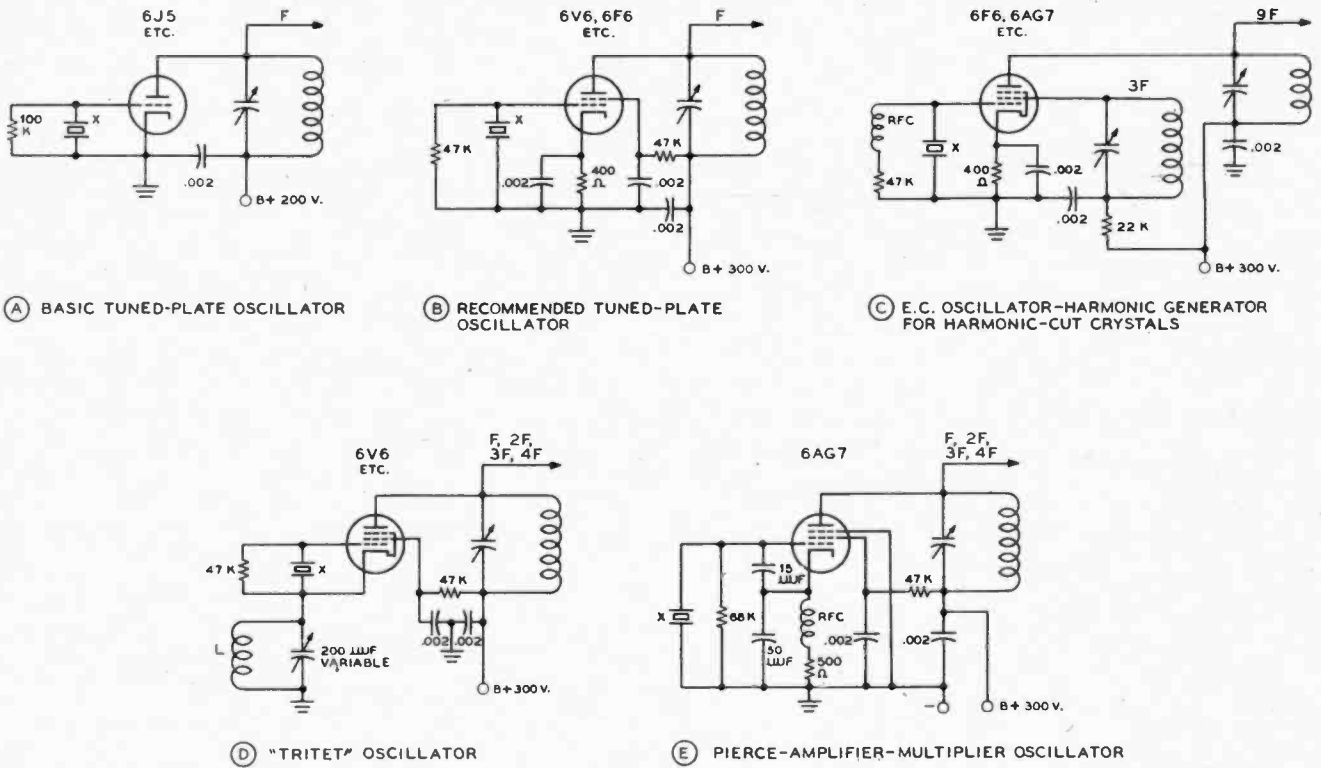

Figure 7.

BASIC TUNED-PLATE CRYSTAL OSCILLATOR AND VARIATIONS.

- (A) shows the basic "tuned-plate" oscillator. The plate tank must be tuned to a frequency slightly higher than that of the crystal in order to obtain the proper phase angle in the feedback voltage.
- (B) shows the tuned-plate oscillator as it is most commonly used. A video or a-f power pentode or tetrode permits high output with relatively low crystal current. The cathode resistor prevents excessive plate current when the stage is not oscillating.
- (C) shows an electron-coupled oscillator of the tuned-plate type for use with harmonic-type crystals when it is desired to obtain a high order of frequency multiplication directly in the crystal stage. A third-harmonic crystal is assumed so that "3F" on the drawing represents the "working-frequency" of the crystal, the fundamental of the crystal being of no concern in this type of circuit.
- (D) shows another version of the tuned-plate oscillator. The screen acts as the anode in the oscillator portion, coupling to the plate being via the electron stream. Care must be taken when using this circuit to insure that the 200- μ fd. variable capacitor is set at as high a value as will give stable oscillation; if this capacitance is allowed to become too low—or if the cathode tank is allowed to tune to a frequency as high as that of the crystal—fracture of the crystal is likely to result.
- (E) shows an improved oscillator-multiplier circuit which is quite easy on crystals, has no circuit adjustment other than the output tank, and which operates straight through on the crystal frequency without any danger of fracture. The crystal itself oscillates in a Colpitts circuit, with electron coupling to the output circuit on any desired harmonic. Tubes such as the 6L6, 6V6, and 7C5 may be used if desired, but the crystal current is somewhat higher than with the 6AG7 when the output circuit is tuned to the crystal frequency.

preferable to use a turret arrangement for switching, as the stray capacitances can be kept lower.

Crystal Oscillator Keying When the crystal oscillator is keyed, it is necessary that crystal activity and oscillator-tube transconductance be moderately high, and that oscillator loading and crystal shunt capacitance be low. Below 2500 kc. and above 6 Mc. these considerations become especially important. Sometimes a low-frequency crystal showing good activity will not follow rapid keying, the reasons for which are not fully understood. A similar crystal of the same order of Q and activity often will key satisfactorily in the same circuit.

6-4 Radio Frequency Amplifiers

The output of the oscillator stage in a transmitter (whether it be self-controlled or crystal controlled) must be kept down to a fairly low level to maintain stability and to maintain a factor of safety from fracture of the crystal when one is used. The low power output of the oscillator is brought up to the desired power level by means of radio-frequency amplifiers. The two classes of r-f amplifiers that find widest application in radio transmitters are the Class B and Class C types.

Methods for determining the correct operating conditions for various types of radio-frequency amplifiers are discussed in detail, with illustrative examples, in Chapter 4.

The Class B Amplifier Class B amplifiers are used in a radio-telegraph transmitter when maximum power gain is desired in a particular stage. A Class B amplifier operates with cutoff bias and a comparatively small amount of excitation. Power gains of 20 to 200 or so are obtainable in a well-designed Class B amplifier. The plate efficiency of a Class B c-w amplifier will run around 65 per cent.

The Class B Linear Another type of Class B amplifier is the Class B linear stage as employed in radiophone work. This type of amplifier is used to increase the level of a modulated carrier wave, and depends for its operation upon the linear relation between excitation voltage and output voltage. Or, to state the fact in another manner, the power output of a Class B linear stage varies linearly with the square of the excitation voltage.

The Class B linear amplifier is operated with cutoff bias and a small value of excitation, the actual value of exciting power being such that the power output under carrier conditions is one-fourth of the peak power capabilities of the stage. Class B linears are very widely employed in broadcast and commercial installations, but are comparatively uncommon in amateur application, since tubes with high plate dissipation are required for moderate output. The carrier efficiency of such an amplifier will vary from approximately 30 per cent to 35 per cent.

The Class C Amplifier Class C amplifiers are very widely used in all types of transmitters. Good power gain may be obtained (values of gain from 3 to 20 are common) and the plate circuit efficiency may be, under certain conditions, as high as 85 per cent. Class C amplifiers operate with considerably more than cutoff bias and ordinarily with a large amount of excitation as compared to a Class B amplifier. The bias for a normal Class C amplifier is such that plate current on the stage flows for approximately 120° of the 360° excitation cycle. Class C amplifiers are used in transmitters where a fairly large amount of excitation power is available and good plate circuit efficiency is desired.

Plate Modulated Class C The characteristic of a Class C amplifier which makes it linear with respect to changes in plate voltage is that which allows such an amplifier to be *plate modulated* for radiotelephony. Through the use of higher bias than is required for a c-w Class C amplifier and greater excitation, the linearity of such an amplifier may be extended from zero plate voltage to twice the normal value. The output power of a Class C amplifier, adjusted for plate modulation, varies with the square of the plate voltage. This is the same condition that would take place if a resistor equal to the voltage on the amplifier, divided by its plate current, were substituted for the amplifier. Therefore, the stage presents a resistive load to the modulator.

Grid Modulated Class C If the grid current to a Class C amplifier is reduced to a low value, and the plate load-impedance is increased to the point where the plate dissipation approaches the rated value, such an amplifier may be grid modulated for radiotelephony. If the plate voltage is raised to quite a high value and the stage is adjusted carefully, efficiencies as high as 40 to 43 per cent with good modulation capability and comparatively low distortion may be obtained. Fixed bias is required. This type of operation is termed Class C grid-bias modulation.

Grid Excitation Adequate grid excitation must be available for Class B or Class C service. The excitation for a plate-modulated Class C stage must be sufficient to drive a normal value of d-c grid current through a grid bias supply of about 2½ times cutoff. The bias voltage preferably should be obtained from a combination of grid leak and fixed C-bias supply.

Cutoff bias can be calculated by dividing the amplification factor of the tube into the d-c plate voltage. This is the value normally used for Class B amplifiers (fixed bias, no grid leak). Class C amplifiers use from 1½ to 5 times this value, depending upon the available grid drive, or excitation, and the desired plate efficiency. Less grid excitation is needed for c-w operation, and the values of fixed bias (if greater than cutoff) may be reduced, or the value of the grid leak resistor can be lowered until normal rated d-c grid current flows.

The values of grid excitation listed for each type of tube may be reduced by as much as 50 per cent if only moderate power output and plate efficiency are desired. When consulting the tube tables, it is well to remember that the power lost in the tuned circuits must be taken into consideration when calculating the available grid drive. At very high frequencies, the r-f circuit losses may even exceed the power required for grid drive.

Readjustments in the tuning of the oscillator, buffer, or doubler circuits, will often result in greater grid drive to the final amplifier.

Link coupling between stages, particularly to the final amplifier grid circuit, normally will provide more grid drive than can be obtained from other coupling systems. The number of

turns in the coupling link, and the location of the turns on the coil, can be varied with respect to the tuned circuits to obtain the greatest grid drive for allowable values of buffer or doubler plate current. Slight readjustments sometimes can be made after plate voltage has been applied to the driver tube.

Excessive grid current damages tubes by overheating the grid structure; beyond a certain point of grid drive, no increase in power output can be obtained for a given plate voltage.

6-5 Neutralization of R. F. Amplifiers

The plate-to-grid feedback capacitance of triodes makes it necessary that they be neutralized for operation as r-f amplifiers at frequencies above about 500 kc. Those screen-grid tubes, pentodes, and beam tetrodes which have a plate-to-grid capacitance of 0.1 μfd . or less may ordinarily be operated as an amplifier without neutralization in a well-designed amplifier up to 30 Mc.

Neutralizing Circuits The object of neutralization is to cancel or "neutralize" the capacitive feedback of energy from plate to grid. There are two general methods by which this energy feedback may be eliminated: the first, and the most common method, is through the use of a capacitance bridge, and the second method is through the use of a parallel reactance of equal and opposite polarity to the grid-to-plate capacitance, to nullify the effect of this capacitance.

The capacitance-bridge method of neutralization is divided into two systems: grid neutralization and plate neutralization. The use of grid neutralization causes an amplifier to be either regenerative or degenerative. Hence, only plate neutralization (the capacitance bridge system), coil neutralization (the opposite reactance system), and Hazeltine neutralization are recommended for neutralizing a single-ended r-f amplifier stage.

Topped-Coil Plate Neutralization Figure 8A shows a circuit for the neutralization of a single-ended triode r-f amplifier by means of a tapped coil in the plate circuit. This circuit is satisfactory for frequencies below about 7 Mc. with ordinary tubes, but a considerable amount of regeneration will be found when this circuit is used on frequencies above 7 Mc. Some regeneration can be tolerated in an amplifier for c.w. use, but for phone operation, either of the split-stator circuits described in the next two paragraphs should be used.

Split-Stator Plate Neutralization Figure 8B shows the neutralization circuit which is most widely used in single-ended r-f stages. The use of a split-stator plate capacitor makes the electrical balance of the circuit substantially independent of the mutual coupling within the coil and also makes the balance independent of the place where the coil is tapped. With conventional tubes this circuit will allow one neutralization adjustment to be made on, say, 14 Mc., and this adjustment usually will hold sufficiently close for operation on all lower frequency bands.

Figure 8C shows an alternative circuit for split-stator neutralization of a single-ended amplifier stage which, with low-capacitance tubes, can be made to remain in adjustment on all bands from 54 Mc. on down in frequency. The additional balancing capacitor BC serves merely as an adjustment to keep the capacitance-to-ground exactly the same from each side of the balanced plate tank circuit.

This capacitor can be either a small adjustable one of the type commonly used for neutralization, or the relative capacitance to ground of the two sides of the circuit can be proportioned so that there is a balance. In determining the balance of the circuit, it must be remembered that the plate-to-filament

capacitance of the power amplifier tube is the main item to cause the unbalance.

If the other capacitances of the circuit are perfectly balanced with respect to ground, the capacitance of the condenser BC should be approximately equal to the plate-to-ground capacitance of the tube being neutralized. However, it is often just as convenient to unbalance the circuit wiring capacitances to ground until the additional capacitance on the neutralizing side of the circuit is about equal to that on the plate side. At the point where the plate-to-ground capacitance is exactly balanced, the amplifier will neutralize perfectly (at least as

nearly perfectly as a push-pull amplifier) and will stay neutralized on all bands for which the amplifier tubes are satisfactory.

Hazeltine Neutralization An alternative system of neutralization, wherein the neutralizing circuit is inductively coupled to one of the tank coils, is shown in Figures 8D and 8E. Figure 8D shows the plate-neutralized Hazeltine circuit, while 8E shows the grid-neutralized arrangement. In either case, it will be noticed that there is no tank current flowing through the neutralizing coil L.

In this circuit arrangement, the size of the neutralizing capacitor NC is determined by the coefficient of coupling between the tank coil and L, and upon their relative inductances. It is possible, by proper proportioning of the neutralizing coil L on each band, to make one setting of NC correct for all bands.

Push-Pull Neutralization Two tubes of the same type can be connected for *push-pull* operation so as to obtain twice as much output as that of a single tube. A push-pull amplifier, such as that shown in Figure 9A, also has an advantage in that the circuit can more easily be balanced than a single-tube r-f amplifier. The various inter-electrode capacitances and the neutralizing capacitors are connected in such a manner that the reactances on one side of the tuned circuits are exactly equal to those on the opposite side. For this reason, push-pull r-f amplifiers can be more easily neutralized in very-high-frequency transmitters; also, they usually remain in perfect neutralization when tuning the amplifier to different bands.

The circuit shown in Figure 9A is perhaps the most commonly used arrangement for a push-pull r-f amplifier stage. The rotor of the grid capacitor is grounded, and the rotor of the plate tank capacitor is allowed to float. Under certain con-

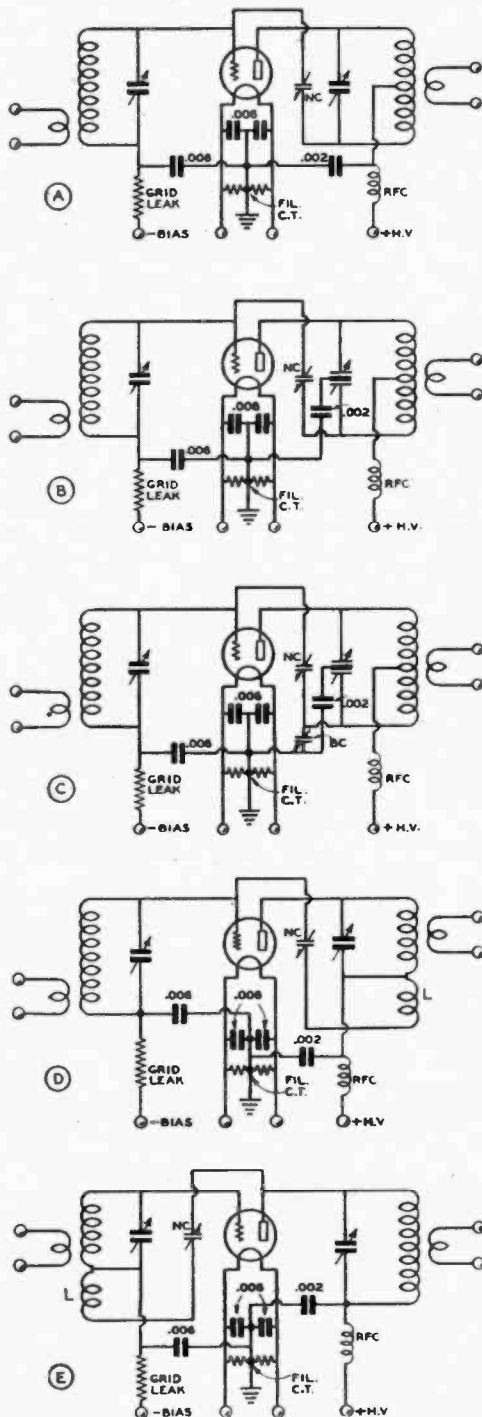

Figure 8.
COMMON NEUTRALIZATION CIRCUITS FOR SINGLE-ENDED AMPLIFIERS.

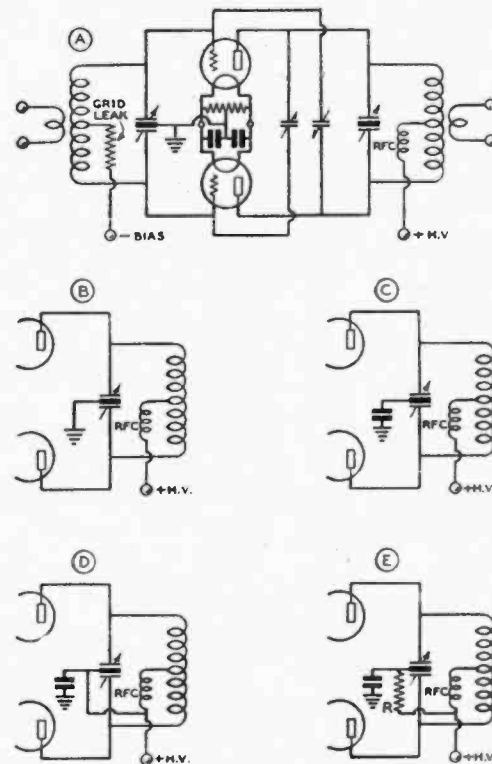

Figure 9.
CROSS NEUTRALIZED PUSH-PULL AMPLIFIER AND COMMON PLATE TANK ARRANGEMENTS.

dition, the circuit of 9B may be used (when the plate tank capacitor has a much larger voltage rating than the maximum possible peak output of the power tubes) with the rotor of the grid capacitor grounded or not, as desired. It is also possible to use a single-section grid capacitor with a tapped coil (un-bypassed) for low-frequency operation with this circuit arrangement.

Figure 9C shows an alternative arrangement for the return of the rotor of the plate tank capacitor. The by-pass capacitor from the rotor to ground can be any capacitance from .01 μ fd. down to .0005 μ fd. and even down to .0001 μ fd. for an u-h-f amplifier. For phone use, it is best to have some sort of a coupling arrangement to make the rotor of the tuning capacitor follow plate voltage fluctuations. As long as the rotor of the tuning capacitor is at the same d-c potential as the stators, there will be a much reduced chance of breakdown on modulation peaks since only the r-f potential will appear between adjacent plates in the tuning capacitor.

Figures 9D and 9E show two arrangements which tend to keep the rotor of the capacitor as nearly as possible at the same d-c potential as the stators. In Figure 9D the rotor of the capacitor and the ungrounded side of the by-pass capacitor, is merely connected to the plate supply side of the r-f choke. This is an excellent arrangement for use with moderate plate voltages but has the disadvantage that considerable stress is placed on the mica by-pass capacitor; should this capacitor break down, the plate supply will be shorted. Figure 9E shows an alternative arrangement which has the advantage that, should the mica by-pass capacitor short out, only the resistor R will be destroyed. For a mica by-pass capacitance of .001 μ fd. and a maximum 100 per cent modulation frequency of 3000 cycles, a 25,000-ohm resistor will be satisfactory for R.

Shunt or Coil Neutralization The feedback of energy from grid to plate in an unneutralized r-f amplifier is a result of the grid-to-plate capacitance of the amplifier tube. A neutralization circuit is merely an electrical arrangement for nullifying the effect of this capacitance. All the previous neutralization circuits have made use of a bridge circuit for balancing out the grid-to-plate energy feedback by feeding back an equal amount of energy of opposite phase.

Another method of eliminating the feedback effect of this capacitance, and hence of neutralizing the amplifier stage, is shown in Figure 10. The grid-to-plate capacitance in the triode amplifier tube acts as a capacitive reactance, coupling energy back from the plate to the grid circuit. If we parallel this capacitance with an inductance having the same value of reactance of opposite sign the reactance of one will cancel the reactance of the other and we will have a high-impedance tuned circuit from grid to plate.

This neutralization circuit can be used on ultra-high frequencies where other neutralization circuits are unsatisfactory. This is true because the lead length in the neutralization circuit is practically negligible. The circuit can also be used with push-pull r-f amplifiers. In this case, each tube will have its own neutralizing inductor connected from grid to plate.

The big advantage of this arrangement is that it allows the use of single-ended tank circuits with a single-ended amplifier.

The chief disadvantage of the shunt neutralized arrangement is that the stage must be reneutralized each time the stage is retuned to a new frequency sufficiently removed that the grid and plate tank circuits must be retuned to resonance. However, by the use of plug-in coils and the trimmer capacitor C in parallel with the grid-to-plate capacitance, it is possible to shift the band of operation and to trim to any frequency within the band. This trimmer capacitor, if used, must be insulated for somewhat more voltage than the tank capacitor. The .0001- μ fd. capacitor in series with the neutralizing circuit

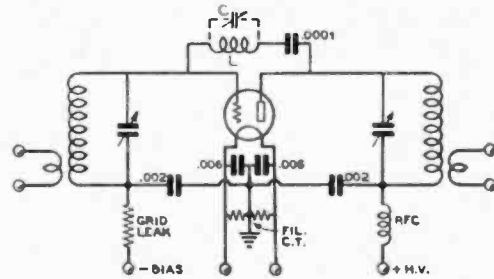

Figure 10.
COIL NEUTRALIZED AMPLIFIER.

This neutralization circuit is very effective with triode tubes on any frequency, but is particularly effective in the v-h-f range. The coil L is adjusted so that it resonates at the operating frequency with the grid-to-plate capacitance of the tube. Capacitor C may be a very small unit of the low-capacitance neutralizing type and is used to trim the circuit to resonance at the operating frequency. If some means of varying the inductance of the coil a small amount is available, the trimmer capacitor is not needed.

is merely a blocking capacitor to isolate the plate voltage from the grid circuit. The coil L will have to have a very large number of turns for the band of operation in order to be resonant with the comparatively small grid-to-plate capacitance. But since, in all ordinary cases with tubes operating on frequencies for which they were designed, the L/C ratio of the tuned circuit will be very high, the coil can use comparatively small wire, although it must be wound on air or very low-loss dielectric, and must be insulated for the sum of the plate r-f voltage and the grid r-f voltage.

6-6 Neutralizing Procedure

An r-f amplifier is neutralized to prevent self-oscillation or regeneration. A neon bulb, a flashlight lamp and loop of wire, or an r-f galvanometer can be used as a null indicator for neutralizing low-power stages. The plate voltage lead is disconnected from the r-f amplifier stage while it is being neutralized. Normal grid drive then is applied to the r-f stage, the neutralizing indicator is coupled to the plate coil, and the plate tuning capacitor is tuned to resonance. The neutralizing capacitor (or capacitors) then can be adjusted until minimum r.f. is indicated for resonant settings of both grid and plate tuning capacitors. Both neutralizing capacitors are adjusted simultaneously and to approximately the same value of capacitance when a physically symmetrical push-pull stage is being neutralized.

A final check for neutralization should be made with a d-c milliammeter connected in the grid leak or grid-bias circuit. There will be no movement of the meter reading as the plate circuit is tuned through resonance (without plate voltage being applied) when the stage is completely neutralized. The milliammeter check is more accurate than any other means for indicating complete neutralization and it also is suitable for neutralizing the stages of a high-power transmitter.

Plate voltage should be completely removed by actually opening the d-c plate circuit. (Turning off the filaments of the rectifier tubes will do the trick.) If there is a d-c return through the plate supply, a small amount of plate current will flow when grid excitation is applied, even though no primary a-c voltage is being fed to the plate transformer.

A further check on the neutralization of any r-f amplifier can be made by noting whether maximum grid current on the stage comes at the same point of tuning on the plate tuning capacitor as minimum plate current. This check is made with plate voltage on the amplifier and with normal antenna coupling. As the plate tuning capacitor is detuned slightly from resonance on either side the grid current on the stage should decrease the same amount and without any sudden

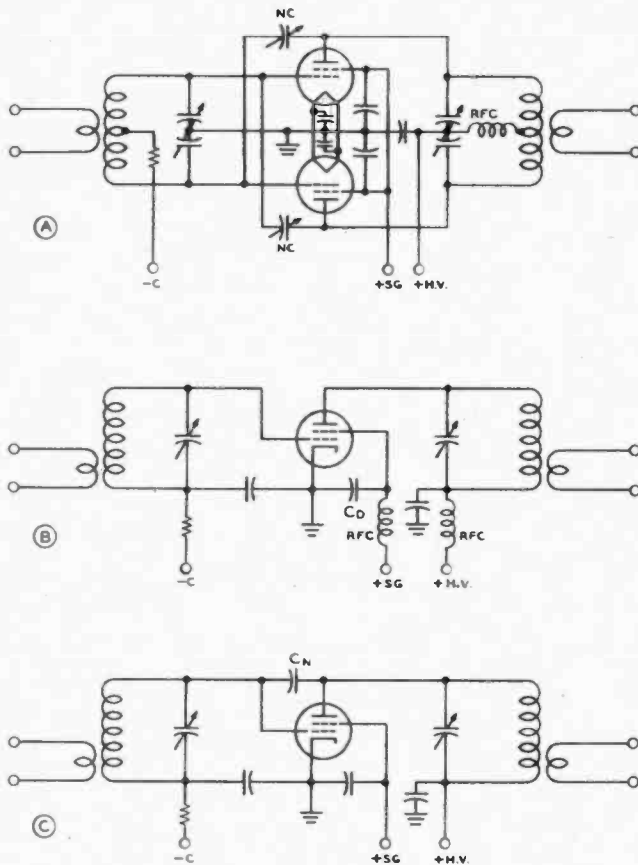

Figure 11.

NEUTRALIZING BEAM TETRODES.

As discussed in some detail in the text, beam tetrodes often require neutralization at the higher frequencies. Circuit (A) shows a conventional cross-neutralized arrangement for cancellation of the effects of residual grid-to-plate capacitance. Circuit (B) is an arrangement for use at the v.-h.-f.'s for series resonating the screen-lead inductance to ground by means of capacitor C_D . This capacitor should be a variable with a locking adjustment; it is adjusted at the frequency of operation for minimum reaction between the grid and plate circuits and the lock tightened. Circuit (C) shows an alternative arrangement for compensating the effects of screen-lead inductance in the v.-h.-f. range by means of additional capacitance connected between grid and plate on the tube.

jumps on either side of resonance. This will be found to be a very precise indication of accurate neutralization in either a triode or beam-tetrode r-f amplifier stage.

Push-pull circuits usually can be more completely neutralized than single-ended circuits at very high frequencies. In the intermediate range of from 3 to 15 Mc., single-ended circuits will give satisfactory results.

Neutralization of Screen-Grid R-F Amplifiers

Radio-frequency amplifiers using screen-grid tubes can normally be operated without any additional provision for neutralization at frequencies up to about 15 Mc., provided adequate shielding has been provided between the input and output circuits. Special u.-h.-f. screen-grid and beam tetrode tubes such as the 2E26 and 5516 in the low-power category and HK-257B, 4E27/8001, 4-125A, and 4-250A in the medium-power category can frequently be operated at frequencies as high as 100 Mc. without any additional provision for neutralization. Tubes such as the 807, HY-69, and 813 can normally be operated with good circuit design at frequencies up to 30 Mc. without any additional provision for neutralization. The 815 has been found to require neutralization in many cases at frequencies above 30 Mc., although the

829B will normally operate quite stably at 148 Mc. without neutralization.

At frequencies above those listed in the previous paragraph for each tube type, some additional provision for neutralization will quite frequently be required. Also, it has been found by experience, surprisingly enough, that a single-ended beam-tetrode r-f amplifier will often operate stably at a frequency several times as high as a push-pull r-f amplifier using the same tube type.

In most cases the simplest method of accomplishing neutralization is to use the cross-neutralized capacitance bridge arrangement as normally employed with triode tubes. The neutralizing capacitances, however, must be very much smaller than used with triode tubes, values of the order of $0.2 \mu\text{fd}$. normally being required with beam tetrode tubes. This order of capacitance is far less than can be obtained with a conventional neutralizing capacitor at minimum setting, so the neutralizing arrangement is most commonly made especially for the case at hand. Most common procedure is to bring a conductor (connected to the opposite grid) in the vicinity of the plate itself or of the plate tuning capacitor of one of the tubes. Either one or two such "capacitors" may be used, two being normally used on a higher frequency amplifier in order to maintain balance within the stage. Examples of the use of hand-fabricated neutralizing capacitors of this type are: the 815 29 and 53 Mc. FM transmitter shown in Chapter 23 which uses merely a pair of wires connected to adjacent grids and brought near the plates of the 815, the push-pull 4-250A amplifier shown in Chapter 22 which uses panel bushings mounted on mycalex with rod going through the bushings and connected to opposite grids as neutralizing capacitors, and the push-pull 807 or HY-69 amplifier shown in Chapter 22 which uses a single wire running from one grid which may be brought into the vicinity of either 807 plate.

The provision discussed in the previous paragraph is for neutralization of the small, though still important at the higher frequencies, grid-to-plate capacitance of beam-tetrode tubes. However, in the vicinity of the upper-frequency limit of each tube type the inductance of the screen lead of the tube becomes of considerable importance. With a tube operating at a frequency where the inductance of the screen lead is appreciable, the screen will allow a considerable amount of energy leak-though from plate to grid even though the socket terminal on the tube is carefully by-passed to ground. This condition takes place because, even though the socket pin is by-passed, the reactance of the screen lead will allow a moderate amount of r-f potential to appear on the screen itself inside the electrode assembly in the tube. This effect has been reduced to a very low amount in such tubes as the Hytron 5516, the 829B, and the Eimac 4X150A and 4X500A but it is still quite appreciable in most beam-tetrode tubes.

The effect of screen-lead inductance on the stability of a stage can be eliminated at any particular frequency by one of two methods. These methods are: (1) Tuning out the screen-lead inductance by series resonating the screen lead inductance with a capacitor to ground. This method is illustrated in Figure 11B and is commonly employed in commercially-built equipment for operation on a narrow frequency band in the range above about 75 Mc. The other method (2) is illustrated in Figure 11C and consists in feeding back additional energy from plate to grid by means of a small capacitor connected between these two elements. Note that this capacitor is connected in such a manner as to increase the effective grid-to-plate capacitance of the tube. This method has been found to be effective with 807 tubes in the range above 50 Mc. and with tubes such as the 4-125A and 4-250A in the vicinity of their upper frequency limits.

Note that both these methods of stabilizing a beam-tetrode

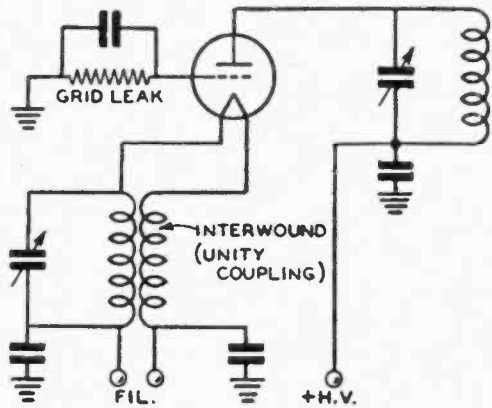

Figure 12.
GROUNDING GRID AMPLIFIER.

This type amplifier requires no neutralization, but can be used successfully only with certain type tubes. For heater-cathode type tubes, the cathode is connected to one side of the filament.

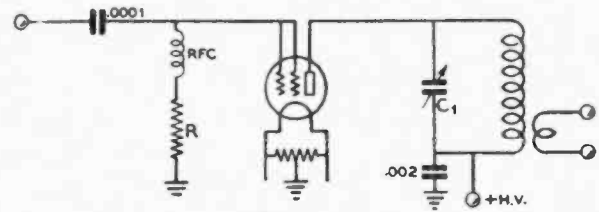

Figure 13.
CONVENTIONAL FREQUENCY DOUBLER.

A high- μ dual grid triode makes an excellent frequency doubler. The plate tank is tuned to twice the excitation frequency. High bias and excitation are required for good efficiency.

v-h-f amplifier stage are suitable only for operation over a relatively narrow band of frequencies such as the 50 to 54 Mc. band or the 144 to 148 Mc. band. At lower frequencies both these expedients for reducing the effects of screen-lead inductance will tend to increase the tendency toward oscillation of the amplifier stage.

The push-pull 807 r-f amplifier shown in Chapter 22 is a case which shows how the small capacitance between one grid and the plate of the same tube can be used to stabilize the amplifier by reducing the effect of screen-lead inductance on the 50-54 Mc. band, but that on the lower-frequency bands it is necessary to couple the wire from the grid to the opposite plate in order to reduce the effect of the residual grid-to-plate capacitance within the tubes.

Neutralizing Problems When a stage cannot be completely neutralized, the difficulty can be traced to one or more of the following causes: (1) Filament leads

not by-passed to the common ground point of that particular stage. (2) Ground lead from the rotor connection of the split-stator tuning capacitor to filament open or too long. (3) Neutralizing capacitors in a field of excessive r.f. from one of the tuning coils. (4) Electromagnetic coupling between grid and plate coils, or between plate and preceding buffer or oscillator circuits. (5) Insufficient shielding or spacing between stages, or between grid and plate circuits in compact transmitters. (6) Shielding placed too close to plate circuit coils, causing induced currents in the shields. (7) Parasitic oscillations when plate voltage is applied. The cure for the latter is mainly a matter of cut and try—rearrange the parts, change the length of grid or plate or neutralizing leads, insert a parasitic choke in the grid lead or leads, or eliminate the grid r.f. chokes which may be the cause of a low-frequency parasitic (in conjunction with plate r.f. chokes). See *Parasitic Oscillation in R.F. Amplifiers* in Section 6-11 of this chapter.

6-7 Grounded Grid Amplifiers

Certain triodes, some by accident and some by design, have a grid configuration and lead arrangement which results in very low plate to filament capacitance when the control grid is grounded, the grid acting as an effective shield much in the manner of the screen in a screen-grid tube.

By connecting such a triode in the circuit of Figure 12, taking the usual precautions against stray capacitive and inductive coupling between input and output leads and components, a stable power amplifier is realized which requires no neutralization.

A detailed discussion of the operation of grounded-grid r-f power amplifiers, along with the method of design and design data on a typical stage, has been given in Chapter 4, Section 4-14.

At ultra-high frequencies, where it is difficult to obtain satisfactory neutralization with conventional triode circuits (particularly when a wide band of frequencies is to be covered), the grounded-grid arrangement is about the only practicable means of employing a triode amplifier. However, it is seldom used otherwise, because it exhibits various unusual characteristics some of which are undesirable.

Because of the large amount of degeneration inherent in the circuit, considerably more excitation is required than if the same tube were employed in a conventional grounded-cathode circuit. The degeneration can be minimized by utilizing a tube with a high amplification factor (on the order of 50), and tubes designed for grounded grid operation usually will be found to have a high amplification factor.

The additional power required to drive a triode in a grounded-grid amplifier is not lost, as it shows up in the output circuit and adds to the power delivered to the load. But nevertheless it means that a larger driver stage is required for an amplifier of given output, because a moderate amount of power is delivered to the amplifier load by the driver stage of a grounded-grid amplifier.

6-8 Frequency Multipliers

Quartz crystals and variable-frequency oscillators are not ordinarily used for direct control of the output of high-frequency transmitters. *Frequency multipliers* are usually employed to multiply the frequency to the desired value. These multipliers operate on exact multiples of the excitation frequency; a 3.6-Mc. crystal oscillator can be made to control the output of a transmitter on 7.2 or 14.4 Mc., or even on 28.8 Mc., by means of one or more frequency multipliers. When used at twice frequency, they are often termed *frequency doublers*. A simple doubler circuit is shown in Figure 13. It consists of a vacuum tube with its plate circuit tuned to *twice* the frequency of the grid driving circuit. This doubler can be excited from a crystal oscillator or another multiplier or amplifier stage.

Doubling is best accomplished by operating the tube with high grid bias. The grid circuit is driven approximately to the normal value of d-c grid current through the r-f choke and grid-leak resistor, shown in Figure 13. The resistance value generally is from two to five times as high as that used with the same tube for straight amplification. Consequently, the grid bias is several times as high for the same value of grid current.

Neutralization is seldom necessary in a doubler circuit, since the plate is tuned to twice the frequency of the grid circuit. The impedance of the grid driving circuit is very low at the doubling frequency, and thus there is little tendency for self-excited oscillation.

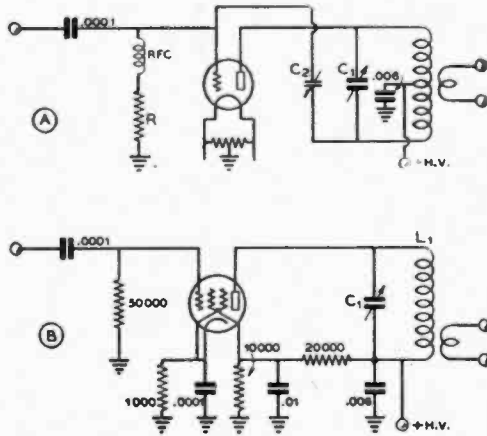

Figure 14.

COMMON FREQUENCY MULTIPLIER CIRCUITS.

(A) shows a circuit which may be used either as a neutralized straight amplifier or a regenerative frequency multiplier. (B) shows a pentode multiplier with cathode regeneration, a result of the undersized cathode bypass capacitor and large cathode resistor.

A doubler can either be neutralized or made more regenerative by adjusting C_2 in the circuit shown in Figure 14A.

When capacitor C_2 is of the proper value to neutralize the plate-to-grid capacitance of the tube, the plate circuit can be tuned to twice the frequency (or to the same frequency) as that of the source of grid drive; the tube can be operated either as a neutralized amplifier or doubler. The capacity of C_2 can be increased so that the doubler will become *regenerative*, if the r-f impedance of the external grid driving circuit is high enough at the output frequency of the stage.

Frequency doublers require bias of several times cutoff; high- μ tubes therefore are desirable for this type of service. Tubes which have amplification factors from 20 to 200 are suitable for doubler circuits. Tetrodes and pentodes make excellent doublers. Low- μ triodes, having amplification constants of from 3 to 10, are not applicable for doubler service. In extreme cases the grid voltage must be as high as the plate voltage for efficient doubling action.

Angle of Flow in Frequency Multipliers The angle of plate current flow in a frequency multiplier is a very important factor in determining the efficiency. As the angle of flow is decreased for a given value of grid current, the efficiency increases. To reduce the angle of flow, higher grid bias is required so that the grid excitation voltage will exceed the cutoff value for a shorter portion of the exciting-voltage cycle. For a high order of efficiency, frequency doublers should have an angle of flow of 90 degrees or less, triplers 60 degrees or less, and quadruplers 45 degrees or less. Under these conditions the efficiency will be on the same order as the reciprocal of the harmonic on which the stage operates. In other words the efficiency of a doubler will be approximately $\frac{1}{2}$ or 50 per cent, the efficiency of a tripler will be approximately $\frac{1}{3}$ or 33 per cent and that of a quadrupler will be about 25 per cent. With good stage design the efficiency can be somewhat greater than these values, but as the angle of flow is made greater than these limiting values, the efficiency falls off rapidly. The reason is apparent from a study of Figure 15.

The pulses ABC, EFG, JKL illustrate 180-degree excitation pulses under Class B operation, the solid straight line indicating cut-off bias. If the bias is increased by N times, to the value indicated by the dotted straight line, and the excitation increased until the peak r-f voltage with respect to ground is the same as before, then the excitation frequency can be cut

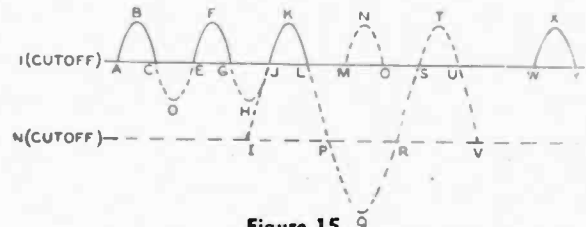

Figure 15.

ILLUSTRATING FREQUENCY DOUBLER ACTION (SEE TEXT)

in half and the effective excitation pulses will have almost the same shape as before. The only difference is that every other pulse is missing; MNO simply shows where the missing pulse would go. However, if the Q of the plate tank circuit is high, it will have sufficient "flywheel" effect to carry over through the missing pulse, and the only effect will be that the plate input and r-f output at optimum loading drop to approximately half. As the input frequency is half the output frequency, an efficient frequency doubler is the result.

By the same token, a tripler or quadrupler can be analyzed, the tripler skipping two excitation pulses and the quadrupler three. In each case the excitation pulse ideally should be short enough that it does not exceed 180 degrees at the output frequency; otherwise the excitation actually is *bucking* the output over a portion of the cycle.

In actual practice, it is found uneconomical to provide sufficient excitation to run a tripler or quadrupler in this fashion. Usually the excitation pulses will be at least 90 degrees at the exciting frequency, with correspondingly low efficiency, but it is more practicable to accept the low efficiency and build up the output in succeeding amplifier stages. The efficiency can become quite low before the power gain becomes less than unity.

Distorted Drive Multiplier By altering the shape of the exciting voltage from its usual sine-wave form at the exciting frequency, it is possible to decrease the angle of flow and thus increase the efficiency of a doubler or quadrupler without resorting to increases in the excitation voltage and bias.

The angle of flow may be decreased by adding some properly phased third-harmonic voltage to the excitation. The result of adding the third-harmonic voltage to the fundamental is shown graphically in Figure 16. As shown by the dotted curve, E_3 , when the fundamental and third-harmonic voltages are added in the proper phase, the result is a grid excitation voltage having a peaked wave form, exactly what is required for high-efficiency frequency multiplying. The method by which the third harmonic is added is shown in Figure 17. A small, center-tapped tank circuit tuned to three times the driver frequency is placed between the driver plate and the coupling condenser to the frequency-multiplier stage. The center tap of this coil is connected to the "hot" end of the driver plate tank, which remains tuned to the fundamental frequency. The third-harmonic tank circuit can be tuned accurately to frequency by coupling to it a small, low-current dial lamp in a loop of wire and tuning for maximum brilliancy. An absorption wavemeter may be coupled to the third-harmonic tank after it has been tuned, to make sure that it is on the correct harmonic. The tuning of this circuit is not critical.

When quadrupling the addition of the peaking circuit will result in a tendency of the multiplier to self-oscillate at a dial setting where the output tuned circuit is tuned to the same frequency as the peaking circuit unless a well screened r-f tetrode or pentode is used in place of the triode illustrated.

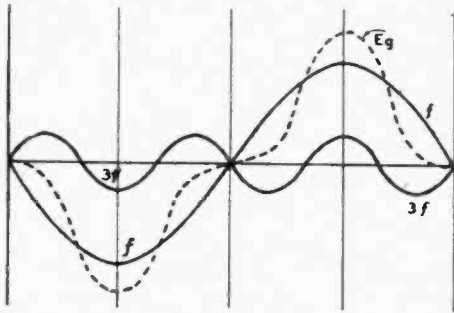

Figure 16.

PEAKED WAVEFORM OBTAINED BY ADDITION OF FUNDAMENTAL AND THIRD-HARMONIC ENERGY IN PROPER PHASE.

When fundamental frequency (f) energy and third-harmonic ($3f$) energy are added in the proper phase the result is a peaked waveform as shown by E_g . This peaked waveform, when used as excitation for a frequency multiplier stage, gives considerably higher plate efficiency than when sine-wave excitation voltage is applied to the grid of the tube.

Push-Push Multipliers Two tubes can be connected in parallel to give twice the output of a single-tube doubler. If the grids are driven *out* of phase instead of *in* phase, the tubes then no longer work simultaneously, but rather one at a time. The effect is to fill in the missing pulses (Figure 15). Not only is the output doubled, but several advantages accrue which cannot be obtained by straight parallel operation.

Chief among these is the effective neutralization of the fundamental and all *odd* harmonics, an advantage when spurious emissions must be minimized. Another advantage is that when the available excitation is low and excitation pulses exceed 90 degrees, the output and efficiency will be greater than for the same tubes connected in parallel.

The same arrangement may be used as a quadrupler, with considerably better efficiency than for straight parallel operation, because seldom is it practicable to supply sufficient excitation to permit 45 degree excitation pulses. As pointed out above, the push-push arrangement exhibits better efficiency than a single ended multiplier when excitation is inadequate for ideal multiplier operation.

A typical push-push doubler is illustrated in Figure 18. When high transconductance tubes are employed, it is necessary to employ a split-stator grid tank capacitor to prevent self oscillation; with well screened tetrodes or pentodes having medium values of transconductance, a split-coil arrangement with a single-section capacitor may be employed (the center tap of the grid coil being by-passed to ground).

Push-Pull Frequency Triplers It is frequently desirable in the case of u-h-f and v-h-f transmitters that frequency multiplication stages be

balanced with respect to ground. Further it is just as easy in most cases to multiply the crystal or v-f-o frequency by powers of three rather than multiplying by powers of two as is frequently done on lower frequency transmitters. Hence the use of push-pull triplers has become quite prevalent in both commercial and amateur v-h-f and u-h-f transmitter designs. Such stages are balanced with respect to ground and appear in construction and on paper essentially the same as a push-pull r-f amplifier stage with the exception that the output tank circuit is tuned to three times the frequency of the grid tank circuit. A circuit for a push-pull tripler stage is shown in Figure 19, and several push-pull tripler stages are shown in the transmitters described in Chapter 23.

A push-pull tripler stage has the further advantage in amateur work that it can also be used as a conventional push-pull r-f amplifier merely by changing the grid and plate coils

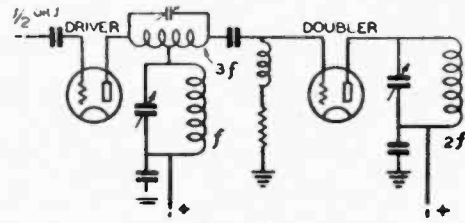

Figure 17.

CIRCUIT FOR COMBINING FUNDAMENTAL AND THIRD-HARMONIC ENERGY IN PROPER PHASE FOR PEAKED WAVEFORM.

The small third-harmonic tank circuit connected as shown adds the fundamental and third harmonic in the proper phase relation for producing a peaked excitation waveform on the grid of the doubler. This circuit arrangement may also be used to feed the grid of a straight amplifier instead of a doubler, resulting in an effective reduction in the angle of plate-current flow on the amplifier stage and a consequent increase in amplifier plate-circuit efficiency.

so that they tune to the same frequency. This is of some advantage in the case of operating in the 50-Mc. band with 50-Mc. excitation, and then changing the plate coil to tune to 144 Mc. for operation of the stage as a tripler from excitation on 48 Mc. This circuit arrangement is excellent for operation with push-pull beam tetrodes such as the 815 and 829B, although a pair of tubes such as the 2E25, 2E26, or 5516 could just as well be used if proper attention were given to the matter of screen-lead inductance.

6-9 Tank-Circuit Capacitances

It is necessary that the proper value of Q be used in the plate tank circuit of any r-f amplifier. A brief discussion of this matter has been given in Section 4-12 of Chapter 4. However, the following section has been devoted to a more thorough treatment of the subject, and charts and curves are given to assist the reader in the determination of the proper L/C ratio to be used in a radio-frequency amplifier stage.

A Class C amplifier draws plate current in the form of very distorted pulses of short duration. Such an amplifier is always operated into a tuned inductance-capacitance or tank circuit which tends to smooth out these pulses, by its storage or "tank" action, into a sine wave of radio-frequency output. Any waveform distortion of the carrier frequency results in harmonic interference in higher-frequency channels.

A Class A r-f amplifier would produce a sine wave of radio-frequency output if its exciting waveform were also a sine wave. However, a Class A amplifier stage converts its d-c input to r-f output by acting as a variable resistance, and therefore heats considerably. A Class C amplifier when driven hard with short pulses at the peak of the exciting waveform acts as an electronic switch, and therefore can convert con-

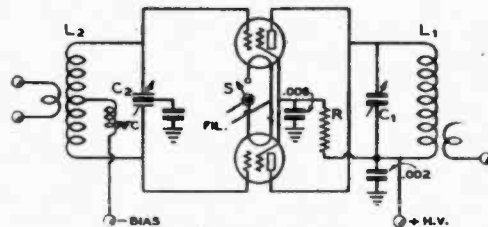

Figure 18.

PUSH-PUSH MULTIPLIER CIRCUIT.

In this type of doubler or quadrupler the grids are connected in push-pull and the plates are connected in parallel. A pair of triodes, a dual triode, or a pair of pentodes or tetrodes may be used. In the diagram shown, the heater of one of the tubes may be opened and the other tube operated as a neutralized amplifier, the other tube acting as the neutralizing capacitor.

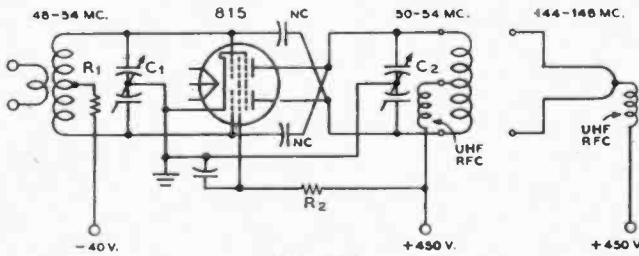
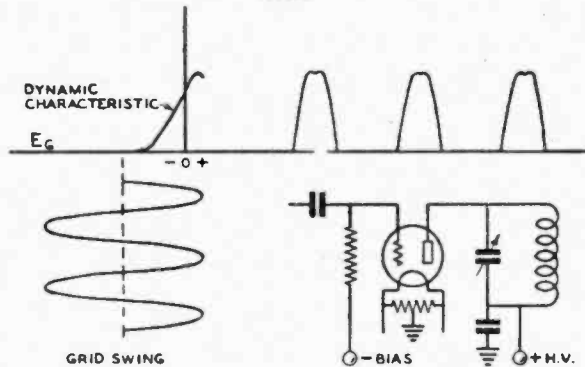

Figure 19.

PUSH-PULL 815 AMPLIFIER-TRIPLER.

Illustrating the circuit for a push-pull tripler. If the neutralizing capacitors NC are used as shown the circuit may be used as an amplifier or as a tripler to the third harmonic simply by installing the appropriate plate tank coil. Resistor R_1 should be 5000 ohms at 2 watts and resistor R_2 should be 10,000 ohms at 10 watts.



CLASS C AMPLIFIER PLATE CURRENT WAVEFORM

Figure 20.

siderable d-c input to r-f output with little heating. A tube in a Class C amplifier will deliver many times as much power output for a given plate loss as will the same tube in a Class A amplifier.

The tuned circuit in the plate of a Class C amplifier must have a good flywheel effect in order to furnish a sine-wave output to the antenna when it is receiving energy in the form of very distorted pulses such as shown in Figure 20. The LC circuit fills in power over the complete r-f cycle, providing the L/C ratio is sufficiently low. The flywheel effect is generally defined as the ratio of radio-frequency volt-amperes to actual power output in watts, or VA/W. This is equivalent to Q and should not be much less than 4π , or 12.5, for a single ended Class-C amplifier. At this value of VA/W or Q, one-half of the stored energy in the LC circuit is absorbed by the antenna. If a lower value of Q is used, the storage power is insufficient to produce a sine (undistorted) wave output to the antenna and power will be wasted in radiation of harmonics.

Too high a value of VA/W or Q will result in excessive circulating r-f current loss in the LC circuit and lowered output to the antenna.

Harmonic Radiation vs. Q

Opinions vary as to the optimum value of Q, but a careful analysis of the whole problem seems to indicate that a value of 12 is suitable for most amateur or commercial c.w. or FM transmitters. A value of 15 to 20 will result in less harmonic radiation at the expense of a little additional heat power loss in the tank or LC circuit, and will give improved operation for AM radiotelephony. The charts shown have been calculated for an operating value of $Q = 12$. For push-pull operation only half the Q is required to give the same flywheel effect.

The curves shown in Figure 21 indicate the sharp increase

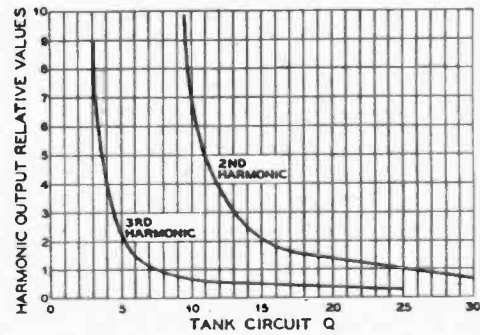

Figure 21.

HARMONIC OUTPUT PLOTTED AGAINST TANK CIRCUIT Q.

in harmonic output into the antenna circuit for low values of Q. The curve for the second harmonic rises nearly vertically for Q values of less than 10. The third harmonic is not seriously large for values of Q over 4 or 5. These curves show that push-pull amplifiers may be operated at lower values of Q, since the second harmonic is cancelled to a large extent if there is no capacitive or unbalanced coupling between the tank circuit and the antenna feeder system.

Effect of Load on Q

The Q of a circuit depends upon the resistance in series with the capacitance and inductance. This series resistance is very low for a low-loss coil not loaded by an antenna circuit. The value of Q may be from 100 to 600 under these conditions. Coupling an antenna circuit has the effect of increasing the series resistance, though in this case the power is consumed as useful radiation by the antenna. Mathematically, the antenna increases the value of R in the expression $Q = \omega L/R$ where L is the coil inductance and ω is the term $2\pi f$, f being in cycles per second.

The coupling from the final tank circuit to the antenna or antenna transmission line can be varied to obtain values of Q from perhaps 3 at maximum coupling to a value of Q equal to the unloaded Q of the circuit at zero antenna coupling. This value of unloaded Q can be as high as 500 or 600, as mentioned in the preceding paragraph. However, the value of $Q = 12$ for c.w. or FM (or $Q = 15$ to 20 for AM phone) will not be obtained at values of normal d-c plate current in the Class C amplifier stage unless the C-to-L ratio in the tank circuit is correct for that frequency of operation.

The capacitance values of C_1 , C_2 , and C_3 shown in Figures 22, 23, and 24 are for the total capacitance across the tank inductor. This value includes the tube interelectrode capacitances, distributed coil capacitance, wiring capacitances, one-half the value of neutralizing capacitance (if used), in addition to the actual plate tuning capacitor capacitance. If a split-stator plate tuning capacitor is used, the effective capacitance is equal approximately to one-half the value of each section, since the two sections are in series across the tank circuit. The value is actually slightly greater than one half due to the mutual capacitance between the two sections which exists without the presence of the stator of the capacitor. Total circuit stray capacitances may vary from perhaps 4 to 30 μfd . for the variation in tubes commonly used in low-power and medium-power transmitters.

Due to the unknowns involved in determining circuit stray capacitances it is sometimes more convenient to determine the value of L required for the proper circuit Q (by the method discussed in Section 4-12) and then to vary the tuned circuit capacitance until resonance is reached. This method is most frequently used in obtaining proper circuit Q in commercial transmitters.

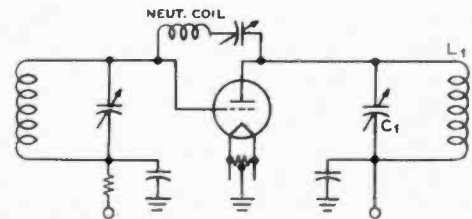
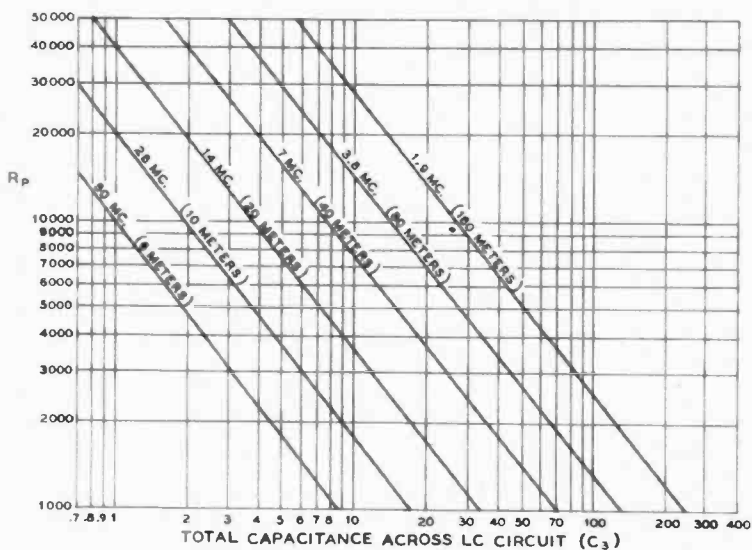
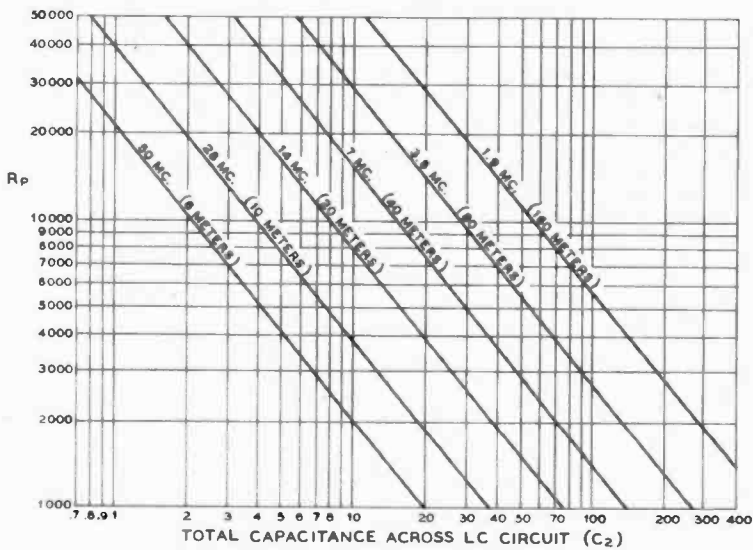
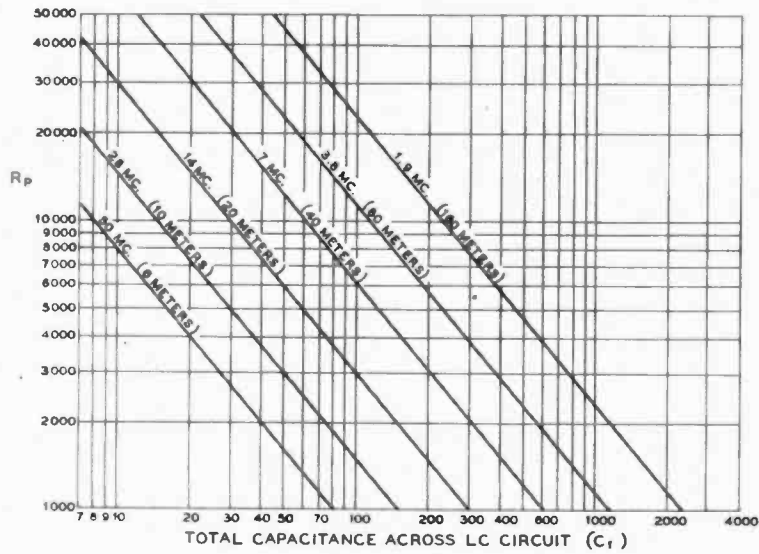

(A) COIL NEUTRALIZED AMPLIFIER

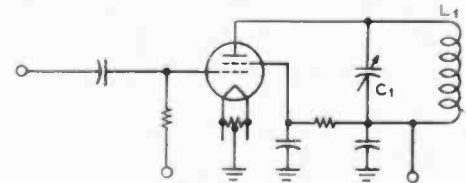

(B) SCREEN GRID AMPLIFIER

FIGURE 22

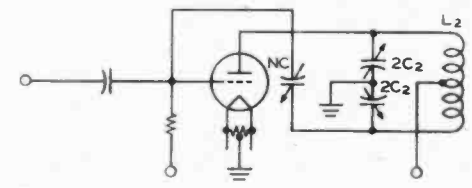

(A)

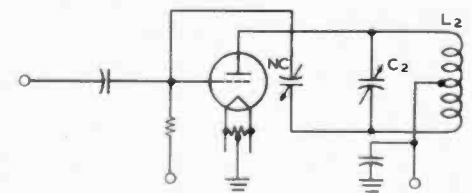

(B) PLATE NEUTRALIZED AMPLIFIERS

FIGURE 23

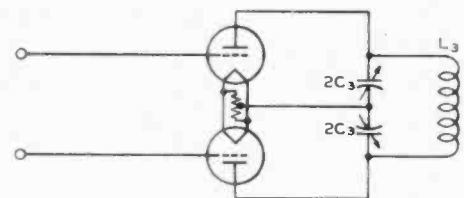

PUSH PULL AMPLIFIER

FIGURE 24

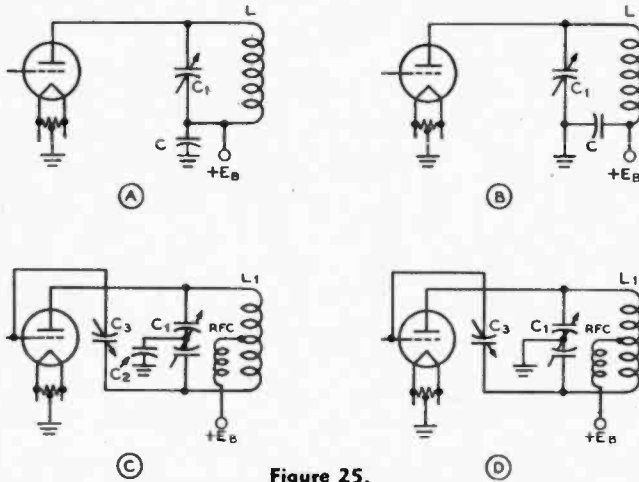

Figure 25. CLASS C AMPLIFIER PLATE CIRCUIT ARRANGEMENTS.

The tubes in the push-pull circuit of Figure 24 work on a portion of each half cycle, so less storage or flywheel effect is needed theoretically, and a value of $Q = 6$ may be used instead of $Q = 12$. However, for the sake of safety in insuring that harmonic radiation will be at a minimum, it is recommended that values of circuit Q of approximately 12 be used also in the case of push-pull amplifiers where harmonic radiation may cause interference to other services.

The values of R_p are easily calculated by dividing the d-c plate supply voltage by the total d-c plate current (expressed in amperes). Correct values of total tuning capacitance are shown in the charts for the different amateur bands. The shunt stray capacitance can be estimated closely enough for all practical purposes. The coil inductance should then be chosen which will produce resonance at the desired frequency with the total calculated tuning capacitance.

The capacitances shown are the minimum recommended values and they should be increased 50 per cent to 100 per cent for modulated Class C amplifiers where economically feasible. The values shown in the charts are sufficient for c-w operation of Class C amplifiers. It is again emphasized that these values are *total capacitances* across the tank circuit, and should not be considered as the capacitance *per section* for a *split-stator* capacitor. If a split-stator capacitor is to be used, the *per section* capacitance should be *twice* that indicated by the charts shown on page 115.

6-10 Tuning Capacitor Air Gap

Plate-Spacing Requirements for Various Circuits and Plate Voltages In determining capacitor air gaps, the peak r-f voltage impressed across the capacitor is the important item, since the experimental and practical curves of air gap versus peak volts may be applied to any capacitor with polished plates having rounded

edges. Typical peak breakdown voltages for corresponding air gaps are listed in the table. These values can be used in any circuit. The problem is to find the peak r-f voltage in each case; this can be done quite easily.

The instantaneous r-f voltage in the plate circuit of a Class C amplifier tube varies from nearly zero to nearly twice the d-c plate voltage. If the d-c voltage is being 100 per cent modulated by an audio voltage, the r-f peaks will reach nearly four times the d-c voltage. The circuits shown in Figures 25B and 25D require a tuning capacitor with plate spacing which will have an r-f peak breakdown rating at least equal to 2 times or 4 times the d-c plate voltage for c-w and plate-modulated amplifiers respectively.

It is possible to reduce the air gap to one-half by connecting the amplifier so that the d-c plate voltage does not appear across the tuning capacitor. This is done in Figures 25A and 25C. These circuits should always be used in preference to those of Figures 25B and 25D since the tuning capacitor is only about one-fourth as large physically for the same capacitance and is less expensive.

For a Class B linear, Class C grid-modulated, or c-w amplifier, the instantaneous voltage across the tube varies from nearly zero up to twice E_b . The r-f voltage is an a-c voltage varying from zero to a positive and then to a negative maximum over each cycle. The fixed (mica) capacitor C_1 in Figure 25A and C_2 in Figure 25C insulates the rotor from d.c. and allows us to subtract the d-c voltage value from the tube peak r-f voltage value in calculating the breakdown voltage to be expected.

These rules apply to a loaded amplifier or buffer stage. If either is operated without an r-f load, the peak voltages may be greater. For this reason no amplifier should be operated without load when anywhere near normal d-c plate voltage is applied.

A factor of safety in the air-gap rating should be applied to insure freedom from r-f flashover. This is especially true when using the circuits of 25B and 25D; in these circuits the plate supply is shorted when a flash-over occurs. Knowing the peak r-f voltage, an air gap should be chosen which will be about 100 per cent greater than the breakdown rating. The air gaps listed will break down at the approximate peak voltages in the table. If the circuits are of the form shown in 25B and 25D, the peak voltages across the capacitors will be nearly twice as high, and twice as large an air gap is needed. The fixed capacitors, usually of the mica type, shown in Figures 25A and 25C must be rated to withstand the d-c plate voltage plus any audio voltage. This capacitor should be rated at a d-c working voltage of at least *twice the d-c plate supply in a plate modulated amplifier*, and at least *equal to the d-c supply* in any other type of r-f amplifier. See also Figure 9D and accompanying text for further data on how to get the rotor to follow the modulated plate voltage.

Recommended Air gap (approx. 100% factor of safety) for the circuits of Figures 25A and 25C. Spacings should be multiplied by 1.5 for same factor of safety with circuits of Figures 25B and 25D.

D.C. PLATE VOLTAGE	C.W.	PLATE MOD.
400	.030	.050
600	.050	.070
750	.050	.084
1000	.070	.100
1250	.070	.144
1500	.078	.200
2000	.100	.250
2500	.175	.375
3000	.200	.500
3500	.250	.600

BREAKDOWN RATINGS OF COMMON PLATE SPACINGS	
AIR-GAP IN INCHES	PEAK VOLTAGE BREAKDOWN
.030	1000
.050	1500
.070	3000
.078	3500
.084	3800
.100	4150
.144	5000
.175	5700
.200	6200
.250	7200
.300	8200
.350	9250
.375	10,000
.500	12,000
.600	14,000

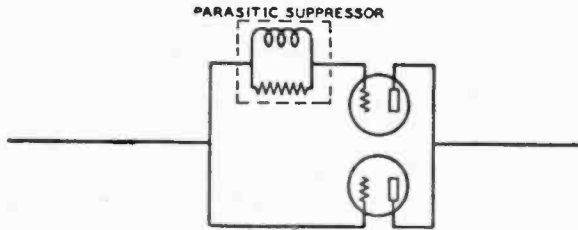

Figure 26.
PARASITIC SUPPRESSOR.

Showing the use of a parasitic suppressor in series with one grid of a pair of paralleled tubes. In a push-pull amplifier which develops parasitics, the parasitic suppressor can be connected in series with the lead from the grid tank circuit to the grid of one of the tubes.

Push-Pull Stages The circuits of Figures 25C and 25D apply without any change in calculations to push-pull amplifiers. Only one tube is supplying power to the tuned circuit at any given instant, each one driving a part of each half cycle. The different value of Q and increased power output increase the peak voltages slightly, but, for all practical purposes, the same calculation rules may be employed.

These rules apply to any form of r-f amplifier, with a recommended factor of safety of 100 per cent to prevent flashover in the capacitor. This is sufficient for operation into normal loads at all times, providing there are no parasitic oscillations present. The latter sometimes cause flashover across air gaps which should ordinarily stand several times the normal peak r-f voltages. This is especially true of low-frequency parasitics.

The actual peak voltage values of a stable, loaded r-f amplifier actually are a little less than the calculations indicate, which gives an additional factor of safety in the design.

6-11 Parasitic Oscillation in R-F Amplifiers

Parasitics (as distinguished from *self-oscillation* on the normal tuned frequency of the amplifier) are undesirable oscillations either of very high or very low frequencies which may occur in radio-frequency amplifiers.

They may cause spurious signals (which are often rough in tone) other than normal harmonics, hash on each side of a modulated carrier, key clicks, voltage breakdown or flashover, instability or inefficiency, and shortened life or failure of the tubes. They may be damped and stop by themselves after keying or on modulation cycles, or they may be undamped and build up during ordinary unmodulated transmission, continuing if the excitation is removed. They may result from series or parallel resonant circuits of all types. Due to the neutralizing lead length or the nature of most parasitic circuits, the amplifier usually is not neutralized for the parasitic frequency.

Sometimes the fact that the plate supply is keyed obscures parasitic oscillations that might be very severe if the plate voltage were left on and only the excitation removed.

In some cases, an all-wave receiver will prove helpful in finding out if the amplifier is without spurious oscillations, but it may be necessary to check from one meter on up, to be perfectly sure. A normal harmonic is weaker than the fundamental but of good tone; a strong harmonic or a rough note at any frequency generally indicates a parasitic.

Low-Frequency Parasitics One type of unwanted oscillation often occurs in shunt-fed circuits in which the grid and plate chokes resonate, coupled through the tube's inter-electrode capacitance. It also can happen with series feed. This oscillation is generally at a much lower frequency than the desired one and causes additional carriers to appear, spaced from perhaps twenty to a few hundred kilocycles on either side of the main wave. One cure is to

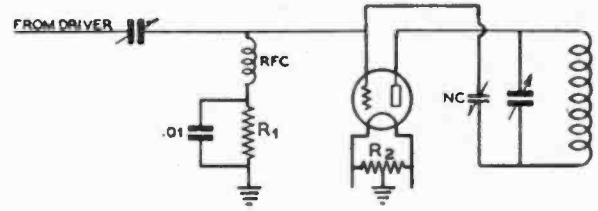

Figure 27.
GRID LEAK BIASED STAGE.

Showing how a resistor may be connected in series with the grid return lead to obtain bias due to the flow of rectified grid current through the resistor.

change the type of feed in either the grid or plate circuit or to eliminate one choke. Another is to use much less inductance in the grid choke than in the plate choke, or to replace the grid choke by a wire-wound resistor if the grid is series fed. In a Class C stage with grid-leak bias, no r-f choke is required if the bias is series fed.

This type of parasitic may take place in push-pull circuits, in which case the tubes are effectively in parallel for the parasitic and hence, the neutralization is not effective. The grids or plates can be connected together without affecting the undesired oscillation; this is a simple test for this type of parasitic.

Parallel Tubes A very-high-frequency inter-tube oscillation often occurs when tubes are operated in parallel. Non-inductive damping resistors or manufactured parasitic suppressors in the grid circuit, or short inter-connecting grid leads, together with small plate choke coils, will prove helpful.

Tapped Inductances When capacitance coupling is used between stages, particularly when one of the stages is tapped down from the end of the coil, additional parasitic circuits are formed because of the multiple resonant effects of this complex circuit. Inductive or link coupling permits making adjustments without forming these undesired circuits. A capacitor tapped across only part of an inductance, for bandspread tuning or capacitance loading, also can give rise to parasitics.

Multi-Element Tubes It might be thought that screen-grid, pentode, and beam-tetrode tubes would help to minimize parasitic circuits by requiring no neutralization, but their high gain usually aggravates parasitic oscillations. Furthermore, the bypass circuit from the additional elements to the filament must be short and effective, particularly at the higher frequencies, to prevent undesired internal coupling. At very high frequencies, a certain critical value of screen bypass capacitor may improve the internal shielding without causing a new parasitic oscillation. The capacitance should be such as to series resonate the screen lead inductance at the operating frequency of the amplifier. A blocking (relaxation) effect may occur if the screen is fed through a series resistor. Also, the screen circuit can act as the plate in a tuned-grid tuned-plate oscillation that can be detuned or damped at the control grid terminal.

Crystal Stages Crystal oscillators are seldom suspected of parasitic oscillation troubles, but are often guilty. The same remedial measures as recommended for amplifiers should be employed.

Parasitic Suppressors The most common type of parasitic is of the u.h.f. type, which fortunately can usually be damped by inserting a parasitic suppressor of

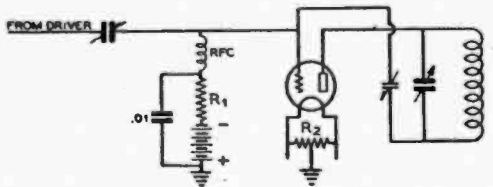

Figure 28.

COMBINATION GRID LEAK AND BATTERY BIAS.

A battery may be added to the arrangement of Figure 27 to provide protection in case of excitation failure.

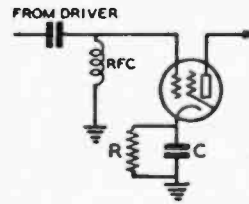

Figure 29.

CATHODE OR "AUTOMATIC" BIAS.

Figure 30.

BATTERY BIAS.

the type illustrated in Figure 26 in the grid lead, or in *one* grid lead of either a push-pull or parallel tube amplifier.

Chasing Parasitics The preceding paragraphs give a short introduction to the subject of parasitic oscillations. However, in order to insure that an amplifier is operating in a perfectly stable manner without any tendency toward parasitics, and also to eliminate any parasitics should they occur, it is wise to follow an orderly and set procedure. Such a procedure is discussed in detail in Chapter 10, *Transmitter Adjustment*.

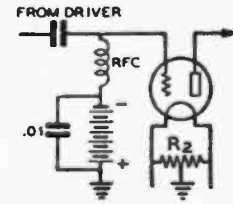
6-12 Grid Bias

Radio-frequency amplifiers require some form of *grid bias* for proper operation. Practically all r-f amplifiers operate in such a manner that plate current flows in the form of short, peaked impulses which have a duration of only a fraction of an r-f cycle. To accomplish this, the grid bias is at least sufficient to cut off the plate current, and in very high efficiency Class C amplifiers this bias may be many times the cutoff value. Cutoff bias, it will be recalled, is that value of grid voltage which will reduce the plate current to zero at the plate voltage employed. The method for calculating it has been indicated previously. This theoretical value of cutoff will not reduce the plate current completely to zero, due to the variable- μ tendency or "knee" which is characteristic of all tubes as the cutoff point is approached. This factor, however, is of no importance in practical applications.

Class C Bias Radiophone Class C amplifiers should be operated with the grid bias adjusted to values between two and three times cutoff at normal values of d-c grid current, to permit linear operation (necessary when the stage is plate-modulated). C-w telegraph transmitters can be operated with bias as low as cutoff, if only limited excitation is available and moderate plate efficiency is satisfactory. In a c-w transmitter, the bias supply or resistor should be adjusted to the point which will allow normal grid current to flow for the particular amount of grid driving r-f power available. This form of adjustment will allow more output from the under-excited r-f amplifier than when higher bias is used with corresponding lower values of grid current.

Grid-Leak Bias A resistor can be connected in the grid circuit of an r-f amplifier to provide grid-leak bias. This resistor, R_1 in Figure 27, is part of the d-c path in the grid circuit.

The r-f excitation applied to the grid circuit of the tube causes a pulsating direct current to flow through the bias supply lead, due to the rectifying action of the grid, and any current flowing through R_1 produces a voltage drop across that resistor. The grid of the tube is positive for a short duration of each r-f cycle, and draws electrons from the filament or cathode of the tube during that time. These electrons complete the circuit through the d-c *grid return*.

The voltage drop across the resistance in the grid return provides a *negative bias* for the grid. The r-f chokes in Figures 27, 28, 29 and 30 prevent the r-f excitation from flowing through the bias supply, or from being short-circuited to ground. The bypass capacitor across the bias source proper is for the purpose of providing a low impedance path for the small amount of stray r-f energy which passes through the r-f choke.

Grid-leak bias automatically adjusts itself over fairly wide variations of r-f excitation. The value of grid-leak resistance should be such that normal values of grid current will flow at the maximum available amount of r-f excitation. Grid-leak bias cannot be used for grid-modulated or linear amplifiers in which the average d-c grid current is constantly varying with modulation.

Safety Bias Grid-leak bias alone provides no protection against excessive plate current in case of failure of the source of r-f grid excitation. A *C-battery* or *C-bias* supply can be connected in series with the grid lead, as shown in Figure 28. This fixed "protective" bias will protect the tube in the event of failure of grid excitation. "Zero-bias" tubes do not require this bias source in addition to the grid leak, since their plate current will drop to a safe value when the excitation is removed.

Cathode Bias A resistor can be connected in series with the cathode or center-tapped filament lead of an amplifier to secure *automatic bias*. The plate current flows through this resistor, then back to the cathode or filament, and the voltage drop across the resistor can be applied to the grid circuit by connecting the grid bias lead to the grounded or power supply end of the resistor R , as shown in Figure 29.

The grounded (B-minus) end of the cathode resistor is negative relative to the filament by an amount equal to the voltage drop across the resistor. The value of resistance must be so chosen that the sum of the desired grid and plate current flowing through the resistor will bias the tube for proper operation.

This type of bias is used more extensively in audio-frequency than in radio-frequency amplifiers. The voltage drop across the resistor must be subtracted from the total plate supply voltage when calculating the power input to the amplifier, and this loss of plate voltage in an r-f amplifier may be excessive. A Class A audio amplifier is biased only to approximately one-half cutoff, whereas an r-f amplifier may be biased to twice cutoff, or more, and thus the plate supply voltage loss may be a large percentage of the total available voltage when using low- or medium- μ tubes.

Oftentimes just enough cathode bias is employed in an r-f amplifier to act as safety bias to protect the tubes in case of excitation failure, with the rest of the bias coming from a grid leak.

Separate Bias Supply A "C" battery or an external C-bias supply, sometimes is used for grid bias, as shown in Figure 30.

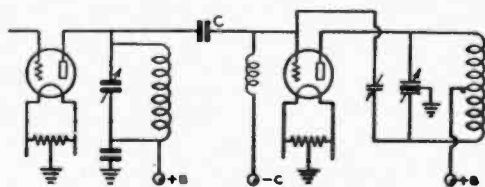

Figure 31.

CAPACITIVE INTERSTAGE COUPLING

This is the simplest form of interstage coupling.

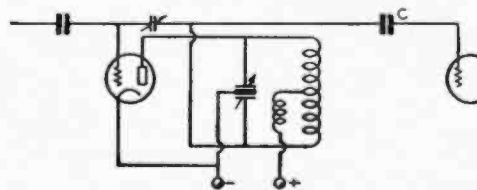

Figure 32.

BALANCED CAPACITIVE COUPLING.

This type of capacitive interstage coupling helps to equalize the capacities across the two sides of the driver tank circuit.

Battery bias gives very good voltage regulation and is satisfactory for grid-modulated or linear amplifiers, which operate at low grid current. In the case of Class C amplifiers which operate with high grid current, battery bias is not very satisfactory. This direct current has a charging effect on the dry batteries; after a few months of service the cells will become unstable, bloated, and noisy.

A separate a-c operated power supply can be used as a substitute for dry batteries. The bleeder resistance across the output of the filter can be made sufficiently low in value that the grid current of the amplifier will not appreciably change the amount of negative grid-bias voltage. Alternately, a voltage regulated grid-bias supply as described in Chapter 25 and illustrated in several of the equipments shown in Chapter 26 can be used. This type of bias supply is used in Class B audio and Class B r-f linear amplifier service where the voltage regulation in the C-bias supply is important. For a Class C amplifier, regulation is not so important, and an economical design of components in the power supply, therefore, can be utilized. In this case, the bias voltage must be adjusted with normal grid current flowing, as the grid current will raise the bias considerably when it is flowing through the bias-supply bleeder resistance.

6-13 Interstage Coupling

Energy is usually coupled from one circuit of a transmitter into another either by *capacitive coupling*, *inductive coupling*, or *link coupling*. The latter is a special form of inductive coupling. The choice of a coupling method depends upon the purpose for which it is used.

Capacitive Coupling Capacitive coupling between an amplifier or doubler circuit and a preceding driver stage is shown in Figure 31.

The coupling capacitor, C, isolates the d-c plate supply from the next grid and provides a low impedance path for the r-f energy between the tube being driven and the driver tube. This method of coupling is simple and economical for low-power amplifier or exciter stages, but has certain disadvantages, particularly for high frequency stages. The grid leads in an amplifier should be as short as possible, but this is difficult to attain in the physical arrangement of a high-power amplifier with respect to a capacitively-coupled driver stage.

Disadvantages of Capacitive Coupling The r-f choke in series with the C-bias supply lead must offer an extremely high impedance to the r-f circuit, and this is difficult to obtain when the transmitter is operated on several harmonically related bands. Another disadvantage of capacitive coupling is the difficulty of adjusting the load on the driver stage. Impedance adjustment can be accomplished by tapping the coupling lead a part of the way down on the plate coil of the tuned stage of the driver circuit, but often when this is done a parasitic oscillation tendency becomes very troublesome and is difficult to eliminate.

Capacitive coupling places the grid-to-filament capacitance of the driven tube directly across the driver tuned circuit, which sometimes makes the r-f amplifier difficult to neutralize because the additional driver stage circuit capacitances are connected into the grid circuit. Difficulties from this source can be partially eliminated by using a center-tapped or split-stator tank circuit in the plate of the driver stage, and coupling capacitively to the opposite end from the plate. This method places the plate-to-filament capacitance of the driver across one-half of the tank and the grid-to-filament capacitance of the following stage across the other half. This type of coupling is shown in Figure 32.

Capacitive coupling can be used to advantage in reducing the total number of tuned circuits in a transmitter so as to conserve space and cost. It also can be used to advantage between stages for driving beam tetrode or pentode amplifier or doubler stages. These tubes require relatively small amounts of grid excitation, and a reduction in driving efficiency is not so important.

Inductive Coupling *Inductive coupling* (Figure 33) consists of two coils electromagnetically coupled to each other. The degree of coupling is controlled by varying the mutual inductance of the two coils, which is accomplished by changing the spacing between the coils.

Inductive coupling is used extensively for coupling r-f amplifiers in radio receivers. However, the mechanical problems involved in adjusting the degree of coupling as is usually required in a transmitter limit its usefulness in transmitters. Either the primary or the secondary or both coils may be tuned.

Unity Coupling If the grid tuning capacitor of Figure 33 is removed and the coupling increased to the maximum practicable value by interwinding the turns of the two coils, the circuit in so far as r-f is concerned acts like that of Figure 31, in which one tank serves both as plate tank for the driver and grid tank for the driven stage. The interwound grid winding serves simply to isolate the d-c plate voltage of the driver from the grid of the driven stage, and to provide a return for d-c grid current. This type of coupling, illustrated in Figure 34, is commonly known as "unity coupling"

Because of the high mutual inductance, both primary and secondary are resonated by the one tuning capacitor.

Link Coupling A special form of inductive coupling which is widely employed in radio transmitter circuits is known as *link coupling*. A low impedance r-f transmission line couples the two tuned circuits together. Each end of the line is terminated in one or more turns of wire, or *loops*, wound around the coils which are being coupled together. These loops should be coupled to each tuned circuit at the point of zero r-f potential, or *nodal point*. A ground connection to one side of the link is used in special cases where harmonic elimination is important, or where capacitive coupling between two circuits must be minimized.

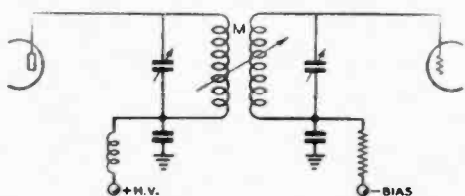

Figure 33.
INDUCTIVE INTERSTAGE COUPLING.

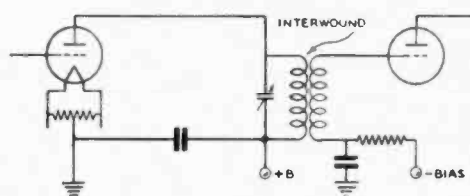

Figure 34.
"UNITY" INDUCTIVE COUPLING.
Because of the high mutual inductance, the one tuning capacitor resonates both circuits.

Typical link coupled circuits are shown in Figures 35 and 36. Some of the advantages of link coupling are the following:

- (1) It eliminates coupling taps on tuned circuits.
- (2) It permits the use of series power supply connections in both tuned grid and tuned plate circuits, and thereby eliminates the need of r-f chokes.
- (3) It allows separation between transmitter stages without appreciable r-f losses or stray chassis currents.
- (4) It reduces capacitive coupling and thereby makes neutralization more easily attainable in r-f amplifiers.
- (5) It provides semi-automatic impedance matching between plate and grid tuned circuits, with the result that greater grid drive can be obtained in comparison to capacitive coupling.
- (6) It effectively reduces spurious radiations.

The link-coupling line and loops can be made of no. 18 push-back wire for coupling between low-power stages. For coupling between higher powered stages the 150-ohm twin-lead transmission line is quite effective and has very low loss. Either the 300-ohm or 75-ohm line can also be used if the 150-ohm type is not available, but the 150-ohm line is the most convenient mechanically and electrically for most applications. Coaxial transmission line or open-wire lines can also be used between high-powered amplifier stages.

6-14 Radio-Frequency Chokes

Radio-frequency chokes are connected in circuits for the purpose of preventing r-f energy from being short-circuited or escaping into power supply circuits. They consist of inductances wound with a large number of turns, either in the form of a solenoid, a series of solenoids, a single universal pie winding, or a series of pie windings. These inductors are designed to have as much inductance and as little distributed or shunt capacitance as possible. The unavoidable small amount of distributed capacitance resonates the inductance, and this frequency normally should be much lower than the frequency at which the transmitter or receiver circuit is operating. R-f chokes for operation on several bands must be designed carefully so that the impedance of the choke will be extremely high (several hundred thousand ohms) in each of the bands.

The direct current which flows through the r-f choke largely

determines the size of wire to be used in the winding. The inductance of r-f chokes for very short wave-lengths is much less than for chokes designed for broadcast and ordinary short-wave operation. A very high inductance r-f choke has more distributed capacitance than a smaller one, with the result that it will actually offer *less* impedance at very high frequencies.

Another consideration, just as important as the amount of d.c. the winding will carry, is the r-f voltage which may be placed across the choke without its breaking down. This is a function of insulation, turn spacing, frequency, number and spacing of pies and other factors.

Some chokes which are designed to have a high impedance over a very wide range of frequency are, in effect, really two chokes; a u-h-f choke in series with a high-frequency choke. A choke of this type is polarized; that is, it is important that the correct end of the combination choke be connected to the "hot" side of the circuit.

Shunt and Series Feed Direct-current grid and plate connections are made either by *series* or *parallel feed* systems. Simplified forms of each are shown in Figures 37 and 38.

Series feed can be defined as that in which the d-c connection is made to the grid or plate circuits at a point of very low r-f potential. Shunt feed always is made to a point of high r-f voltage and always requires a high impedance r-f choke or resistance to prevent waste of r-f power.

6-15 Parallel and Push-Pull Tube Circuits

The comparative r-f power output from parallel or push-pull operated amplifiers is the same if proper impedance matching is accomplished, if sufficient grid excitation is available in both cases, and if the frequency of measurement is considerably lower than the frequency limit of the tubes.

Parallel Operation Operating tubes in parallel has some advantages in transmitters designed for operation below 10 Mc. Only one neutralizing capacitor is required for parallel operation, as against two for push-pull. Above about 10 Mc., depending upon the tube type, parallel tube operation is ordinarily not recommended with triode

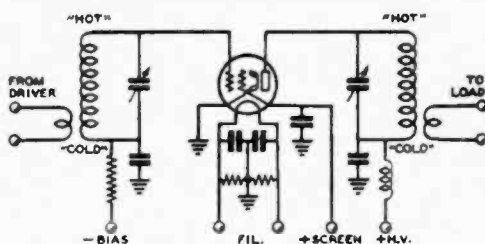

Figure 35.
LINK COUPLED CIRCUIT.
Showing link coupling into and out of a single-ended beam-tetrode amplifier stage. The coupling links should be placed at the "cold" or low-potential ends of the grid and plate coils.

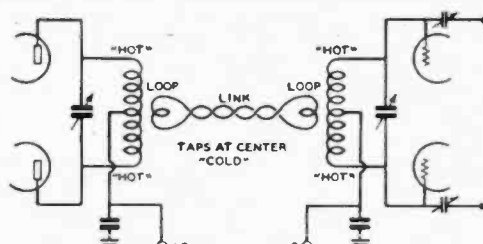

Figure 36.
PUSH-PULL LINK COUPLING.
When link coupling is used between push-pull stages or between "split" tank circuits, the coupling loops are placed at the center of the coils.

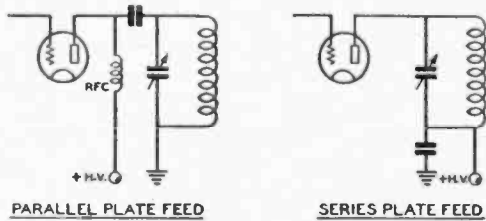

Figure 37.

ILLUSTRATING PARALLEL AND SERIES PLATE FEED.

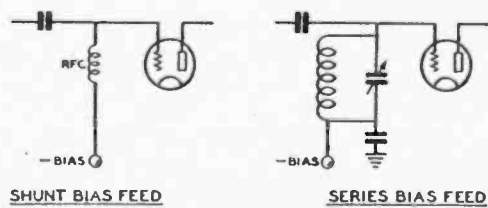

Figure 38.

ILLUSTRATING SHUNT AND SERIES BIAS FEED.

tubes. However, grounded-grid amplifiers and stages using low-C beam-tetrodes can often be used with excellent results well into the v-h-f range.

Push-Pull Operation The push-pull connection provides a well-balanced circuit insofar as miscellaneous capacitances are concerned; in addition, the circuit can be neutralized more completely, especially in high-frequency amplifiers. The L/C ratio in a push-pull amplifier can be made higher than in a plate-neutralized parallel-tube operated amplifier. Push-pull amplifiers, when perfectly balanced, have less second-harmonic output than parallel or single-tube amplifiers, but in practice undesired capacitive coupling and circuit unbalance partly offset the theoretical harmonic-reducing advantages of push-pull r-f circuits.

6-16 Special Considerations in U-H-F and V-H-F Transmitters

In the v-h-f and u-h-f range, simple but well constructed stabilized oscillators are satisfactory for c.w. Such an oscillator can also be used for AM phone on the 144-148 Mc. band and above. Coaxial-line stabilized oscillator circuits are illustrated in Figures 39 and 41, and parallel-rod line-stabilized oscillator circuits are illustrated in Figures 40 and 43.

Line-Controlled Oscillators In oscillators, it is highly important to have a lightly loaded, high-Q circuit to control the frequency. Such circuits can substantially reduce hum, drift, and frequency modulation. Partial neutralization is a help. A concentric line (when not used with

a poor loading capacitor) with loose coupling to the grid of the oscillator tube will turn out a good job in a single-ended or push-pull circuit. More commonly, parallel rods are used in push-pull circuits, particularly in plate circuits; if they have a large diameter, remarkably good stability can be obtained.

Due to the appreciable length of cathode leads in terms of wavelength at ultra-high frequencies, push-pull transmitters sometimes become inoperative or unusually inefficient as the frequency is raised. A section of small-size transmission line electrically a half wavelength long can be used to interconnect filaments and place them at ground potential, as indicated by Figure 42. The shorting bar can be moved to the position where output is greatest or, in some cases, to the only place where oscillation will occur. This application of resonant lines should not be confused with the tuned-plate-tuned-grid circuit in which the grid line is moved around to the filament and adjusted to provide the reactance common to grid and plate circuits necessary to maintain oscillation.

Neutralizing capacitors are often used on u-h-f oscillators, being adjusted on either side of true neutralization, in order to control the amount of feedback and to reduce the effect of tube and plate circuit variations upon the frequency-controlling grid circuit.

Two-band operation in oscillators using parallel rods can be arranged conveniently by shorting the open end of the grid control line with a second shorting bar, and readjusting the plate circuit. The resulting half wavelength grid line is loaded by the tube input capacitance, making it desirable to slide the grid taps down farther, and requiring a very much shortened line. For instance, a quarter wavelength grid line on 145 Mc.

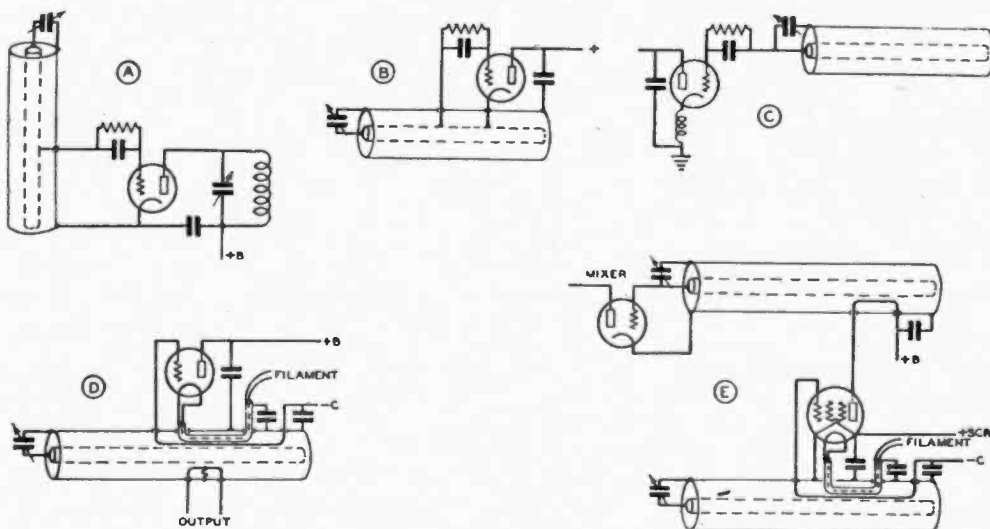

Figure 39.

TYPICAL COAXIAL LINE CONTROLLED OSCILLATOR CIRCUITS.

(A) Concentric-line-tuned grid, coil-tuned-plate oscillator. (B) Cathode-above-ground type oscillator circuit with concentric line. (C) Single control oscillator circuit without tap on line, although stability can be increased by tapping the grid down. (D) RCA's oscillator circuit used in a broad band transmitter having good stability, requiring only one tuned circuit. (E) Similar to (D) but showing pentode tube and balanced loop coupling to mixer stage. All coaxial tanks are shorted at the end opposite the tuning capacitor.



Figure 40.

SIMPLIFIED SCHEMATIC OF SINGLE TUBE OSCILLATOR USING RESONANT LINE WITH PARALLEL CONDUCTORS.

Tubes with an amplification factor of more than 10 are not well suited for use in this circuit. The blocking capacitor serves as a shorting bar when frequency adjustment is required. The amount of feedback can be controlled over certain limits by varying the bias resistor or bias voltage.

may be 15 or more inches long, whereas a loaded half wavelength line on 235 Mc. may turn out to be only 9 inches, making it necessary to slide the upper or second shorting bar down from the former open end of the line.

Electron-Orbit Oscillator The range of oscillation in ordinary circuits is limited by the time required for electrons to travel from cathode to anode. This transit time is negligible at low frequencies, but becomes an important factor above 100 Mc. With ordinary tubes, oscillation can be secured above the normal upper frequency limit by means of *electron-orbit oscillators*, in which the grid is made positive and the plate is kept at zero or slightly negative potential. Oscillation can often be obtained on frequencies well above 500 Mc.

Klystrons and Magnetrons Although acorn-tube 6F4 can be used as an oscillator in properly designed linear-tank circuits up to about 1200 Mc. and the "light-house" type of tube can be used as an oscillator in appropriate circuits up to about 3500 Mc., it is more common to use magnetrons as high-power oscillators and klystrons as low-power oscillators in the frequency range above approximately 700 Mc. The operation of klystron and magnetron tubes has been described in Chapter 3.

U-H-F Amplifiers Master oscillators can be built to drive modulated amplifiers with adequate frequency stability in the u-h-f range. Where highly stable transmission is desired, however, the tendency in design is to use a crystal or electron-coupled oscillator at a lower frequency, followed by frequency multipliers. This arrangement provides

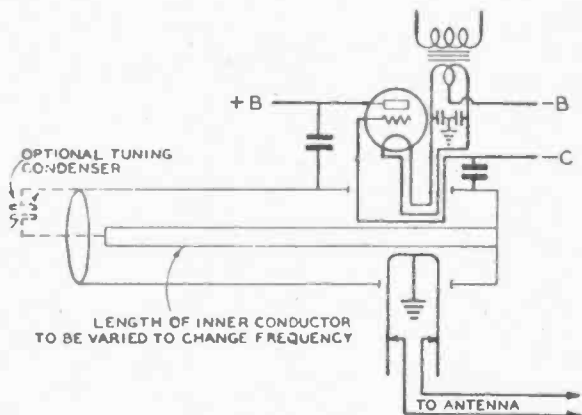

Figure 41.

COAXIAL PIPE OSCILLATOR USING SINGLE TANK CIRCUIT.

The frequency can be varied either by the optional tuning capacitor shown or by varying the length of the inner conductor of the concentric line.

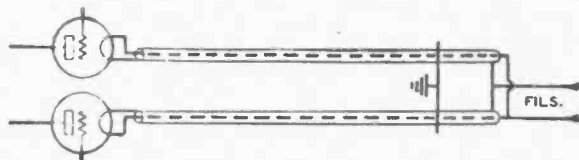

Figure 42.

Arrangement for using shortened 1/2-wave line in filament circuit to put both filaments at exact ground potential.

good stability under modulation, but may drift in frequency more with heating than will a well designed transmission-line-controlled u-h-f oscillator.

Single-ended oscillator and amplifier stages are often used, but there is reason to prefer push-pull circuits in order to reduce tube capacitance across resonant circuits, to obtain balanced arrangements, and to reduce the importance of the cathode leads.

The driving power required by an amplifier tube can be high if there are leads of any appreciable length from the grid or plate to any tuning capacitor other than one used as a shorting bar on a pair of rods, or if the capacitor has a long inductive path through its frame. The returns from these circuits to the cathode are important, especially in single-ended stages. Lead inductance can be reduced by using copper ribbon or tubing for connections, instead of smaller wire.

Frequency doublers have been used to 240 Mc. Push-pull triplers, especially when some regeneration is permitted by using a dual frequency grid circuit or a tuned cathode circuit, are highly satisfactory even above 300 Mc. when suitable tubes are used.

Both in receivers and transmitters, regeneration or oscillation often results from the use of cathode bias, not adequately by-passed for u.h.f. Ordinary by-pass capacitors have considerable inductance in them which combined with their capacitance may place a sizable reactance in common with the grid and plate returns. Small silvered mica capacitors have sometimes proved better than units of average size and higher capacitance. Special u-h-f sockets with built-in by-pass capacitors can be used to advantage above 200 Mc.

The 829-B and 832-A push-pull transmitting beam power types will give full rated c-w output as amplifiers at 200 Mc. Type 815 will give 90% of normal output at 145 Mc., the 2E26 will give 83% of normal output at this frequency, and the 4-125A/4D21 beam tetrode will give about 60% of normal output at 240 Mc. Type 826 transmitting triode will give 80% of normal rated output at 300 Mc., while type 8012 u-h-f transmitting triode will give full output at 500 Mc.

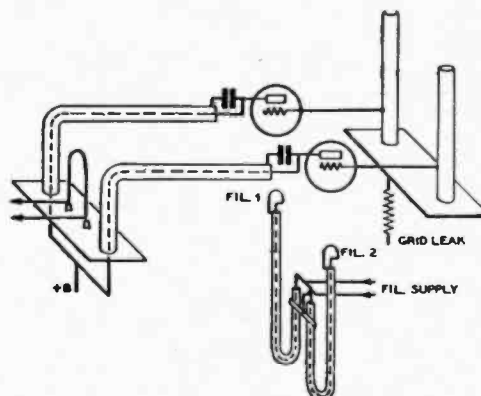

Figure 43.

Practical physical layout for push-pull oscillator using resonant lines in filament, grid, and plate circuits.

Amplitude Modulation and Keying

IF THE output of a good radiotelegraph transmitter is by some means varied in amplitude* at an audio frequency rate instead of interrupted in accordance with code characters, a tone will be heard on a receiver tuned to the signal. If the audio tone is replaced with a band of audio frequencies comprising voice or music intelligence, then the voice or music which is superimposed on the radio frequency carrier will be heard on the receiver.

When voice, music, video, or other intelligence is superimposed on a radio frequency carrier by means of a corresponding variation in the amplitude of the radio frequency output of a transmitter, *amplitude modulation* is the result. C-w keying of a telegraph transmitter is the simplest form of amplitude modulation, while video modulation in a television transmitter represents a highly complex form. Systems for modulating the amplitude of a carrier envelope in accordance with voice, music, or similar types of complicated waveforms are many and varied, and will be discussed later on in this chapter.

Sidebands Modulation is essentially a form of *mixing*, already covered in a previous chapter. To transmit voice at radio frequencies by means of amplitude modulation, the voice frequencies are mixed with a radio frequency carrier so that the voice frequencies are converted to radio frequency *side-bands*. Though it may be difficult to visualize, *the amplitude of the radio frequency carrier does not vary during modulation*.

Even though the amplitude of radio frequency voltage representing the composite signal (resultant of the carrier and sidebands, called the "envelope") will vary from zero to twice the unmodulated signal value during full modulation, the amplitude of the *carrier* component does not vary. Also, so long as the amplitude of the modulating voltage does not vary, the

amplitude of the sidebands will remain constant. For this to be apparent, however, it is necessary to measure the amplitude of each component with a highly selective filter. Otherwise, the measured power or voltage will be a *resultant* of two or more of the components, and the amplitude of the resultant will vary at an audio rate.

If a carrier frequency of 5000 kc. is modulated by a pure tone of 1000 cycles, or 1 kc., two sidebands are formed: one at 5001 kc. (the sum frequency) and one at 4999 kc. (the difference frequency). The frequency of each sideband is independent of the amplitude of the modulating tone, or *modulation percentage*; the frequency of each sideband is determined only by the frequency of the modulating tone. This assumes, of course, that the transmitter is not modulated in excess of its capability.

When the modulating signal consists of multiple frequencies, as is the case with voice or music modulation, two sidebands will be formed by each modulating frequency (one on each side of the carrier), and the radiated signal will consist of a *band* of frequencies. The *band width*, or space taken up in the frequency spectrum by an amplitude modulated signal, is equal to twice the highest modulating frequency. For example, if the highest modulating frequency is 5000 cycles, then the signal (assuming modulation of complex and varying waveform) will occupy a band extending from 5000 cycles below the carrier to 5000 cycles above the carrier.

Frequencies up to at least 2500 cycles, and preferably 3500 cycles, are necessary for good speech intelligibility. If a filter is incorporated in the audio system to cut out all frequencies above approximately 3000 cycles, the band width of a radiotelephone signal can be limited to 6 kc. without a significant loss in intelligibility. However, if harmonic distortion is introduced subsequent to the filter, as would happen in the case of an overloaded modulator or overmodulation of the carrier, new frequencies will be generated and the signal will occupy a band wider than 6 kc.

*Because of its increasing use and importance, a separate chapter has been devoted to frequency modulation. It is felt, however, that a thorough understanding of amplitude modulation is a prerequisite; therefore this chapter should be studied before proceeding to FM.

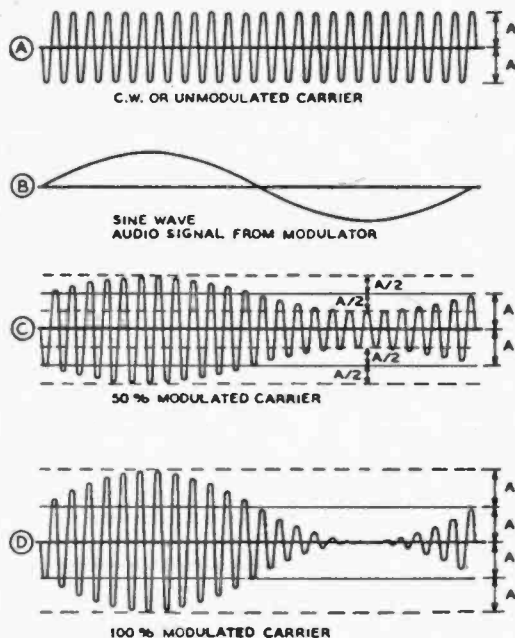

Figure 1.
MODULATION OF A CARRIER WAVE.

The top drawing (A) represents a continuous carrier wave; (B) shows the audio signal output from the modulator. (C) shows the audio signal impressed upon the carrier to the extent of 50 per cent modulation, and (D) shows the carrier with 100 per cent modulation. These drawings illustrate the mechanics of amplitude modulation.

Mechanics of Modulation A c-w or unmodulated r-f carrier wave is represented in Figure 1A. An audio frequency sine wave is represented by the curve of Figure 1B. When the two are combined or "mixed," the carrier is said to be amplitude modulated, and a resultant similar to 1C or 1D is obtained. It should be noted that under modulation, each half cycle of r-f voltage differs slightly from the preceding one and the following one; therefore at no time during modulation is the r-f waveform a pure sine wave. This is simply another way of saying that during modulation, the transmitted r-f energy no longer is confined to a single radio frequency.

It will be noted that the *average* amplitude of the peak r-f voltage, or modulation envelope, is the same with or without modulation. This simply means that the modulation is symmetrical, assuming a symmetrical (sine) modulating wave, and that for distortionless modulation the upward modulation is limited to a value of twice the unmodulated carrier wave amplitude because the amplitude cannot go below zero on downward portions of the modulation cycle. Figure 1D illustrates the maximum obtainable distortionless modulation with a sine modulating wave, the r-f voltage at the peak of the r-f cycle varying from zero to twice the unmodulated value, and the r-f power varying from zero to four times the unmodulated value (because the power varies as the square of the voltage).

While the average r-f *voltage* of the modulated wave over a modulation cycle is the same as for the unmodulated carrier, the average *power* increases with modulation. If the radio frequency power is integrated over the audio cycle, it will be found that with 100 per cent sine wave modulation the average r-f power has increased 50 per cent. This additional power is represented by the sidebands, because as previously mentioned, the carrier power does not vary under modulation. Thus, when a 100-watt carrier is modulated 100 per cent by a sine wave, the total r-f power is 150 watts; 100 watts in the carrier and 25 watts in each of the two sidebands.

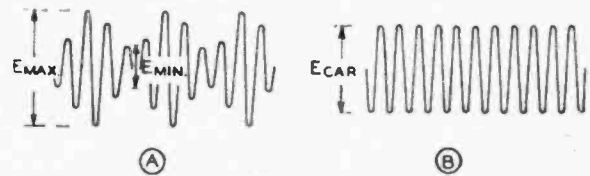

Figure 2.
GRAPHICAL REPRESENTATION OF MODULATED AND UNMODULATED CARRIER.

The method of determining the percentage modulation from the voltage points indicated is described in the text.

Modulation Percentage So long as the *relative proportion* of the various sidebands making up voice modulation is maintained, the signal may be received and detected without distortion. However, the higher the average amplitude of the sidebands, the greater the audio signal produced at the receiver. For this reason it is desirable to increase the *modulation percentage*, or degree of modulation, to the point where maximum peaks just hit 100 per cent. If the modulation percentage is increased so that the peaks exceed this value, distortion is introduced, and if carried very far, bad interference to signals on nearby channels will result.

Modulation Measurement The amount by which a carrier is being modulated may be expressed either as a modulation factor, varying from zero to 1.0 at maximum modulation, or as a percentage. The percentage of modulation is equal to 100 times the modulation factor. Figure 2A shows a carrier wave modulated by a sine-wave audio tone. A picture such as this might be seen on the screen of a cathode-ray oscilloscope with saw-tooth sweep on the horizontal plates and the modulated carrier impressed on the vertical plates. The same carrier without modulation would appear on the oscilloscope screen as Figure 2B.

The percentage of modulation of the positive peaks and the percentage of modulation of the negative peaks can be determined from two oscilloscope pictures such as shown.

The modulation factor of the positive peaks may be determined by the formula:

$$M = \frac{E_{\max} - E_{\text{car}}}{E_{\text{car}}}$$

The factor for negative peaks may be determined from this formula:

$$M = - \frac{E_{\min} - E_{\text{car}}}{E_{\text{car}}}$$

In the two above formulas E_{\max} is the maximum carrier amplitude with modulation and E_{\min} is the minimum amplitude; E_{car} is the steady-state amplitude of the carrier without modulation. Since the deflection of the spot on a cathode-ray tube is linear with respect to voltage, the relative voltages of these various amplitudes may be determined by measuring the deflections, as viewed on the screen, with a rule calibrated in inches or centimeters. The percentage of modulation of the carrier may be had by multiplying the modulation factor thus obtained by 100.

If the modulating voltage is symmetrical, such as a sine wave, and modulation is accomplished without the introduction of distortion, then the percentage modulation will be the same for both negative and positive peaks. However, the distribution and phase relationships of harmonics in voice and music waveforms are such that the percentage modulation of the negative modulation peaks may exceed the percentage modulation of the positive peaks, and vice versa. The percentage modulation when referred to without regard to polarity is an indication of the average of the negative and positive peaks.

Modulation Capability The modulation capability of a transmitter is the maximum percentage to which that transmitter may be modulated before spurious sidebands are generated in the output or before the distortion of the modulating waveform becomes objectionable. The highest modulation capability which any transmitter may have on the negative peaks is 100 per cent. The maximum permissible modulation of many transmitters is less than 100 per cent, especially on positive peaks. The modulation capability of a transmitter may be limited by flat tubes with insufficient filament emission, by insufficient excitation or grid bias to a plate-modulated stage, too light loading of any type of amplifier carrying modulated r.f., insufficient power output capability in the modulator, or too much excitation to a grid-modulated stage or a Class B linear amplifier. In any case, the FCC regulations specify that no transmitter be modulated in excess of its modulation capability. Hence, it is desirable to make the modulation capability of a transmitter as near as possible to 100 per cent so that the carrier power may be used most effectively.

Speech Waveform Dissymmetry The manner in which the human voice is produced by the vocal cords gives rise to a certain dissymmetry in the waveform of voice sounds when they are picked up by a good-quality microphone. This is especially pronounced in the male voice, and more so on certain voiced sounds than on others. The result of this dissymmetry in the waveform is that the voltage peaks on one side of the average value of the wave will be considerably greater, often two or three times as great, as the voltage excursions on the other side of the zero axis. The average value of *energy* on both sides of the wave is, of course, the same.

The net result of this dissymmetry in the male voice waveform is an optimum polarity of the modulating voltage that must be observed if maximum sideband energy is to be obtained without distortion or generation of "splatter" on adjacent channels.

A double-pole double-throw "phase reversing" switch in the input or output leads of any transformer in the speech amplifier system will permit poling the extended peaks in the direction of maximum modulation capability. The optimum polarity may be determined easily by listening on a selective receiver tuned to a frequency 30 to 50 kc. removed from the desired signal and adjusting the phase reversing switch to the position which gives the least "splatter" when the transmitter is modulated rather heavily. If desired, the switch then may be replaced with wiring.

A more conclusive illustration of the lopsidedness of a speech waveform may be obtained by observing the modulated waveform of a radiotelephone transmitter on an oscilloscope. A portion of the carrier energy of the transmitter should be coupled by means of a link directly to the vertical plates of the 'scope, and the horizontal sweep should be a sawtooth or similar wave (see the simple 3-inch oscilloscope described in Chapter 31) occurring at a rate of approximately 30 to 70 sweeps per second.

With the speech signal from the speech amplifier connected to the transmitter in one polarity it will be noticed that negative-peak clipping—as indicated by bright "spots" in the center of the 'scope pattern whenever the carrier amplitude goes to zero—will occur at a considerably lower level of average modulation than with the speech signal being fed to the transmitter in the other polarity. When the input signal to the transmitter is polarized in such a manner that the "fingers" of the speech wave extend in the direction of positive modulation these fingers will be clipped either in the modulator or in the driver for the modulator tubes.

The use of the proper polarity of the incoming speech wave in modulating a transmitter can afford an increase of approximately two to one in the amount of speech audio power which may be placed upon the carrier of an amplitude-modulated transmitter for the same amount of sideband splatter. Much more effective methods for the increasing of the amount of audio power on the carrier of an AM 'phone transmitter are discussed in Section 7-4 at the end of this Chapter.

Single-Sideband Transmission Because all of the intelligibility is contained in the sidebands on one side of the carrier, it is not necessary to transmit sidebands on both sides of the carrier. Also, because the carrier is simply a single radio frequency wave of unvarying amplitude, it is not necessary to transmit the carrier if some means is provided for inserting a locally generated carrier at the receiver.

When the carrier is suppressed but both upper and lower sidebands are transmitted, it is necessary to insert a locally generated carrier at the receiver of *exactly* the same frequency as the carrier which was suppressed. For this reason, suppressed-carrier double-sideband systems have no practical application.

When the carrier is suppressed and only the upper *or* lower sidebands are transmitted, a highly intelligible signal may be obtained at the receiver even though the locally generated carrier differs a few cycles from the frequency of the carrier which was suppressed at the transmitter. A communications system utilizing but one group of sidebands with carrier suppressed is known as a "single sideband" system, and such systems are sometimes used for commercial point to point work, where rather elaborate equipment can be tolerated. The two chief advantages of the system are: (1) the effective power gain which results from putting all the radiated power in intelligence carrying sideband frequencies instead of mostly into radiated carrier, and (2) elimination of the selective fading and distortion that normally occurs in a conventional double sideband system when the carrier fades and the sidebands do not, consequently overmodulating the carrier, when there is interference due to multiple path transmission.

Because single-sideband equipment is complex and in limited use, the method whereby the carrier and one sideband are filtered out and a virtual carrier reinserted at the receiver will not be treated.

7-1 Systems of Amplitude Modulation

There are many different systems and methods for amplitude modulating a carrier, but most may be grouped under two general classifications: *variable efficiency* systems in which the average input to the stage remains constant with and without modulation and the variations in the efficiency of the stage in accordance with the modulating voltage accomplish the modulation; and *constant efficiency* systems in which the input to the stage is varied by one means or another to accomplish the modulation. The various systems under each classification have individual characteristics which make certain ones best suited to particular applications.

Variable Efficiency Modulation Since the average input remains constant in a stage employing variable efficiency modulation, and since the average power output of the stage increases with modulation, the limiting factor in such an amplifier is the plate dissipation of the tubes in the stage when they are in the unmodulated condition. Hence, for the best relation between tube cost and power output the tubes employed should have as high a plate dissipation rating per dollar as possible.

The plate efficiency in such an amplifier is doubled when going from the unmodulated condition to the peak of the modulation cycle. Hence, the unmodulated efficiency of such an amplifier must always be less than 45 per cent, since the maximum peak efficiency obtainable in a conventional amplifier is in the vicinity of 90 per cent. Since the peak efficiency in certain types of amplifiers will be as low as 60 per cent, the unmodulated efficiency in such amplifiers will be in the vicinity of 30 per cent.

Assuming a typical amplifier having a peak efficiency of 70 per cent, the following figures give an idea of the operation of an idealized efficiency-modulated stage adjusted for 100 per cent sine-wave modulation. It should be kept in mind that the plate voltage is constant at all times, even over the audio cycles.

Plate input without modulation.....	100 watts
Output without modulation.....	35 watts
Efficiency without modulation.....	35%
Input on 100% positive modulation peak (plate current doubles).....	200 watts
Efficiency on 100% positive peak.....	70%
Output on 100% positive modulation peak.....	140 watts
Input on 100% negative peak.....	0 watts
Efficiency on 100% negative peak.....	0%
Output on 100% negative peak.....	0 watts
Average input with 100% modulation.....	100 watts
Average output with 100% modulation (35 watts carrier plus 17.5 watts sideband).....	52.5 watts
Average efficiency with 100% modulation.....	52.5%

The classic example of efficiency modulation is the Class B linear r-f amplifier. Other common systems of efficiency modulation are control-grid modulation, screen-grid modulation, and suppressor-grid modulation. Cathode modulation is a combination of variable efficiency modulation and variable input modulation.

Class C Grid Modulation The most widely used system of efficiency modulation for communications work is Class C control-grid bias modulation. The distortion is slightly higher than for a properly operated Class B linear amplifier, but the efficiency is also higher, and the distortion can be kept within tolerable limits for communications work.

Class C grid modulation requires high plate voltage on the modulated stage, if maximum output is desired. The plate voltage is normally run about 50 per cent higher than for maximum output with plate modulation.

The driving power required for operation of a grid-modulated amplifier under these conditions is somewhat more than is required for operation at lower bias and plate voltage, but the increased power output obtainable overbalances the additional excitation requirement. Actually, almost half as much excitation is required as would be needed if the same stage were to be operated as a Class C plate-modulated amplifier. The resistor R across the grid tank of the stage serves as "swamping" to stabilize the r-f driving voltage. At least 50 per cent of the output of the driving stage should be dissipated in this swamping resistor under carrier conditions. If a reasonable amount of reserve excitation power is available and if a high-C grid tank is used on the grid-modulated stage, no swamping resistor will be required when the bias is at least 6 times cutoff, because the high tank losses under these conditions produce the same result as the swamping resistor.

A comparatively small amount of audio power will be required to modulate the amplifier stage 100 per cent. An audio amplifier having 20 watts output will be sufficient to modulate an amplifier with one kilowatt input. Proportionately smaller

amounts of audio will be required for lower powered stages. However, the audio amplifier that is being used as the grid modulator should, in any case, either employ low plate resistance tubes such as 2A3's, employ degenerative feedback from the output stage to one of the preceding stages of the speech amplifier, or be resistance loaded with a resistor across the secondary of the modulation transformer. This provision of low driving impedance in the grid modulator is to insure good regulation in the audio driver for the grid modulated stage. Good regulation of both the audio and the r-f drivers of a grid-modulated stage is quite important if distortion-free modulation approaching 100 per cent is desired, because the grid impedance of the modulated stage varies widely over the audio cycle.

Two circuits for obtaining grid-bias modulation are shown in Figure 3. Figure 3A illustrates the conventional method utilizing a regulated grid-bias power supply and a separate audio amplifier as the grid-bias modulator. This circuit is satisfactory and gives excellent results. The circuit of Figure 3B is somewhat simpler than that illustrated in (A) since the separate modulator stage has been dispensed with and the function combined with that of bias regulation in the single 6B4G tube shown. The regulator-modulator tube operates as a cathode-follower. The average d-c voltage on the control grid is controlled by the 70,000-ohm wire-wound potentiometer and hence this potentiometer adjusts the average grid bias on the modulated stage. However, a-c signal voltage is also impressed on the control-grid of the tube and since the cathode follows this a-c wave the incoming speech wave is superimposed on the average grid bias, thus effecting grid-bias modulation of the r-f amplifier stage. An audio voltage swing is required on the grid of the 6B4G of approximately the same peak value as will be required as bias-voltage swing on the grid-bias modulated stage. This voltage swing will normally be in the region from 50 to 200 peak volts. Up to about 100 volts peak swing can be obtained from a 6SJ7 tube as a conventional speech amplifier stage. The higher voltages may be obtained from a tube such as a 6J5 through an audio transformer of 2:1 or 2½:1 ratio.

With the normal amount of comparatively tight antenna coupling to the modulated stage, a non-modulated carrier efficiency of 40 per cent can be obtained with substantially distortion-free modulation up to practically 100 per cent. If the antenna coupling is decreased slightly from the condition just described, and the excitation is increased to the point where the amplifier draws the same input, carrier efficiency of 50 per cent is obtainable with tolerable distortion at 90 per cent modulation.

Tuning the Grid-Bias Modulated Stage It will be noticed, by reference to Figures 3A and 3B, that a special type of bias supply for the grid-modulated stage has been incorporated as a part of the schematic of the stage in each case. This was done purposely to make it clear that a special type of high-voltage bias supply is required for best operation of such an amplifier. The supply of Figure 3A has very good regulation up to about 75 ma. of grid current (the maximum capability of a single 2A3) and the voltage may be varied from nearly zero to about 700 volts; also, this particular supply may be constructed quite inexpensively.

The most satisfactory procedure for tuning a stage for grid-bias modulation of the Class C type is as follows. The amplifier should first be neutralized, and any possible tendency toward parasitics under any condition of operation should be eliminated. Then the antenna should be coupled to the plate circuit, the grid bias should be run up to the maximum available value, and the plate voltage and excitation should be applied. The

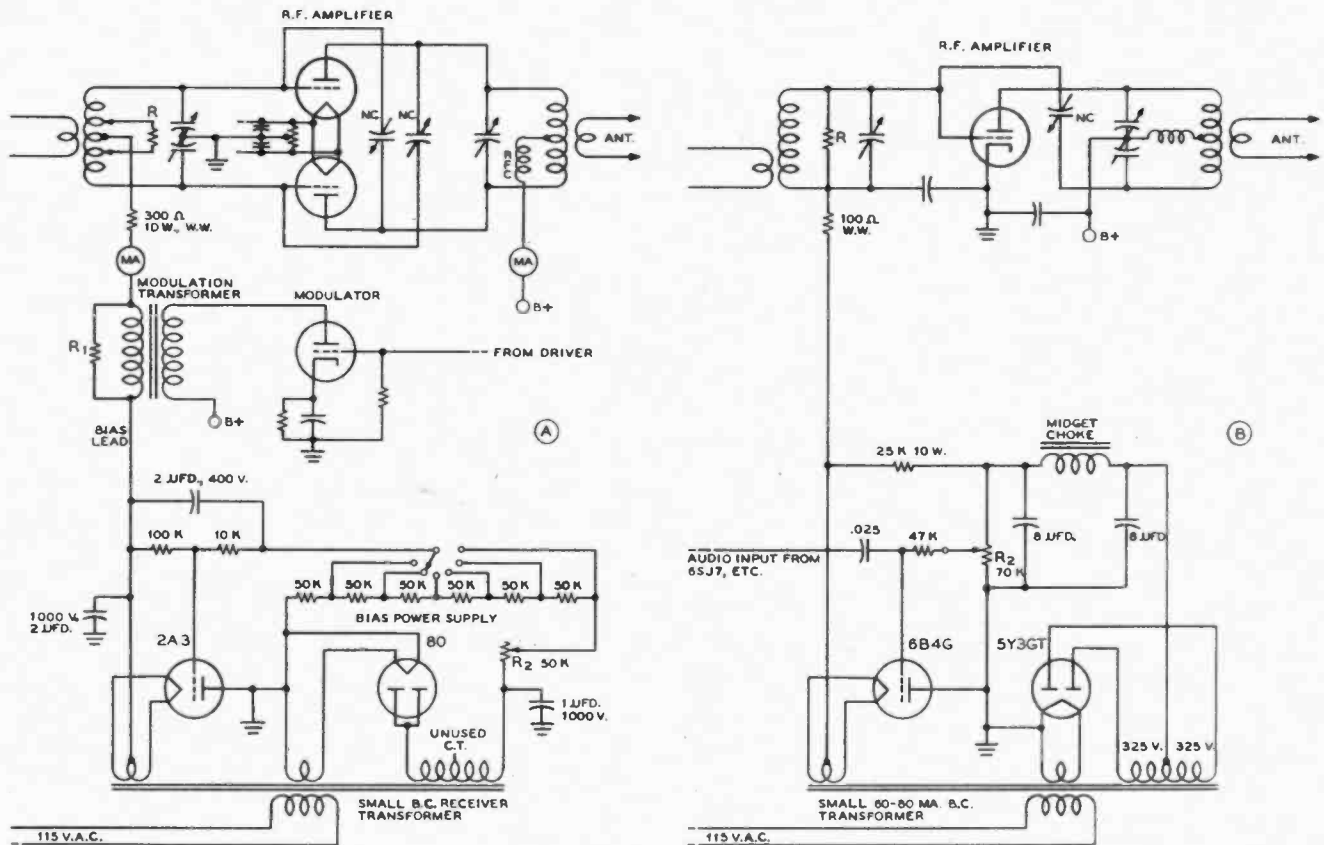

Figure 3.

GRID-BIAS MODULATION CIRCUITS.

The circuits of (A) and (B) show two practical circuits for obtaining grid-bias modulation of a Class C amplifier. Both arrangements will give satisfactory results but the new circuit arrangement shown at (B) is recommended since fewer components are required, the audio power amplifier stage is eliminated, and no modulation transformer is required. The grid of the 6B4-G modulator-bias regulator tube may be excited from a low level speech stage such as a 6J5 or a 6SJ7 since this tube requires no grid current for full modulation.

grid bias voltage should then be reduced until the amplifier draws the approximate amount of plate current it is desired to run, and modulation corresponding to about 80 per cent is then applied. If the plate current kicks up when modulation is applied, the grid bias should be reduced; if the plate meter kicks down, increase the grid bias.

When the amount of bias voltage has been found (by adjusting the fine control, R₁, on the bias supply) where the plate meter remains constant with modulation, it is more than probable that the stage will be drawing either too much or too little input. The antenna coupling should then be either increased or decreased (depending on whether the input was too little or too much, respectively) until the input is more nearly the correct value. The bias should then be readjusted until the plate meter remains constant with modulation as before. By slight jockeying back and forth of antenna coupling and grid bias, a point can be reached where the tubes are running at rated plate dissipation, and where the plate milliammeter on the modulated stage remains substantially constant with modulation.

The linearity of the stage should then be checked by any of the conventional methods; the trapezoidal pattern method employing a cathode-ray oscilloscope is probably the most satisfactory. The check with the trapezoidal pattern will allow the determination of the proper amount of gain to employ on the speech amplifier. Incidentally, too much audio power on the grid of the modulated stage should not be used in the tuning-up process, as the plate meter will kick quite erratically and it will be impossible to make a satisfactory adjustment.

Tubes for Grid Bias Modulation

If a grid bias modulated tube is run at or near maximum permissible rated plate voltage, the amount of carrier power that may be obtained is limited by the plate dissipation, rather than peak filament emission. Therefore, for good economy a tube should be chosen for the modulated stage which has a high plate dissipation rating in proportion to its cost.

Pentodes or beam tetrodes, especially the latter, may be control-grid modulated under Class C conditions with good efficiency, and less excitation is required than for a triode giving the same carrier power. The use of beam tetrodes is most satisfactory in transmitters where neutralization is a problem, as in multi-band quick-change transmitters.

High transconductance and a medium or high mu are desirable in a triode which is to be grid modulated.

Coupling Transformers for Grid Modulation

The modulator in a conventional circuit such as shown in Figure 3A should be capable of delivering at the secondary of the modulation transformer a distortionless output of at least 2 per cent and preferably 5 per cent of the d-c input to the modulated stage. If low-plate-resistance triodes such as 2A3's are employed, the secondary of the transformer need not be resistance loaded. If pentodes or beam-tetrode modulators are employed, the secondary of the modulation transformer should be shunted with a resistor having a resistance slightly higher than the value which gives maximum undistorted output power from the modulators.

The turns ratio of the transformer should be such that the

peak audio voltage developed across the secondary under normal operating conditions and full undistorted output from the modulator is equal to approximately twice cut off bias for the particular r-f tube or tubes and plate voltage used, regardless of the amount of bias actually employed.

Screen-Grid Modulation Modulation can be accomplished by varying the screen-grid voltage in an r-f screen-grid tube. The screen-grid voltage must be reduced to between one-half and one-third the value used for c-w operation. The r-f output is correspondingly reduced and the tube then operates as an efficiency-modulated device, somewhat similar to ordinary grid modulation.

Distortionless modulation is limited to about 80 per cent. The r-f excitation must have good regulation, as in a control grid bias modulated stage. Likewise, the control-grid bias must be provided from a low resistance source, by-passed for a.f. The excitation must be low, and as in control-grid modulation, is critical.

As screen-grid modulation does not compare favorably with Class C grid-bias modulation, it is seldom employed.

Suppressor Modulation Still another form of efficiency modulation can be obtained by applying audio voltage to the suppressor grid of a pentode tube which is operated Class C. A change in bias voltage on the suppressor grid will change the r-f output of a pentode tube; the application of audio voltage thus provides a simple method of obtaining modulation.

The suppressor grid is biased negatively to a point which reduces the plate efficiency to about half the maximum obtainable from the particular amplifier, or usually to about 35 per cent. The peak efficiency at the time of complete modulation must reach twice this value. It is difficult to obtain 100 per cent modulation without distortion, though 90 per cent to 95 per cent can easily be obtained and with good linearity.

The same modulator design problems apply to the suppressor-modulated transmitter as do to a grid-modulated amplifier, because the suppressor normally will be driven positive over the peak of the audio cycle at high modulation percentage. The control grid in the suppressor-modulated stage is driven to about the same degree as for c-w or plate modulation. The r-f excitation adjustment is not critical, but the excitation should be ample if good efficiency is to be obtained.

A medium-power suppressor-modulated amplifier is shown in Figure 4. An 804 as the amplifier will supply about 20 watts of carrier. An 803 may be substituted to increase the carrier output to about 50 or 60 watts. Either tube may be excited to full output by a 6L6 operating either as a frequency multiplier or as a crystal oscillator. A type 6F6 or 42 will serve as modulator for either tube.

It is possible to operate a suppressor-modulated amplifier stage as a doubler. The efficiency suffers somewhat but the voice quality will be found to be satisfactory.

The Class B Linear Amplifier The operation of the Class B linear amplifier has been discussed in Chapter 4, and hence will only be covered quite generally here. The linear amplifier is well suited for broadcast use, because by careful design and adjustment distortion can be kept at a negligible value, even at high modulation percentages. However, the efficiency is less than can be obtained with Class C grid-bias modulation.

The grid circuit of a linear amplifier is fed modulated r-f energy and the stage amplifies carrier and sidebands linearly. The stage is biased to "extended" cutoff with no excitation, so that when excitation is applied the plate current flows in 180° pulses. This long period of plate current flow limits the

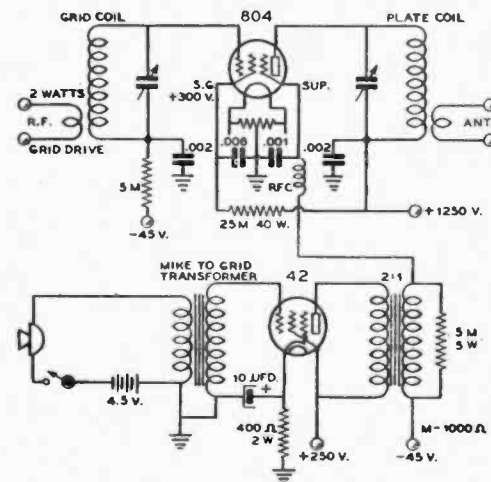

Figure 4.
TYPICAL SUPPRESSOR GRID-MODULATED AMPLIFIER.

Only the simplest form of speech equipment is shown, but a better microphone and conventional speech amplifier may be used. This circuit arrangement will be quite effective for modulation of tubes such as the 803, 4E27/8001, and HK-257B; the value of suppressor-grid bias will have to be determined in each case and will be somewhat greater for these tubes than shown in the circuit above.

theoretical peak efficiency to 78.5 per cent, the practical peak efficiency to about 65 per cent, and the average carrier efficiency to about 30 to 33 per cent.

The power output from a correctly operating linear amplifier will be about one-half the maximum plate dissipation of the stage, under the carrier conditions. The schematic of a linear amplifier is exactly the same as that of a conventional amplifier, whether single ended or push-pull, except that a swamping resistor is usually placed across the grid circuit of the stage. The excitation requirements for a Class B linear amplifier are somewhat less than for a Class C grid-modulated stage running at the same power input.

Input Modulation Systems Constant efficiency variable-input modulation systems operate by virtue of the addition of external power to the modulated stage to effect the modulation.

There are two general classifications that come under this heading; those systems in which the additional power is supplied as audio frequency energy from a modulator, usually called plate modulation systems, and those systems in which the additional power to effect modulation is supplied as direct current from the plate supply.

Under the former classification comes Heising modulation (probably the oldest type of modulation to be applied to a continuous carrier), Class B plate modulation, and series modulation. These types of plate modulation are by far the easiest to get into operation, and they give a very good ratio of power input to the modulated stage to power output; 65 to 80 per cent efficiency is the general rule. It is for these two important reasons that these modulation systems, particularly Class B plate modulation, are at present the most popular for communications work.

Modulation systems coming under the second classification are of comparatively recent development but have been widely applied to broadcast work. There are quite a few systems in this class. Two of the more widely used are the Doherty linear amplifier, and the Terman-Woodyard high-efficiency grid-modulated amplifier. Both systems operate by virtue of a carrier amplifier and a peak amplifier connected together by electrical quarter-wave lines. They will be described later in this section.

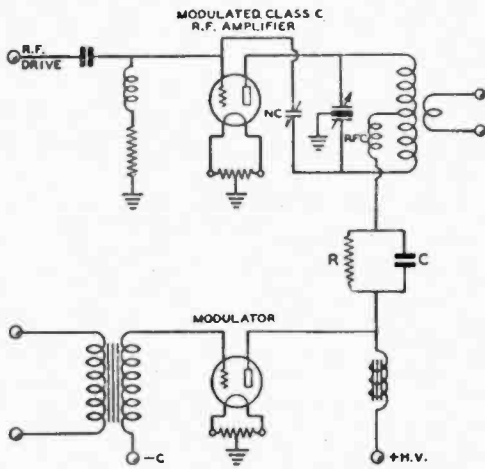

Figure 5.
HEISING PLATE MODULATION.

This type of modulation was the first form of plate modulation. It is sometimes known as "constant current" modulation. Because of the effective 1:1 ratio of the coupling choke, it is impossible to obtain 100 per cent modulation unless the plate voltage to the modulated stage is dropped slightly by resistor R. The capacitor C merely bypasses the audio around R, so that the full a-f output voltage of the modulator is impressed on the Class C stage.

Plate Modulation Plate modulation is the application of the audio power to the plate circuit of an r-f amplifier. The r-f amplifier must be operated Class C for this type of modulation in order to obtain a radio-frequency output which changes in exact accordance with the variation in plate voltage. The r-f amplifier is 100 per cent modulated when the peak a-c voltage from the modulator is equal to the d-c voltage applied to the r-f tube. The positive peaks of audio voltage increase the instantaneous plate voltage on the r-f tube to twice the d-c value, and the negative peaks reduce the voltage to zero.

The instantaneous plate current to the r-f stage also varies in accordance with the modulating voltage. The peak alternating current in the output of a modulator must be equal to the d-c plate current of the Class C r-f stage at the point of 100 per cent modulation. This combination of change in audio voltage and current can be most easily referred to in terms of audio power in watts.

In a sinusoidally modulated wave, the antenna current increases approximately 22 per cent for 100 per cent modulation with a pure tone input; an r-f meter in the antenna circuit indicates this increase in antenna current. The average power of the r-f wave increases 50 per cent for 100 per cent modulation, the efficiency remaining constant.

This indicates that in a plate-modulated radiotelephone transmitter, the audio-frequency channel must supply this additional 50 per cent increase in average power for sine-wave modulation. If the power input to the modulated stage is 100 watts, for example, the average power will increase to 150 watts at 100 per cent modulation, and this additional 50 watts of power must be supplied by the modulator when plate modulation is used. The actual antenna power is a constant percentage of the total value of input power.

One of the advantages of plate (or power) modulation is the ease with which proper adjustments can be made in the transmitter. Also, there is less plate loss in the r-f amplifier for a given value of carrier power than with other forms of modulation, because the plate efficiency is higher.

By properly matching the plate impedance of the r-f tube to the output of the modulator, the ratio of voltage and current swing to d-c voltage and current is automatically obtained.

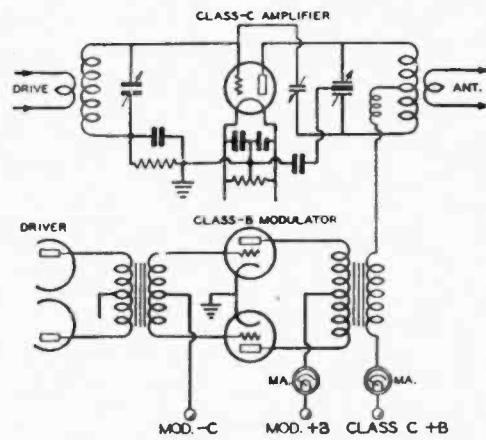

Figure 6.
CLASS B PLATE MODULATION.
This type modulation is the most practicable form of high level modulation for communications work.

The modulator should have a peak voltage output equal to the average d-c plate voltage on the modulated stage. The modulator should also have a peak power output equal to the d-c plate input power to the modulated stage. The average power output of the modulator will depend upon the type of waveform. If the amplifier is being Heising modulated by a Class A stage, the modulator must have an average power output capability of one-half the input to the Class C stage. If the modulator is a Class B audio amplifier, the average power required of it may vary from one-quarter to more than one-half the Class C input depending upon the waveform. However, the peak power output of any modulator must be equal to the Class C input to be modulated. This subject is completely covered in the section *Speech Waveforms*.

Heising Modulation Heising modulation is the oldest system of plate modulation, and usually consists of a Class A audio amplifier coupled to the r-f amplifier by means of a modulation choke coil, as shown in Figure 5.

The d-c plate voltage and plate current in the r-f amplifier must be adjusted to a value which will cause the plate impedance to match the output of the modulator, since the modulation choke gives a 1-to-1 coupling ratio. A series resistor, by-passed for audio frequencies by means of a capacitor, must be connected in series with the plate of the r-f amplifier to obtain modulation up to 100 per cent. The a-c or audio output voltage of a Class A amplifier does not reach a value equal to the d-c voltage applied to the amplifier and, consequently, the d-c plate voltage impressed across the r-f tube must be reduced to a value equal to the maximum available a-c peak voltage if 100% modulation is to be obtained without distortion.

A higher degree of distortion can be tolerated in low-power emergency phone transmitters which use a pentode modulator tube, and the series resistor and by-pass capacitor are usually omitted in such transmitters.

Class B Plate Modulation High-level Class B plate modulation is the least expensive method of plate modulation. Figure 6 shows a conventional Class B plate-modulated Class C amplifier.

The statement that the modulator output power must be one-half the Class C input for 100 per cent modulation is correct only if the waveform of the modulating power is a sine wave. Where the modulator waveform is unclipped speech, the average modulator power for 100 per cent modulation is considerably less than one-half the Class C input. If a modula-

tor is to be used *only with speech*, it seems logical that its design be based upon the peculiarities of speech rather than on the characteristics of the sine wave.

Power Relations in Speech Waveforms It has been determined experimentally that the ratio of peak to average power in a speech waveform is approximately 4 to 1 as contrasted to a ratio of 2 to 1 in a sine wave. This is due to the high harmonic content of such a waveform, and to the fact that this high harmonic content manifests itself by making the wave unsymmetrical and causing sharp peaks or "fingers" of high energy content to appear. Thus for unclipped speech, the *average* modulator plate current, plate dissipation, and power output are approximately one-half the sine wave values for a given *peak* output power.

Both peak power and average power are necessarily associated with waveform. *Peak* power is just what the name implies: the power at the peak of a wave. Peak power, although of the utmost importance in modulation, is of no great significance in a-c power work, except insofar as the *average* power may be determined from the peak value of a known wave form.

There is no time element implied in the definition of peak power; peak power may be instantaneous—and for this reason average power, which is definitely associated with time, is the important factor in plate dissipation. It is possible that the peak power of a given wave form be several times the average value; for a sine wave, the peak power is twice the average value, and for unclipped speech the peak power is approximately four times the *average* value. For 100 per cent modulation, the *peak* (instantaneous) audio power must equal the Class C input, although the average power for this value of peak varies widely depending upon the modulator wave form, being greater than 50 per cent for speech that has been clipped and filtered, 50 per cent for a sine wave, and about 25 per cent for typical unclipped speech tones.

As has been mentioned in a previous paragraph, it is possible to design a modulator stage to take advantage of the fact that the ratio between peak and average in an unclipped speech waveform is approximately four-to-one. In fact it was common practice to use a smaller modulator in this manner for speech work in the last few years before the recent war. This was, in fact, before it was fully realized that a clipped speech wave was fully as understandable as an unclipped one in the absence of noise and interfering signals, and that a fully modulated clipped speech wave was greatly more understandable in the presence of noise and interfering signals. This condition and the design factors involved are discussed in detail in Section 7-4 at the end of this chapter.

Class B Modulators A detailed discussion of the operating conditions for Class B a-f modulators has been given in Section 4-8 of Chapter 4. In addition, Table III in Chapter 4 lists recommended operating conditions for a large number of tubes which are commonly used in Class B modulator stages. Data is also given in Section 4-8 for the calculation of operating conditions for tubes as Class B modulators when it is desired to operate a pair of tubes under conditions different from those normally specified.

Modulation Transformer Calculations The modulation transformer is a device for matching the load impedance of the Class C amplifier to the recommended load impedance of the Class B modulator tubes. Modulation transformers intended for communications work are usually designed to carry the Class C plate current through their secondary windings, as shown in Figure 6. The manufacturer's ratings should be consulted to insure that the d-c plate current

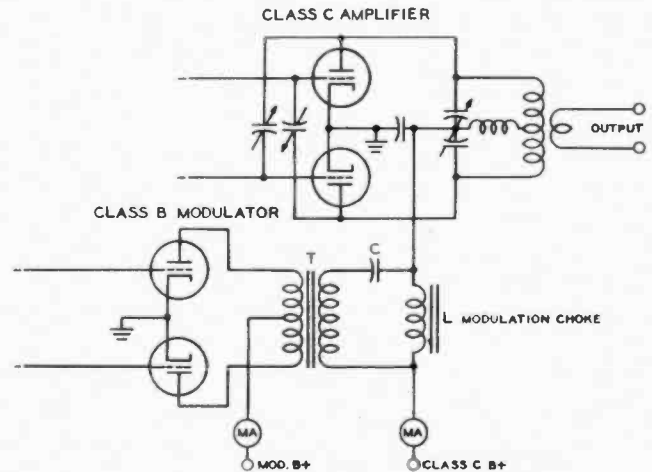

Figure 7.
ALTERNATE CLASS B MODULATION CIRCUIT.

The arrangement shown above feeds the plate current to the Class C modulated stage through a modulation choke as contrasted to running this current through the secondary of the modulation transformer as shown in Figure 6. When an adequate-size choke is used for L and a capacitor of moderate size for C, this arrangement will give improved low-frequency response over the circuit of Figure 6. It is for this reason that this circuit is commonly used for broadcast stations. The choke L should have an inductance high enough so that its inductive reactance will be at least equal to the Class C amplifier load impedance at the lowest frequency to be modulated. The capacitor C should have a capacitive reactance much lower than the Class C load impedance at the lowest frequency to be transmitted. The arrangement shown will give improved phase-shift characteristics for clipped speech waves over the simpler system shown in Figure 6.

being pulled through the secondary winding does not exceed the maximum rating.

A detailed discussion of the method of making modulation transformers has been given in Chapter 4 Section 4-8. However, to emphasize the method of making the calculation, an additional example will be given.

Suppose we take the case of a pair of HK-54 Gammatrons operating at a plate voltage of 2000 with 225 ma. of plate current. This amplifier would present a load resistance of 2000 divided by 0.225 amperes or 8888 ohms. The plate power input would be 2000 times 0.225 or 450 watts. By reference to Table III in Chapter 4 we see that a pair of 811 tubes operating at 1500 plate volts will deliver 450 peak watts of audio output. The plate-to-plate load resistance for these tubes under the specified operating conditions is 18,000 ohms. Hence our problem is to match the Class C amplifier load resistance of 8888 ohms to the 18,000-ohm load resistance required by the modulator tubes.

A 200-to-300 watt modulation transformer will be required for the job. If the taps on the transformer are given in terms of impedances it will only be necessary to connect the secondary for 8888 ohms (or a value approximately equal to this such as 9000 ohms) and the primary for 18,000 ohms. If it is necessary to determine the proper turns ratio required of the transformer it can be determined in the following manner. The square root of the impedance ratio is equal to the turns ratio, hence:

$$\sqrt{\frac{8888}{18000}} = \sqrt{0.494} = 0.703$$

The transformer must have a turns ratio of approximately 1-to-0.7 step down, total primary to total secondary. The greater number of turns always goes with the higher impedance, and vice versa.

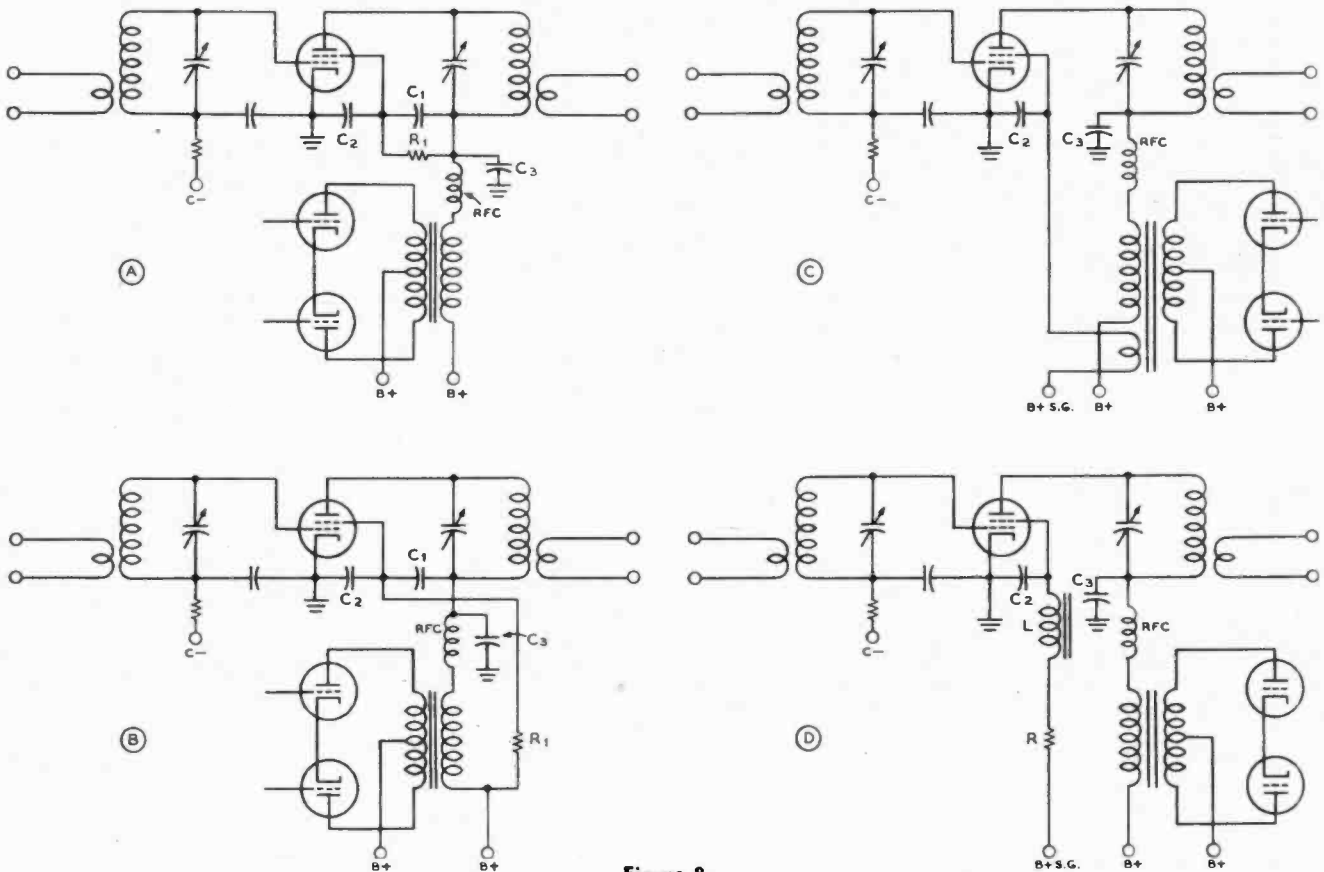

Figure 8.

PLATE MODULATION OF A SCREEN-GRID TUBE OR BEAM TETRODE.

The alternative arrangements for plate modulation of a beam tetrode or pentode shown in (A), (B), (C), and (D) above are described in detail in the text. The system shown at (D) is recommended for most applications.

Plate-and-Screen Modulation When *only* the plate of a screen-grid tube is modulated, it is impossible to obtain high-percentage linear modulation under ordinary conditions. The plate current of such a stage is not linear with plate voltage, and a dynatronic action usually takes place when the instantaneous plate voltage falls below the d-c screen voltage. These conditions prevent linear modulation. However, if the screen is modulated simultaneously with the plate, the instantaneous screen voltage drops in proportion to the drop in the plate voltage, and linear modulation can then be obtained. Four satisfactory circuits for accomplishing combined plate and screen modulation are shown in Figure 8.

The screen r-f by-pass capacitor, C_s , should not have a value greater than .01 $\mu\text{fd.}$, preferably not larger than .005 $\mu\text{fd.}$ It should be large enough to bypass effectively all r-f voltage without short-circuiting high-frequency audio voltages. The plate by-pass capacitor can be of any value from .002 $\mu\text{fd.}$ to .005 $\mu\text{fd.}$ The screen-dropping resistor, R_s , should reduce the applied high voltage to the value specified for operating the particular tube in the circuit. Capacitor C_1 is seldom required, yet some tubes may require this capacitor in order to keep C_s from attenuating the high audio frequencies. Different values between .002 and .0002 $\mu\text{fd.}$ should be tried for best results.

Figure 8C shows another method which uses a third winding on the modulation transformer, through which the screen-grid is connected to a low-voltage power supply. The ratio of turns between the two output windings depends upon the type of screen-grid tube which is being modulated. The turns ratio should be approximately equal to the ratio between the plate voltage and the screen voltage on the tube being modulated. The latter arrangement is more economical insofar as modu-

lator power is concerned, because there is no waste of audio power across a screen-grid voltage-dropping resistor. However, this loss is relatively small anyway with most tubes. The special transformer is not justified except perhaps for high power.

If the screen voltage is derived from a dropping resistor (*not* a divider) that is by-passed for r.f. but not a.f., it is possible to secure quite good modulation by applying modulation only to the plate, provided that the screen voltage and excitation are first run up as high as the tube will stand safely. Under these conditions, the screen tends to modulate itself, the screen voltage varying over the audio cycle as a result of the screen impedance increasing with plate voltage, and decreasing with a decrease in plate voltage. This circuit arrangement is illustrated in Figure 8B.

A similar application of this principle is shown in Figure 8D. In this case the screen voltage is fed directly from a low-voltage supply of the proper potential through a choke L. A conventional filter choke having an inductance from 10 to 20 henries will be satisfactory for L.

To afford protection of the tube when plate voltage is not applied but screen voltage is supplied from the exciter power supply, when using the arrangement of Figure 8D, a resistor of 3000 to 10,000 ohms can be connected in series with the choke L. In this case the screen supply voltage should be at least 1½ times as much as is required for actual screen voltage, and the value of resistor is chosen such that with normal screen current the drop through the resistor and choke will be such that normal screen voltage will be applied to the tube. When the plate voltage is removed the screen current will increase greatly and the drop through resistor R will increase to such a value that the screen voltage will be lowered to the

point where the screen dissipation on the tube will not be exceeded. However, the supply voltage and value of resistor R must be chosen carefully so that the maximum rated screen dissipation cannot be exceeded. The maximum possible screen dissipation using this arrangement is equal to: $W = E^2/4R$ where E is the screen supply voltage and R is the combined resistance of the resistor R in Figure 8D and the d-c resistance of the choke L. It is wise, when using this arrangement to check, using the above formula, to see that the value of W obtained is less than the maximum rated screen dissipation of the tube or tubes used in the modulated stage. This same system can of course also be used in figuring the screen supply circuit of a pentode or tetrode amplifier stage where modulation is not to be applied.

The modulation transformer for plate-and-screen-modulation, when utilizing a dropping resistor as shown in Figure 8A, is similar to the type of transformer used for any plate-modulated phone. The combined screen and plate current is divided into the plate voltage in order to obtain the Class C amplifier load impedance. The peak audio power required to obtain 100 per cent modulation is equal to the d-c power input to the screen, screen resistor, and plate of the modulated r-f stage.

Cathode Modulation Cathode modulation offers a workable compromise between the good plate efficiency but expensive modulator of high-level plate modulation, and the poor plate efficiency but inexpensive modulator of grid modulation. Cathode modulation consists essentially of an admixture of the two.

The efficiency of the average well-designed plate-modulated transmitter is in the vicinity of 75 to 80 per cent, with a compromise perhaps at 77.5 per cent. On the other hand, the efficiency of a good grid-modulated transmitter may run from 28 to maybe 40 per cent, with the average falling at about 34 per cent. Now since cathode modulation consists of simultaneous grid and plate modulation, in phase with each other, we can theoretically obtain any efficiency from about 34 to 77.5 per cent from our cathode-modulated stage, depending upon the relative percentages of grid and plate modulation.

Since the system is a compromise between the two fundamental modulation arrangements, a value of efficiency approximately half way between the two would seem to be the best compromise. Experience has proven this to be the case. A compromise efficiency of about 56.5 per cent, roughly half way between the two limits, has proven to be optimum. Calculation has shown that this value of efficiency can be obtained from a cathode-modulated amplifier when the audio-frequency modulating power is approximately 20 per cent of the d-c input to the cathode-modulated stage.

Cathode-Modulation Operating Curves Figure 9 shows a set of operating curves for cathode-modulated r.f. amplifier stages. The chart is a plot of the percentage of plate modulation (*m*) against plate circuit efficiency, audio power required, plate input wattage in per cent of the plate-modulated Class C rating, and output power in percentage of the Class C phone output rating. These last two curves are not of as great importance in designing new transmitters as are the curves showing the relationship between per cent plate modulation and plate circuit efficiency.

Optimum Operating Conditions As was mentioned before, the optimum operating condition for a normal cathode-modulated amplifier is that at which the audio power output of the cathode modulator is about 20 per cent of the d-c input to the modulated stage. Under these conditions the plate efficiency will be in the

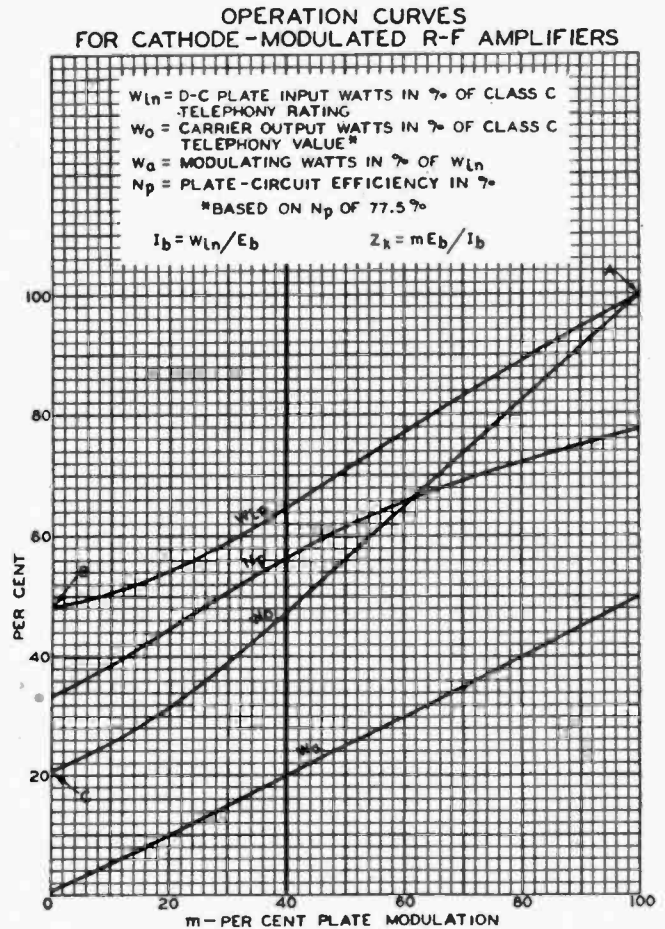

Figure 9.

vicinity of 56.5 per cent (between 54 and 58 per cent in a practical transmitter). The limiting factor in an efficiency-modulated amplifier of this type is, to a large extent, plate dissipation. If, under the conditions given above, the plate dissipation of the tube under carrier conditions is less than the rated value, the plate input can be increased until rated plate dissipation is reached. The plate dissipation for any condition of operation can easily be determined by reference to Figure 9 and a little calculation. Determine the input, and from the efficiency value given, figure the power output from the stage. Subtract this from the plate input, and the result is the amount that the tube will be required to dissipate.

Cathode Impedance The impedance of the cathode circuit of an amplifier which is being cathode modulated is an important consideration in the selection of the transformer which is to be used to couple the modulator. The cathode impedance of an amplifier is equal to the peak modulating voltage divided by the peak a-f component of the plate current of the stage. The peak modulating voltage is equal to the plate voltage times *m* (the per cent plate modulation).

$$\text{Hence: } Z_k = m \frac{E_p}{I_p}$$

Or, simply, the cathode impedance is equal to the per cent plate modulation (expressed as a decimal; e.g., 0.4 for 40%) times the plate voltage, divided by the plate current.

Cathode Modulator A typical cathode-modulated r-f amplifier is shown in Figure 10. The modulator which is used to feed the audio into the cathode circuit of the modulated stage should preferably have a power output

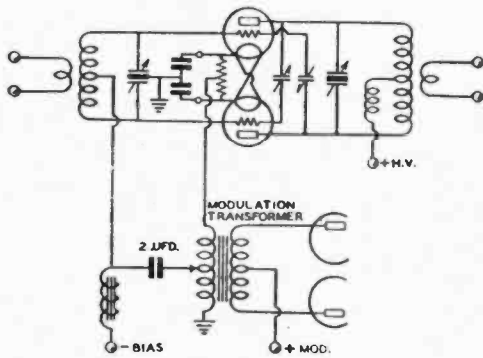

Figure 10.

CONVENTIONAL CATHODE MODULATION.

The modulation transformer in series with the cathode return of the modulated stage must match the cathode impedance of this stage. The choke in series with the grid return of the stage should have from 15 to 40 henrys inductance and should be capable of carrying the full grid current of the stage. The grid tap on the modulation transformer is varied, after the stage has been placed into operation, to give the best modulation pattern.

of 20 per cent of the d-c input to the stage, for 40 per cent plate modulation. Although this is the recommended percentage of plate modulation, satisfactory operation may be had with other percentage values than this provided the proper operating values are taken from Figure 9. The modulator tubes may be operated Class A, Class AB, or Class B, but it is recommended that some form of degenerative feedback be employed around the modulator tubes when they are to be operated in any manner other than Class A. This is particularly true of beam tetrodes when used as modulators; if some form of feedback is not used around them the harmonic distortion can easily be serious enough to be objectionable, since the cathode-modulated stage does not present a strictly linear impedance.

The transformer which couples the modulator to the cathode circuit of the modulated amplifier should match the cathode impedance, as calculated by the formula above, and in addition should have a number of taps so that the proper amount of audio voltage will be impressed upon the grid of the stage. In most cases one of the conventional multi-match output transformers will be satisfactory for the job, the cathode lead and the ground terminal of the stage being connected to the proper taps to give the desired value of impedance. The stage is then coupled to a cathode-ray oscilloscope so that the modulated waveform is shown on the screen. As the stage is being modulated, the grid is tapped varying amounts up and down on the modulation transformer until the best waveform is obtained on the screen of the oscilloscope. The more closely the grid is tapped to the cathode, the less will be the amount of audio voltage upon the grid. On the other hand, if the grid return is grounded, the full cathode swing will be placed upon the grid. It will be found that low- μ tubes will require a larger percentage of the total cathode swing upon them than will tubes with a higher μ factor. Hence, high- μ tubes will be tapped closer to cathode; low- μ tubes will be tapped more closely to ground.

Excitation The r-f driver for a cathode-modulated stage should have about the same power output capabilities as would be required to drive a c-w amplifier to the same input as it is desired to drive the cathode-modulated stage. However, some form of excitation control should be available since the amount of excitation power has a direct bearing on the linearity of a cathode-modulated amplifier stage. If link coupling is used between the driver and the modulated stage, variation in the amount of link coupling will afford ample excitation variation. If much less than 40% plate modula-

tion is employed, the stage begins to resemble a grid-bias modulated stage, and the necessity for good r-f regulation will apply.

Biasing Systems Any of the conventional biasing arrangements which are suitable for use on a Class C amplifier are also suitable for use with a cathode-modulated stage. Battery bias, grid leak bias, and power supply bias all are usable in their conventional fashion; cathode bias may be used if the bias resistor is by-passed with a high capacitance electrolytic capacitor. In any case the bias voltage should be variable or adjustable so that the optimum value for distortionless modulation can be found. If grid-leak or cathode bias is used, the value of the grid leak or cathode resistor should be adjustable. Grid-leak bias is not recommended if the per cent plate modulation is less than 30%, as the stage then is essentially a grid-modulated amplifier, requiring a well-regulated bias source.

The Doherty and the Terman-Woodyard Modulated Amplifiers

These two amplifiers will be described together since they operate upon very similar principles. Figure 11 shows a greatly simplified schematic diagram of the operation of both types. Both systems operate by virtue of a carrier tube (V_1 in both Figures 11A and 11B) which supplies the unmodulated carrier, and whose output is reduced to supply negative peaks, and a peak tube (V_2) whose function is to supply approximately half the positive peak of the modulation cycle and whose additional function is to lower the load impedance on the carrier tube so that it will be able to supply the other half of the positive peak of the modulation cycle.

The peak tube is enabled to increase the output of the carrier tube by virtue of an impedance inverting line between the plate circuits of the two tubes. This line is designed to have a characteristic impedance of one-half the value of load into which the carrier tube operates under the carrier conditions. Then a load of one-half the characteristic impedance of the quarter-wave line is coupled into the output. By experience with quarter-wave lines in antenna-matching circuits we know that such a line will vary the impedance at one end of the line in such a manner that the geometric mean between the two terminal impedances will be equal to the characteristic impedance of the line. Thus, if we have a value of load of *one-half* the characteristic impedance of the line at one end, the other end of the line will present a value of *twice* the characteristic impedance of the line to the carrier tube V_1 .

This is the situation that exists under the carrier conditions when the peak tube merely floats across the load end of the line and contributes no power. Then as a positive peak of modulation comes along, the peak tube starts to contribute power to the load until at the peak of the modulation cycle it is contributing enough power so that the impedance at the load end of the line is equal to R , instead of the $R/2$ that is presented under the carrier conditions. This is true because at a positive modulation peak (since it is delivering full power) the peak tube subtracts a negative resistance of $R/2$ from the load end of the line.

Now, since under the peak condition of modulation the load end of the line is terminated in R ohms instead of $R/2$, the impedance at the *carrier-tube* will be reduced from $2R$ ohms to R ohms. This again is due to the impedance inverting action of the line. Since the load resistance on the carrier tube has been reduced to half the carrier value, its output at the peak of the modulation cycle will be doubled. Thus we have the necessary condition for a 100 per cent positive modulation peak; the amplifier will deliver four times as much power as it does under the carrier conditions.

On negative modulation peaks the peak tube does not con-

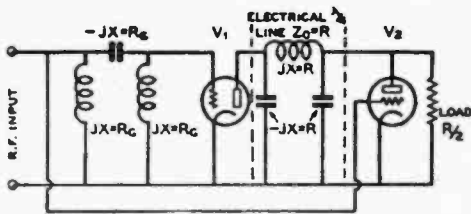

Figure 11-A.

tribute; the output of the carrier tube is reduced until on a 100 per cent negative peak its output is zero.

The Electrical Quarter-Wave Line While an electrical quarter-wave line (consisting of a pi network with the inductance and capacitance legs having a reactance equal to the characteristic impedance of the line)

does have the desired impedance-inverting effect, it also has the undesirable effect of introducing a 90° phase shift across such a line. If the shunt elements are capacitances, the phase shift across the line leads by 90° ; if they are inductances, the phase shift lags by 90° . Since there is an undesirable phase shift of 90° between the plate circuits of the carrier and peak tubes, an equal and opposite phase shift must be introduced in the exciting voltage to the grid circuits of the two tubes so that the resultant output in the plate circuit will be in phase. This additional phase shift has been indicated in Figure 11A and a method of obtaining it has been shown in Figure 11B.

Comparison Between Linear and Grid Modulator The difference between the Doherty linear amplifier and the Terman-Woodyard grid-modulated amplifier is the same as the difference between any linear

and grid-modulated stages. Modulated r.f. is applied to the grid circuit of the Doherty linear amplifier with the carrier tube biased to cutoff and the peak tube biased to the point where it draws substantially zero plate current at the carrier condition. In the Terman-Woodyard grid-modulated amplifier the carrier tube runs Class C with comparatively high bias and high plate efficiency, while the peak tube again is biased so that it draws almost no plate current. Unmodulated r.f. is applied to the grid circuits of the two tubes and the modulating voltage is inserted in series with the fixed bias voltages. From one-half to two-third as much audio voltage is required at the grid of the peak tube as is required at the grid of the carrier tube.

Operating Efficiencies The resting carrier efficiency of the grid-modulated amplifier may run as high as is obtainable in any Class C stage, 80 per cent or better. The resting carrier efficiency of the linear will be about as good as is obtainable in any Class B amplifier, 60 to 65 per cent. The overall efficiency of the bias-modulated amplifier at 100 per cent modulation will run about 75 per cent; of the linear, about 60 per cent.

In Figure 11B the circuits are detuned enough to give an effect equivalent to the shunt elements of the quarter-wave "line" of Figure 11A. At resonance, the coils L_1 and L_2 in the grid circuits of the two tubes have each an inductive reactance equal to the capacitive reactance of the capacitor C_1 . Thus we have the effect of a pi network consisting of shunt inductances and series capacitance. In the plate circuit we want a phase shift of the same magnitude but in the opposite direction; so our series element is the inductance L_3 whose reactance is equal to the characteristic impedance desired of the network. Then the plate tank capacitors of the two tubes C_2 and C_3 are increased an amount past resonance, so that

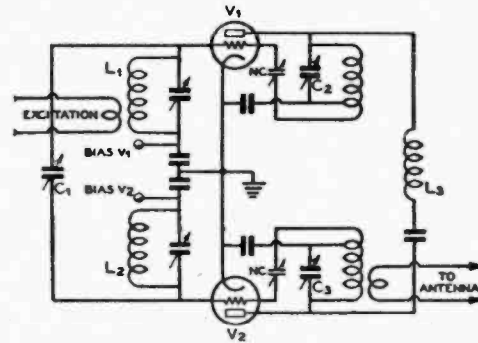

Figure 11-B.

SIMPLIFIED SCHEMATICS OF "HIGH EFFICIENCY" LOW LEVEL MODULATED STAGE.

The basic system, comprising a "carrier tube" and a "kicker tube", is the same for either bias modulation or excitation modulation. The operation is described in the accompanying text.

they have a capacitive reactance equal to the inductive reactance of the coil L_3 . It is quite important that there be no coupling between the inductors.

Although both these types of amplifiers are highly efficient and require no high-level audio equipment, they are difficult to adjust—particularly so on the higher frequencies—and it would be an extremely difficult problem to design a multi-band rig employing the circuit. However, the grid-bias modulation system has advantages for the high-power transmitter that may make some amateurs interested more than academically in the circuit.

Other High-Efficiency Modulation Systems Many other high-efficiency modulation systems have been described since about 1936. The majority of these, however, have been applied neither by commercial interests nor by amateurs. In most cases the circuits are difficult to adjust, or they have other undesirable features which make their use impracticable alongside the more conventional modulation systems. Nearly all these circuits have been published in the *I.R.E. Proceedings* and the interested reader can refer to them in back copies of that journal.

7-2 Microphones

A microphone is a *transducer*, a converter of mechanical to electrical energy. It usually, but not necessarily, consists of a diaphragm which moves in accordance with the compressions and rarefactions of the air called *sound waves*. The diaphragm then actuates some device which changes its electrical properties in accordance with the amount of physical movement.

If the diaphragm is very tightly stretched, the natural period of its vibration can be placed at a frequency which will be out of range of the human voice. This obviously reduces the sensitivity of the microphone, yet it greatly improves the uniformity of response to the wide range encountered for voice or musical tones. If the natural mechanically resonant period of the diaphragm falls within the voice range, the sensitivity is greatly increased near the resonant frequency. This results in distorted output if the diaphragm is not heavily damped, a familiar example being found in the old-type land-line telephone microphone.

A good microphone must respond equally to all voice frequencies; it must not introduce noise, such as hiss; it must have sufficient sensitivity to eliminate the need for excessive audio amplification; its characteristics should not vary with changes in temperature, humidity, or position, and its characteristics should remain constant over a useful period of life.

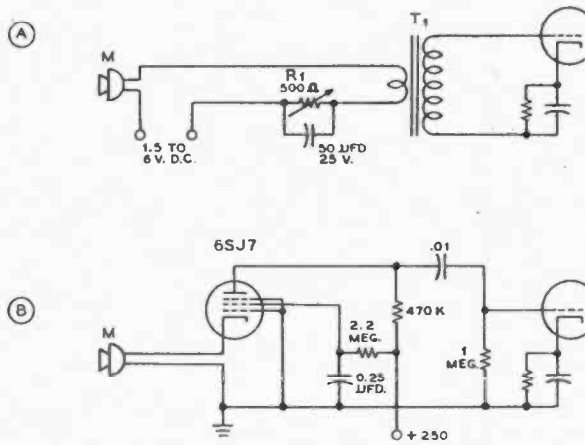

Figure 12.

CIRCUITS FOR CARBON MICROPHONES.

The conventional circuit shown at (A) uses the variable resistor R_1 both as a gain control and to allow the use of the minimum amount of button current which will give adequate gain. The microphone transformer T_1 usually has a primary of about 100 ohms and a secondary impedance of from 100,000 ohms to 500,000 ohms, thus permitting high voltage gain.

In the circuit shown at (B) the microphone transformer and the separate source of microphone current have been eliminated. The cathode current of the 6SJ7 serves as the microphone current and, since the control grid of the tube is grounded, the microphone impedance is effectively matched to the cathode input impedance of the 6SJ7 tube. If desired the 1-megohm gridleak on the following stage may be replaced with a 1-megohm potentiometer as a gain control.

Carbon Microphone Carbon microphones can be divided into two classes: (1) *single-button*, (2) *double-button*. The single-button microphone consists of a diaphragm which exerts a mechanical pressure on a group of carbon granules. These granules are placed behind the diaphragm between two electrodes, one of which is secured directly to the diaphragm and moves in accordance with the vibration of the diaphragm. This vibration changes the pressure on the carbon granules, resulting in a change of electrical resistance to current flowing between the electrodes, the direct current being supplied from an external source. The variation in resistance causes a change in the current which flows through the primary winding of a coupling transformer, thereby inducing a voltage in the secondary winding of this transformer. This voltage is then amplified as may be required. (See Figure 12.)

Single-button microphones are useful for operation in portable transmitters because their sensitivity is greater than that of other types of microphones, thereby requiring less audio amplification to supply audio modulating power to the transmitter. They can be made quite rugged, another desirable feature for portable or mobile use.

The earlier type single button microphones had a high hiss level and a bad resonance peak in the middle of the voice range. However, the latest types have been improved to the extent that they have fair fidelity and excellent intelligibility. The hiss level is sufficiently low that it is not noticed when the microphone is used close to the lips at normal voice level. When the microphone is used close to the lips, second harmonic distortion generated by the microphone reaches a significant magnitude, but is not excessively high for communications work.

Most of the newer single-button microphones are not positional, which means that they can be shaken during use or operated in any position without noticeable change in characteristics. Single-button carbon microphones usually have a d-c resistance of from 30 to 100 ohms. The effective impedance is the same as the d-c resistance. The maximum permissible button current will vary with the particular make of microphone, but usually is from 50 to 75 ma. Excessive button current will cause the microphone to become noisy if allowed to persist.

When only a comparatively narrow band of voice frequencies need be considered, as in communications work, it is possible to design a microphone input transformer with a very high step-up ratio. When such a transformer is used and maximum permissible button current is applied to the microphone, as much as 25 volts peak will be obtained across the secondary when speaking directly into the microphone at normal voice level.

In order to conserve battery drain and prolong the useful life of the microphone button, it is recommended that for a volume control a rheostat be employed in series with the microphone, rather than the more conventional potentiometer volume control across a transformer secondary. By choosing a supply voltage suitable for the particular microphone and amplifier employed, sufficient volume range adjustment can be obtained in this manner. The rheostat (R_1 in Figure 12A) preferably should be wirewound, and should be bypassed with a high-capacitance low voltage electrolytic capacitor.

When the microphone voltage is taken from a 6-volt storage battery which also supplies a vibrator pack or dynamotor, a "hash filter" usually will be required in order to prevent undesirable hum modulation via the microphone circuit. A very low resistance, iron core choke, bypassed at the input with a 0.5 μfd. paper capacitor and at the output by a 50 μfd. electrolytic capacitor make a satisfactory filter.

Double-Button Microphones The double-button microphone has two groups of carbon granules arranged in small containers on either side of the diaphragm. This push-pull effect minimizes the even-harmonic distortion. The diaphragm is normally stretched to such an extent that

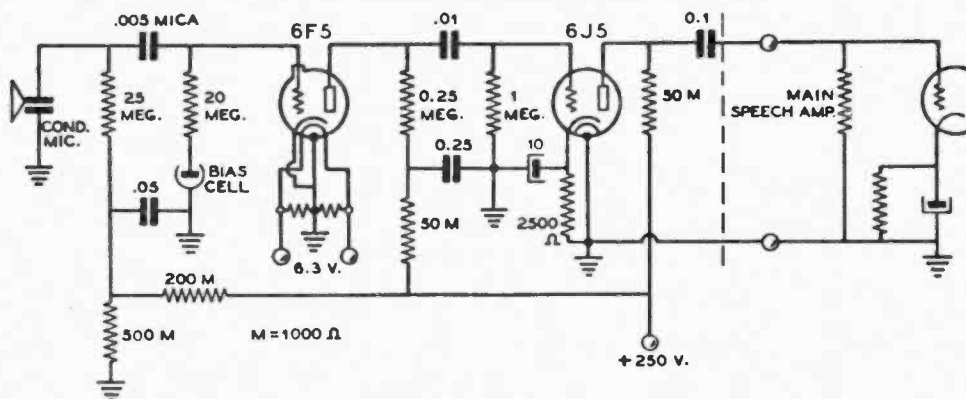

Figure 13.

TYPICAL CAPACITOR MICROPHONE PREAMPLIFIER.

A preamplifier of this general type may be used to raise the level of a capacitor microphone to a point where it can be fed into the input of a normal speech amplifier. The preamplifier is constructed as an integral part of the capacitor microphone case, providing a very short grid lead to the first tube and complete shielding of the microphone and amplifier. The preamplifier should preferably be fed from a separate, well-filtered plate supply.

Figure 14.
RECOMMENDED SPEECH AMPLIFIER
INPUT CIRCUIT.

This is a simple and conventional speech amplifier circuit for operating out of a crystal, high-impedance dynamic, or other low-level microphone. The voltage gain will be in the vicinity of 2300, which means that the amplifier will have a gain of about 67 db. With a crystal mike with output of -50 db the output of the 6J5 will be about plus 17 db; this is ample to drive a pair of 2A3's as a driver for a class B modulator. In this case a push-pull input transformer would be used in the plate circuit of the 6J5. If it is desired to feed a low-impedance line, a plate-to-line transformer should be used in the 6J5 plate circuit.

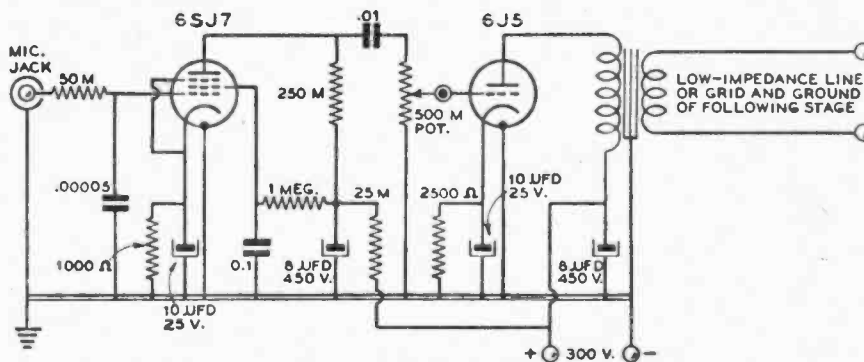

its natural period is between 6,000 and 8,000 cycles per second. This reduces the sensitivity of the microphone, and greater audio amplification is needed to secure the same output as from a single-button carbon microphone. On the other hand, the tone quality from the double-button microphone is better. The hiss is aggravated by the fact that the output of the microphone is much lower (20 to 45 db) than that of a single-button microphone for a given button current.

The double-button microphone was very popular a decade or two ago, but now is seldom used.

Capacitor Microphones A capacitor (or "condenser") microphone has a better frequency response than a carbon microphone, and it does not produce a hiss. This type of microphone consists of a highly damped or stretched diaphragm mounted very close to a metal plate but insulated from the plate. The movement of the diaphragm changes the spacing between the two electrodes, resulting in a change in electrical capacitance. When a d-c polarizing voltage is applied across the plates an a-c voltage will be generated when the diaphragm is actuated, by reason of the change in capacitance between the plates. This voltage can then be amplified by means of vacuum tubes.

The diaphragm of a typical capacitor microphone is made of duralumin sheet, approximately 1/1000 inch thick, with approximately the same spacing between the diaphragm and the rear heavy plate electrode. The output is approximately 75 db below an ordinary single-button carbon microphone with unstretched diaphragm.

The low output of a capacitor microphone necessitates considerable preamplification, the first stage being located, of necessity, very close to the microphone. The output impedance is extremely high and the unit must, therefore, be well shielded in order to prevent r-f and 60-cycle a-c hum pickup. It is sensitive to changes in barometric pressure and humidity. More modern types of microphones are replacing the capacitor type for all except very specialized sound measurement work. A typical capacitor microphone preamplifier is illustrated in Figure 13.

Crystal Microphones The crystal microphone operates on the principle that a change in dimensions of a piezo-electric material, such as a Rochelle salt crystal, generates a small a-c voltage which can be amplified by means of vacuum tubes. No d-c polarizing voltage or current or coupling transformer is required for the crystal microphone; thus, it is a very simple device to connect into an audio amplifier.

Crystal microphones can be divided into two classifications: (1) the diaphragm type, (2) the grille type.

The diaphragm type is relatively inexpensive, and consists of a semifloating diaphragm which subjects the crystal to de-

formation in accordance with the applied sound pressure. The fidelity is equal to that of most two-button carbon microphones, and there is no background noise or hiss generated in the microphone itself.

The grille type consists of a group of crystals connected in series or series-parallel, for the purpose of obtaining adequate electrical output without aid of a diaphragm.

The output level varies between -55 db and -80 db for various types of crystal microphones. The grille type is less directional to sound pickup than most other types, and is capable of almost perfect fidelity. However, they have from 10 to 25 db less output than the diaphragm type.

The crystal element used in both types is damaged permanently by high ambient temperatures. This limits the usefulness for certain applications, but nevertheless the crystal microphone is the most widely used high quality microphone for communications and public address use. Recent designs of crystal microphones have an improved type of crystal element which will withstand higher ambient temperature than earlier types.

Velocity or Ribbon Microphones The velocity or ribbon-type microphone has a thin, corrugated, metal strip diaphragm which is loosely supported between the poles of a horseshoe magnet. A minute current is induced in this strip when it moves in a magnetic field, and this current can be fed to the primary of a step-up-ratio transformer of high ratio because of the very low impedance of the ribbon.

The microphone output must be amplified by means of a very high gain preamplifier, because the output level is around -85 db. This type of microphone is rugged and simple in construction. It cannot be used for close talking without over-emphasizing the lower frequencies, and should therefore be placed at least 2 feet from the source of sound. It is very sensitive to a-c hum pickup, which is one of the principal reasons why it is not more widely used outside of broadcast applications.

The impedance of the ribbon is so low that it is difficult to design a ribbon-to-grid transformer with good fidelity. For best quality, two transformers are usually used in cascade: ribbon-to-200 ohms and 200 ohms-to-grid.

The ribbon microphone has excellent fidelity. The loosely supported ribbon has a natural period of vibration of but a few cycles a second, which serves the same purpose as stretching the diaphragm of a diaphragm type microphone to resonate above the useful range. However, the ribbon is vulnerable to wind currents, and is easily damaged by a strong current of air unless protected by a suitable wind screen.

The ribbon microphone is bi-directional, having a figure-eight pattern with two complete nulls displaced 180 degrees.

The "boominess" which results from talking very close to

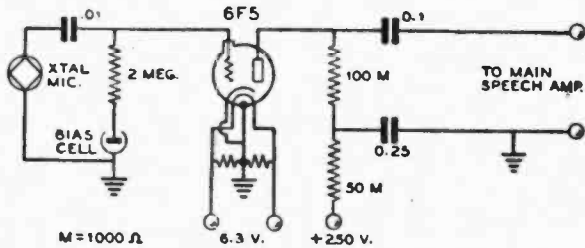

Figure 15.

SIMPLE PRE-AMPLIFIER OR SPEECH AMPLIFIER INPUT STAGE.

This amplifier stage makes a good input stage, providing about 35 db gain with very low hum and tube noise.

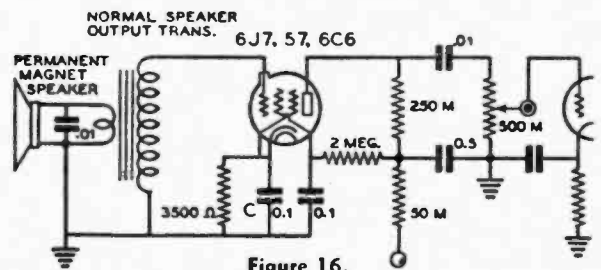

Figure 16.

HIGH-GAIN INPUT STAGE USING PENTODE.

This circuit will contribute slightly more tube noise than the circuit of Figure 15, but is satisfactory for all except the lowest level microphones. The small PM type speaker used as a microphone provides adequate fidelity for communications work, at low cost. A regular dynamic microphone may be substituted. The voltage gain of the stage is over 40 db.

a ribbon velocity microphone is caused by the fact that the diaphragm does not work on the sound pressure of the wave, as in most microphones, because both sides of the ribbon are exposed. Instead, the ribbon follows the *particle velocity* of the sound wave. The ratio of particle velocity to sound pressure increases rapidly when the distance from the sound source to the microphone is made much less than a wavelength. Because the distance measured in wavelength is much shorter for the lower frequencies, low frequencies are accentuated when the sound source is close, but normal when the distance is a considerable fraction of a wavelength at the lowest frequency present.

Dynamic Microphone The dynamic (moving coil) type of microphone operates on the same general principle as the ribbon microphone except that it is a pressure-operated device (only one side of the diaphragm exposed to the sound wave). A small coil of wire, actuated by a diaphragm, is suspended in a magnetic field, and the movement of the coil in this field generates an alternating current. The output impedance is approximately 30 ohms as against approximately 1 ohm for the ribbon type of microphone. The output level of the high fidelity types is about -85 db, the level varying with different makes. The output level of the public-address types is somewhat higher, and the fidelity is almost as good. This type of microphone is quite rugged, but has the disadvantage of picking up hum when used close to any power transformers.

A very satisfactory dynamic microphone can be made from a single earphone of the dynamic type taken from a headset such as the ANB-H-1A which has been available on the surplus market for a reasonable price. Alternatively, an inexpensive dynamic microphone can be made from a small permanent-magnet dynamic loudspeaker. One of the newer 5-inch types with alloy magnet will give surprising fidelity at relatively high output level.

A shielded cable and plug are essential to prevent hum pickup. The unit can be mounted in any suitable type of container. The circuit diagram is shown in Figure 16.

Directional Effects Crystal microphones, as well as those of some other types, can be mounted in a spherical housing with the diaphragm oriented horizontally in order to secure a non-directional effect. Decidedly unidirectional effects also may sometimes be required and microphones for this purpose are commercially available.

Noise Cancelling Microphones By exposing both sides of the diaphragm of a single-button microphone to the sound waves, it will operate as a velocity or pressure gradient device. The increase in the ratio of particle velocity to sound pressure at very close distances (covered under the velocity microphone) then can be exploited to ad-

vantage to obtain a microphone which actually discriminates against sounds emanating at a distance from the microphone. A close-talking carbon microphone giving a reduction in ambient background noise level of from 15 to 20 db over conventional close-talking microphones utilizes this principle. The microphone is corrected acoustically to compensate for the "boominess" that ordinarily would result from talking directly into a velocity microphone. Because of the compensation, the bass response is poor for distant sounds, but because of the specific close-talking application of the microphone this is of academic interest.

Microphones of this type can be used successfully in locations of ambient noise so high that it is difficult or impossible to hear one's own voice.

7-3 Speech Amplifiers

That portion of the audio channel between the microphone or its preamplifier and the power amplifier or modulator stage can be defined as the *speech amplifier*. It consists of from one to three stages of *voltage amplification* with resistance, impedance, or transformer coupling between stages. The input level is approximately -70 db when the speech amplifier is designed for operation from a diaphragm-type crystal microphone. Several speech-amplifier input circuits have been shown on the preceding pages, and a number of complete speech amplifiers are shown in Chapter 24, *Speech and Amplitude Modulation Equipment*.

It is possible to dispense with the preamplifier with certain types of low-level microphones by designing the speech amplifier input to work at -100 db or so, but it is better practice and entails less constructional care if a speech amplifier with less gain is used, in conjunction with a preamplifier to make up the required overall amplification. Less trouble with hum and feedback will be encountered with the latter method.

Designing a speech amplifier to work at -70 db is comparatively easy, as there is little trouble from power supply hum getting into the input of the amplifier by stray capacitive or inductive coupling.

Vacuum-Tube Amplifiers A detailed discussion of vacuum-tube amplifiers of various types has been given in Chapter 4. However, the more general considerations involved in speech-amplifier design are given in the following paragraphs.

Amplifier Gain Calculations The power gain in amplifiers, or the power loss in attenuators, can be conveniently expressed in terms of db *units*, which are an expression of ratio between two power levels. The calculation of db gain or loss is given in Chapter 15.

Phase Inverters Quite frequently in the design of a speech amplifier it is desirable to go from a single-ended stage into a push-pull power output stage, or a push-pull driver for Class B grids. A push-pull input transformer can be used to obtain the 180°-out-of-phase voltages necessary for the grids of the output tubes. But good quality push-pull input transformers are expensive and have a tendency to pick up inductive hum.

A detailed discussion of phase-inverter circuits has been given in Section 4-4 of Chapter 4. Figure 17 shows two additional phase-inverter circuits which have proved to give excellent results in all normal types of applications. Both make use of degenerative feedback to stabilize and equalize the voltages developed across the two halves of the output circuit. The circuit shown at (A) can be used with any two tubes of the low-power types usually employed in low-level audio work. One of the most satisfactory arrangements is to use a dual tube for both V_1 and V_2 . The 6N7, 6J6, 6F8-G, 6SC7, 6SN7, 6SL7, 7F7, and 6Z7-G twin triodes all are suitable for this application. The voltage gain of this phase inverter from the grid of V_1 to the two grids of the succeeding speech stage is slightly less than twice the actual gain of V_1 .

V_1 and V_2 need not be biased from the same cathode resistor; they may each have a separate cathode resistor (bypassed or not by-passed, as desired) and degenerative feedback from the output of the amplifier may be fed back into the cathode of V_1 (but *not* into V_2).

The voltage which appears on the grid of V_2 arises from the unbalance in the output voltages delivered by the two phase-inverter tubes. Hence, the higher the gain of the tube at V_2 the less will be the difference between the voltages fed to the two output stage grids. In any case, if the gain of V_1 is above 15, the voltage appearing on the grid fed by V_2 will be at least 94 per cent of that appearing at the other grid.

The circuit shown at (B) of Figure 17 has a total voltage gain from the input grid of the 6SJ7 to the two grids of the push-pull speech stage of about 2300. This is ample gain to operate from a source such as a crystal microphone or pickup into the grids of a pair of 6A3's, 6V6's, or 6L6's. The 6SJ7 stage gives a gain of about 150, while the 6J5 gives a total gain of about 14, or about 7 for each output tube grid. This circuit is unique among cathode-follower phase-inverter circuits in that the full gain of the cathode follower tube (6J5) is obtained, although this gain is split, of course, between the two grid circuits of the following stage. Slight adjustments in the value of the 100,000-ohm resistor in the cathode circuit of the 6J5 will allow exactly equal and opposite voltages to be obtained on the grids of the succeeding stage.

Tube Considerations, Voltage Amplifiers The gain of a resistance-coupled triode is primarily a function of the amplification factor, because the plate load resistance can be made much higher than the plate resistance of the tube where voltage amplification rather than power output is desired. If the plate load resistance were infinite, and the tube were somehow supplied with plate voltage, the voltage gain would be equal to the amplification factor of the tube. If the plate load resistance were made equal to the plate resistance of the tube, the gain would be equal to the amplification factor divided by two. Usually the plate load resistor is made several times the plate resistance, and the voltage gain runs about 0.75 of the μ of the tube.

As it is difficult to build a triode with μ of more than 100, the voltage gain of a single triode in a resistance coupled amplifier is limited to approximately 75, and for many tubes is much less.

Resistance-coupled pentode amplifiers usually employ tubes designed for voltage amplification (as contrasted to power

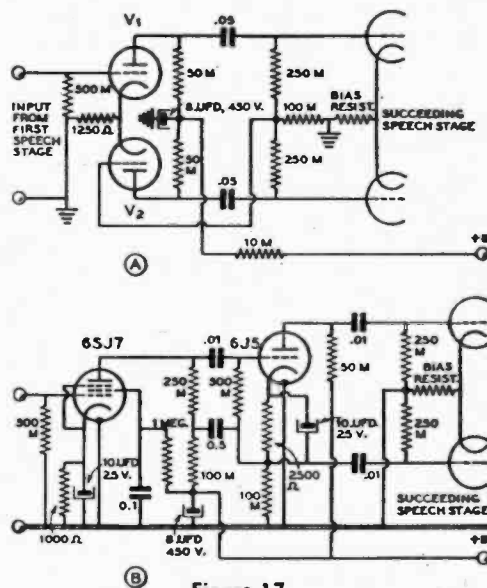

Figure 17. RECOMMENDED PHASE-INVERTER CIRCUITS.

(A) shows the "floating paraphrase" circuit which is the best for all ordinary applications. (B) shows an excellent complete front end for a speech amplifier which will deliver ample voltage output to drive any of the conventional power audio tubes when a conventional crystal or high-impedance dynamic microphone is used on the input. The circuit shown at (A) is quite flexible and is capable of considerable change to suit different circuit conditions. That shown at (B) should be used as is without change if its excellent operating characteristics are to be retained. Both circuits are fully described in the accompanying text.

pentodes) and the plate resistance of such tubes is very high, often over a megohm. The voltage gain of such a tube is equal to the plate load resistance in thousands of ohms times the transconductance in thousands of micromhos. However, it should be kept in mind that if the plate coupling resistor is made very high the plate voltage and current on the tube are thus limited to a very low value, and the transconductance under such conditions is much lower than the value listed in the tube tables for normal plate and screen voltages. However, by using optimum values of plate resistor, it is possible to obtain gains on the order of 300, which is considerably greater than can be obtained from an ordinary high- μ triode.

Tube Considerations, Power Amplifiers The plate load resistance giving maximum power output (without regard to voltage gain) from a given triode depends upon the amount of distortion which can be tolerated. If the maximum tolerable distortion limit is set anywhere between 3 and 10 per cent, it will be found that maximum output is obtained when the plate load resistance (assuming a resistive load) is equal to 2 or 3 times the dynamic plate resistance of the tube.

Optimum grid bias under these conditions will be found to be approximately $\frac{2}{3}$ the value of cut-off bias, the latter being determined by dividing the plate voltage by the μ of the tube. If the plate dissipation of the tube under these conditions does not equal or approach the maximum rated dissipation for the tube, then the output capabilities of the tube are not being fully realized. The plate voltage can be raised until the plate dissipation at $\frac{2}{3}$ cut-off bias equals the maximum recommended value for the tube, assuming that the maximum rated plate voltage is not exceeded first. The latter condition may easily occur when the amplification factor of the tube is high. For this reason the amplification factor and plate resistance of power output triodes are made low. There is no point in running high plate voltage on a power amplifier

when it is possible to design the tube to give full output at moderate plate voltage.

The maximum power output of a triode operated as recommended is approximately 20 per cent of the plate input for sine wave signal. If higher distortion can be tolerated, as in communications work, the efficiency at maximum output is approximately 25 per cent.

The plate load resistance which gives maximum power output from a pentode or beam power amplifier cannot be determined from a simple "rule of thumb." Whereas the load resistance must be considerably *higher* than the dynamic plate resistance of a triode for low distortion, the load resistance for a pentode or beam tetrode must be considerably *lower* than the plate resistance of the tube. The exact value of optimum load, however, must be evolved either by cut and try or by rather involved calculations. The same pertains to the bias, though in general the optimum Class A bias will be about the same or slightly lower than for a triode, expressed in terms of percentage of cut-off bias. The optimum values of bias and load resistance for a pentode or tetrode power audio stage are best taken from the manufacturer's data, the more pertinent of which is given in the tube data tables in this book.

The efficiency of a pentode or beam tetrode at maximum undistorted sine wave output is slightly higher than for a triode if only the plate input is considered, running about 30 per cent. However, if the tube draws much screen current, the overall efficiency will not be appreciably greater than that of a triode.

Push-pull beam tetrodes running class AB will give high output with moderate distortion, and are widely used in public address and communications work where audio powers on the order of 10 to 200 watts are required.

Inverse Feedback Inverse feedback, also called *negative feedback* or *degenerative feedback*, is a method of lowering the distortion, hum and noise generated in an audio stage at the expense of voltage gain. It also reduces the *effective* plate resistance of the stage and improves the frequency response. The reduction in distortion, noise, and effective plate resistance is proportional to the amount of feedback.

Basically, the application of inverse feedback to an audio system consists of taking a portion of the voltage developed at the output of a stage and feeding it back to the input of that or a preceding stage, 180 degrees out of phase with the input voltage. The loss in gain resulting from the incorporation of inverse feedback can be made up by adding an additional stage of voltage amplification at the front end of the amplifier, where distortion is very low anyhow because of the comparatively low magnitude of the signal at that point in the amplifier.

Inverse feedback systems are of two kinds, inverse *voltage* feedback, and inverse *current* feedback. In the former, the circuit is arranged so that the voltage fed back is proportional to the *voltage* developed across the load. This type of inverse feedback reduces the effective internal or "dynamic" plate resistance of the amplifier, and is the most commonly used type.

Negative *current* feedback also feeds an out-of-phase voltage back to the input, but the voltage is taken across a resistance in series with the output load, so that the voltage fed back is proportional to the *current* developed in the output load. An unbypassed cathode resistor in a single ended stage provides this type of feedback, which is satisfactory where the load impedance is constant regardless of amplitude or frequency. Because the latter condition obtains only in a few special applications, this type feedback is not so widely used as inverse voltage feedback.

As will be explained later, there is a limit to the amount of

inverse feedback which can be employed without encountering a tendency towards oscillation. The reduction in distortion and gain resulting from inverse feedback can be approximated quite closely by the following rule:

Determine the gain without feedback, and note the percentage of the output voltage which will be fed back, the latter being designated the *feedback factor*. Divide the *gain without feedback* by the *original gain times the feedback factor, plus 1*. Thus, if the original gain (without feedback) was 20 and the feedback factor is 0.20 (meaning that 20% of the output voltage is fed back), then the gain with feedback is

$$\frac{20}{20(0.2) + 1} \text{ or } 4.$$

Phase Shift It is apparent that unless the feedback voltage is between 90 and 270 degrees out of phase with the input voltage, the feedback will cause *regeneration* rather than *degeneration*. When employing a degenerative feedback circuit, care must be taken to see that the feedback is not regenerative rather than degenerative at very low and very high frequencies outside the desired frequency range, causing oscillation. For instance, a feedback amplifier may be designed to have very nearly 180 degrees phase shift (optimum) over the range 100 to 5,000 cycles, yet have less than 90 or more than 270 degrees phase shift at say 10 cycles or 50,000 cycles. The problem is to keep the gain sufficiently low at the frequencies where the feedback is regenerative that the amplifier does not oscillate.

In a single resistance-coupled stage, it is impossible to obtain phase shift in excess of 90 degrees, regardless of frequency or circuit constants.

In a two stage amplifier it is comparatively easy to keep the phase shift sufficiently low to permit a high degree of feedback without oscillation, but when three resistance-coupled stages are included in the feedback "loop," considerable care must be taken to avoid instability. In a multi-stage amplifier the tendency towards oscillation can be reduced by designing one stage with a pass band just sufficient for the intended application, and the remaining stage or stages to have as little attenuation as possible outside the pass band. This arrangement keeps the gain well down at all frequencies having appreciable phase shift.

When transformer coupling is employed within the feedback loop, the tendency towards oscillation is aggravated. The leakage reactance in a transformer, especially in a cheap one, causes considerable phase shift at the higher audio frequencies. Also, unless the transformer is designed for good bass response, there will be appreciable phase shift at the lower end of the audio range. For this reason it is difficult to employ a worthwhile amount of feedback around a loop containing more than two good or one mediocre transformer. Transformers having a turns ratio near unity will give the least trouble; those with a high step-up or step-down ratio will produce so much phase shift that the incorporation of negative feedback around even the one transformer is not always feasible.

Negative Feedback Circuits In Figure 18, a simple method of applying inverse feedback to an audio amplifier is shown. With the values of resistance as indicated, the negative feedback is approximately 10 per cent. This reduces the gain of the audio amplifier; however, it still has approximately twice the sensitivity of a typical triode amplifier with similar plate circuit characteristics. The plate circuit impedance of the 6L6 is greatly reduced, an advantage when working into a loudspeaker (because a loudspeaker is not a constant impedance device).

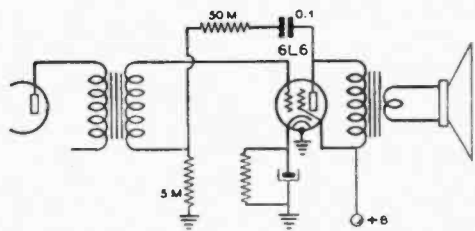

Figure 18.
INVERSE VOLTAGE FEEDBACK INCORPORATED IN A SINGLE STAGE BEAM POWER AMPLIFIER.

Inverse feedback can be applied in a somewhat different manner, as shown in Figure 19, for a two-stage amplifier. This method is particularly desirable, in that the tube driving the output stage does not have to deliver a high output voltage to offset the "bucking" effect of the feedback, as is the case where the feedback voltage is merely fed back from the plate to the grid circuit of the same stage.

The polarity of the secondary winding of the output transformer, in all cases where the feedback connection is made to the secondary, should be that which will produce degeneration and reduction in amplifier gain, rather than regeneration and howl or increase of gain.

The circuit of Figure 20 shows inverse feedback applied over three stages of amplification. These two systems are suitable for operation as speech amplifiers and modulators for grid-modulated radio-telephones, or low-power plate-modulated transmitters. The 100-ohm cathode resistor should be located as near as possible to the 6C5 tube cathode terminal in order to prevent undesirable pickup and feedback at frequencies other than those desired.

Because three stages, including two transformers, are included within the loop, some juggling of coupling and bypass capacitor values to suit the transformers and circuit layout employed probably will be required in order to permit a worthwhile amount of feedback to be obtained without oscillation. The transformers must be of good quality, having low leakage reactance.

Rectified Carrier Inverse Feedback It is possible to include a modulated r-f power amplifier stage within the feedback loop if certain precautions are taken, thus reducing the hum, noise, and modulation distortion generated by or within the modulated r-f stage itself. This type of feedback is employed in most broadcast transmitters, and also can be used to advantage in communications transmitters.

The method consists of rectifying a small amount of carrier signal in order to recover the audio envelope, and feeding this audio voltage back into an appropriate part of the speech

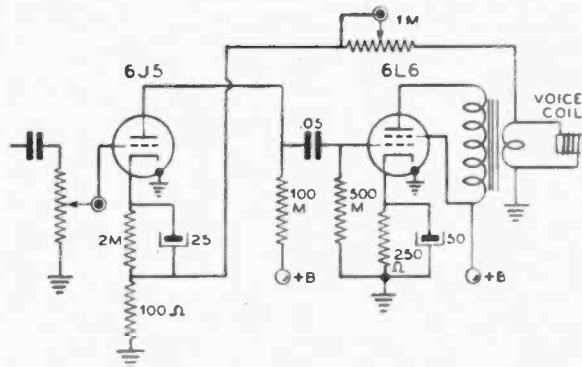

Figure 19.
INVERSE VOLTAGE FEEDBACK AROUND A TWO STAGE AMPLIFIER, WITH ADJUSTABLE FEEDBACK.

amplifier in the proper phase. Two inverse feedback rectifier circuits are shown in Figures 22 and 23.

Things which must be carefully avoided within the feedback loop are small values of interstage coupling capacitors, any sort of shunting capacitors such as a plate by-pass on a modulated stage, and large values of series resistance anywhere within the feedback loop. If there should arise any case of oscillation caused by too large a value of series resistor in the feedback circuit proper, this trouble can often be cured by shunting the series resistor with a very small value of mica capacitor—0.00004 μ fd. or so. However, in a case where it is impossible to eliminate oscillation in a circuit employing degenerative feedback, it is always possible to eliminate the difficulty by reducing the amount of feedback. In a circuit with a large amount of phase change with frequency, it may be necessary to reduce the feedback to an amount so small that it may as well be eliminated. This is the condition which usually arises when it is attempted to place degenerative feedback around a plate-modulated transmitter using Class B modulators. Degenerative feedback may be used satisfactorily from the rectified carrier back to the audio system in transmitters using Heising plate modulation, and suppressor or control-grid modulation. The system is especially suited to application in transmitters using grid-bias modulation, as it is easy to apply and reduces to a negligible value the appreciable distortion inherent in a Class C grid bias modulated stage.

Further data on the theory and application of degenerative feedback to transmitters and audio-amplifier circuits has been given in Chapter 4, Section 4-15.

Bass Suppression Most of the power represented by ordinary speech (particularly the male voice) lies below 1000 cycles. If all frequencies below 400 or 500 cycles

Figure 20.
40-WATT BEAM POWER AMPLIFIER WITH INVERSE FEEDBACK.

Unless high quality transformers are employed, excessive phase shift will prevent using more than a small amount of feedback without encountering oscillation.

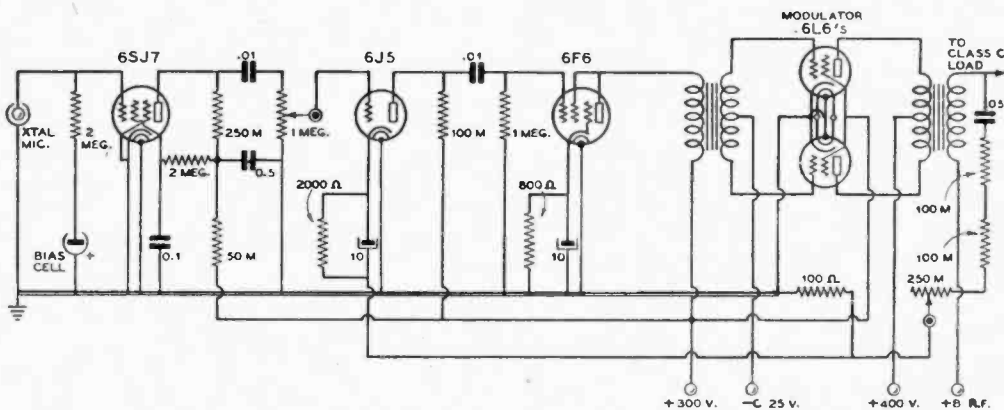

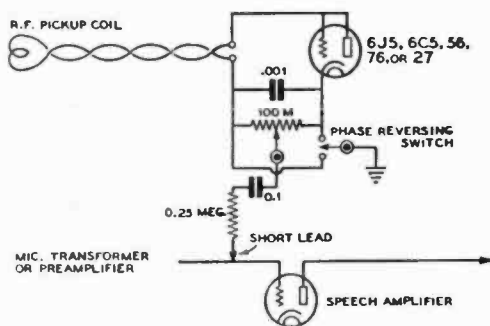

Figure 21.

DIODE CARRIER RECTIFIER PROVIDING INVERSE FEEDBACK OF AUDIO ENVELOPE VOLTAGE.

This method of inverse feedback reduces distortion and noise in both modulator and modulated stage. It is widely used in broadcast practice, but cannot be employed to full advantage in a transmitter using class B plate modulation with an inexpensive modulation transformer. The leakage reactance of the latter encourages undesirable oscillations, unless the feedback factor is low.

are eliminated or substantially attenuated, there is a considerable reduction in power with but insignificant reduction in intelligibility. This means that the speech level may be increased considerably without over-modulation or overload of the audio system, which is equivalent to a corresponding increase in transmitter power. Furthermore, audio transformers and modulation transformers may be much smaller for a given audio power in watts, because the size of a transformer for a given power depends primarily upon the lowest frequency to be transmitted.

When a moderate amount of bass suppression is employed, the speech will not only be highly intelligible, but will appear to be of "good quality." However, careful observation and comparison with the speaker's actual voice will reveal that the transmitted speech is not "full" and "natural," two important considerations in broadcast work which are relatively unimportant in communications work.

As pointed out above, bass suppression permits a higher percentage modulation at the voice frequencies providing intelligibility, which is equivalent to a substantial increase in power. It is not necessary to suppress the bass frequencies completely, but only to attenuate them until, as the audio gain is increased, over-modulation first occurs at the voice frequencies that afford intelligibility, rather than at the power-consuming bass frequencies.

The simplest and probably the most practicable methods of bass suppression are simply to skimp on the size of the interstage coupling capacitors or cathode bypass capacitors in a resistance coupled amplifier, choosing values which cause the response to start to droop at about 600 cycles.

Predetermining the frequency characteristic by calculation of the cathode bypass capacitor is a rather complicated procedure, as the tube and other circuit parameters enter the picture. However, it is a simple matter to determine what value of interstage coupling capacitor is required to start a bass "droop" at any particular desired frequency. It is done as follows:

Make the grid coupling resistor at least twice the value of the associated plate coupling resistor. Then choose a value of coupling capacitor which has a reactance at 600 cycles which is equal to the resistance of the grid coupling resistor. (Refer to the reactance-frequency chart in Chapter 15.) If this procedure is applied to two cascaded resistance-coupled stages, an attenuation curve will be obtained which is about optimum, the response being down approximately 10 db at 400 cycles, and 20 db at 250 cycles. If desired, the knee of the response curve may be moved up or down in frequency by proper choice

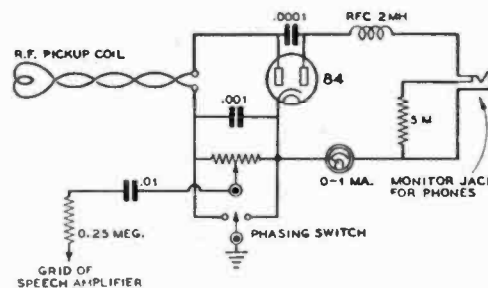

Figure 22.

CARRIER RECTIFIER CIRCUIT PROVIDING BOTH INVERSE FEEDBACK VOLTAGE AND MONITORING SIGNAL.

of coupling capacitor, and the sharpness of the cut off may be controlled by choice of the number of "bass suppressed" stages.

Inverse feedback should not be used around a bass suppressed stage, as the feedback will tend to "iron out" the frequency response by partially restoring the bass.

7-4 Speech Clipping

A characteristic of speech waveforms is the presence of frequently recurring high-intensity peaks of very short duration. These peaks will cause overmodulation if the "average" level of modulation on loud syllables exceeds approximately 30 per cent. Careful checking into the nature of speech sounds has revealed that these high-intensity peaks are due primarily to the vowel sounds. Further research has revealed that the vowel sounds add little to intelligibility, the major contribution to intelligibility coming from the consonant sounds such as *v, b, k, s, t, and l*. Measurements have shown that the power contained in these consonant sounds may be down 30 db or more from the energy in the vowel sounds in the same speech passage. Obviously, then, if we can increase the relative energy content of the consonant sounds with respect to the vowel sounds it will be possible to understand a signal modulated with such a waveform in the presence of a much higher level of background noise and interference. Experiment has shown that it is possible to accomplish this desirable result simply by cutting off or *clipping* the high-intensity peaks and thus building up in a relative manner the effective level of the weaker sounds.

Such clipping theoretically can be accomplished simply by increasing the gain of the speech amplifier until the average level of modulation on loud syllables approaches 90 per cent. This is equivalent to increasing the speech power of the consonant sounds by about 10 times or, conversely, we can say that 10 db of clipping has been applied to the voice wave. However, the clipping when accomplished in this manner will produce *higher order sidebands known as "splatter"*, and the transmitted signal would occupy a relatively tremendous slice of spectrum. So another method of accomplishing the desirable effects of clipping must be employed.

A considerable reduction in the amount of splatter caused by a moderate increase in the gain of the speech amplifier can be obtained by polarizing the signal from the speech amplifier to the transmitter such that the high-intensity peaks occur on *upward* or positive modulation. Overloading on positive modulation peaks produces far less splatter than the negative-peak clipping which occurs with overloading on the negative peaks of modulation. This aspect of the problem has been discussed in more detail in the section on *Speech Waveform Dissymmetry* earlier in this chapter. The effect of feeding the proper speech polarity from the speech amplifier to the modulator is shown in Figure 23.

A much more desirable and effective method of obtaining

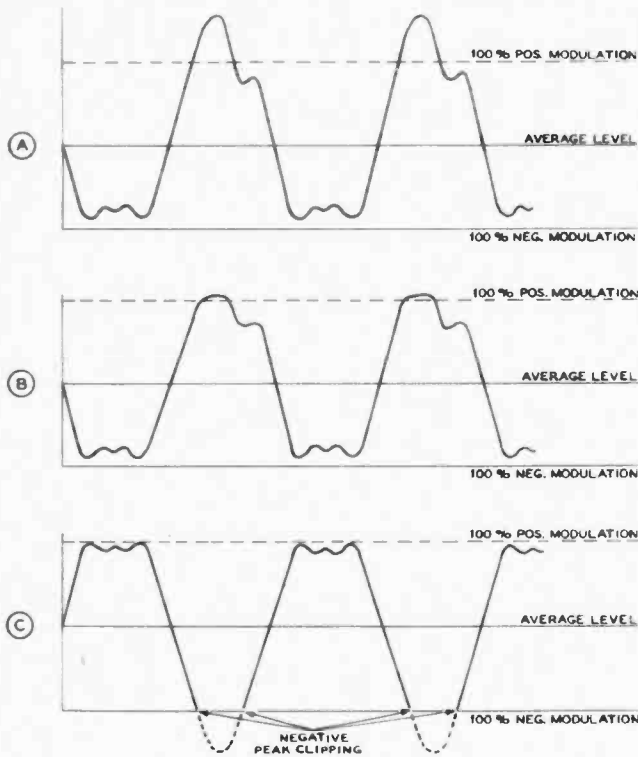

Figure 23.

SPEECH-WAVEFORM MODULATION.

Showing the effect of using the proper polarity of a speech wave for modulating a transmitter. (A) shows the effect of proper speech polarity on a transmitter having an upward modulation capability of greater than 100 per cent. (B) shows the effect of using proper speech polarity on a transmitter having an upward modulation capability of only 100 per cent. Both these conditions will give a clean signal without objectionable splatter. (C) shows the effect of the use of improper speech polarity. This condition will cause serious splatter due to negative-peak clipping in the modulated-amplifier stage.

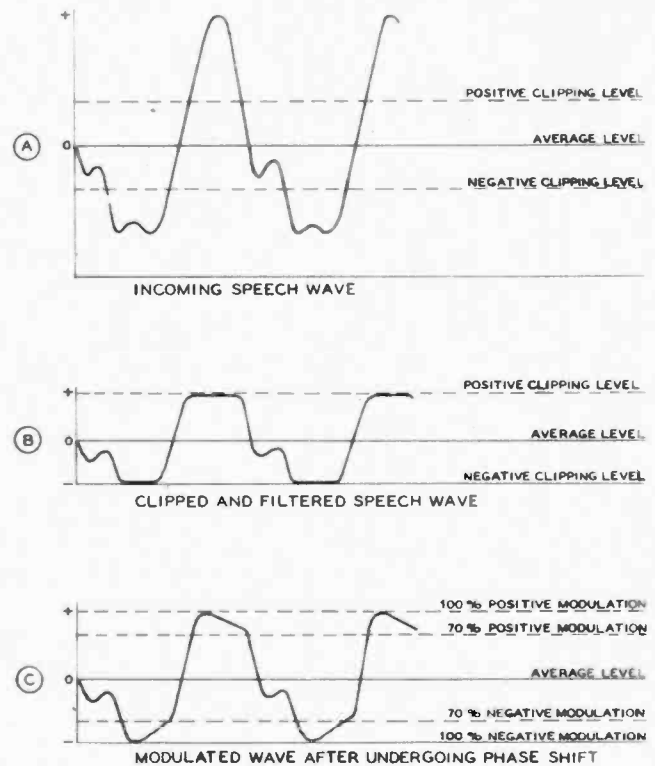

Figure 24.

ACTION OF A CLIPPER-FILTER ON A SPEECH WAVE.

The drawing (A) shows the incoming speech wave before it reaches the clipper stage. (B) shows the output of the clipper-filter, illustrating the manner in which the peaks are clipped and then the sharp edges of the clipped wave removed by the filter. (C) shows the effect of phase shift in the stages following the clipper-filter. (C) also shows the manner in which the transmitter may be adjusted for 100 per cent modulation on the "canted" peaks of the wave, the sloping top of the wave reaching about 70 per cent modulation.

speech clipping is actually to employ a clipper circuit in the earlier stages of the speech amplifier, and then to filter out the objectionable distortion components by means of a sharp low-pass filter having a cut-off frequency of approximately 3000 cycles. Tests on *clipper-filter* speech systems have shown that 6 db of clipping on voice is just noticeable, 12 db of clipping is quite acceptable, and values of clipping from 20 to 25 db are tolerable under such conditions that a high degree of clipping is necessary to get through heavy QRM or QRN. A signal with 12 db of clipping doesn't sound quite "natural" but it is not unpleasant to listen to and is much more readable than an unclipped signal in the presence of strong interference.

The use of a clipper-filter in the speech amplifier, to be completely effective, requires that phase shift between the clipper-filter stage and the final modulated amplifier be kept to a minimum. However, if there is phase shift after the clipper-filter the system does not completely break down. The presence of phase shift merely requires that the audio gain following the clipper-filter be reduced to the point where the "cant" applied to the clipped speech waves still cannot cause overmodulation. This effect is illustrated in Figure 24. The manner in which a clipped and filtered wave of three different frequencies will be affected by a constant amount of delay (phase shift) in the audio system following the clipper-filter is shown in Figure 25. Note that a 3000-cycle wave, regardless of the amount of clipping, comes through the clipper-filter and the succeeding audio system substantially as a sine wave of the same amplitude as the clipping level. However, as the frequency of the audio signal is decreased, the signals leaving the clipper-filter approach

a square wave in appearance and the effect of phase shift in the audio channel becomes more serious. Note that the "cant" appearing on the tops of the square waves leaving the clipper-filter centers about the clipping level. Hence, as the frequency being passed through the system is lowered, the amount by which the peak of the "canted" wave exceeds the clipping level is increased.

In a normal transmitter having a moderate amount of phase shift the cant applied to the tops of the waves will cause overmodulation on frequencies below those for which the gain following the clipper-filter has been adjusted unless remedial steps have been taken. The following steps are advised:

- (1) Introduce bass *suppression* into the speech amplifier *ahead* of the clipper-filter.
- (2) *Improve* the low-frequency response characteristic insofar as it is possible in the stages *following* the clipper-filter. Feeding the plate current to the final amplifier through a choke rather than through the secondary of the modulation transformer will usually help materially.

Even with the normal amount of improvement which can be attained through the steps mentioned above there will still be an amount of wave cant which must be compensated in some manner. This compensation can be done in either of two ways. The first and simplest way is as follows:

- (1) Adjust the speech gain *ahead* of the clipper-filter until with normal talking into the microphone the distortion being introduced by the clipper-filter circuit is quite apparent but not objectionable. This amount of distortion will

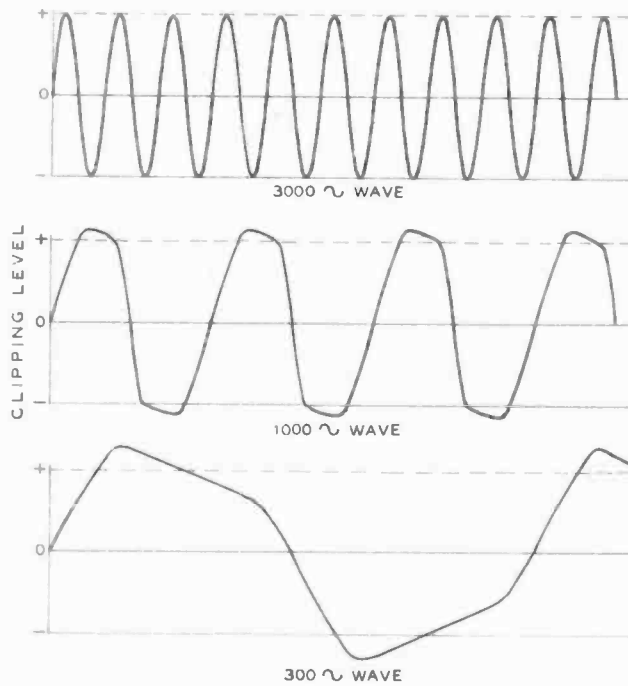

Figure 25.

ILLUSTRATING THE EFFECT OF PHASE SHIFT ON CLIPPED AND FILTERED WAVES OF DIFFERENT FREQUENCY.

Sketch (A) shows the effect of a clipper and a filter having a cutoff of about 3500 cycles on a wave of 3000 cycles. Note that no harmonics are present in the wave so that phase shift following the clipper-filter will have no significant effect on the shape of the wave. (B) and (C) show the effect of phase shift on waves well below the cutoff frequency of the filter. Note that the "cant" placed upon the top of the wave causes the peak value to rise higher and higher above the clipping level as the frequency is lowered. It is for this reason that bass suppression before the clipper stage is desirable. Improved low-frequency response following the clipper-filter will reduce the phase shift and therefore the canting of the wave at the lower voice frequencies.

be apparent to the normal listener when 10 to 15 db of clipping is taking place.

- (2) Tune a selective communications receiver about 15 kc. to one side or the other of the frequency being transmitted. Use a short antenna or no antenna at all on the receiver so that the transmitter is not blocking the receiver.
- (3) Again with normal talking into the microphone adjust the gain following the clipper-filter to the point where sideband splatter is being heard, and then slightly back off the gain after the clipper-filter until the splatter disappears.

If the phase shift in the transmitter or modulator is not excessive the adjustment procedure given above will allow a clean signal to be radiated regardless of any reasonable voice level being fed into the microphone.

If a cathode-ray oscilloscope is available the modulated envelope of the transmitter should be checked with 30 to 70 cycle saw-tooth waves on the horizontal axis. If the upper half of the envelope appears in general the same as the drawing of Figure 24C, all is well and phase-shift is not excessive. However, if much more slope appears on the tops of the waves than is illustrated in this figure, it will be well to apply the second step in compensation in order to insure that sideband splatter cannot take place and to afford a still higher average percentage of modulation. This second step consists of the addition of a high-level "splatter suppressor" such as is illustrated in Figure 26.

The use of a high-level splatter suppressor after a clipper-filter system will afford the result shown in Figure 27 since

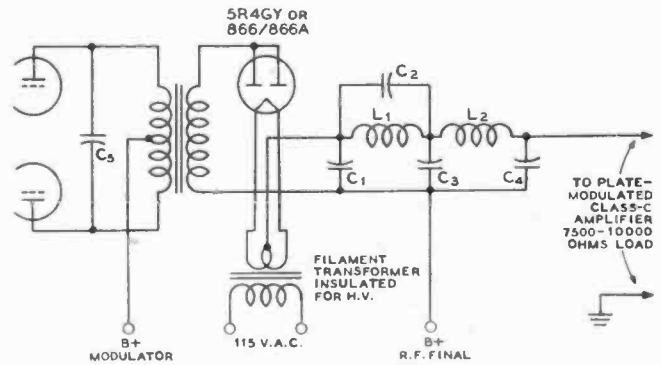

Figure 26.

HIGH-LEVEL SPLATTER SUPPRESSOR.

This circuit is effective in reducing splatter caused by negative-peak clipping in the modulated amplifier stage. The use of a two-section filter as shown is recommended, although either a single m-derived or a constant-k section may be used for greater economy. The values for the particular components are not critical for this application: C_1 , C_2 , C_3 , and C_4 can all be 0.002- μ fd. mica capacitors rated at 2500 volts for operation with 2000 volts on the plate of the final stage. C_2 should be 0.001 μ fd. and can be 1250-volt rating. The chokes L_1 and L_2 should be about 0.3 henry and should preferably be air-core coils, although iron-core may be used if available.

such a device will not permit the negative-peak clipping which the wave cant caused by audio-system phase shift can produce. The high-level splatter suppressor operates by virtue of the fact that it will not permit the plate voltage on the modulated amplifier to go completely to zero regardless of the incoming signal amplitude. Hence negative-peak clipping with its attendant splatter cannot take place. Such a device can, of course, also be used in a transmitter which does not incorporate a clipper-filter system. However, the full increase in average modulation level without serious distortion, afforded by the clipper-filter system, will not be obtained.

A word of caution should be noted at this time in the case of tetrode final modulated amplifier stages which afford screen voltage modulation by virtue of a tap or a separate winding on the modulation transformer such as is shown in Figure 8C of this chapter. If such a system of modulation is in use, the high-level splatter suppressor shown in Figure 26 will not operate satisfactorily since negative-peak clipping in the stage can take place when the screen voltage goes too low. There are several remedies which can be employed:

- (1) Introduce an additional high-level splatter suppressor of the type shown in Figure 26 in the screen feed circuit of the tube—on the modulated-voltage side of the screen winding of the modulation transformer.
- (2) Use a different screen-voltage modulation circuit. The circuits shown in Figures 8A, 8B, and 8D will not give this difficulty.

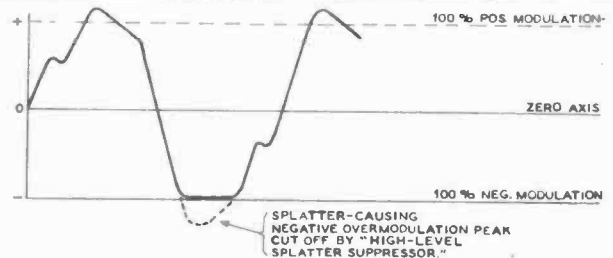

Figure 27.

ACTION OF HIGH-LEVEL SPLATTER SUPPRESSOR.

A high-level splatter suppressor may be used in a transmitter without a clipper-filter to reduce negative-peak clipping, or such a unit may be used following a clipper-filter to allow a higher average modulation level by eliminating the negative-peak clipping which the wave-cant caused by phase shift might produce.

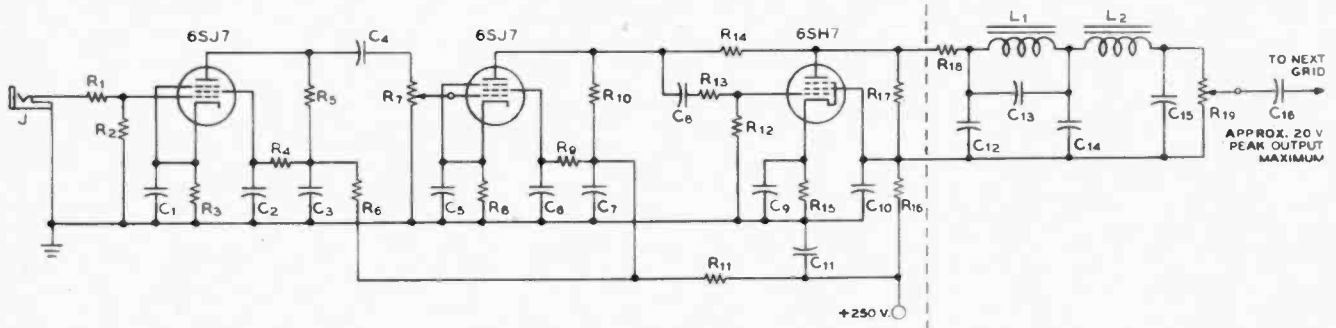

Figure 28.

CLIPPER-FILTER CIRCUIT USING AMPLIFIER-CLIPPER STAGE.

- | | | | |
|---|--|--|--|
| C ₁ —25- μ fd. 25-volt elect. | C ₁₀ —8- μ fd. 450-volt elect. | R ₃ —1800-ohms 1/2 watt | R ₁₂ , R ₁₃ , R ₁₁ —1 meg. 1/2 watt |
| C ₂ —0.5- μ fd. 400-volt paper | C ₁₁ —0.003- μ fd. mica by-pass | R ₄ —2.2 meg. 1/2 watt | R ₁₄ —470 ohms 1 watt |
| C ₃ —1.0- μ fd. 400-volt paper | C ₁₂ —200- μ fd. mica | R ₅ —470K 1/2 watt | R ₁₅ —22K 2 watts |
| C ₄ —0.003- μ fd. mica | C ₁₃ —175- μ fd. mica | R ₆ —47K 1 watt | R ₁₆ —15K 2 watts |
| C ₅ —25- μ fd. 25-volt elect. | C ₁₄ —500- μ fd. mica | R ₇ —1-megohm potentiometer | R ₁₇ —100K 1/2 watt |
| C ₆ —0.5- μ fd. 400-volt paper | C ₁₅ —330- μ fd. mica | R ₈ —1000 ohms 1/2 watt | R ₁₈ —100,000-ohm pot. |
| C ₇ —8- μ fd. 450-volt elect. | C ₁₆ —0.1- μ fd. 400-volt paper | R ₉ —1 meg. 1/2 watt | L ₁ , L ₂ —Stancor C-1080 chokes |
| C ₈ —0.003- μ fd. mica | R ₁ —47K 1/2 watt | R ₁₀ —220K 1/2 watt | J—Microphone jack |
| C ₉ —25- μ fd. 25-volt elect. | R ₂ —1 meg. 1/2 watt | R ₁₁ —22K 2 watt | |

(3) Do not use a "high-level splatter suppressor" and reduce the gain following the clipper-filter system until a pattern such as shown in Figure 24C is obtained, checking for splatter at the same time on a communications receiver by the method given in three steps in a preceding paragraph.

Clipper Circuits There are three satisfactory methods whereby clipping may be obtained in the low-level stages of the speech amplifier. These methods involve the use of a series-clipper diode system, a shunt-clipper diode, or an amplifier-clipper. In order for a clipper system to introduce the least amount of distortion into the wave being passed, it should be quite linear up to the point where clipping takes place. The amplifier-clipper system with degenerative feedback from the plate of the clipper back to the preceding stage has proven to be the most linear and distortion-free of the various methods used. Next in desirability from the standpoint of effectiveness and simplicity is the shunt-clipper diode system. The series-clipper system is the most complicated and least stable of the three systems but has the advantage that the sharpest clipping is obtained.

Figure 28 shows a front end for a speech amplifier utilizing an amplifier-clipper and Figure 29 shows a speech amplifier front end using a shunt-clipper arrangement. In both cases a

filter system has been shown following the clipper stage. Recommended component values have also been given in both circuits.

Filter Circuits for Clippers

Recommended filters have been shown in the circuits of both Figure 28 and Figure 29. A two-section filter has been used with the circuit of Figure 28 and a single-section filter is shown with the circuit of Figure 29. The filters for the two circuits may be interchanged since both are designed for a characteristic impedance of 100,000 ohms and a cutoff frequency of about 3500 cycles. Should it be desired to employ a filter different from the ones diagrammed, a low-pass filter of any desired characteristic may be designed with the aid of Figure 39 in Chapter 2.

Inspection of the characteristic filter curves shown in Figure 39 in Chapter 2 will show the attenuation/frequency characteristic of the *m*-derived (*m* equal 0.6) and constant-*k* types of filters. The *m*-derived filter gives a much more rapid attenuation up to a certain frequency past the cutoff point than does the constant-*k* type of filter. However, after this point of maximum attenuation has been passed in the case of the *m*-derived filter the attenuation begins to decrease. But in the case of the constant-*k* type of filter the attenuation decreases indefinitely. Therefore a combination of an *m*-derived filter section fol-

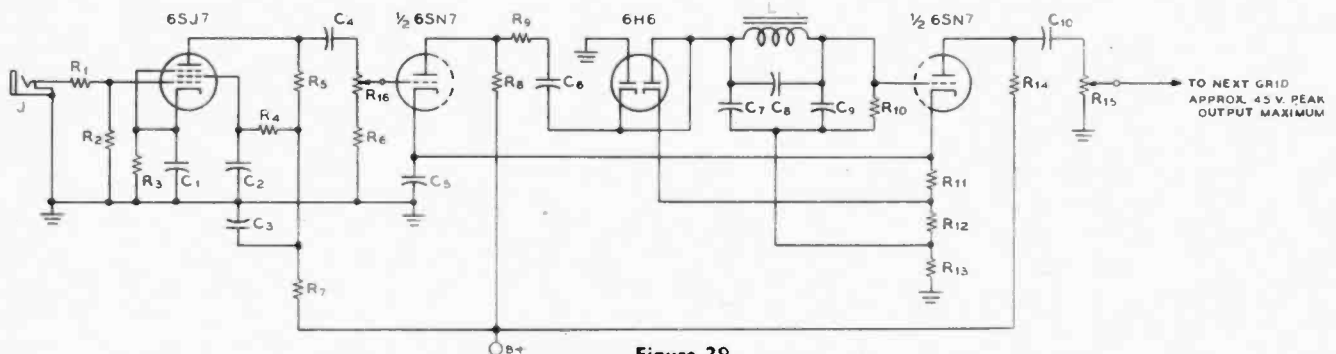

Figure 29.

CLIPPER-FILTER CIRCUIT USING DOUBLE DIODE.

- | | | | |
|--|---|------------------------------------|---|
| C ₁ —25- μ fd. 25-volt elect. | C ₇ —175- μ fd. mica | R ₇ —470K 1/2 watt | R ₁₂ —620 ohms 1/2 watt |
| C ₂ —0.5- μ fd. 400-volt paper | C ₈ —200- μ fd. mica | R ₈ —4n error; delete | R ₁₃ —620 ohms 1/2 watt |
| C ₃ —8- μ fd. 450-volt elect. | C ₉ —0.1- μ fd. 400-volt paper | R ₉ —47K 1/2 watt | R ₁₄ —47K 1 watt |
| C ₄ —0.003- μ fd. mica | R ₁ —47K 1/2 watt | R ₁₀ —100K 1 watt | R ₁₅ , R ₁₆ —500,000-ohm pot. |
| C ₅ —25- μ fd. 25-volt elect. | R ₂ —1 meg. 1/2 watt | R ₁₁ —100K 1/2 watt | L—Stancor C-1080 choke |
| C ₆ —0.01- μ fd. 400-volt paper | R ₃ —1800 ohms 1/2 watt | R ₁₂ —100K 1/2 watt | (approx. 4 hy. at no d.-c.) |
| C ₇ —200- μ fd. mica | R ₄ —2.2 meg. 1/2 watt | R ₁₃ —330 ohms 1/2 watt | J—Microphone jack |

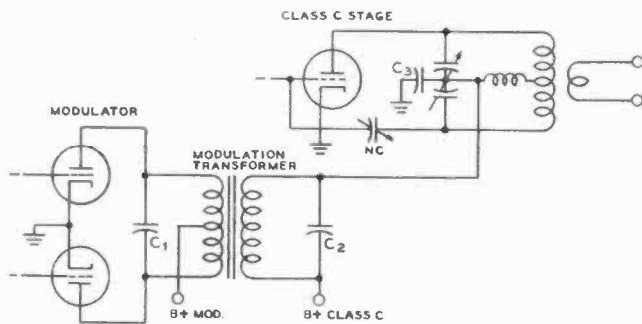

Figure 30.

"BUILDING-OUT" THE MODULATION TRANSFORMER.

This expedient utilizes the leakage reactance of the modulation transformer in conjunction with the capacitors shown to make up a single-section low-pass filter. In order to determine exact values for C_1 and C_2 plus C_3 , it is necessary to use a measurement setup such as is shown in Figure 31. However, experiment has shown in the case of a number of commercially available modulation transformers that a value for C_1 of 0.002- μ f. and C_2 plus C_3 of 0.004 μ f. will give satisfactory results.

lowed by a constant- k section will give a more rapid overall rate of attenuation than two sections of either type of filter. This is the type of filter that has been employed in the circuit of Figure 28.

High-Level Filters

Even though we may have cut off all frequencies above 3000 or 3500 cycles through the use of a filter system such as is shown in the circuit of Figure 28, higher frequencies may again be introduced into the modulated wave by distortion in stages following the speech amplifier. Harmonics of the incoming audio frequencies may be generated in the driver stage for the modulator; they may be generated in the plate circuit of the modulator; or they may be generated by non-linearity in the modulated amplifier itself.

Regardless of the point in the system following the speech amplifier where the high audio frequencies may be generated, these frequencies can still cause a broad signal to be transmitted even though all frequencies above 3000 or 3500 cycles have been cut off in the speech amplifier. The effects of distortion in the audio system following the speech amplifier can be eliminated quite effectively through the use of a *post-modulator* filter. Such a filter must be used between the modulator plate circuit and the r-f amplifier which is being modulated. This filter may take three general forms in a normal case of a Class C amplifier plate modulated by a Class B modulator. The best method is to use a "high-level splatter suppressor" of the type shown in Figure 26 in which a filter network follows the rectifier tube. The next best arrangement is to use a high-level filter of the type shown without the negative-peak rectifier tube. All the constants for a Class C amplifier load of 7500 to 10,000 ohms can be the same as for the filter shown in Figure 26. The third method, which will give excellent results in some cases and poor results in others, dependent upon the characteristics of the modulation transformer, is to "build out" the modulation transformer into a filter section. This is accomplished as shown in Figure 30 by placing mica capacitors of the correct value across the primary and secondary of the modulation transformer. The proper values for the capacitors C_1 and C_2 must, in the ideal case, be determined by trial and error. Experiment with a number of modulators has shown, however, that if a 0.002 μ f. capacitor is used for C_1 , and if the sum of C_2 and C_3 is made 0.004 μ f. (0.002 μ f. for C_2 and 0.002 for C_3) the ideal condition of gradual cutoff above 3000 cycles will be approached in most cases with the "multiple-match" type of modulation transformer.

If it is desired to determine the optimum values of the

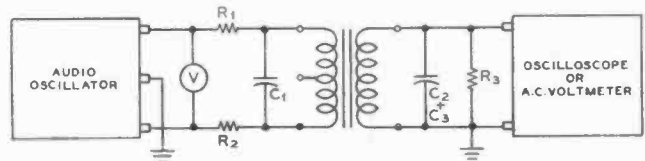

Figure 31.

TEST SETUP FOR BUILDING-OUT MODULATION TRANSFORMER.

Through the use of a test setup such as is shown and the method described in the text it is possible to determine the correct values for a specified filter characteristic in the built-out modulation transformer.

capacitors across the transformer this can be determined in several ways, all of which require the use of a calibrated audio oscillator such as is shown in Chapter 31. One way is diagrammed in Figure 31. The series resistors R_1 and R_2 should each be equal to $1/2$ the value of the recommended plate-to-plate load resistance for the Class B modulator tubes. Resistor R_3 should be equal to the value of load resistance which the Class C modulated stage will present to the modulator. The meter V can be any type of a-c voltmeter. The indicating instrument on the secondary of the transformer can be either a cathode-ray oscilloscope or a high-impedance a-c voltmeter of the vacuum-tube or rectifier type.

With a set-up as shown in Figure 31 a plot of output voltage against frequency is made, at all times keeping the voltage across V constant, using various values of capacitance for C_1 and C_2 plus C_3 . When the proper values of capacitance have been determined which give substantially constant output up to about 3000 or 3500 cycles and decreasing output at all frequencies above, high-voltage mica capacitors can be substituted if receiving types were used in the tests and the transformer connected to the modulator and Class C amplifier.

With the transformer reconnected in the transmitter a check of the modulated-wave output of the transmitter should be made using an audio oscillator as signal generator and an oscilloscope coupled to the transmitter output. With an input signal amplitude fed to the speech amplifier of such amplitude that limiting does not take place, a substantially clean sine wave should be obtained on the carrier of the transmitter at all input frequencies up to the cutoff frequency of the filter system in the speech amplifier and of the filter which includes the modulation transformer. Above these cutoff frequencies very little modulation of the carrier wave should be obtained. To obtain a check on the effectiveness of the "built out" modulation transformer, the capacitors across the primary and secondary should be removed for the test. In most cases a marked deterioration in the waveform output of the modulator will be noticed with frequencies in the voice range from 500 to 1500 cycles being fed into the speech amplifier.

A filter system similar to that shown in Figure 26 may be used between the modulator and the grid circuit in a grid-modulated transmitter. Lower-voltage capacitors and low-current chokes may of course be employed.

Modulated Amplifier Distortion

The systems described in the preceding paragraphs will have no effect in reducing a broad signal caused by non-linearity in the modulated amplifier. Even though the modulating waveform impressed upon the modulated stage may be distortion free, if the modulated amplifier is non-linear distortion will be generated in the amplifier. The only way in which this type of distortion may be corrected is by making the modulated amplifier more linear. Degenerative feedback which includes the modulated amplifier in the loop will help in this regard.

Plenty of grid excitation and high grid bias will go a long

way toward making a plate-modulated Class C amplifier linear. If this still does not give adequate linearity, the preceding buffer stage may be modulated 50 per cent or so at the same time and in the same phase as the final amplifier. The use of a grid leak to obtain the majority of the bias for a Class C stage will improve its linearity.

The linearity of a grid-bias modulated r-f amplifier can be improved, after proper adjustments of excitation, grid bias, and antenna coupling have been made by modulating the stage which excites the grid-modulated amplifier. The preceding driver stage may be grid-bias modulated or it may be plate modulated. Modulation of the driver stage should be in the same phase as that of the final modulated amplifier. A modulator unit for simultaneous grid-bias modulation of the final stage and the preceding stage is described in Chapter 24.

7-5 Transmitter Keying

The carrier from a c-w telegraph transmitter must be broken into dots and dashes for the transmission of code characters. The carrier signal is of a constant amplitude while the key is closed, and is entirely removed when the key is open. When code characters are being transmitted, the carrier may be considered as being modulated by the keying. If the change from the no-output condition to full-output, or vice versa, occurs too rapidly, the rectangular pulses which form the keying characters contain high-frequency components which take up a wide frequency band as sidebands and are heard as clicks.

The two general methods of keying a c-w transmitter are those which control the excitation, and those which control the plate voltage which is applied to the final amplifier. *Excitation keying* can be of several forms, such as crystal-oscillator keying, buffer-stage keying, or blocked-grid keying. In this arrangement, plate voltage is applied to the final amplifier at all times.

Key-Click Elimination Key-click elimination is accomplished by preventing a too-rapid make-and-break of power to the antenna circuit, rounding off the keying characters so as to limit the sidebands to a value which does not cause interference to adjacent channels. Too much lag will prevent fast keying, but fortunately key clicks can be practically eliminated without limiting the speed of manual (hand) keying. Some circuits which eliminate key clicks introduce too much time-lag and thereby add *tails* to the dots. These tails may cause the signals to be difficult to copy at high speeds.

Click Filters Eliminating key clicks by some of the key-click filter circuits illustrated in the following text is not certain with every individual transmitter. The constants in the time-lag and spark-producing circuits depend upon the individual characteristics of the transmitter, such as the type of filter, power input, and various circuit impedances. All keying systems have one or more disadvantages, so that no particular method can be recommended as an ideal one. An intelligent choice can be made by the reader for his particular transmitter requirements by carefully analyzing the various keying circuits.

Sparking Contacts Just as any electrical circuit producing sparks will cause interference to *nearby* receivers unless precautions are taken to prevent it, so will a sparking key or relay cause interference unless measures are taken to prevent it. The interference produced will have no correlation with the frequency upon which the transmitter is operating; the clicks produced are not keying sidebands, but rather are due to the sparking contacts and their associated wiring acting as a crude form of a periodic spark transmitter.

Clicks due to key sparks can be minimized by limiting the amount of power handled by the key, and then putting an r-f bypass capacitor of 0.002 μ f. or so directly across the key terminals (on the key, not at the transmitter), and in stubborn cases a couple of r-f chokes in series with the key leads right at the key terminals.

A sparking relay, which usually will be called upon to handle considerably more power, can be prevented from causing trouble by housing it in a grounded metal can and bypassing to the can all leads to the relay at the point where they enter the can. If this does not suffice, inserting r-f chokes in series with the leads, right at the relay, often will prove satisfactory.

Clicks due to sparking contacts should not be confused with those due to keying sidebands. The former may be heard over most of the radio spectrum if not suppressed, but only for a short distance. Clicks due to keying sidebands are actually radiated by the transmitting antenna, and may be heard for a great distance, but under the worst conditions only over a band of frequencies a few per cent either side of the carrier frequency.

Primary Keying One simple form of clickless keying which is satisfactory for certain applications under some conditions is *primary keying*. The key or keying relay is placed in the primary winding of the a-c plate transformer feeding the final amplifier (and in some cases one or more of the preceding stages).

The inherent lag in the plate supply filter will "round off" the keying to the point where keying sidebands are insignificant. In fact, if a heavily filtered 60-cycle single-phase supply is used, there may be too much lag for anything but slow hand keying, and code characters will have objectionable "tails". However, if the plate supply filter is engineered as a multiple section low-pass filter working into its characteristic impedance and designed for about 40-cycle cut-off, it is possible to obtain nearly pure direct current and yet key through the filter cleanly at high speed.

When precautions are taken against spark radiation, this type of keying is an almost sure cure for clicks. The disadvantages are (1) a heavy relay is required, in order to avoid sticking contacts, and (2) the special filter requirements in order to avoid keying tails.

Grid-Controlled Rectifiers The relay troubles encountered with primary keying when high power is used may be avoided by the use of grid-controlled rectifiers. The arrangement is somewhat more expensive, as the grid-controlled rectifier tubes cost considerably more than straight rectifiers of the same power and voltage rating. Also,

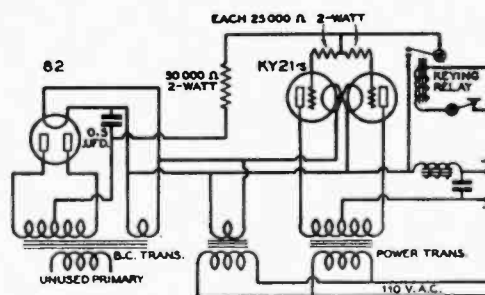

Figure 32.

TYPICAL GRID-CONTROLLED RECTIFIER KEYING.

A small receiver-type power transformer is used for the bias supply. It must be insulated from ground by mounting away from the grounded chassis of the power supply. The keying relay should have the contacts well isolated from the key circuit, in order to afford protection to the operator. One side of the key should be grounded.

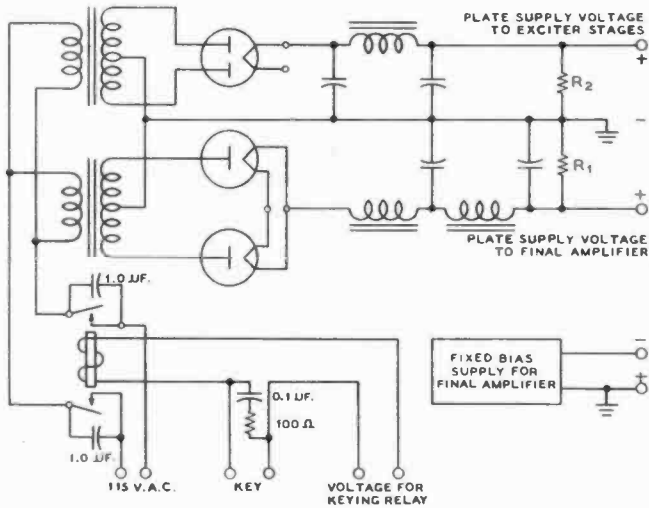

Figure 33.

IMPROVED PRIMARY-KEYING CIRCUIT.

The characteristics of this circuit are described in detail in the text. If the circuit system has been properly applied it is possible to obtain excellent primary keying without objectionable keying lag.

auxiliary equipment is required for providing an isolated source of grid bias for the rectifiers.

The filter considerations are the same as for primary keying, as in each case the supply voltage is interrupted *ahead* of the power supply filter.

A typical circuit, applicable to a 1 kilowatt transmitter, is illustrated in Figure 32. The bias transformer must have a filament winding of the same filament voltage used on the rectifiers. The whole transformer is at the power supply voltage above ground, and must be well insulated from the metal chassis and other grounded portions of the circuit.

The keying relay must likewise be insulated for the plate voltage; that is, there must be adequate spacing between the relay solenoid and the contacts, because the former should be at ground potential in order to provide protection to the operator from the high voltage.

Improved Primary-Keying Circuit

Figure 33 illustrates an improved type of primary-keying arrangement which reduces greatly the keying lag which

accompanies the usual primary-keying circuits. Upon first glance the circuit appears to be quite conventional. However, the difference lies in the fact that the plate supply for the exciter is keyed at the same time as the final plate supply, the final amplifier is biased by means of a power supply which provides sufficient voltage to bias the final amplifier tubes past cutoff at the operating plate voltage used, and a very high value of bleeder resistance is employed on the high-voltage plate supply. Adequate filter should be used on the high-voltage plate supply to insure that the transmitted signal will be adequately pure. However, the filter on the *exciter* plate supply should be reduced to the point where high-speed keying without tails is obtained. The resistor R_1 in the circuit diagram should be approximately one megohm for each 1000 volts of plate voltage. This means that this resistor can very well be the multiplier resistor associated with the high-voltage d-c voltmeter. Such a voltmeter is required anyway with all transmitters operating at more than 900 watts input. Resistor R_2 can be a conventional bleeder resistor of 15,000 to 50,000 ohms depending upon the voltage.

A word should be mentioned in regard to safety when using only a very high value of bleeder resistor on a high-voltage

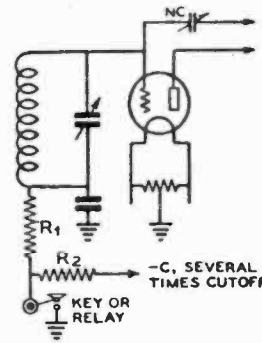

Figure 34.

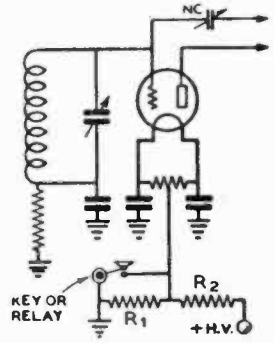

Figure 35.

COMMON BLOCKED-GRID KEYING CIRCUITS.

plate supply. Some provision should be included in the transmitter-control system to apply a comparatively *low* (20,000 to 50,000 ohms) value of bleeder resistor across the high-voltage plate supply except during the period when actually keying the transmitter.

Blocked-Grid Keying

The negative grid bias in a medium- or low-power r-f amplifier can easily be increased in magnitude sufficiently to reduce the amplifier output to zero. The circuits shown in Figures 34 and 35, represent two methods of such blocked-grid keying.

In Figure 34, R_1 is the usual grid leak. Additional fixed bias is applied through a 100,000-ohm resistor R_2 to block the grid current and reduce the output to zero. As a general rule, a small 300- to 400-volt power supply with the positive side connected to ground can be used for the additional C-bias supply.

The circuit of Figure 35 can be applied by connecting the key across a portion of the plate supply bleeder resistance. When the key is open, the high negative bias is applied to the grid of the tube, since the filament center tap is connected to a positive point on the bleeder resistor. Resistor R_3 is the normal bleeder; an additional resistor of from one-fourth to one-half the value of R_3 is connected in the circuit for R_1 . A disadvantage of this circuit is that one side of the key may be placed at a positive potential of several hundred volts above ground, with the attendant danger of shock to the operator. Blocked-grid keying is not particularly effective for eliminating key clicks unless lag circuits are incorporated to reduce the clicks to an acceptable value. Key clicks can be reduced to a satisfactory value when using the circuit of Figure 34 by paralleling a 0.1- μ f. paper capacitor across the mica capacitor shown connected from the bottom end of the grid tank circuit to ground.

Oscillator Keying, Break-in

A stable and quick-acting crystal oscillator may be keyed in the plate, cathode or screen-grid circuit for break-in operation.

Considerations pertaining to keying of crystal oscillators are covered earlier in this chapter under crystals and crystal oscillators.

Assuming that the crystal oscillator itself is capable of being keyed without clicks, it is still possible to transmit serious keying sideband clicks if the oscillator is followed by several heavily driven amplifier stages. A heavily-excited Class C amplifier or multiplier acts like a "clipper" stage, tending to square up a rounded excitation impulse, and the cumulative effect of several such stages cascaded is sufficient to square up the "softened" characters out of the oscillator to the point where bad clicks result. The cure is to start at the stage driving the final amplifier, and, working back towards the oscillator, reduce the excitation to each stage to the point where a barely perceptible decrease in antenna power is observed.

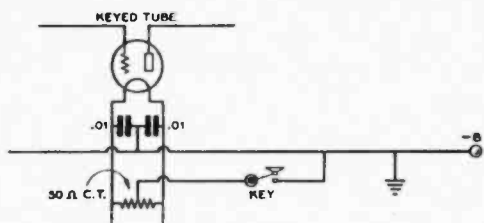

Figure 36.

CENTER TAP KEYING.

The center tap of the filament transformer must not be grounded, and must feed only the stage or stages to be keyed. The grid bias should be returned to ground rather than to center tap.

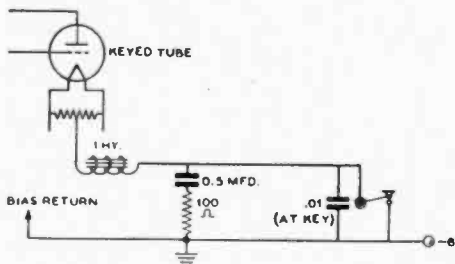

Figure 37.

CENTER TAP KEYING WITH FILTER.

The constants shown are optimum for typical values of plate voltage and plate current, under average conditions. However, some alteration of these values may be required in some instances to give complete suppression of clicks. When high plate voltage is used, a relay should be substituted for the key.

Parasitics with Oscillator Keying When keying in the crystal stage, or, for that matter, any stage ahead of the final amplifier, the stages following the keyed one must be absolutely stable so that parasitic or output frequency oscillation will not occur when the excitation is rising on the beginning of each keying impulse. This type of oscillation gives rise to extremely offensive clicks which cannot be eliminated by any type of filter; in fact, a filter designed to slow up the rate at which signal comes to full strength may only make them worse.

Center-Tap Keying The lead from the center-tap connection to the filament of an r-f amplifier or oscillator tube can be opened and closed for keying a circuit (Figure 36). This opens the B-minus circuit, and at the same time opens the grid-bias return lead. For this reason, the grid circuit is blocked at the same time that the plate circuit is

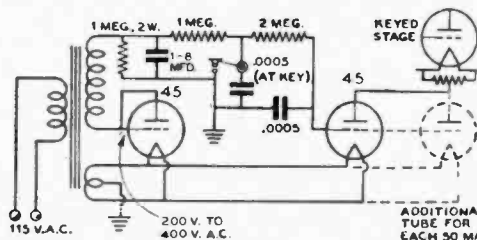

Figure 38.

CENTER TAP KEYING WITH VACUUM TUBE RELAY.

Click suppression is more effectively accomplished when vacuum tubes are used to key the center tap circuit. One type 45 tube should be used for every 50 ma. drawn by the keyed stage. The system becomes uneconomical for high power stages, because of the cost of suitable keyer tubes. Type 6B4-G and 2A3 tubes also may be used as keyer tubes in this circuit.

opened, so that excessive sparking does not occur at the key contacts. Unfortunately, this method of keying applies the power too suddenly to the tube, producing a serious key click. This click often can be eliminated with the key-click eliminator shown in Figure 37.

Vacuum Tube C.T. Keying A variation on the center tap keying circuit of Figure 36 producing virtually no clicks is one in which the key or relay is replaced by

one or more low resistance triodes in parallel, as in Figure 38. These tubes act as a very high resistance when sufficient blocking bias is applied to them, and as a very low resistance when the bias is removed. The desired amount of lag or "cushioning effect" can be obtained by employing suitable resistance and capacitance values in the grid of the keyer tube(s). Because very little spark is produced at the key, due to the small amount of power in the key circuit, sparking clicks are easily suppressed.

The cost of keyer tubes makes this type of keying rather expensive for high power transmitters, but cost is not excessive when the power is low enough that receiver tubes can be employed as keyer tubes. The circuit of Figure 38 will handle a keyed stage operating up to 1000 volts. One type 45 tube should be used for every 50 ma. of plate current. Type 6B4G tubes may also be used; allow one 6B4G tube for every 80 ma. of plate current.

Because of the series resistance of the keyer tubes, the plate voltage at the keyed tube will be about 100 volts less than the power supply voltage. This voltage appears as cathode bias on the keyed tube, assuming the bias return is made to ground, and should be taken into consideration when providing bias. In some cases this voltage alone will provide adequate bias.

Frequency Modulation

THE use of frequency modulation and the allied systems of phase modulation and pulse modulation has become of increasing importance in recent years. For amateur communication frequency and phase modulation offer important advantages in the reduction of broadcast interference and in the elimination of the costly high-level modulation equipment most commonly employed with amplitude modulation. For broadcast work FM offers an improvement in signal-to-noise ratio for the high field intensities available in the local-coverage area of an FM broadcast station.

In this chapter various points of difference between FM and amplitude modulation transmission and reception will be discussed and the advantages of FM for certain types of communication pointed out. Since the distinguishing features of the two types of transmission lie entirely in the modulating circuits at the transmitter and in the detector and limiter circuits in the receiver, these parts of the communication system will receive the major portion of attention.

Modulation As described in Chapter 7, *modulation* is the process of altering a radio wave in accordance with the intelligence to be transmitted. The nature of the intelligence is of little importance as far as the process of modulation is concerned; it is the *method* by which this intelligence is made to give a distinguishing characteristic to the radio wave which will enable the receiver to convert it back into intelligence that determines the type of modulation being used.

Figure 1 is a drawing of an r-f carrier amplitude modulated by a sine-wave audio voltage. After modulation the resultant modulated r-f wave is seen still to vary about the zero axis at a constant rate, but the strength of the individual r-f cycles is proportional to the amplitude of the modulation voltage.

In Figure 2, the carrier of Figure 1 is shown frequency modulated by the same modulating voltage. Here it may be seen that modulation voltage of one polarity causes the carrier frequency to decrease, as shown by the fact that the individual r-f cycles of the carrier are spaced farther apart. A modulating voltage of the opposite polarity causes the frequency to increase, and this is shown by the r-f cycles being squeezed together to allow more of them to be completed in a given time interval.

Figures 1 and 2 reveal two very important characteristics

about amplitude- and frequency-modulated waves. First, it is seen that while the amplitude (power) of the signal is varied in AM transmission, no such variation takes place in FM. In many cases this advantage of FM is probably of equal or greater importance than the widely publicized noise reduction capabilities of the system. When 100 per cent amplitude modulation is obtained, the average power output of the transmitter must be increased by 50 per cent. This additional output must be supplied either by the modulator itself, in the high-level system, or by operating one or more of the transmitter stages at such a low output level that they are capable of producing the additional output without distortion, in the low-level system. On the other hand, a frequency-modulated transmitter requires an insignificant amount of power from the modulator and needs no provision for increased power output on modulation peaks. All of the stages between the oscillator and the antenna may be operated as high-efficiency Class B or Class C amplifiers or frequency multipliers.

The second characteristic of FM and AM waves revealed by Figures 1 and 2 is that both types of modulation result in distortion of the r-f carrier. That is, after modulation, the r-f cycles are no longer sine waves, as they would be if no frequencies other than the fundamental carrier frequency were present. It may be shown in the amplitude modulation case illustrated, that there are only two additional frequencies present, and these are the familiar "side frequencies," one located on each side of the carrier, and each spaced from the carrier by a frequency interval equal to the modulation frequency. In regard to frequency and amplitude, the situation is as shown in Figure 3. The strength of the carrier itself does not vary during modulation, but the strength of the side frequencies depends upon the percentage of modulation. At 100 per cent modulation the power in the side frequencies is equal to half that of the carrier.

Under frequency modulation, the carrier wave again becomes distorted, as shown in Figure 2. But, in this case, many more than two additional frequencies are formed. The first two of these frequencies are spaced from the carrier by the modulation frequency, and the additional side frequencies are located out on each side of the carrier and are also spaced from each other by an amount equal to the modulation frequency. Theoretically, there are an infinite number of side

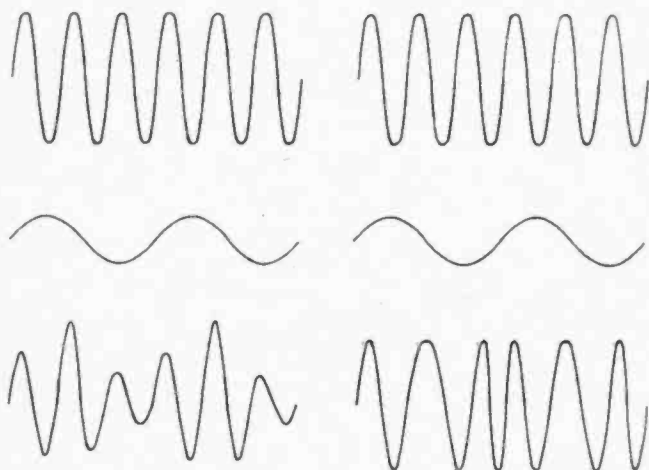

FIGURE 1

FIGURE 2

AMPLITUDE-MODULATED AND FREQUENCY-MODULATED WAVES.

Figure 1 shows a sketch of the scope pattern of an amplitude-modulated wave at the bottom. The upper sketch shows the carrier wave and the center sketch shows the modulating wave.

Figure 2 shows a sketch of the scope pattern of a frequency-modulated wave at the bottom. In this case also the upper sketch shows the carrier wave and the center sketch shows the modulating wave.

frequencies formed, but, fortunately, the strength of those beyond the frequency "swing" of the transmitter under modulation is relatively low.

One set of side frequencies that might be formed by frequency modulation is shown in Figure 4. Unlike amplitude modulation, the strength of the component at the carrier frequency varies widely in FM and it may even disappear entirely under certain conditions. The variation of strength of the carrier component is useful in measuring the amount of frequency modulation, and will be discussed in detail later in this chapter.

One of the great advantages of FM over AM is the reduction in noise at the receiver which the system allows. If the receiver is made responsive only to changes in frequency, a considerable increase in signal-to-noise ratio is made possible through the use of FM, when the signal is of greater strength than the noise. The noise reducing capabilities of FM arise from the inability of noise to cause appreciable frequency modulation of the noise-plus-signal voltage which is applied to the detector in the receiver.

FM Terms Unlike amplitude modulation, the term "percentage modulation" means little in FM practice, unless the receiver characteristics are specified. There are, however, three terms, *deviation*, *modulation index*, and *deviation ratio*, which convey considerable information concerning the character of the FM wave.

Deviation is the amount of frequency shift each side of the unmodulated or "resting" carrier frequency which occurs when the transmitter is modulated. Deviation is ordinarily measured in kilocycles, and in a properly operating FM transmitter it will be directly proportional to the amplitude of the modulating signal. When a symmetrical modulating signal is applied to the transmitter, equal deviation each side of the resting frequency is obtained during each cycle of the modulating signal, and the total frequency range covered by the FM transmitter is sometimes known as the "swing." If, for instance, a transmitter operating on 1000 kc. has its frequency shifted from 1000 kc. to 1010 kc., back to 1000 kc., then to 990 kc., and again back to 1000 kc. during one cycle of the

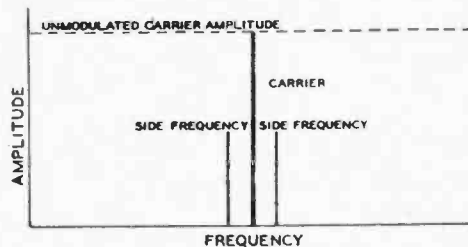

Figure 3.

AM SIDE FREQUENCIES.

For each AM modulating frequency, a pair of side frequencies is produced. The side frequencies are spaced away from the carrier by an amount equal to the modulation frequency, and their amplitude is directly proportional to the amplitude of the modulation. The amplitude of the carrier does not change under modulation.

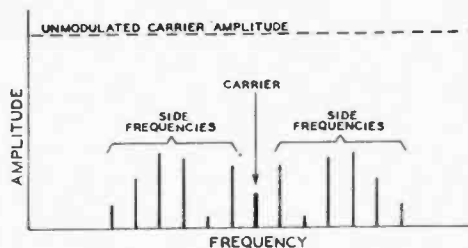

Figure 4.

FM SIDE FREQUENCIES.

With FM each modulation frequency component causes a large number of side frequencies to be produced. The side frequencies are separated from each other and the carrier by an amount equal to the modulation frequency, but their amplitude varies greatly as the amount of modulation is changed. The carrier strength also varies greatly with frequency modulation. The side frequencies shown represent a case where the deviation each side of the "carrier" frequency is equal to five times the modulating frequency. Other amounts of deviation with the same modulation frequency would cause the relative strengths of the various sidebands to change widely.

modulating wave, the *deviation* would be 10 kc. and the *swing* 20 kc.

The *modulation index* of an FM signal is the ratio of the deviation to the audio modulating frequency, when both are expressed in the same units. Thus, in the example above, if the signal is varied from 1000 kc. to 1010 kc. to 990 kc. and back to 1000 kc. at a rate (frequency) of 2000 times a second, the modulation index would be 5, since the deviation (10 kc.) is 5 times the modulating frequency (2000 cycles, or 2 kc.).

The relative strengths of the FM carrier and the various side frequencies depend directly upon the modulation index, these relative strengths varying widely as the modulation index is varied. In the preceding example, for instance, side frequencies occur on the high side of 1000 kc. at 1002, 1004, 1006, 1008, 1010, 1012, etc., and on the low frequency side at 998, 996, 994, 992, 990, 988, etc. In proportion to the unmodulated carrier strength (100 per cent), these side frequencies have the following strengths, as indicated by a modulation index of 5: 1002 and 998—33 per cent, 1004 and 996—5 per cent, 1006 and 994—36 per cent, 1008 and 992—39 per cent, 1010 and 990—26 per cent, 1012 and 988—13 per cent. The carrier strength (1000 kc.) will be 18 per cent of its unmodulated value. Changing the amplitude of the modulating signal will change the deviation, and thus the modulation index will be changed, with the result that the side frequencies, while still located in the same places, will have widely different strength values from those given above.

The *deviation ratio* is similar to the modulation index in that it involves the ratio between a modulating frequency and deviation. In this case, however, the deviation in question is the peak frequency shift obtained under full modulation, and

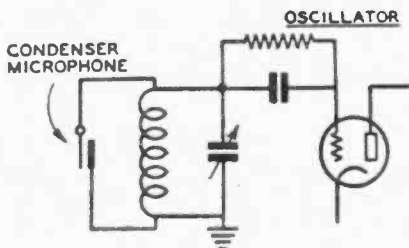

Figure 5.

SIMPLE FREQUENCY MODULATOR.

The variations in capacitance of a capacitor microphone as sound strikes the diaphragm will cause a corresponding variation in the oscillator frequency.

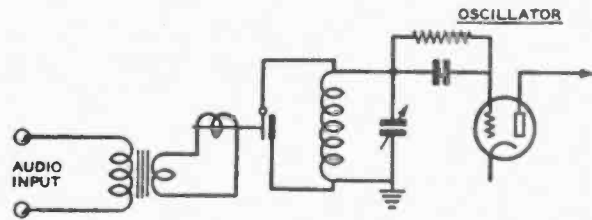

Figure 6.

ELECTRICALLY DRIVEN CAPACITOR MODULATOR.

Certain types of audio reproducers, such as earphones and recorders, may be mechanically connected to one plate of a small variable capacitor to give frequency modulation. It is important that the driving unit be of the "constant amplitude" type.

the audio frequency to be considered is the maximum audio frequency to be transmitted. When the maximum audio frequency to be transmitted is 5000 cycles, for example, a deviation ratio of 3 would call for a peak deviation of 3×5000 , or 15 kc. at full modulation. The noise-suppression capabilities of FM are directly related to the deviation ratio. As the deviation ratio is increased, the noise suppression becomes better if the signal is somewhat stronger than the noise. Where the noise approaches the signal in strength, however, low deviation ratios allow communication to be maintained in many cases where high-deviation-ratio FM and conventional AM are incapable of giving service. This assumes that a narrow-band FM receiver is in use. For each value of signal-to-noise ratio at the receiver, there is a maximum deviation ratio which may be used, beyond which the signal becomes smothered in the noise. Up to this critical deviation ratio, however, the noise suppression becomes progressively better as the deviation ratio is increased.

For high-fidelity FM broadcasting purposes, a deviation ratio of 5 is ordinarily used, the maximum audio frequency being 15,000 cycles, and the peak deviation at full modulation being 75 kc. Since a swing of 150 kc. is covered by the transmitter, it is obvious that wideband FM transmission must necessarily be confined to the ultra-high frequencies, where room for the signals is available.

For strictly communication work, where the noise-suppression advantages of FM must be realized under adverse signal-to-noise ratios, and where maximum coverage for a given amount of power is of prime importance, deviation ratios of 1 to 3 will be found most satisfactory.

Bandwidth Required by FM As the above discussion has indicated, many side frequencies are set up when a radio-frequency carrier is frequency modulated; theoretically, in fact, an infinite number of side frequencies is formed. Fortunately, however, the amplitudes of those side frequencies falling outside the frequency range over which the transmitter is "swung" are so small that most of them may be ignored. In FM transmission, when a complex modulating wave (speech or music) is used, still additional side frequencies resulting from a beating together of the various frequency components in the modulating wave are formed. This is a situation that does not occur in amplitude modulation and it might be thought that the large number of side frequencies thus formed might make the frequency spectrum produced by an FM transmitter prohibitively wide. Analysis shows, however, that the additional side frequencies are of very small amplitude, and, instead of increasing the bandwidth, modulation by a complex wave actually reduces the effective bandwidth of the FM wave. This is especially true when speech modulation is used, since most of the power in voiced sounds is concentrated at low frequencies in the vicinity of 400 cycles.

When all factors are considered, it is found that an FM signal will occupy an effective bandwidth of about $2\frac{1}{2}$ times the maximum deviation at full modulation.

8-1 Frequency Modulation Circuits

A successful frequency modulated transmitter must meet two requirements: (1) The frequency deviation must be symmetrical about a fixed frequency, for symmetrical modulation voltage. (2) The deviation must be directly proportional to the amplitude of the modulation, and independent of the modulation frequency. There are several methods of frequency modulation which will fulfill these requirements. Some of these methods will be described in the following paragraphs.

Mechanical Modulators The arrangement shown in Figure 5 is undoubtedly the simplest of all frequency modulators. A capacitor microphone is connected across the oscillator tank circuit, and the variations in capacitance produced by the microphone cause the oscillator frequency to vary at the frequency of the impressed sound. Since capacitor microphones are difficult to obtain, and the amount of r-f voltage which may be safely impressed across them is small, the circuit is of little practical use, however. Figure 6 shows a modification of Figure 5 which is more suited to practical application. Here the variable-capacitance device which varies the frequency consists of a capacitor, one plate of which is moved by being mechanically coupled to an electro-mechanical driving unit such as a loud speaker or phonograph recording head. This circuit, while practical, is seldom used, because most driving units do not give frequency modulation which complies with requirement (2). The requirement is met by piezo-electric (crystal) reproducers such as earphones and recorders, however, and this type of "constant amplitude" driving unit may be used successfully.

Reactance-Tube Modulators One of the most practical ways of obtaining wide-band frequency modulation is through the use of a reactance-tube modulator. In this arrangement the modulator plate-cathode circuit is connected across the oscillator tank circuit, and made to appear as either a capacitive or inductive reactance by exciting the modulator grid with a voltage which either leads or lags the oscillator tank voltage by 90 degrees. The leading or lagging grid voltage causes a corresponding leading or lagging plate current, and the plate-cathode circuit appears as a capacitive or inductive reactance across the oscillator tank circuit. When the transconductance of the modulator tube is varied, by varying one of the element voltages, the magnitude of the reactance across the oscillator tank is varied. By applying audio modulating voltage to one of the elements, the transconductance, and hence the frequency, may be varied at an audio rate. When properly designed and operated, the re-

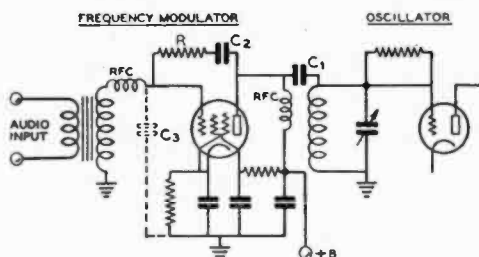

Figure 7.

REACTANCE-TUBE MODULATOR.

This is a popular form of frequency modulator. The operation of the circuit is described in the text.

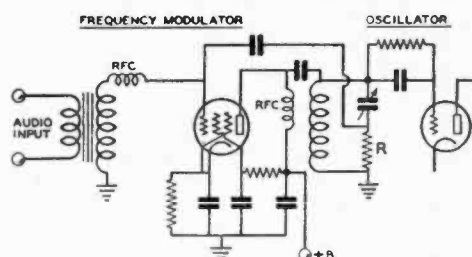

Figure 8.

REACTANCE TUBE MODULATOR.

This circuit operates similarly to the one shown in Figure 7. The difference between the two lies in the method in which the r-f grid voltage is shifted 90 degrees in phase from the r-f plate voltage.

reactance-tube modulator gives linear frequency modulation, and is capable of producing large amounts of deviation.

There are numerous possible configurations of the reactance-tube modulator circuit. The difference in the various arrangements lies principally in the type of phase-shifting circuit used to give a grid voltage which is in phase quadrature with the r-f voltage at the modulator plate.

Figure 7 is a diagram of one of the most popular forms of reactance-tube modulators. The modulator tube, which is usually a sharp cutoff pentode such as a 6J7 or 6SJ7, has its plate coupled through a blocking capacitor, C_1 , to the "hot" side of the oscillator grid circuit. Another blocking capacitor, C_3 , feeds r.f. to the phase shifting network $R-C_2$ in the modulator grid circuit. If the resistance of R is made large in comparison with the reactance of C_2 at the oscillator frequency, the current through the $R-C_2$ combination will be nearly in phase with the voltage across the tank circuit, and the voltage across C_2 will lag the oscillator tank voltage by almost 90 degrees. The result of the 90-degree lagging voltage on the modulator grid is that its plate current lags the tank voltage by 90 degrees, and the reactance tube appears as an inductance in shunt with the oscillator inductance, thus raising the oscillator frequency.

The phase-shifting capacitor C_2 is usually provided by the input capacitance of the modulator tube and stray capacitance between grid and ground, and it will not ordinarily be found necessary to employ an actual capacitor for this purpose at frequencies above 2 or 3 Mc. Resistance R will usually have a value of between 25,000 and 100,000 ohms. Either resistance or transformer coupling, as shown, may be used to feed audio voltage to the modulator grid. When a resistance coupling is used, it is necessary to shield the grid circuit adequately, since the high impedance grid circuit is prone to pick up stray r-f and low frequency a-c voltage, and cause undesired frequency modulation. Another disadvantage to the use of a resistance in the grid circuit is that small amounts of grid current may bias the grid of the reactance tube to the point where its effectiveness as a modulator is reduced considerably.

Another of the numerous practical reactance-tube circuits is shown in Figure 8. In this circuit, the 90-degree phase shift in grid excitation to the modulator is obtained by placing a resistor in series with the oscillator tank capacitor. Since the current through the tank capacitor leads the voltage across the tank circuit by 90 degrees, the r-f voltage applied to the modulator grid will also lead this voltage by the same amount; the modulator plate current will lead the tank voltage, and the modulator tube will appear as a capacitor.

The resistor, R , may be placed in series with the tank coil, rather than the capacitor, in which case the phase relationships are such that the reactance tube appears as an inductance. Too much resistance in either leg of the oscillator tank will result in such a low Q circuit that it will be impossible to maintain oscillation. Carbon resistors of around 25 ohms will provide

sufficient excitation to the modulator for good sensitivity.

There are several possible variations of the basic reactance-tube modulator circuits shown in Figures 7 and 8. The audio input may be applied to the suppressor grid, rather than the control grid, if desired. This method requires that the control grid be returned to ground through a rather high resistance (250,000 ohms to 1 megohm) or through an r-f choke. Another modification is to apply the audio to a grid other than the control grid in a mixer or pentagrid converter tube which is used as the modulator. Generally, it will be found that the transconductance variation per volt of control-element voltage variation will be greatest when the control (audio) voltage is applied to the control grid. In cases where it is desirable to separate completely the audio and r-f circuits, however, applying audio voltage to one of the other elements will often be found advantageous in spite of the somewhat lower sensitivity.

In spite of the fact that high-plate resistance pentodes are usually used as reactance tubes, it will often be found that amplitude modulation due to loading of the oscillator by the reactance tube takes place when a large amount of frequency modulation is attempted. The cure for this type of amplitude modulation will usually be found in adjusting the phase of the r-f voltage applied to the reactance tube grid until it differs somewhat from the recommended 90-degree relation with the r.f. at the plate. One such method consists of using the reactance-tube circuit shown in Figure 7 in conjunction with a Hartley or Colpitts oscillator, in which the center of the oscillator tank circuit is grounded for r.f. In this case, both ends of the oscillator coil will be equally "hot," and the C_2-R combination may be connected to the opposite end of the tank circuit from which the reactance-tube plate is connected. Then, by adjustment of C_2 or R , the phase shift between grid and plate may be made more than 90 degrees, and amplitude modulation balanced out.

A circuit which allows the phase shift to be set exactly at 90 degrees, or to be varied either way, is shown in Figure 9. This circuit uses a separate tuned circuit in the reactance-tube grid. The additional circuit may be coupled to the oscillator either by a link, as shown, or simply by placing the two coils close to each other. When the L_1-C_1 circuit is tuned to resonance, the voltage developed across it will be 90° out of phase with the voltage across the oscillator tank. Detuning the L_1-C_1 circuit in one direction or the other will cause the phase shift to become greater or less than 90°.

To reduce the excitation applied to the grid of the reactance tube and to make the tuning of the phase-shifting network less critical, a resistance R , may be placed across the circuit. The resistor may have a value as low as a few hundred ohms, and it will be found that large changes in the value of resistance will make it necessary to change the setting of C_1 to maintain the correct amount of phase shift.

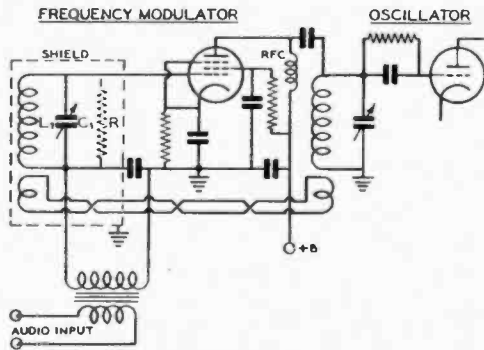

Figure 9.
TUNED PHASE-SHIFT CIRCUIT.

By using a tuned circuit, L_1-C_1 , to shift the phase of the reactance-tube grid excitation, the phase shift may be adjusted to reduce the loading on the oscillator under modulation.

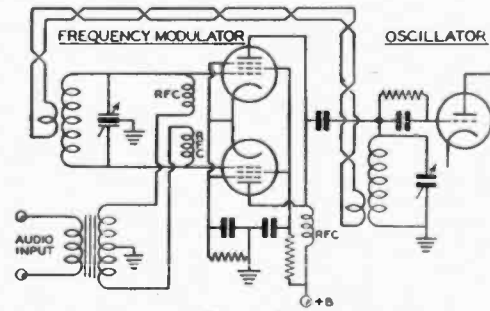

Figure 10.
STABILIZED REACTANCE-TUBE MODULATOR.

Frequency shift due to voltage changes on the modulator may be greatly reduced by the use of this circuit. Changes in element voltages cause equal and opposite changes in reactance in the two modulators, thus minimizing the frequency shift. The reactance-tubes' grids receive excitation from a balanced tuned circuit so that one tube receives voltage lagging the oscillator tank voltage by 90° , while the other tube is excited with a voltage that leads the tank voltage by 90° .

Adjusting the Phase Shift One of the simplest methods of adjusting the phase shift to the correct amount is to place a pair of earphones in series with the oscillator cathode-to-ground circuit and adjust the phase-shift network until minimum sound is heard in the 'phones when frequency modulation is taking place. If an electron-coupled or Hartley oscillator is used, this method requires that the cathode circuit of the oscillator be inductively or capacitively coupled to the grid circuit, rather than tapped on the grid coil. The 'phones should be adequately by-passed for r.f. of course.

Stabilization Due to the presence of the frequency modulator, the stabilization of an FM oscillator in regard to voltage changes is considerably more involved than in the case of a simple self-controlled oscillator for transmitter frequency control. If desired, the oscillator itself may be made perfectly stable under voltage changes, but the presence of the frequency modulator destroys the beneficial effect of any such stabilization. It thus becomes desirable to apply the stabilizing arrangement to the modulator as well as the oscillator. If the oscillator itself is stable under voltage changes, or, in other words, self-compensated by some means such as the use of an electron-coupled circuit, it is only necessary to apply voltage-frequency compensation to the modulator. Stabilized power supply arrangements suitable for use on the modulator or both modulator and oscillator are described fully in Chapter 25.

A circuit in which automatic stabilization of the effects of voltage variations on the modulator is obtained, is shown in Figure 10. In this circuit, the reactance-tube grids are connected in push-pull across the phase-shifting circuit L_1-C_1 , while the plates are connected in parallel and tied to the oscillator tank in the usual manner. Any variation in the plate-supply voltage to the reactance tubes causes equal and opposite effects in their reactance, and there is no net reactance variation.

Another method of oscillator stabilization makes use of a discriminator circuit. This arrangement stabilizes the frequency against changes arising from any cause (except the desired modulation) by comparing the oscillator frequency with a crystal controlled standard and applying the proper compensating voltages. A block diagram of this method is shown in Figure 11. Output from one of the stages of the transmitter is mixed with the output of a crystal oscillator to give an "intermediate frequency" output which is applied to a conventional discriminator. The discriminator, which will be more completely described later in this chapter, is a circuit arrangement to produce an output voltage which depends on the frequency of the r.f. applied to it.

The d-c voltage produced by the discriminator is applied

to a reactance tube tied across the oscillator tank circuit. As the average or "center" frequency varies one way or the other from the correct value, a positive or negative voltage appears across the discriminator load resistors. When this voltage is placed on the control element of the reactance tube, it attempts to restore the center (mid-modulation or unmodulated) radio frequency to a value which gives zero voltage output from the discriminator. The oscillator can never be fully restored to its correct frequency, however, since the discriminator output voltage would then be zero, and no frequency correction would be taking place. The frequency is actually shifted back to a value somewhere between what it should be and what it would have been without stabilization. The reactance tube which takes care of the frequency correction may also be used as the modulator, and the frequency stabilizing voltage may be applied in series with the audio voltage or, alternatively, it may be applied to another of the tube elements. The audio output of the discriminator must be removed by a simple R-C filter so that the compensating voltage is direct current without superimposed audio. The audio output of the discriminator may be used for monitoring purposes, if desired. Obviously the stability of the complete arrangement is dependent upon the stability of the discriminator components under temperature and humidity changes, and upon the stability of the crystal oscillator. Ordinarily the stability of the crystal oscillator will be sufficiently great that the discriminator will be the limiting factor in the amount of stabilization obtainable.

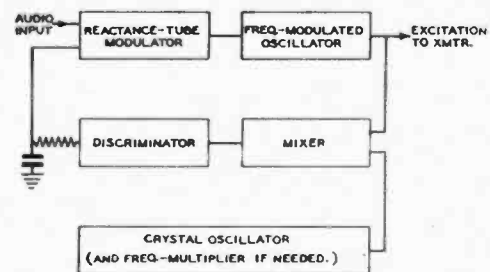

Figure 11.
DISCRIMINATOR STABILIZING ARRANGEMENT.

A frequency-modulated oscillator may be stabilized against undesired frequency shift by comparing the transmitter frequency with that of a crystal oscillator. The difference between the two frequencies is applied to a discriminator circuit, and any change from a predetermined difference will cause the discriminator to restore the transmitter to its correct frequency. An R-C filter is used to remove the audio modulation from the discriminator output.

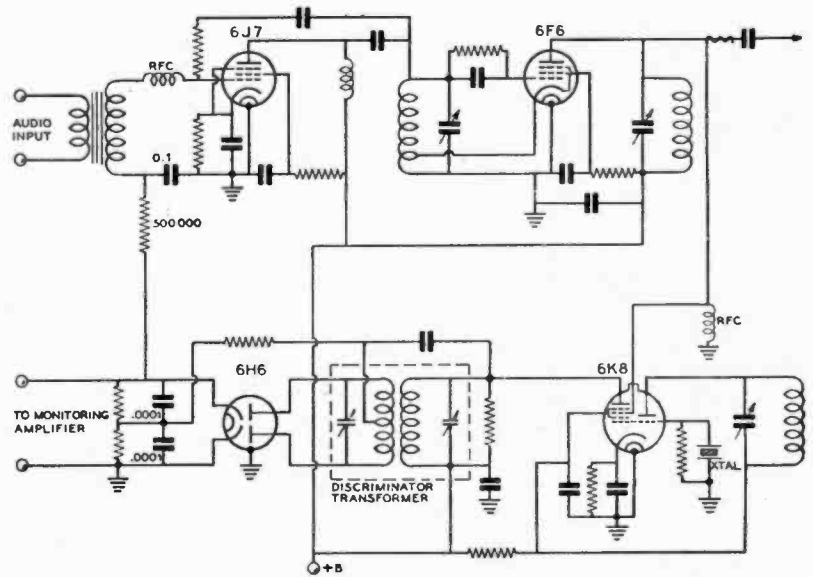

Figure 12.
TYPICAL STABILIZATION CIRCUIT.
A schematic diagram of the arrangement shown in block-diagram style in Figure 11. For maximum sensitivity, the discriminator should operate on a frequency around 455 kilocycles.

making it necessary to use discriminator components (especially the tuned input transformer) of good quality. A typical stabilizing circuit, with provision for monitoring, is shown in Figure 12.

The frequency of the crystal used in the stabilizing circuit will depend upon the frequency at which the discriminator operates, and the frequency of the stage in the transmitter from which the stabilizer signal is taken. If a b.c. replacement-type discriminator transformer designed for a frequency in the 400-500 kc. range is used, the r-f input for the stabilizer may be obtained from the transmitter oscillator stage, or if more sensitivity is desired, from the plate circuit of the frequency multiplier following the oscillator. The crystal oscillator must operate on a frequency such that its fundamental, or one of its harmonics, falls at a frequency which differs from that of the transmitter stage applied to the stabilizer by an amount equal to the discriminator frequency. If the required crystal frequency falls higher than is easily obtainable with a crystal, it may be necessary to use a frequency multiplier after the crystal stage.

Linearity Test It is almost a necessity to run a static test on the reactance-tube frequency modulator to determine its linearity and effectiveness, since small changes in the values of components, and in stray capacitances will almost certainly alter the modulator characteristics. A frequency-versus-control-voltage curve should be plotted to ascertain that equal increments in control voltage, both in a positive and a negative direction, cause equal changes in frequency. If the curve shows that the modulator has an appreciable amount of non-linearity, changes in bias, electrode voltages, and resistance values may be made to obtain a straight-line characteristic.

Figure 13 shows a method of connecting two 4½-volt C batteries and a potentiometer to plot the characteristic of the modulator. It will be necessary to use a zero-center voltmeter to measure the grid voltage, or else reverse the voltmeter leads when changing from positive to negative grid voltage. When a straight-line characteristic for the modulator is obtained by the static test method, the capacitances of the various by-pass capacitors in the circuit must be kept small to retain this characteristic when an audio voltage is used to vary the frequency in place of the d-c voltage with which the characteristic was plotted.

Use of the Reactance-Tube Modulation System

Due to the complexity of the circuits involved in obtaining center-frequency stabilization in a reactance-tube-modulated FM transmitter, such circuits are not commonly used by amateurs, although the arrangement is frequently used in commercial FM transmitters. Reactance-tube modulated transmitters are, however, frequently used *without* stabilization on the 2-meter and 1¼-meter bands.

Since narrow-band FM is the only system commonly employed by amateurs on the bands below 54 Mc., reactance-tube modulation of the transmitter is not completely practicable for this type of operation. The reason is simply that the normal instability of a reactance-tube modulated transmitter (without center-frequency stabilization) in kilocycles is greater than the frequency deviation normally employed in narrow-band FM work. Phase modulation of the transmitter affords center-frequency stability substantially equal to crystal control, and therefore it is this system which has found wide application in FM transmitters for narrow-band work on the 6-meter band and below in frequency.

8-2 Phase Modulation

By means of phase modulation (PM) it is possible to dispense with self-controlled oscillators and to obtain directly

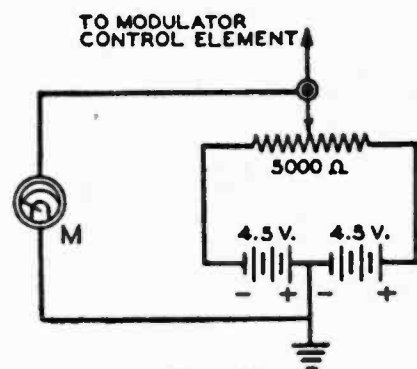

Figure 13.
This circuit allows the control characteristic of the frequency modulator to be easily checked. As the potentiometer arm is moved one way or the other from the center position, a positive or negative voltage is placed on the modulator control element.

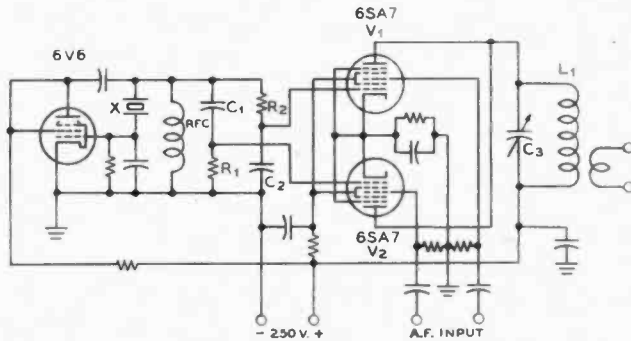

Figure 14.

SIMPLE PHASE-MODULATION CIRCUIT.

The operation of this phase-modulation circuit for obtaining FM is described in detail in the text. R_1C_1 and R_2C_2 comprise the phase-splitting network for the two 6SA7 phase-modulator tubes. The tank circuit L_1C_3 is tuned to the frequency of operation of the crystal.

crystal-controlled FM. In the final analysis, PM is simply frequency modulation in which the deviation is directly proportional to the modulation frequency. If an audio modulating signal of 1000 cycles causes a deviation of $\frac{1}{2}$ kc., for example, a 2000-cycle modulating signal of the same amplitude will give a deviation of 1 kc., and so on. To produce an FM signal, it is necessary to make the deviation independent of the modulation frequency, and proportional only to the amplitude of the modulating signal. With PM this is done by including a frequency correcting network in the audio system of the transmitter. The audio correction network must have an attenuation that varies directly with frequency, and this requirement is easily met by a very simple resistance-capacity network.

The only disadvantage, of PM, as compared to direct FM such as is obtained through the use of a reactance-tube modulator, is the fact that very little frequency deviation is produced directly by the phase modulator. The deviation produced by a phase modulator is independent of the actual carrier frequency on which the modulator operates, but is dependent only upon the phase deviation which is being produced and upon the modulation frequency. Expressed as an equation:

$$F_d = M_p \text{ modulating frequency}$$

Where F_d is the frequency deviation one way from the mean value of the carrier, and M_p is the phase deviation accompanying modulation expressed in radians (a radian is approximately 57.3°). Thus, to take an example, if the phase deviation is $\frac{1}{2}$ radian and the modulating frequency is 1000 cycles, the frequency deviation applied to the carrier being passed through the phase modulator will be 500 cycles.

It is easy to see that an enormous amount of multiplication of the carrier frequency is required in order to obtain from a phase modulator the frequency deviation of 75 to 100 kc. required for commercial FM broadcasting. However, for amateur narrow-band FM work (NBFM) only a quite reasonable number of multiplier stages are required to obtain a deviation ratio of approximately one. Actually, phase modulation of approximately one-half radian on the output of a crystal oscillator in the 80-meter band will give adequate deviation for 29-Mc. NBFM radiotelephony. For example; if the crystal frequency is 3700 kc., the deviation in phase produced is $\frac{1}{2}$ radian, and the modulating frequency is 500 cycles, the deviation in the 80-meter band will be 250 cycles. But when the crystal frequency is multiplied on up to 29,600 kc. the frequency deviation will also be multiplied by 8 so that the resulting deviation on the 10-meter band will be 2 kc. either side of the carrier for

a total swing in carrier frequency of 4 kc. This amount of deviation is quite adequate for NBFM work.

Odd-harmonic distortion is produced when FM is obtained by the phase-modulation method, and the amount of this distortion that can be tolerated is the limiting factor in determining the amount of PM that can be used. Since the aforementioned frequency-correcting network causes the lowest modulating frequency to have the greatest amplitude, maximum phase modulation takes place at the lowest modulating frequency, and the amount of distortion that can be tolerated at this frequency determines the maximum deviation that can be obtained by the PM method. For high-fidelity broadcasting, the deviation produced by PM is limited to an amount equal to about one-third of the lowest modulating frequency. But for amateur NBFM work the deviation may be as high as 0.6 of the modulating frequency before distortion becomes objectionable on voice modulation. In other terms this means that phase deviations as high as 0.6 radian may be used for amateur NBFM transmission.

Phase-Modulation Circuits

A large number of circuits have been proposed and described for obtaining phase modulation of a carrier wave. The majority of these circuits are either complex, or require the careful adjustment of one or more critical controls. Hence these circuits are not considered the most desirable for amateur NBFM work, especially when a simple circuit containing no critical adjustments is available for accomplishing the desired result. This simple circuit is shown in Figure 14.

A 6V6 tube, triode connected, is used as a Pierce crystal oscillator in the circuit of Figure 14 to feed the two phase-splitting networks R_1C_1 and R_2C_2 . R_1C_1 effectively advances the phase 45° while R_2C_2 effectively retards the phase 45° from the phase of the voltage generated by the crystal oscillator. Hence, the grids of the two 6SA7 phase-modulator tubes are fed with voltages 90° out of phase. The plates of the two 6SA7 tubes are connected in parallel and thence to the tank circuit L_1C_3 . This tank circuit is tuned to the frequency of the crystal oscillator. Then, as we apply push-pull audio voltage to the signal grids of the two 6SA7 tubes the G_m of one tube is effectively decreased while the G_m of the other is increased on one half of the input audio cycle, and the reverse effect takes place on the other half of the audio cycle. When the G_m of V_1 is increased, the G_m of V_2 is decreased and the phase of the voltage across the output tank circuit tends to take on the phase of the voltage generated by V_1 . The converse takes place on the other half of the audio cycle. With this circuit arrangement it is possible to obtain plus-or-minus 35° phase modulation with distortion which is sufficiently low for amateur communications work by means of NBFM. An exciter using this principle of phase modulation to produce FM is shown in Chapter 21. A low-power transmitter is shown in Chapter 23.

It is possible to obtain somewhat greater phase deviation with the circuit of Figure 14 if the voltages on the two 6SA7 grids differ by 120° to 140° but at the expense of somewhat more amplitude modulation from the modulator. At any rate, the circuit is not at all critical as to frequency and will work over a 1.5 to 1 range with no change except the normal tuning of the output tank circuit.

Methods for Obtaining Greater Phase Deviation

When it is desired to utilize phase modulation for obtaining wide-band FM, some method of obtaining phase multiplication greater than that which would be obtained by simple multiplication from the crystal frequency down to the output frequency must be employed. One method is to cascade a series of phase modulator stages such as the one

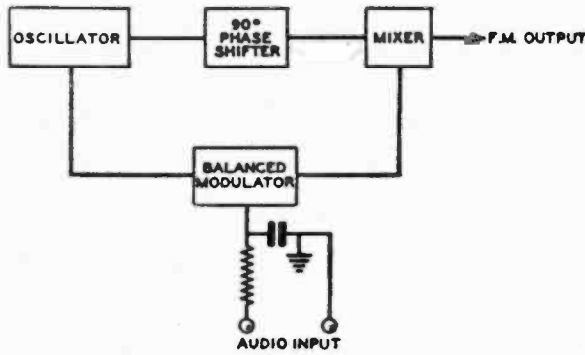

Figure 15.

PHASE MODULATOR BLOCK DIAGRAM.

The R-C network in the audio input leads makes the amount of phase modulation inversely proportional to the audio frequency, thus giving frequency modulated output.

shown in Figure 14 or the one illustrated in Figure 15 or any of the other conventional phase-modulation systems. Another method is to use a moderately high-frequency oscillator followed by a small amount of frequency multiplication, and the signal then "beaten back" by means of a heterodyne oscillator and a mixer to another moderately high-frequency, whence it may be multiplied in the usual manner to the output frequency.

An example of this method is the use of a crystal oscillator, followed by the phase modulator, on 1800 kc. The PM output is tripled to 5400 kc., where the deviation is then 3 times what it originally was. Beating the 5400-kc. output with another crystal oscillator on 7350 kc. gives a difference of frequency of 1950 kc., with the deviation still tripled from its original value. By a series of doublers or quadruplers the 1950-kc. signal may be multiplied 27 times to reach a frequency of 52.65 Mc., which is also in the 52.5 to 54 Mc. amateur band. The increase in deviation will be equal to the product of the two frequency multiplications (3 x 27) or 81 times.

Measurement of Deviation

When a single-frequency modulating voltage is used with an FM transmitter, the relative amplitudes of the various sidebands and the carrier vary widely as the deviation is varied by increasing or decreasing the amount of modulation. Since the relationship between the amplitudes of the various sidebands and carrier to the audio modulating frequency and the deviation is known, a simple method of measuring the deviation of a frequency modulated transmitter is possible. In making the measurement, the result is given in the form of the modulation index for a certain amount of audio input. As previously described, the modulation index is the ratio of the peak frequency deviation to the frequency of the audio modulation.

The measurement is made by applying a sine-wave audio voltage of known frequency to the transmitter, and increasing the modulation until the amplitude of the carrier component of the frequency modulated wave reaches zero. The modulation index for zero carrier may then be determined from the table below. As may be seen from the table, the first point of zero carrier is obtained when the modulation index has a value of 2.405,—in other words, when the deviation is 2.405 times the modulation frequency. For example, if a modulation frequency of 1000 cycles is used, and the modulation is increased until the first carrier null is obtained, the deviation will then be 2.405 times the modulation frequency, or 2.405 kc. If the modulating frequency happened to be 2000 cycles, the deviation at the first null would be 4.810 kc. Other carrier nulls will be obtained when the index is 5.52, 8.654, and at increasing values separated approximately by π . The following is a list-

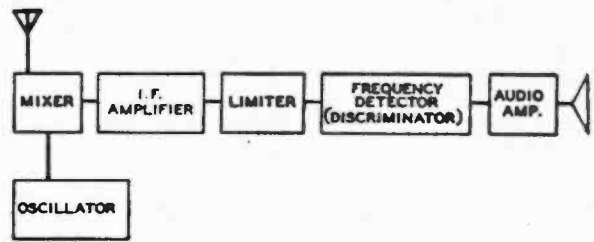

Figure 16.

RECEIVER BLOCK DIAGRAM.

Up to the amplitude limiter stage, the FM receiver is similar to an AM receiver, except for a somewhat wider i-f bandwidth. The limiter removes any amplitude modulation, and the frequency detector following the limiter converts frequency variations into amplitude variations.

ing of the modulation index at successive carrier nulls up to the tenth:

Zero carrier point no.	Modulation index
1	2.405
2	5.520
3	8.654
4	11.792
5	14.931
6	18.071
7	21.212
8	24.353
9	27.494
10	30.635

The only equipment required for making the measurements is a calibrated audio oscillator of good wave form, and a communication receiver equipped with a beat oscillator and crystal filter. The receiver should be used with its crystal filter set for a bandwidth of approximately twice the modulation frequency, to exclude sidebands spaced from the carrier by the modulation frequency. The unmodulated carrier is accurately tuned in on the receiver with the beat oscillator operating, and modulation from the audio oscillator is then applied to the transmitter, and the modulation increased until the first carrier null is obtained. This first carrier null will correspond to a modulation index of 2.405, as previously mentioned. Successive null points will correspond to the indices listed in the table. A volume indicator in the transmitter audio system may be used to measure the audio level required for different amounts of deviation, and the indicator thus calibrated in terms of frequency deviation. If the measurements are made at the fundamental frequency of the oscillator, it will be necessary to multiply the frequency deviation by the harmonic upon which the transmitter is operating, of course. It will probably be most convenient to make the determination at some frequency intermediate between that of the oscillator and that at which the transmitter is operating, and then multiply the result by the frequency multiplication between that point and the transmitter output frequency.

8-3 Frequency-Modulation Reception

In contrast with the transmitter, where the use of FM greatly simplifies the modulation problem, for serious work the use of FM necessitates a receiver somewhat more complicated than would be necessary for amplitude modulation. While ordinary superheterodyne, t.r.f., and superregenerative receivers will receive FM after a fashion, serious work requires a receiver especially designed for FM reception.

The FM receiver must have, first of all, a bandwidth sufficient to pass the range of frequencies generated by the FM transmitter. And since the receiver must be a superheterodyne if it is to have good sensitivity at the frequencies to which FM is restricted, i-f bandwidth is an important factor in its design.

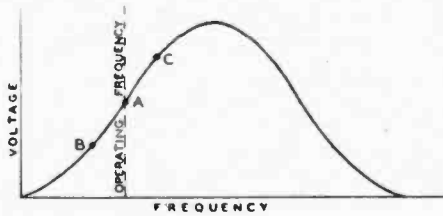

Figure 17.
"OFF TUNE" FREQUENCY DETECTOR.

A portion of the resonance characteristic of a tuned circuit may be used as shown to convert frequency variations into amplitude variations.

The second requirement of the FM receiver is that it incorporate some sort of device for converting frequency changes into amplitude changes, in other words, a detector operating on frequency variations rather than amplitude variations. The third requirement, and one which is necessary if the full noise reducing capabilities of the FM system of transmission are desired, is a limiting device to eliminate amplitude variations before they reach the detector. A block diagram of the essential parts of an FM receiver is shown in Figure 16.

The Frequency Detector The simplest device for converting frequency variations to amplitude variations is an "off-tune" resonant circuit, as illustrated in Figure 17. With the carrier tuned in at point "A," a certain amount of r-f voltage will be developed across the tuned circuit, and, as the frequency is varied either side of this frequency by the modulation, the r-f voltage will increase and decrease to points "C" and "B" in accordance with the modulation. If the voltage across the tuned circuit is applied to an ordinary detector, the detector output will vary in accordance with the modulation, the amplitude of the variation being proportional to the deviation of the signal, and the rate being equal to the modulation frequency. It is obvious from Figure 17 that only a small portion of the resonance curve is usable for linear conversion of frequency variations into amplitude variations, since the linear portion of the curve is rather short. Any frequency variation which exceeds the linear portion will cause distortion of the recovered audio. It is also obvious by inspection of Figure 17 that an AM receiver used in this manner is wide open to signals on the peak of the resonance curve and also to signals on the other side of the resonance curve. Further, no noise limiting action is afforded by this type of reception. This system, therefore, is not recommended for NBFM reception.

Travis Discriminator Another form of frequency detector or discriminator, is shown in Figure 18. In this arrangement two tuned circuits are used, one tuned on each side of the i-f amplifier frequency, and with their resonant frequencies spaced slightly more than the expected transmitter "swing" apart. Their outputs are combined in a differential rectifier so that the voltage across the series load resistors, R_1 and R_2 , is equal to the algebraic sum of the individual output voltages of each rectifier. When a signal at the i-f mid-fre-

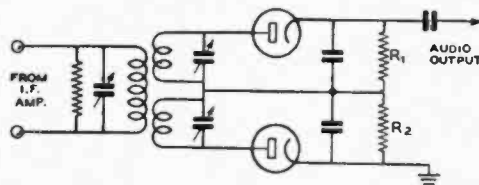
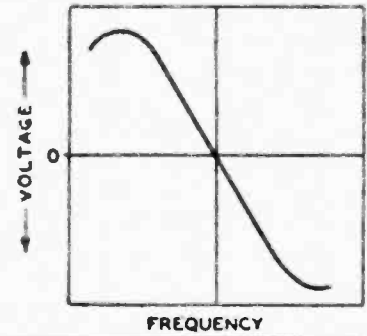

Figure 18.
TRAVIS DISCRIMINATOR.

Figure 19.
DISCRIMINATOR VOLTAGE-FREQUENCY CURVE.

At its "center" frequency the discriminator produces zero output voltage. On either side of this frequency it gives a voltage of a polarity and magnitude which depend on the direction and amount of frequency shift.



quency is received, the voltages across the load resistors are equal and opposite, and the sum voltage is zero. As the r-f signal varies from the mid-frequency, however, these individual voltages become unequal, and a voltage having the polarity of the larger voltage and equal to the difference between the two voltages appears across the series resistors, and is applied to the audio amplifier. The relationship between frequency and discriminator output voltage is shown in Figure 19. The separation of the discriminator peaks and the linearity of the output voltage vs. frequency curve depend upon the discriminator frequency, the Q of the tuned circuits, and the value of the diode load resistors. As the intermediate (and discriminator) frequency is increased, the peaks must be separated further to secure good linearity and output. Within limits, as the diode load resistors or the Q are reduced, the linearity improves, and the separation between the peaks must be greater.

Foster-Seeley Discriminator The most widely used form of discriminator is that shown in Figure 20. This type of discriminator yields an output-voltage-versus-frequency characteristic similar to that shown in Figure 19. Here, again, the output voltage is equal to the algebraic sum of the voltages developed across the load resistors of the two diodes, the resistors being connected in series to ground. However, this Foster-Seeley discriminator requires only two tuned circuits instead of the three used in the previous discriminator. The operation of the circuit results from the phase relationships existing in a transformer having a tuned secondary. In effect, as a close examination of the circuit will reveal, the primary circuit is in series, for r.f., with each half of the secondary to ground. When the received signal is at the resonant frequency of the secondary, the r-f voltage across the secondary is 90 degrees out of phase with that across the primary. Since each diode is connected across one half of the secondary winding and the primary winding in series, the resultant r-f voltages applied to each are equal, and the voltages developed across each diode load resistor are equal and of opposite polarity. Hence, the net voltage between the top of the load resistors and ground is zero. This is shown vectorially in Figure 21A where the resultant voltages R and R' which are applied to the two diodes are shown to be equal when the phase angle between primary and secondary voltages is 90 degrees. If, however, the signal varies from the resonant frequency, the 90-degree phase relationship no longer exists between primary and secondary. The result of this effect is shown in Figure 21B, where the secondary r-f voltage is no longer 90 degrees out of phase with respect to the primary voltage. The resultant voltages applied to the two diodes are now no longer equal, and a d-c voltage proportional to the difference between the r-f voltages applied to the two diodes will exist across the series load resistors. As the signal frequency varies back and forth across the resonant frequency of the discriminator, an a-c voltage of the same frequency as the original modulation, and proportional to the deviation, is developed and passed on to the audio amplifier.

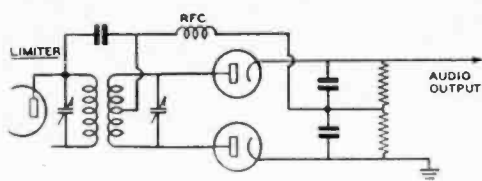

Figure 20.

FOSTER-SEELEY DISCRIMINATOR.

This discriminator depends on the phase relationships between a primary and a tuned secondary for its operation.

Ratio Detector One of the more recent types of FM detector circuits, called the "ratio detector" is diagrammed in Figure 22. The input transformer is essentially the same as the discriminator transformer employed in the Foster-Seeley type discriminator. The r-f choke used must have high impedance at the intermediate frequency used in the receiver. The circuit of the ratio detector appears very similar to that of the more conventional discriminator arrangement. However, it will be noted that the two diodes in the ratio detector are poled so that their d-c output voltages add, as contrasted to the Foster-Seeley circuit wherein the diodes are poled so that the d-c output voltages buck each other. At the center frequency to which the discriminator transformer is tuned the voltage appearing at the top of the 1-megohm potentiometer will be one-half the d-c voltage appearing at the "a-v-c output" terminal—since the contribution of each diode will be the same. However, as the input frequency varies to one side or the other of the tuned value (while remaining within the pass band of the i-f amplifier feeding the detector) the relative contributions of the two diodes will be different. The voltage appearing at the top of the 1-megohm volume control will increase for frequency deviations in one direction and will decrease for frequency deviations in the other direction from the mean or tuned value of the transformer. The audio output voltage is equal to the ratio of the relative contributions of the two diodes, hence the name "ratio detector".

The ratio detector offers several advantages over the simple discriminator circuit. The circuit does not require the use of a limiter preceding the detector since the circuit is inherently insensitive to amplitude modulation on an incoming signal. This factor alone means that the r-f and i-f gain ahead of the detector can be much less than with the conventional discriminator for the same overall sensitivity and insensitivity to noise. Further, the circuit provides a-v-c voltage for controlling the gain of the preceding r-f and i-f stages. The ratio detector is, however, susceptible to variations in the amplitude of the incoming signal, as is any other detector circuit except the discriminator with a limiter preceding it, so that a-v-c should be used on the stages preceding the detector.

Limiters The limiter in an FM receiver using a conventional discriminator serves to remove amplitude modulation and pass on to the discriminator a frequency modulated signal of constant amplitude; a typical circuit is shown in Figure 23. The limiter tube is operated as an i-f stage with very low plate voltage and with grid leak bias, so that it overloads quite easily. Up to a certain point the output of the limiter will increase with an increase in signal. Above this point, however, the limiter becomes overloaded, and further large increases in signal will not give any increase in output. To operate successfully, the limiter must be supplied with a large amount of signal, so that the amplitude of its output will not change for rather wide variations in amplitude of the signal. Noise, which causes little frequency modulation but much amplitude modulation of the received signal is virtually wiped out in the limiter.

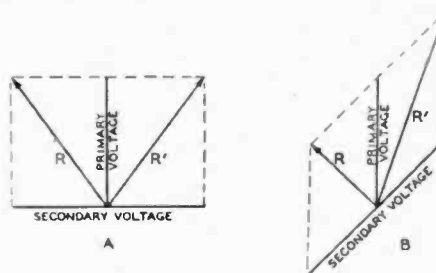

Figure 21.

DISCRIMINATOR VECTOR DIAGRAM.

A signal at the resonant frequency of the secondary will cause the secondary voltage to be 90 degrees out of phase with the primary voltage, as shown at A, and the resultant voltages R and R' are equal. If the signal frequency changes, the phase relationship also changes, and the resultant voltages are no longer equal, as shown at B. A differential rectifier is used to give an output voltage proportional to the difference between R and R'.

The voltage across the grid resistor, R_g , varies with the amplitude of the received signal, and for this reason, conventional amplitude modulated signals may be received on the FM receiver by connecting the input of the audio amplifier to the top of this resistor, rather than to the discriminator output. When properly filtered by a simple R-C circuit, the voltage across R_g may also be used as a-v-c voltage for the receiver. When the limiter is operating properly, a-v-c is neither necessary nor desirable, however.

Receiver Design Considerations One of the most important factors in the design of an FM receiver is the frequency swing which it is intended to handle. It will be apparent from Figure 19 that if the straight portion of the discriminator circuit covers a wider range of frequencies than those generated by the transmitter, the audio output will be reduced from the maximum value of which the receiver is capable.

In this respect, the term "modulation percentage" is more applicable to the FM receiver than it is to the transmitter, since the "modulation capability" of the communication system is limited by the receiver bandwidth and the discriminator characteristic; full utilization of the linear portion of the characteristic amounts, in effect, to "100 per cent" modulation. This means that some sort of standard must be agreed upon, for any particular type of communication, to make it unnecessary to vary the transmitter swing to accommodate different receivers.

Two considerations influence the receiver bandwidth necessary for any particular type of communication. These are the maximum audio frequency which the system will handle, and

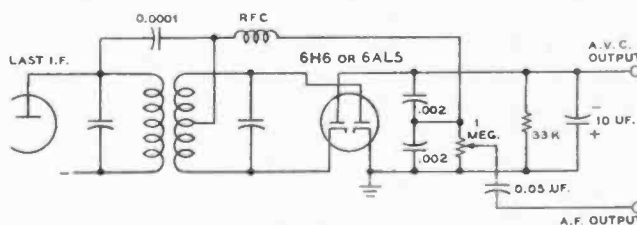

Figure 22.

RATIO DETECTOR CIRCUIT.

The transformer used to feed the diodes in a ratio detector is similar to the one used with a Foster-Seeley discriminator. Note that one of the diodes is reversed and that the output circuit is completely different from that in the discriminator. The ratio detector does not have to be preceded by a limiter as does the discriminator, but the adjustment of the ratio detector is somewhat more difficult to accomplish properly.

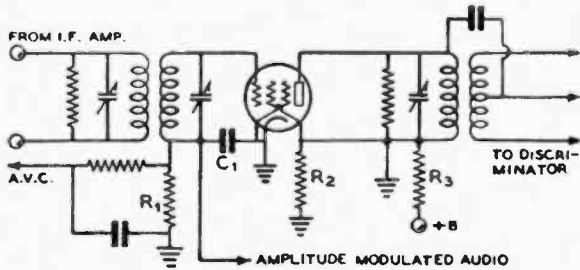

Figure 23.

LIMITER CIRCUIT.

The limiter stage overloads easily, and when overloaded will not reproduce amplitude variations. R_1 may have a value of from 250,000 ohms to 1 megohm. Capacitor C_1 should be rather small, about .0001 μ fd. Resistors R_2 and R_3 should be proportioned so that the plate and screen voltage is from 10 to 30 volts.

the deviation ratio which will be employed. For voice communication, the maximum audio frequency is more or less fixed at 3000 to 4000 cycles. In the matter of deviation ratio, however, the amount of noise suppression which the FM system will provide is influenced by the ratio chosen, since the improvement in signal-to-noise ratio which the FM system shows over amplitude modulation is equivalent to a constant multiplied by the deviation ratio. This assumes that the signal is somewhat stronger than the noise at the receiver, however, as the advantages of wide-band FM in regard to noise suppression disappear when the signal-to-noise ratio approaches unity.

One the other hand, a low deviation ratio is more satisfactory for strictly communication work, where readability at low signal-to-noise ratios is more important than additional noise suppression when the signal is already appreciably stronger than the noise.

As mentioned previously, broadcast FM practice is to use a deviation ratio of 5. When this ratio is applied to a voice-communication system, the total "swing" becomes 30 to 40 kc. With lower deviation ratios, such as are most frequently used for voice work, the swing becomes proportionately less, until at a deviation ratio of 1 the swing is equal to twice the highest audio frequency. Actually, however, the receiver bandwidth must be slightly greater than the expected transmitter swing, since for distortionless reception the receiver must pass the complete band of energy generated by the transmitter, and this band will always cover a range somewhat wider than the transmitter swing.

Regardless of the deviation ratio of the transmitter it should be remembered that the receiver must have a bandwidth sufficiently wide to pass all of the side frequencies of appreciable strength produced by the transmitter. At the same time, the

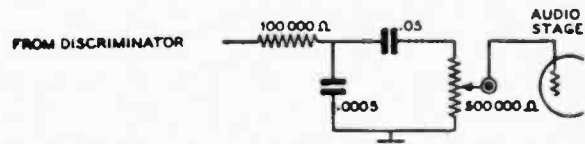

Figure 24.

LOW-PASS FILTER.

A low-pass filter is necessary in the FM receiver to remove high frequency noise components.

selectivity of the i-f channel should be such that the pass band is no wider than is absolutely necessary, since the additional bandwidth in the receiver only serves to decrease the signal-to-noise ratio.

Audio Bandwidth To realize the full noise reducing capabilities of FM, it is essential that the pass band of the audio section of the receiver be limited to that necessary for communication. The noise output of the discriminator is proportional to the audio frequency of the noise, and the improvement in signal-to-noise ratio depends almost entirely on receiver deviation ratio, or the ratio between one-half the r-f bandwidth and the audio bandwidth.

A suitable filter for removing frequencies higher than those necessary for communication is shown in Figure 24. The 100,000-ohm resistor and the .0005- μ fd. capacitor attenuate the higher audio frequencies before they reach the audio amplifier.

"Sub-Carrier" FM Instead of frequency modulating a carrier directly as is done in a conventional FM system, it is possible to make use of a sub carrier. Thus, if a 1000-Mc. carrier is amplitude modulated at 100 kc. to provide a "sub carrier" and the latter is frequency modulated, an indirect method of frequency modulation results.

Instead of a sine-wave sub carrier as a vehicle for the FM intelligence, square wave modulation may be substituted with but little difference in results except for increased band width.

FM Pulse Modulation Certain u-h-f and microwave tubes such as the magnetron are not easily frequency modulated directly, and amplitude modulation of such tubes is limited to a very low percentage if distortion and frequency stability is to be held within tolerable limits. However, such tubes can be amplitude modulated fully with square waves, as such operation is essentially the same as "on-off" keying and linearity is not a consideration. Frequency modulating the comparatively low-frequency square-wave generator is accomplished easily, and a simple, stable system capable of low distortion is the result. The system exhibits the same advantages as regards noise reduction as does conventional FM.

Transmitter Design and Control Principles

COMMUNICATIONS receivers are usually designed as an integral unit, but there is an almost unlimited number of combinations of tubes, exciter circuits, amplifier circuits, power supply arrangements, and control provisions which one may incorporate in a "250-watt" transmitter. For this reason the bulk of the transmitter section of this book has been devoted to units and more or less minor assemblies. However, Chapter 26 has been devoted almost entirely to illustrating the manner in which the various units which make up a transmitter may be grouped together into a major assembly—a complete transmitter.

If a tube requires 25 watts r-f driving power for a certain application, it is obvious that it makes little difference just what exciter circuit is used so long as it puts out 25 watts on the desired bands. Because of its characteristics one exciter may be preferred by one amateur, another exciter by another amateur.

It is fortunate that there is this flexibility with regard to transmitter design, because it makes it easy for an amateur to start out with a low-power transmitter and then add to it from time to time, perhaps later going on phone. It also permits one a certain degree of "custom tailoring" of his transmitter to suit his particular requirements.

The nine chapters in Part II of this book describe a large number of versatile and efficient exciters, power amplifiers, speech amplifiers, modulators, and power supplies. It is the purpose of this chapter to give the reader sufficient general design information to be able to work out various combinations of these independent yet complementary units, and to evolve an assembly which is well suited to his particular needs and pocketbook. However, before proceeding further, one should be thoroughly familiar with the chapter on fundamental transmitter theory, Chapter 6.

9-1 Exciters and Amplifiers

A 5-watt crystal oscillator may be accurately referred to as

a transmitter *when it is used to feed an antenna*. On the other hand a multi-tube r-f unit winding up in a 150-watt power amplifier may be properly termed an exciter *when it is used to drive a higher power amplifier*. Thus we see that any r-f unit, even a simple oscillator, may be either an exciter or a transmitter depending upon how it is used.

The requirements for a low-power (15 to 75 watt) transmitter are practically the same as for an exciter of the same output: the overall efficiency should be good, the unit should cover all the desired bands with a minimum of coil changing and retuning, and both initial cost and upkeep should be low in proportion to the power output.

Virtually all medium- and high-power amplifiers (200-800 watts output) are very much the same except for the particular make and power rating of components used. Perhaps half the amateurs making use of high power use cross-neutralized push-pull final amplifiers which differ only in the method of obtaining bias and method of antenna coupling.

For this reason, several low power r-f units and several medium- and high-power amplifiers are described, and the reader is permitted to use his own ingenuity in working out the combination which appears to fit his requirements. If one is designing a complete transmitter, to which no additions are to be made, it is probably best to decide first upon the final amplifier and then work backwards from there, the driving requirements of the particular tubes used determining the exciter. On the other hand, many amateurs do not have the wherewithal to start right off with high power, and are therefore very likely to decide upon the highest powered r-f unit they can afford and let it go at that. In the latter event, the unit may have slightly more output than is required to drive an amplifier whose addition is contemplated at a later date. However, a reserve of excitation power is not a liability and does not represent poor economy unless carried to extremes. Hence, one who cannot afford to start off with high power can pick out the highest powered exciter he can afford and use it as a transmitter, without worrying too much about its adapt-

ability for use with a particular power amplifier later on. A 75-watt r-f unit is slightly larger than necessary for driving a pair of 35T's, HK54's, 808's, T40's, HY5514's, etc., but there is no reason why one should not use such a combination. *Not enough* excitation is a much more serious condition than an overabundance of excitation *capability*, there being no objection to the latter except from an economic standpoint.

Choosing Tubes Low-power exciters invariably use receiving tubes or "modified" receiving tubes for the sake of economy. Large scale production brings the cost of 42's, 6L6's, etc., down to a price that would be impossible were they designed for and purchased only by amateurs. Some tubes, like the T21 and 807, resemble standard receiving tubes in one or more respects, and while costing more than a standard receiving tube equivalent (6L6G in this case), are still obtainable at a price below that which would be necessary were they not outgrowths of receiving tubes.

The tubes in the high-power amplifier and in the Class B modulator (if used) should be chosen with care. While in general there is little to choose between tubes by reliable manufacturers, some are better adapted than others for certain applications. Also, the more recently released tubes of a particular manufacturer are usually better and less expensive than older tubes of the same general type.

Beam-tetrode tubes such as the 807, 814, 813, 4-125A and 4-250A have much to commend them both for r-f amplifier use and for use as modulators. Tubes of this type require far less excitation both for r-f and audio use than triodes of equivalent plate dissipation and purchase price. However, it must always be kept in mind, when planning a transmitter, that much more attention must be given to shielding and elimination of parasitic circuits when using beam tetrodes than when using triodes. This condition is a natural consequence of the much greater power sensitivity of the beam-tetrode type tube.

Tubes for modulator service should have good emission and adequate plate dissipation. Interelectrode capacitances are relatively unimportant. For triode Class B modulator service the usual practice is to use high- μ ("zero bias") tubes so that little or no bias will be required. In the interest of economy it is often wise to work out a tube combination such that the modulator may be operated from the same plate supply as the final amplifier. It is *much* less expensive to increase the power capability of one power supply by 50 to 75 per cent than to build a separate power supply for the Class B modulator. Also, there is nothing whatever objectionable about running both the modulator and modulated amplifier from the same power supply provided that the supply has been designed to have adequate current capability for both stages with reasonably good regulation.

For service as frequency multipliers, beam tetrodes and pentodes will give the best service. These types of tubes will operate at higher plate-circuit efficiency with less excitation and bias than will a triode of equivalent plate dissipation.

For triode Class C or Class B r-f amplifier service, the amplification factor is not too important, though tubes with a medium-high μ (20 to 40) are most popular.

In Class A or Class AB audio/driver service, triodes with low amplification factor are to be preferred, though pentodes or beam tetrodes may be used provided they are included within an inverse-feedback loop. Shunt feedback from the plate of the beam tube to the plate of the preceding audio stage is quite effective and has been shown in several of the audio systems in Part II of this Handbook.

Driving Power It is always advisable to have a slight reserve of driving power in order to be on the safe side. Therefore, the potential output of an exciter on

the band upon which its output is least (usually the highest frequency band) should be slightly greater than the excitation requirements of the following stage as determined from the manufacturer's tube data.

Plate modulated Class C amplifiers require the most excitation, the tube requiring full maximum rated grid current, and at least $2\frac{1}{2}$ times cutoff bias if full plate input is run.

C-w and buffer amplifiers should preferably be run at full rated grid current (though they *may* run with as much as 50 per cent less) and at $1\frac{1}{2}$ times cutoff or greater bias. Thus an unmodulated final amplifier or buffer can be used with considerably less excitation than a plate-modulated stage of the same power.

Cathode-modulated amplifiers require about the same amount of excitation power as c-w amplifiers, the bias being greater but the grid current much less. Cathode-modulated stages are commonly run at from $2\frac{1}{2}$ to 4 times cutoff bias at approximately an eighth the grid current recommended for plate modulation.

High-efficiency grid modulation requires still less excitation. The bias is from 2 to 4 times cutoff but the grid current is very low, seldom greater than a few ma. even for high power stages. The power dissipated in the grid swamping resistor, a necessary adjunct to a correctly operated grid-modulated stage, keeps the excitation requirements from being even less than they are.

The excitation required for a typical 200-watt-output triode amplifier will run about as follows: plate modulated, 35 watts; c.w. or buffer, 20 watts; cathode modulated, 15 watts; grid modulated, 8 watts. The whole problem of excitation requirements depends so much upon operating conditions that one had best refer to the manufacturer's data sheets or to Chapter 17 of this Handbook.

The question of calculating excitation requirements for a doubler stage was not covered in the foregoing discussion, because the excitation power required depends to such a great degree upon the doubler efficiency desired. For high-efficiency doublers, the bias should be at least 5 times cutoff and the grid current about half the maximum rated value for the tube. Thus it is seen that for good doubler efficiency a tube requires as much excitation power as does a plate-modulated stage of the same power output rating.

Also to be taken into consideration, when tentatively planning a transmitter, are such things as the limiting factor in tube design. For instance, in a grid-modulated transmitter, the output is always limited by the plate dissipation, while for plate-modulated phone work either the plate voltage or plate current rating is exceeded first. Thus we see that for grid modulation, a tube with high plate dissipation is of prime importance, while for plate-modulated operation the matter of filament emission and insulation are of greatest importance.

Another thing to be taken into consideration, especially when designing a phone transmitter, is the item of filament voltage. Obviously a saving can be effected if both r-f amplifier tubes and modulator tubes can be run from the same filament winding.

Care should be taken to make sure that the tubes chosen are capable of efficient and safe operation on the highest frequency used.

9-2

Design Considerations

Transmitter Wiring

At the higher frequencies, solid enamelled copper wire is most efficient for r-f leads. Tinned or stranded wire will show greater losses at these frequencies. Tank coil and tank capacitor leads should be of heavier wire than other r-f leads, though there is little point in using wire heavier than is used for the tank coil itself.

All grounds and by-passes in an r-f stage should be made to

a common point, and the grounding points for several stages bonded together with heavy wire.

The best type of flexible lead from the envelope of a tube to a terminal is thin copper strip, cut from thin sheet copper. Heavy, rigid leads to these terminals may crack the envelope glass when a tube heats or cools.

Wires carrying only a.f. or d.c. should be chosen with the voltage and current in mind. Some of the low-filament-voltage transmitting tubes draw heavy current, and heavy wire must be used to avoid voltage drop. The voltage is low, and, hence, not much insulation is required. Filament and heater leads are usually twisted together. An initial check should be made on the filament voltage of all tubes of 25 watts or more plate dissipation rating. This voltage should be measured right at the tube sockets. If it is low, the filament transformer voltage should be raised. If this is impossible, heavier or paralleled wires should be used for filament leads, cutting down their length if possible.

Spark-plug-type high-tension ignition cable makes the best wire for high-voltage leads. This cable will safely withstand the highest voltages encountered in an amateur transmitter. If this cable is used, the high-voltage leads may be cabled right in with filament and other low-voltage leads. For high-voltage leads in low-power exciters, where the plate voltage is not over 450 volts, ordinary radio hookup wire of good quality will serve the purpose. Twisted lamp cord, in good condition with insulation intact, can be used for power-supply leads between low-power exciter units and power supplies where the voltage does not exceed 400 volts.

No r-f leads should be cabled; in fact it is better to use enamelled or bare copper wire for r-f leads and rely upon spacing for insulation. All r-f joints should be soldered, and the joint should be a good mechanical junction before solder is applied. Soldering technique is covered in Chapter 13.

Coil Placement While metal shield baffles are effective in suppressing stray capacitive coupling between circuits, they are not always effective in suppressing inductive coupling. To eliminate all inductive coupling between two coils in inductive relation to each other, each coil should be completely enclosed in an individual shield can, or one coil can be placed above the chassis and the other below. This is not always convenient; so more often the inductive coupling is minimized by orienting the coils for maximum suppression of coupling, and shield baffles are used only to prevent stray capacitive coupling between stages.

For best Q a coil should be in the form of a solenoid approximately as long as its diameter. For minimum interstage coupling, coils should be made as small physically as is practicable. The coils should then be placed so that adjoining coils are oriented for minimum mutual coupling. To determine if this condition exists, apply the following test: the axis of one of the two coils must lie in the plane formed by the center turn of the other coil. If this condition is not met, there is bound to be appreciable coupling unless the unshielded coils are very small in diameter or are spaced a considerable distance from each other.

Variable Capacitors The question of optimum C/L ratio and capacitor plate spacing is covered in Chapter 6. For all-band operation of a high-power stage, it is recommended that a capacitor just large enough for 40-meter c-w operation be chosen. (This will have sufficient capacitance for 'phone operation on all higher frequency bands.) Then use fixed padding capacitors for operation on 80 meters. Such padding capacitors are available in air, gas-filled, and vacuum types.

Specially designed variable capacitors are recommended for

u-h-f work; ordinary capacitors often have "loops" in the metal frame which may resonate near the operating frequency.

Insulation On frequencies above 7 Mc., ceramic, polystyrene, or Mycalex insulation is to be recommended, though hard rubber will do almost as well. Cold flow must be considered when using polystyrene (Victron, Amphenol 912, etc.) or hard rubber. Bakelite has low losses on the lower frequencies but should never be used in the field of high-frequency tank circuits.

Lucite (or Plexiglas), which is available in rods, sheets, or tubing, is excellent for use at all radio frequencies where the r-f voltages are not especially high. It is very easy to work with ordinary tools and is not expensive. The loss factor depends to a considerable extent upon the amount and kind of plasticizer used.

The most important thing to keep in mind regarding insulation is that the best insulation is none at all. If it is necessary to reinforce air-wound coils to keep turns from vibrating or touching, use strips of Lucite or polystyrene cemented in place with Amphenol 912 coil dope. This will result in lower losses than the commonly used celluloid ribs and Duco cement.

Metering The ideal transmitter would have an individual meter in every circuit requiring measurement. However, for the sake of economy, many of us are forced to measure filament and plate voltages by means of a test set or universal meter during the initial tryout of the transmitter, and then assume that these voltages will be maintained. Further economies can be effected by doubling up on meters when measuring current in various circuits in which the current is variable, and as an index of transmitter tuning.

By a system of plugs and jacks, or a selector switch, one or two milliammeters can be used to make all the measurements necessary to tune up a transmitter properly. However, it often is of considerable advantage to be able to observe the current of several circuits or stages simultaneously. Thus the problem boils down to: buy as many meters as you can afford, or as many as the total transmitter investment justifies, purchasing the most necessary meters first. Obviously one would not be justified in buying \$100 worth of meters for a transmitter containing other parts totaling \$75. On the other hand, the purchase of a filament voltmeter to keep careful tab on the filament voltage of a pair of 250-watt tubes is a good investment.

Probably the most popular arrangement calls for meter switching or meter jacks in the low power stages and individual meters in the last stage. Ordinarily, r-f meters are not used except in certain antenna coupling circuits. Where line voltage does not fluctuate appreciably, one can get by very nicely with just d-c milliammeters, plate-current meters in the low power stages, and a grid and a plate meter in the final stage.

Where it is impossible to keep meter or meter leads well away from high r-f voltage or heavy r-f current, d-c meters should be bypassed with small .004 or larger capacitors directly at the meter terminals. The capacitor is placed across the terminals, not from one terminal to ground. Such capacitors are a wise precaution in all cases, because even though meter and meter leads are kept away from r-f components, the meter may be subjected to considerable r-f because of an r-f choke not doing an adequate job of blocking r-f from the meter.

Most meters now come with bakelite cases. If the "zero adjuster" screw is well insulated, such meters can be placed in positive high voltage leads where the voltage does not exceed 1000 volts. When the voltage is higher than 1000 volts, the meter should preferably be placed behind a protective glass. The meter should not be mounted directly on a grounded metal panel when the plate voltage exceeds 2000 volts, as the metal portions of the meter may arc through the bakelite case to the

grounded metal panel, particularly when plate modulation is used.

One highly recommended method of arranging meters in a high-powered rack and panel transmitter is to group all meters on a bakelite meter panel with a glass front at the top of the rack, near eye level of the operator and not close to any of the tuning dials. With the bakelite meter panel, there is no danger of meters arcing to ground, and because of the protection afforded by the glass there is little likelihood of an operator accidentally coming in contact with the meters.

An alternate system is to place all meters in low-voltage circuits directly on the metal panels (assuming meters are of the bakelite case type) and to place the plate milliammeters in all stages having a plate voltage of more than 1000 behind the panel, where they are observed through small windows.

Meter Switching This method can be used to advantage where the voltages on the leads which carry the current to be measured are not greater than about 500 volts to ground. Fifty-ohm resistors are inserted in the leads, and because the resistance of the meter is so low compared to the 50-ohm resistors, the meter can be considered as being inserted in series with the circuit when it is tapped across the resistor. Thus, with a double-pole selector switch having sufficient positions, one can use a single meter to measure the current in several circuits.

The resistor should be made 25 ohms where the current to be measured runs over 200 ma., and the resistor increased to 200 ohms when the current to be measured is less than 15 ma. It is necessary to minimize the resistance where heavy current is present, in order to avoid excessive voltage drop when the meter is not shunting the resistor. It is necessary to increase the value of resistance when the current is so low that a low-range meter must be used to measure the current. Low range milliammeters begin to show appreciable resistance themselves, and their calibration will be thrown off when shunted by too low a value of resistor.

Meter switching is not practicable in high voltage circuits (over 1200 volts). For measuring plate current in high power stages, the resistor should be placed either in the B minus lead or in the filament return (center tap). Placing the meter resistor in the B minus is not practical except when a power supply is used to feed but a single stage, or when heater-type tubes or separate filament transformers are used, as otherwise the meter would indicate total current to all the stages.

Placing the meter in the filament return gives a reading of the total *space current*, which includes both grid current and plate current (and in the case of tetrodes and pentodes, screen current). This point is covered later under *Meter Jacks*.

It is possible, by means of various systems of shunts, to use a single low-range meter for measuring widely different values of current in different circuits, much in the manner of the single-meter test set so popular with servicemen. For instance, a 0-25 ma. meter could be used for measuring grid current in several stages, and then used as a 0-250 ma. instrument when switched into the plate circuit of the final stage by the incorporation of a shunt in the latter circuit to extend the range to 250 ma. Ordinarily, however, a meter is used as a single-scale instrument with this type of switching, a 0-25 ma. meter being used only to read current in circuits carrying up to 25 ma.

Meter Jacks A popular method of using one meter to measure the current in several circuits is to incorporate jacks in the various circuits to be measured. Instead of using low values of resistors across the packs to provide a current path when the meter is not plugged in a circuit, shorting type jacks are used so that when a meter is removed from a jack the circuit is automatically closed.

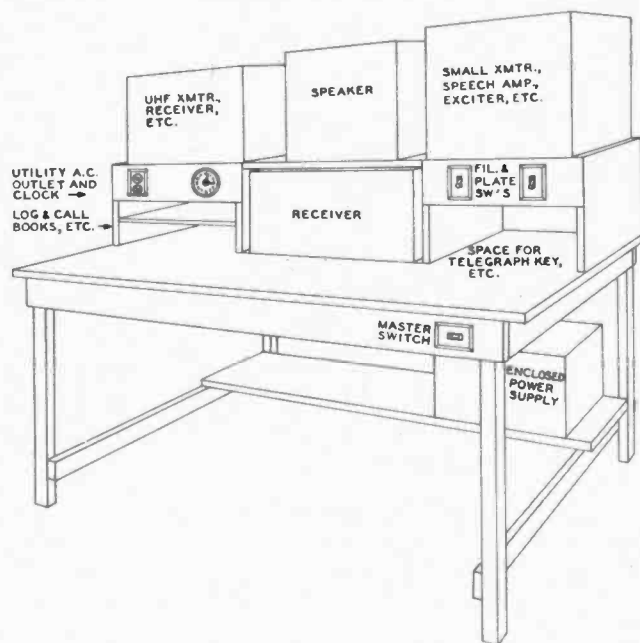

Figure 1.

UTILITY TYPE OPERATING TABLE.

Any amateur handy with a hammer and saw can construct a table of this type with little difficulty and at small cost. If a power supply is placed under the table as shown, it should be housed on the front and top in order to protect the operator from accidental contact with any of the components with his foot. If the equipment supported by the table is especially heavy, the two back legs of the table should be cross braced.

As with meter switching, meter shunts may be placed across certain of the jacks to extend the range of a milliammeter; however, it is more common practice to have a low range meter and a high range meter, and plug the appropriate meter in each circuit.

Meter jacks should not be used except where one side of the circuit can be grounded. This permits one to measure grid current, and, indirectly, plate current. The plate current is ascertained by measuring the current flowing in the filament return and subtracting the grid current (including screen current if the tube has a screen).

A piece of heavily-insulated rubber covered 2-wire cable can be used to connect the meter to the meter plug. If the meter is permanently mounted on the panel, the meter cord should be long enough to reach all meter jacks into which it is to be plugged. To protect low range meters, cathode current jacks in stages drawing heavy current are usually placed in such a position that it is impossible to reach the jack with the cord attached to the low-range meter.

Meter jacks should never be placed in high-voltage leads, and it is inadvisable to use them in any circuit where one side of the jack is not at ground potential. When used for measuring cathode current, the *frame* of the jack should always be grounded, as a defective contact in the jack or a blown meter might otherwise endanger the operator by putting high potential on the meter cord and plug.

A 50-ohm carbon resistor across the terminals of all cathode current meter jacks will not affect the calibration of the meter, yet will protect the operator from possible shock in the event that the meter should blow or the cord open up or come loose on the ground side. In this case, the resistor is more of a protective device than a substitute path for the current when the meter is being used in some other circuit, and little current will flow through the resistor unless the jack, cord, or meter becomes defective.

Mains Supply The problem of supplying the transmitter with alternating current power from the supply mains and turning the transmitter on and off, and "stand-by" while listening, is a problem that can be attacked in many ways, the "best" method being a matter of individual preference. Various suggested methods for transmitter control are described in Section 9-3 of this chapter.

To make sure that an outlet will stand the full load of the entire transmitter, plug in an electric heater rated at about 50 per cent greater wattage than the power you expect to draw from the line. If the line voltage does not drop more than 5 volts (assuming a 117-volt line) under load and the wiring does not overheat, the wiring is adequate to supply the transmitter. About 750 watts total drain is the maximum that should be drawn from a 117-volt "lighting" outlet or circuit. For greater power, a separate pair of heavy conductors should be run right from the meter box. For a 1-kw. phone transmitter the total drain is so great that a 230-volt "split" system ordinarily will be required. Most of the newer homes are wired with this system, as are homes utilizing electricity for cooking and heating.

With a 3-wire system, be sure there is no fuse in the neutral wire at the fuse box. A neutral fuse is not required if both "hot" legs are fused, and, should a neutral fuse blow, there is a chance that damage to the radio transmitter will result.

If you have a high power transmitter and do a lot of operating, it is a good idea to check on your local power rates if you are on a straight "lighting" rate. In some cities a lower rate can be obtained (but with a higher "minimum") if electrical equipment such as an electric heater drawing a specified amount of current is permanently wired in. It is not required that you use this equipment, and many an amateur who runs his kilowatt phone rig far into the night has made a worthwhile saving on his electric bill by scaring up an old 3-kw. air heater at the secondhand store and permanently installing it in the operating room. Naturally, however, there would be no saving unless you expect to occupy the same dwelling for a considerable length of time.

9-3 Transmitter Control Methods

Almost everyone, when first getting a new transmitter on the air, has had the experience of having to throw several switches and pull or insert a few plugs when changing from receive to transmit. This is one extreme in the direction of how *not* to control a transmitter. At the other extreme we find systems where it is only necessary to speak into the microphone or touch the key to change both transmitter and receive over to the transmit condition. Most amateur stations are intermediate between the two extremes in the control provisions and use some relatively simple system for transmitter control such as is shown in Figure 2.

In this system all transmitter tube filaments and possibly the speech-amplifier plate voltage are turned on by means of one primary switch. With this switch on, the transmitter is in "standby" position (as soon as any mercury-vapor rectifiers have once reached operating temperature).

Another switch, the "send-receive" switch S_2 , is connected so as to control all plate transformers except possibly that used for the speech amplifier (which usually is a combined plate-filament transformer). This is perhaps the simplest method, but requires that the modulator and all r-f tubes be supplied from filament windings that are not combined with plate windings on the same core. As this is common transformer practice anyway, except for low-voltage supplies, no special requirements need be considered when purchasing transformers.

The send-receive switch in this system should be capable of handling the required power with considerable to spare, be-

cause of the inductive nature of the load. Thirty ampere mercury switches may be purchased for less than a dollar, and besides having a smooth and positive action, they will last almost indefinitely. They resemble an ordinary house lighting toggle switch in appearance. The latter, costing less than the mercury type, will be found satisfactory in low-powered transmitters.

Another popular arrangement is to use fixed safety bias on the entire transmitter, so that the excitation may be removed at the "front end" of the transmitter without any of the succeeding tubes becoming overheated or going into parasitic oscillation. The transmitter then is turned on and off (or keyed, for that matter) simply by opening and closing the cathode or screen of the oscillator.

To minimize the external wiring, the most common practice is to turn the filaments on right at the transmitter, only the send-receive switch being placed on the operating desk, as in Figure 2. When the transmitter is small and is placed right on or beside the operating desk, both filament and send-receive switches may be placed on the transmitter.

In Figure 4 is shown an arrangement which protects mercury-vapor rectifiers against premature application of plate voltage without resorting to a time-delay relay. No matter which switch is thrown first, the filaments will be turned on first and off last. However, double-pole switches are required in place of the usual single-pole switches. This circuit may be combined with that of Figure 2 simply by taking the primary voltage for all filament transformers from the primary of the rectifier filament transformer shown, and by taking the voltage for the primary of all plate transformers from the primary of the plate transformer as shown in the diagram.

When assured time delay of the proper interval and greater operating convenience are desired, a group of inexpensive a-c relays may be incorporated into the circuit to give a control circuit such as is shown in Figure 5. This arrangement uses a 115-volt thermal (or motor-operated) time-delay relay and a d-p-d-t 115-volt control relay. Note that the protective interlocks are connected in series with the coil of the relay which applies high voltage to the transmitter. A tune-up switch has

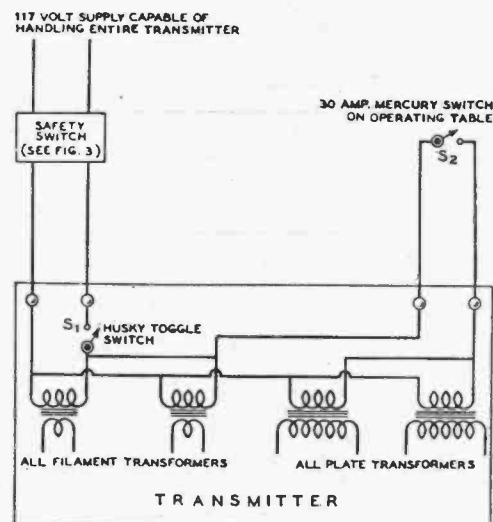

Figure 2.
POPULAR METHOD OF SUPPLYING AND SWITCHING MEDIUM POWER TRANSMITTER.

This arrangement is the one most widely used when the transmitter cannot be reached easily from the operating position. S_2 should never be turned on until S_1 has first been on for 15 seconds, preferably 30 seconds. S_1 should never be turned on except when S_2 is off; thus S_2 should always be turned off before S_1 is turned off.

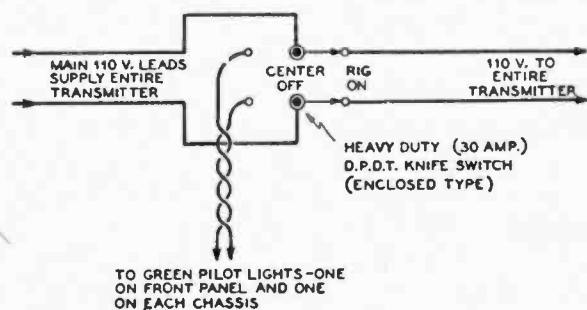

Figure 3.

COMBINED MAIN SWITCH AND SAFETY SIGNAL.

After shutting down the transmitter for the day, throw the main switch to neutral. If you are going to work on the transmitter, throw the switch all the way to "pilot," thus turning on the green pilot lights and making it impossible for primary voltage to be on any transformer in the transmitter even by virtue of a short or accidental ground. To live to a ripe old age, simply obey the rule of "never work on the transmitter unless green lights are on."

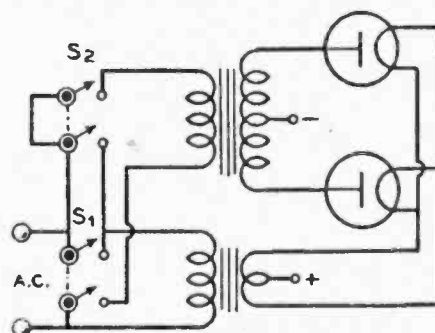

Figure 4.

FOOLPROOF RECTIFIER PROTECTION.

No matter which switch is thrown first, the filaments always will be turned on first and off last. The primaries of other filament transformers are connected in parallel with the primary of the rectifier filament transformer.

been included so that the transmitter may be tuned up as far as the grid circuit of the final stage is concerned before application of high voltage to the final amplifier. Provisions for operating an antenna-changeover relay and for cutting the plate voltage to the receiver when the transmitter is operating have been included.

A circuit similar to that of Figure 5 but incorporating push-button control of the transmitter is shown in Figure 6. The circuit features a set of START-STOP and TRANSMIT-RECEIVE buttons at the transmitter and a separate set at the operating position. The control push buttons operate independently so that either set may be used to control the transmitter. It is only necessary to push the START button momentarily to light the transmitter filaments and start the time-delay relay in its cycle. When the standby light comes on it is only necessary to touch the TRANSMIT button to put the transmitter on the air and disable the receiver. Touching the RECEIVE button will turn off the transmitter and restore the receiver. After a period of operation it is only necessary to touch the STOP button at either the transmitter or the operating position to shut down the transmitter. This type of control arrangement is called an electrically-locking push-to-control system. Such systems are frequently used in industrial electronic control.

Several additional types of transmitter control circuits are shown in Chapters 25 and 26, *Power Supplies and Transmitter Construction*. In addition, a transmitter control circuit of considerable versatility is included in the "AN/ART-13 Reconversion" described in Chapter 32. The c-w operation control circuit shown is of particular interest and operates in the following manner:

1. The transmitter is turned on and warmed up.
2. When it is desired to transmit it is necessary only to start keying. The first instant the key closes all the power supplies are turned on, the receiver antenna is disconnected, and if desired the receiver plate supply may be turned off.
3. In a predetermined interval after the last character has been transmitted (adjustable from 0.1 second to 15 seconds) the plate supplies are turned off and the operation of the receiver is restored.

The particular transmitter control feature just described may of course be used with any type of transmitter. The essential parts of the circuit are the small receiver power transformer, a 6X5 and a 6C5 tube, a sensitive relay and a keying relay, and a few capacitors and resistors. A small choke is also used in the click filter.

9-4**Safety Precautions**

The best way for an operator to avoid serious accidents from the high voltage supplies of a transmitter is for him to use his head, act only with deliberation, and not take unnecessary chances. However, no one is infallible, and chances of an accident are greatly lessened if certain factors are taken into consideration in the design of a transmitter, in order to protect the operator in the event of a lapse of caution. If there are too many things one must "watch out for" or keep in mind there is a good chance that sooner or later there will be a mishap; and it only takes *one*. When designing or constructing a transmitter, the following safety considerations should be given attention.

Grounds For the utmost in protection, everything of metal on the front panel of a transmitter capable of being touched by the operator should be at ground potential. This includes dial set screws, meter "zero adjuster" screws, meter cases if of metal, meter jacks, *everything* of metal protruding through the front panel or capable of being touched or nearly touched by the operator. This applies whether or not the panel itself is of metal. Do not rely upon the insulation of meter cases or tuning knobs for protection.

The B negative or chassis of all plate power supplies should be connected together, and to an external ground such as a waterpipe. In the case of a bias supply, the B positive should be connected to the common ground.

Exposed Wires and Components It is not necessary to resort to rack and panel construction in order to provide complete enclosure of all components and wiring of the transmitter. Even with breadboard construction it is possible to arrange things so as to incorporate a protective housing which will not interfere with ventilation yet will prevent contact with all wires and components carrying high voltage d.c. or a.c.

If everything on the front panel is at ground potential (with respect to external ground) and all units are effectively housed with protective covers, then there is no danger except when the operator must reach into the interior part of the transmitter, as when changing coils, neutralizing, adjusting coupling, or shooting trouble. The latter procedure can be made safe by making it possible for the operator to be *absolutely certain* that all voltages have been turned off and that they cannot be turned on either by short circuit or accident. This can be done by incorporation of the following system of main primary switch and safety signal light.

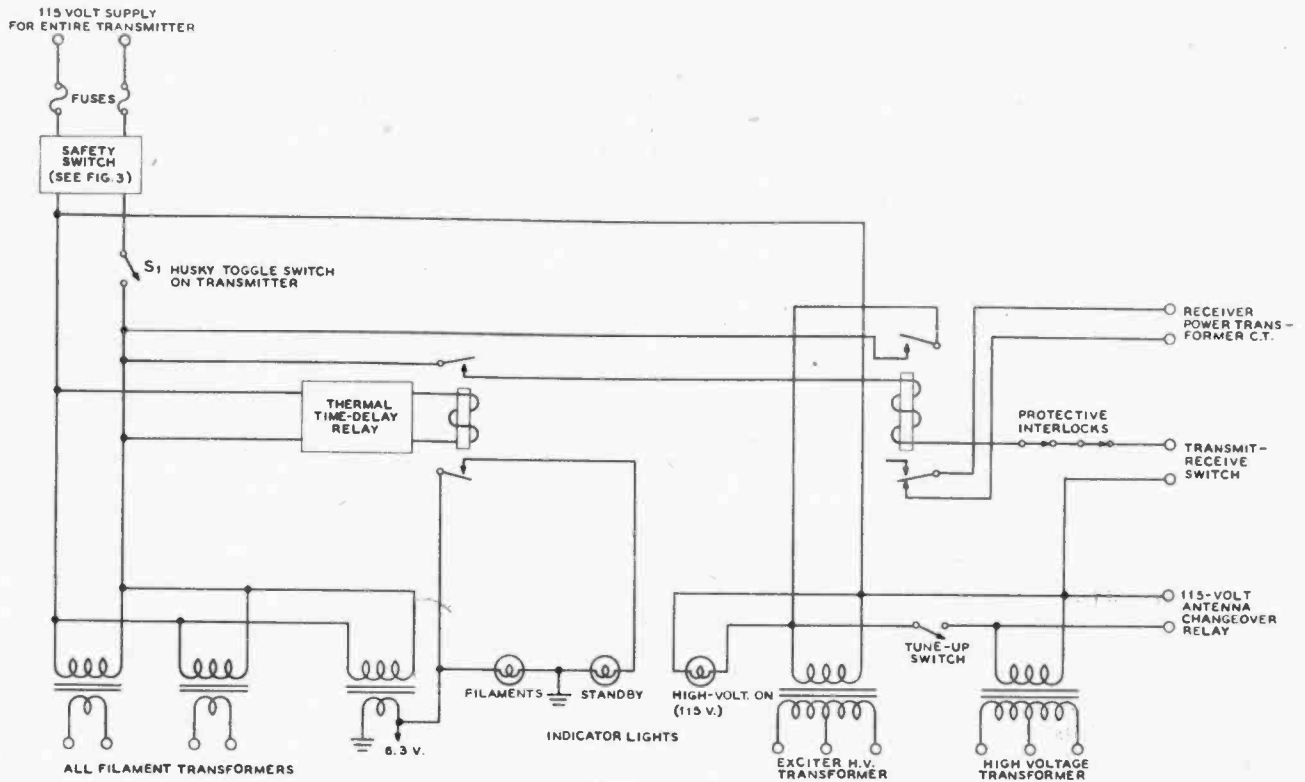

Figure 5.
TRANSMITTER CONTROL CIRCUIT.

Closing S₁ lights all filaments in the transmitter and starts the time-delay relay in its cycle. When the time-delay relay has operated closing the transmit-receive switch at the operating position will apply plate power to the transmitter and disable the receiver. A tune-up switch has been provided so that the exciter stages may be tuned without plate voltage on the final amplifier. The safety circuit of Figure 3 has been incorporated.

Combined Safety Signal and Switch The common method of using red pilot lights to show when a circuit is "on" is useless except from an ornamental standpoint. When the red pilot is not lit it usually means that the circuit is turned off, but it can mean that the circuit is on but the lamp is burned out or not making contact.

To enable you to grab the tank coils in your transmitter with absolute assurance that it is impossible for you to obtain a shock except from possible undischarged filter condensers (see following topic for elimination of this hazard), it is only necessary to incorporate a device similar to that of Figure 3. It is placed near the point where the main 110-volt leads enter the room (preferably near the door) and in such a position as to be inaccessible to small children. Notice that this switch breaks both leads; switches that open just one lead do not afford complete protection, as it is sometimes possible to complete a primary circuit through a short or accidental ground. Breaking just one side of the line may be all right for turning the transmitter on and off, but when you are going to stick an arm inside the transmitter, both 110-volt leads should be broken.

When you are all through working your transmitter for the time being, simply throw the main switch to neutral. Then you can leave the transmitter and even go on a vacation with absolute peace of mind.

When you find it necessary to work on the transmitter or change coils, throw the switch so that the green pilots light up. These can be ordinary 15-watt green bulbs. One should be placed on the front panel of the transmitter; others should be placed so as to be easily visible when changing coils or making adjustments requiring the operator to reach inside the transmitter. These lamps are inexpensive, and as several will draw

less than 100 watts from the line, a half dozen may be scattered around the transmitter.

For 100 per cent protection, just obey the following rule: never work on the transmitter or reach inside any protective cover except when the green pilots are glowing. To avoid confusion, no other green pilots should be used on the transmitter, if you want an indicator jewel to show when the filaments are lit, use amber instead of green.

If the main switch is out of reach of small children, a conspicuous sign, such as "DO NOT TOUCH UNDER ANY CIRCUMSTANCES," placed on the switch cover will guard against the off chance that someone else would throw the switch unexpectedly. An alternative is to place the switch on the under side of the operating table out of sight. The latter is not so desirable when small children have access to the room.

Safety Bleeders High-capacity filter capacitors of good quality hold their charge for some time, and when the voltage is more than 1000 volts it is just about as dangerous to get across an undischarged 4- μ fd. filter capacitor as it is to get across a high-voltage supply that is turned on. Most power supplies incorporate bleeders to improve regulation, but as these are generally wire-wound resistors, and as wire-wound resistors occasionally open up without apparent cause, it is desirable to incorporate an auxiliary safety bleeder across each heavy-duty bleeder. Carbon resistors will not stand much dissipation and sometimes change in value slightly with age. However, the chance of their opening up when run well within their dissipation rating is very small.

To make sure that all capacitors are bled, it is best to short each one with an insulated screwdriver. However, this is sometimes awkward and always inconvenient. One can be virtually

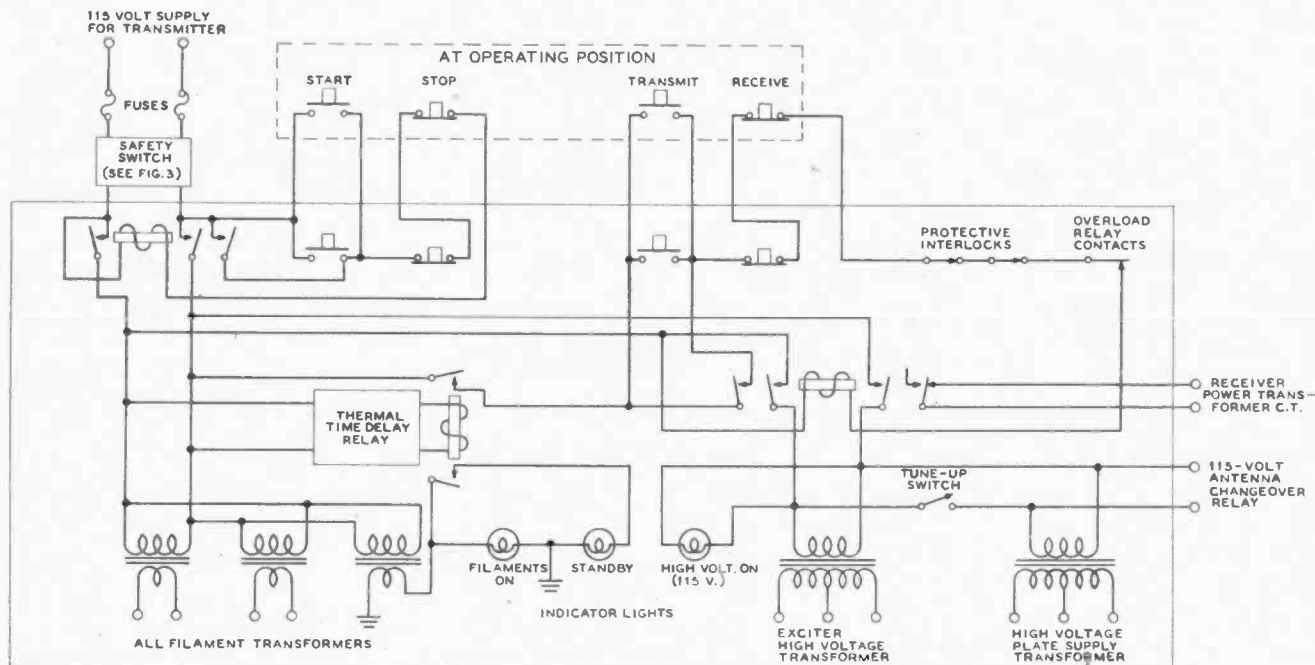

Figure 6.
PUSH-BUTTON TRANSMITTER-CONTROL CIRCUIT.

Pushing the **START** button either at the transmitter or at the operating position will light all filaments and start the time-delay relay in its cycle. When the cycle has been completed, a touch of the **TRANSMIT** button will put the transmitter on the air and disable the receiver. Pushing the **RECEIVE** button will disable the transmitter and restore the receiver. Pushing the **STOP** button will instantly drop the entire transmitter from the a-c line. If desired, a switch may be placed in series with the lead from the **RECEIVE** button to the protective interlocks; opening this switch will make it impossible for any person accidentally to put the transmitter on the air. Various other safety provisions, such as the protective-interlock arrangement described in the text and the circuit of Figure 3 have been incorporated.

With the circuit arrangement shown for the overload-relay contacts, it is only necessary to use a simple normally-closed d-c relay with a variable shunt across the coil of the relay. When the current through the coil becomes great enough to open the normally-closed contacts the hold-circuit on the plate-voltage relay will be broken and the plate voltage will be removed. If the overload is only momentary, such as a modulation peak or a tank flashover, merely pushing the **TRANSMIT** button will again put the transmitter on the air. This simple circuit provision eliminates the requirement for expensive overload relays of the mechanically-latching type, but still gives excellent overload protection.

sure by connecting auxiliary carbon bleeders across all wire-wound bleeders used on supplies of 1000 volts or more. For every 500 volts, connect in series a 500,000-ohm 1-watt carbon resistor. The drain will be negligible (1 ma.) and each resistor will have to dissipate only 0.5 watt. Under these conditions the resistors will last indefinitely with little chance of opening up. For a 1500-volt supply, connect three 500,000-ohm resistors in series. If the voltage exceeds an integral number of 500 volt divisions, assume it is the next higher integral value; for instance, assume 1800 volts as 2000 volts and use four resistors.

Do *not* attempt to use fewer resistors by using a higher value for the resistors; not over 500 volts should appear across any single 1-watt resistor.

In the event that the regular bleeder opens up, it will take several seconds for the auxiliary bleeder to drain the capacitors down to a safe voltage, because of the very high resistance. Hence, it is best to allow 10 or 15 seconds after turning off the plate supply before attempting to work on the transmitter.

"Hot" Adjustments Some amateurs contend that it is almost impossible to make certain adjustments, such as coupling and neutralizing, unless the transmitter is running. The best thing to do is to make all neutralizing and coupling devices adjustable from the front panel by means of flexible control shafts which are broken with insulated couplings to permit grounding of the panel bearing.

If your particular transmitter layout is such that this is impracticable and you refuse to throw the main switch to make

an adjustment—throw the main switch—take a reading—throw the main switch—make an adjustment—and so on, then protect yourself by making use of long adjusting rods made from 1/2-inch dowel sticks which have been wiped with oil when perfectly free from moisture.

If you are addicted to the use of pickup loop and flashlight bulb as a resonance and neutralizing indicator, then fasten it to the end of a long dowel stick and use it in that manner.

Protective Interlocks With the increasing tendency toward construction of transmitters in enclosed steel cabinets a transmitter becomes a particularly lethal device unless adequate safety provisions have been incorporated. Even with a combined safety signal and switch as shown in Figure 3 it is still conceivable that some person unfamiliar with the transmitter could come in contact with high voltage. It is therefore recommended that the transmitter, wherever possible, be built into a complete metal housing or cabinet and that *all* doors or access covers be provided with protective interlocks (all interlocks must be connected in *series*) to remove the high voltage whenever these doors or covers are opened. The term "high voltage" should mean any voltage above approximately 150 volts, although it is still possible to obtain a serious burn from a 150-volt circuit under certain circumstances. The 150-volt limit usually will mean that grid-bias packs as well as high-voltage packs should have their primary circuits opened when any interlock is opened.

Transmitter Adjustment

WHILE there are as many different tuning procedures as there are types of transmitters, there are certain general rules which should be followed regardless of the type of transmitter. Also, there are certain initial checks that should be made on the transmitter when it is first "fired up," regardless of the type. A sequence of ten such checks is given in the following section.

10-1 Initial Transmitter Tune-Up

In making the initial adjustments upon a new transmitter it is recommended that an orderly procedure be followed in checking out first the simpler circuits and then proceeding to the more complex stages so that it will be known, as soon as difficulties are encountered, that all the simpler circuits are operating properly. It is suggested that the following steps be followed, wherein they apply, in checking a transmitter for proper operation the first time it is tuned up, or for that matter, the first time it is operated after a long period of inactivity.

1. Check Filament and Heater Voltages Apply line voltage to the transmitter and make sure that all the plate supplies and bias power supplies are completely disconnected from the line. Check the filament or heater voltage of each tube in the transmitter with a voltmeter whose accuracy has been checked. When checking a-c voltages it is best to use an instrument of the iron-vane type since rectifier-type instruments often are far out of calibration on the low-voltage ranges when they have not been checked for a long period of time. All filament and heater voltages should be checked directly at the *socket* terminals.

It is best to adjust filament-transformer primary taps and drop resistors (if used) so that the filament voltage actually at the socket is about 5 per cent *above* the rated value. This procedure is recommended since the line voltage to a transmitter will usually drop from 3 to 8 per cent when plate power is applied—unless, of course, a special low-drop line has been run in to operate the transmitter.

Heater-cathode tubes such as the 6L6, 807, 2E26 and similar types can be operated over a plus or minus 10 per cent range in heater voltage above and below the rated value. However, it is best to operate tubes of this type at least within 5 per

cent of the rated voltage. Directly-heated or filament tubes such as the great majority of transmitting tubes and rectifiers can be operated 5 per cent above or below rated voltage but is best to operate these types within a few per cent of the rated value. This applies particularly to low-voltage high-current tubes such as the Eimac and HK types and the RCA 806. This limitation in voltage tolerance applies also to rectifier tubes such as the 816, 866A/866, and 872A/872.

2. Check Control Circuits, Plate and Bias Supplies All control circuits, time-delay relays, interlocks, and overload provisions should be checked to make sure that all switches control the circuits they were intended to control, and that the transmitter is safe to operate with the control provisions that have been made.

No-load voltages of the various plate and bias supplies should be checked with a high-resistance voltmeter to make sure that these voltages are within the expected range. No-load voltages on plate supplies having a capacitor-input filter can be expected to be from 40 to 50 per cent high. No-load voltage output of a supply having a choke-input filter, however, should be not more than about 10 or 15 per cent above the expected operating value. If the voltage output of a choke-input power supply *does* soar, it means that the maximum inductance of the input swinging choke is not sufficiently high or that the value of bleeder resistance used is too great. If the voltage output of a choke-input supply is excessive with no load the input inductance must be increased to the critical value of $R/1000$ henries, where R is the value of the bleeder resistor, or the bleeder resistor value may be reduced to such an amount that the above expression is satisfied with the input choke in use. The inductance of a swinging choke can often be increased by removing some of the material in the air gap of the core. This subject is covered in Chapter 25, *Power Supplies*.

Satisfactory operation of the bleeder resistors on each of the power supplies may be checked by shorting a screwdriver across one of the filter capacitors of the power supply after the power transformer has been turned off for 15 or 20 seconds. Make sure that the metal shaft of the screwdriver is grounded and then touch the *grounded* shaft of the screwdriver to the hot terminal of the filter capacitor. If there is any spark left in the filter capacitors after 15 or 20 seconds the bleeder

resistor across the power supply is not operating properly. Another method of checking bleeder operation is to connect a high-resistance voltmeter to the supply, apply plate voltage for a moment, and then note the rate at which the voltage decreases to zero. If the voltage falls very gradually after the plate transformer has been removed from the line, *beware*, and wait for all the charge to drain from the capacitors as indicated by the voltmeter indication dropping to zero before working on the supply. Then short the filter capacitors with a screwdriver, and apply a clip lead across one of the filter capacitors before working on the rewiring. *Do not* attempt to drain the charge on the filter capacitors of a high-voltage supply with a defective bleeder with a screwdriver—the resulting outrush of current will certainly damage the screwdriver, the procedure is very dangerous, and the filter capacitors may be damaged.

The easiest way to make a first check on the presence of a bleeder of correct value on a power supply is to remove completely the power plug going to the supply, short one of the filter capacitors with an insulated screwdriver, remove all output leads from the power supply, remove the screwdriver, and check for resistance with an ohmmeter across one of the filter capacitors. The resistance value noted should be the value of the bleeder resistor across the power supply.

3. Check First R-F Stage in Transmitter The first r-f stage in a transmitter will normally be either a crystal oscillator stage or the first tuned stage following the v-f-o. The operation of a crystal oscillator depends to a great extent upon the activity of the crystal, and the activity varies widely with different crystals. The oscillator should be tuned for the greatest output or lowest plate current which will provide strong, stable oscillations. An attempt to adjust the oscillator for every last milliwatt of output will result in the crystal's not starting "cleanly" each time the plate voltage is applied or the key is pressed. A receiver or monitor will be required for this check, during which a check also should be made on the frequency.

The first time the crystal oscillator is operated a check also should be made upon the r-f crystal current (unless the oscillator is run at very low screen and plate voltages) to make sure that it is not excessive at any setting of the plate tuning capacitor.

If the first r-f stage in the transmitter is fed from a v.f.o. the stage should be excited from the v.f.o. and the plate tank tuned to resonance with the aid of a dial lamp and a loop of wire or the grid current on the next stage. A wavemeter should be used to make sure that the stage is being tuned to the correct frequency. The plate tank of the stage should then be tuned through its full range while listening on a receiver to make sure that the stage does not self-oscillate at any tank capacitor setting.

4. Tune Successive Stages to Final-Amplifier Grid Each stage following the crystal oscillator or v-f-o amplifier should then be tuned to resonance with the aid of a wavemeter and the grid and plate milliammeters on the stages. If there are any neutralized stages in the chain these should be neutralized in accordance with the procedure given in Chapter 6, *Generation of R-F Energy*. Make sure that adequate grid current is obtainable on the final amplifier stage on each of the bands on which the exciter has been designed to operate. The operating currents and voltages on grids, plates, and screens of each of the exciter stages should be measured to make sure that they are within the rated values for the tube types concerned. If they are not, alter the resistor values in the various feed circuits until voltages and currents are within ratings.

5. Neutralize Final Amplifier The recommended procedure for amplifier neutralization has been covered in Chapter 6. Triode amplifier stages will always require neutralization unless the grounded-grid or cathode-follower circuit has been used. Even then the stage *may* require neutralization. Beam-tetrode and pentode stages will frequently require neutralization, although neutralization is less frequently required with pentodes than with tetrodes. A very small value of neutralizing capacitance will be required when neutralizing tetrodes or pentodes.

6. Operate Final Amplifier into Dummy Load Apply reduced plate voltage to the final amplifier and couple the stage to a dummy load. Reduced plate voltage may be obtained from the final plate supply by connecting the primary of the transformer for half voltage if the taps are available, it may be obtained by running the final stage from one of the buffer plate supplies, or reduced voltage may be obtained by connecting a lamp or screw-base heater element in series with the primary of the plate transformer.

The dummy load may consist of Ohmite Dummy Antenna Resistors, Sprague non-inductive resistors of appropriate resistance and wattage, or it may consist simply of a number of ordinary 115-volt lamps.

When using ordinary 115-volt lamps it has been found wise to use somewhat more lamp wattage than the expected output of the transmitter. If this is not done, difficulty may be encountered in the case of high-power transmitters with dielectric breakdown in the base or the stem of the lamp. Nine 200-watt lamps connected three in series and three groups in parallel has been found to operate satisfactorily on a 1-kilowatt transmitter. But a single 1000-watt lamp will break down in the base after a short period of operation at amateur frequencies.

The coupling to the dummy load should be adjusted so that the plate current to the stage bears the same ratio to the desired plate current as does the test plate voltage to the plate voltage at which the stage is to be operated. When this adjustment has been made, full plate voltage may be applied, *carefully*, to the final amplifier stage. When all stages seem to be operating correctly, the transmitter may be checked for parasitic oscillations. Of course, it is quite possible that stable operation has not been obtained up to this stage in the tune-up procedure, so that parasitic oscillations must have been eliminated before the final amplifier stage has been reached.

7. Checking for Parasitic Oscillations It is an unusual transmitter which harbors no parasitic oscillations when first constructed and tested. Hence it is always wise to follow a definite procedure in checking a new transmitter for parasitic oscillations. Parasitic oscillations (as distinguished from self-oscillation on the tuned frequency of the amplifier) ordinarily occur in two types: low-frequency parasitics from 20 to 200 or 300 kc., and high-frequency parasitics from 40 to 200 Mc. Low-frequency parasitics can easily be detected by the fact that they will modulate the carrier frequency of the transmitter producing strong sidebands, usually of rough tone, on either side of the carrier frequency and spaced from it and from each other by the parasitic oscillation frequency. Thus if the transmitter carrier is on 14.1 Mc. and the parasitic oscillation frequency is 100 kc. the spurious sidebands will be heard at 13.9, 14.0, 14.2, 14.3, 14.4 Mc. and so on either side of the carrier.

High-frequency or v-h-f parasitics on the other hand usually cause a roughening of the carrier signal of the transmitter but must be tuned in on a v-h-f receiver to be heard. A systematic procedure for determining the presence or absence of parasitic oscillations is given in the following paragraphs.

a. Tune a communications receiver about 20 kc. or 30 kc. to one side or the other of the carrier frequency of the transmitter.

b. Apply plate voltage to the stage being checked and detune first the plate tank and then the grid tank as far either side of resonance as can be done without exceeding the plate dissipation rating of the tube or tubes in the stage. It is wise to have a resistor in series with the primary of the plate transformer of a high-power amplifier stage so that the plate voltage will drop when the plate current increases.

c. If there are no sudden jumps in either the grid current or the plate current of the stage, and if no spurious signals can be heard with any tuning adjustment of the stage on the receiver when tuned from the carrier to several hundred kilocycles either side, it can be assumed that there are no low-frequency parasitics present. Also, if the plate and grid currents behave in an orderly manner it is probable that v-h-f parasitics are not present. However, it is still wise to listen on a v-h-f receiver covering the range from 28 to perhaps 150 Mc. (if such a receiver is available) to make sure that parasitics in this frequency range are not present. Parasitic oscillations can almost always be detected on a v-h-f receiver by the fact that their tone will be rough and unstable as compared to the clean and stable tone that normal harmonics of the carrier frequency will have.

If parasitic oscillations are found they should be eliminated by the procedure discussed in Section 10-3 of this chapter. If parasitic oscillations are not found, or after they have been eliminated, it is then possible to apply full power to the transmitter and check its modulation or keying while operating into the dummy load.

8. Check Modulation or Keying The transmitter should now be operated at full power and modulated or keyed in the manner normally to be employed. Again it is convenient to check for key clicks or spurious sidebands under modulation by means of a communications receiver tuned either to one side or the other of the carrier frequency of the transmitter. Further check for parasitic oscillations under modulation or keying should be made. A discussion of the treatment of key clicks and spurious sidebands due to modulation has been given in Chapter 7, *Amplitude Modulation and Keying*.

9. Checking on Other Bands After the transmitter has been checked out completely with the energy fed into a dummy antenna on one band, the dial settings for all the tuning controls should be noted and the transmitter shifted to another frequency in another amateur band on which it is desired to operate. The procedure given before should be followed and when satisfactory operation has been obtained on that band the dial settings should again be noted and operation shifted to another band. After it has been determined that satisfactory operation can be obtained on all the bands in which it is desired to operate the transmitter it is well to give the equipment a heat run of moderate duration.

10. Making a Heat Run on the Equipment It is always wise to make a short life test or heat run on a new transmitter to make sure that the operating conditions of the transmitter will remain stable over a period of time and to determine whether or not any components are experiencing excessive heating as a result of their normal operation. For the first test the transmitter should be run for perhaps 10 minutes into a dummy load—with key down if the rig is a c-w transmitter and with about 60 per cent sine-wave modulation if the transmitter is to be used

with amplitude modulation. After the first 10-minute test the transmitter should be shut down, the connection to the 115-volt line completely severed, the filter capacitors shorted with a screwdriver, and the various components felt cautiously with the hand to determine whether or not excessive heating has taken place. The bleeder resistors should be quite warm (if they are not it is possible that they are open) but the other components except for occasional resistors should not be too hot to touch.

If the equipment passes the 10-minute run without trouble the equipment should be operated for about 30 minutes and the check again made. After this test the equipment should be left on for about 1 hour. Many components designed for amateur transmitters (particularly inexpensive plate transformers and chokes) are designed for not more than about 1 hour continuous duty. This design limitation is usually satisfactory for amateur operation since an amateur transmitter is almost invariably standing by a somewhat greater percentage of the time than it is transmitting. Most components of the size usually employed in amateur transmitters will reach their ultimate temperature after a continuous run of approximately one hour. However, if any components show signs of dangerous heating (but not actually excessive) it is probably best to operate the transmitter again for an additional half-hour period to determine whether the component will remain in operation. It is better to find that a component is inadequate while testing a transmitter than to have it break down while the equipment is being used in a contest.

Transformers and chokes are usually operating satisfactorily insofar as heating is concerned if they are a little too hot to hold the hand in contact with after such a period of operation. Filter capacitors should remain as cool as the ambient temperature of the air within the transmitter enclosure. Mica capacitors may run warm but certainly not far above body temperature.

10-2 Amplifier Adjustment

Plate Circuit Tuning After an amplifier is completely neutralized, reduced plate voltage should be applied before any load is coupled to the amplifier. This reduction in plate voltage should be at least 50 per cent of normal value, because the plate current will rise to excessive values when the plate tuning capacitor is not adjusted to the point of resonance as indicated by the greatest dip in reading of the d-c plate current milliammeter. The r-f voltage across the plate circuit is greatest at this point.

With no load, the r-f voltage may be several times as high as when operating under conditions of full load; this may result in capacitor flashover if normal d-c voltage is applied. The no-load plate current at resonance should dip to roughly 15 per cent of normal value. If the plate circuit losses are excessive, or if *parasitic oscillations* are taking place, the no-load plate current will be higher.

Loading The load (antenna or succeeding r-f stage) then can be coupled to the amplifier under test. The coupling can be increased until the plate current at resonance (greatest dip in plate current meter reading) approaches the normal values for which the tube is rated. The value at reduced plate voltage should be proportionately less in order to prevent excessive plate current load when normal plate voltage is applied. Full plate voltage should not be applied to an amplifier unless the r-f load also is connected; otherwise the tuning capacitors may arc or flash over, thereby causing an abnormally high plate current which may damage the tube. The tuned circuit impedance is lowered when the amplifier is loaded, as are the r-f voltages across the plate and neutralizing capacitors.

Grid Excitation Excessive grid excitation is just as injurious to a vacuum tube as abnormal plate current or low filament voltage. Too much grid driving power will overheat the grid wires in the tube, and will cause a release of gas in certain types of tubes. An excess of grid drive will not appreciably increase the power output and can increase the efficiency only slightly. The grid current in the tube should not exceed the values listed in the *Tube Tables*, and care also should be exercised to have the bias voltage low enough to prevent flashover in the stem of the vacuum tube.

Grid excitation usually refers to the actual r-f power input to the grid circuit of the vacuum tube, part of which is used to drive the tube, and part of which is lost in the C-bias supply. There is no way to avoid wasting a portion of the excitation power in the bias supply. The loss is the same with battery bias as with grid-leak bias.

It is natural that the grid current to an amplifier stage should fall off considerably with application of plate voltage, the drop in grid current becoming greater as the loading and plate current on the stage are increased. If the excitation is adjusted for maximum permissible grid current with the tubes loaded, this value will be exceeded when the plate voltage or load is removed, particularly when no grid-leak bias is employed. However, under these conditions, the grid impedance drops to such a low value that the high value of grid current represents but little increase in power, and there is little likelihood that the tube will be damaged unless the grid current increases to more than twice its rated maximum.

Tuning Under Load Amplifier stages always should be tuned for maximum output. This does not mean that the coupling must be adjusted until the stage will deliver the maximum power of which it is capable, but that the tank tuning capacitor always should be adjusted to the setting which permits maximum output. If the stage is not heavily loaded, this will correspond closely to minimum plate current. However, if the two do not correspond exactly, the stage should be tuned for maximum output rather than minimum plate current. If the difference is appreciable, especially in that amplifier which feeds the antenna, the amplifier should be redesigned to utilize a higher value of tank capacitance.

Screen-grid tubes never should be operated with full screen voltage when the plate voltage is removed, as the screen dissipation will become excessive and the tube may be permanently damaged. Neither should screen-grid and beam-tetrode amplifier stages be operated with plate voltage applied and without load since the screen current may also become very high under such conditions unless some provision has been made, such as a resistor in the screen series circuit, to limit the screen current.

When all stages are operating properly, the filament voltage on all tubes should be checked to make sure that it is neither excessive nor deficient, one being about as bad as the other. Unless the line voltage varies at least several volts throughout the day, filament meters are not required on all stages of a multi-stage transmitter. An initial check when the transmitter is put into operation for the first time is sufficient; after that a single filament meter permanently wired across the filament or filaments of the final amplifier stage will be sufficient. If the filament voltage reads high on that stage, it can be assumed to be high on all stages if the filament voltages were adjusted correctly in the first place. Filament voltage always should be measured *right at the tube socket*.

10-3 Elimination of Parasitic Oscillations

Parasitic oscillations in transmitter stages are of such varying types, frequencies, and amplitudes that it is very difficult to set forth a definite procedure to be followed in attempting

to eliminate them. However, a number of general suggestions will be made, and the applicability to the particular case at hand will have to be determined by the person who has tackled the task of parasitic elimination.

It may be said in general that low-frequency parasitics must include somewhere in the oscillating circuit an impedance which is high at a frequency that is high in the upper audio or low r-f range. This impedance may include one or more r-f chokes of the conventional variety, power supply chokes, modulation components, or the high impedance may be presented simply by an RC circuit such as might be found in the screen-feed circuit of a beam-tetrode amplifier stage. The presence of low-frequency parasitics is easily determined by the method discussed in paragraph 7 of Section 10-1 earlier in this chapter.

The most usual source of low-frequency parasitics is the presence of an r-f choke in both the grid circuit and plate circuit of an amplifier. Hence, if such parasitics are encountered it is best to replace first the plate r-f choke by a resistor (or by a tuned circuit if the stage is shunt fed) and then the grid r-f choke by a resistor, checking in each case on both sides of the carrier for some distance to determine whether or not the parasitic has been eliminated. If this expedient does not eliminate the condition, and the stage under investigation uses a beam-tetrode tube, negative resistance can exist in the screen circuit of such tubes. Try larger and smaller screen by-pass capacitors to determine whether or not they have any effect. If the condition is coming from the screen circuit an audio choke with a resistor across it in series with the screen feed lead will often eliminate the trouble.

Low-frequency parasitic oscillations can often take place in the audio system of an AM transmitter, and their presence will not be known until the transmitter is checked on a receiver. It is easy to determine whether or not the oscillations are coming from the modulator simply by switching off the modulator

FREQUENCIES WHOSE HARMONICS FALL IN THE H-F AND V-H-F BANDS

ELEVEN-METER BAND		SIX-METER BAND	
3.395	× 8 = 27.160	3.125	× 16 = 50.0
3.400	× 8 = 27.200	3.15625	× 16 = 50.5
3.4125	× 8 = 27.300	3.1875	× 16 = 51.0
3.425	× 8 = 27.400	3.21875	× 16 = 51.5
3.435	× 8 = 27.480	3.250	× 16 = 52.0
		3.28125	× 16 = 52.5
		3.3125	× 16 = 53.0
		3.34375	× 16 = 53.5
		3.375	× 16 = 54.0
TEN-METER BAND			
3.500	× 8 = 28.0	6.250	× 8 = 50.0
3.53125	× 8 = 28.25	6.3125	× 8 = 50.5
3.5625	× 8 = 28.5	6.375	× 8 = 51.0
3.59395	× 8 = 28.75	6.4375	× 8 = 51.5
3.625	× 8 = 29.0	6.50	× 8 = 52.0
3.65625	× 8 = 29.25	6.5625	× 8 = 52.5
3.6875	× 8 = 29.5	6.625	× 8 = 53.0
3.7125	× 8 = 29.7	6.6875	× 8 = 53.5
		6.750	× 8 = 54.0
7.0	× 4 = 28.0	8.33333	× 6 = 50.0
7.0625	× 4 = 28.25	8.41666	× 6 = 50.5
7.125	× 4 = 28.5	8.50	× 6 = 51.0
7.1879	× 4 = 28.75	8.58333	× 6 = 51.5
7.25	× 4 = 29.0	8.70	× 6 = 52.0
7.3125	× 4 = 29.25	8.75	× 6 = 52.5
7.375	× 4 = 29.5	8.8333	× 6 = 53.0
7.425	× 4 = 29.7	8.9166	× 6 = 53.5
		9.0	× 6 = 54.0

tubes. If the oscillations are coming from the modulator, the stage in which they are being generated can be determined by removing tubes successively, starting with the first speech amplification stage, until the oscillation stops. When the stage has been found, remedial steps can be taken on that stage.

If the stage causing the oscillation is a low-level speech stage it is possible that the trouble is coming from power-supply feedback, or it may be coming about as a result of inductive coupling between two transformers. If the oscillation is taking place in a high-level audio stage, it is possible that inductive or capacitive coupling is taking place back to one of the low-level speech stages. It is also possible, in certain cases that parasitic push-pull oscillation can take place in a Class B or Class AB modulator as a result of the grid-to-plate capacitance within the tubes and in the stage wiring. This condition is more likely to occur if capacitors have been placed across the secondary of the driver transformer and across the primary of the modulation transformer to act in the reduction of the amplitude of the higher audio frequencies. Relocation of wiring or actual neutralization of the audio stage in the manner used for r-f stages may be required.

In general, however, low-frequency parasitics are comparatively easy to find and easy to eliminate since their frequency is most frequently far removed from the carrier frequency of the transmitter and from any frequency it is desired to transmit.

V-h-f parasitics, on the other hand, are often difficult to locate and quite difficult to eliminate since their frequency is often only moderately above the upper frequency it is desired to transmit. Beam-tetrode stages, particularly those using 807 tubes, will almost invariably have one or more v-h-f parasitics unless adequate precautions have been taken in advance. Many of the units described in Part II, *Construction of Radio Equipment*, of this book had parasitic oscillations when first constructed. But these oscillations were eliminated in each case and the expedients used in these equipments should be studied.

It is most desirable to be able to determine the frequency of a parasitic oscillation in the v-h-f range. This is often difficult, however, unless a receiver covering the range up to 300 Mc. or so is available. For most purposes, however, a receiver such as the National 1-10A or the Hallicrafters SX-42, S-36, or AN/ARR-5 which go at least to 110 Mc. will be of great assistance. However, if such a receiver is not available it will be necessary to attack the oscillation somewhat blindly.

In the case of triodes, v-h-f parasitic oscillations usually come about as a result of inductance in the neutralizing leads. This is particularly true in the case of push-pull amplifiers. The cure for this effect will usually be found in reducing the length of the neutralizing leads and increasing their diameter. Both the reduction in length and increase in diameter will reduce the inductance of the leads and tend to raise the parasitic oscillation frequency until it is out of the range at which the tubes will oscillate. The use of straightforward circuit design with short leads will assist in forestalling this trouble at the outset. Butterfly-type tank capacitors with the neutralizing capacitors built into the unit (such as the B&W type) are effective in this regard.

V-h-f parasitic oscillations may take place as a result of inadequate by-passing or long by-pass leads in the filament, grid-return and plate-return circuits. Such oscillations also can take place when long leads exist between the grids and the grid tuning capacitor or between the plates and the plate tuning capacitor. The grid and plate leads should be kept short, but the leads from the tuning capacitors to the tank coils can be of any reasonable length insofar as parasitic oscillations are concerned. In an amplifier where oscillations have been traced to the grid or plate leads, their elimination can often be effected by making the grid leads much longer than the plate leads or

vice versa. Sometimes parasitic oscillations can be eliminated by using iron or nichrome wire for the grid or plate leads, or for the neutralizing leads. But in any event it will always be found best to make the neutralizing leads as short and of as heavy conductor as is practicable. Sometimes it will be of assistance to make the grid leads to the tubes of different lengths. This also is sometimes true of the plate leads.

Small v-h-f tank circuits, consisting of a few turns of heavy wire tuned by an APC capacitor, connected in series with the grid leads of an amplifier sometimes will effect a cure when all other means have failed. This expedient is somewhat of a last resort, however, since such circuits may do an adequate job when the amplifier is operated only over a comparatively narrow frequency range.

In cases where it has been found that increased length in the grid leads or the plate leads for an amplifier is required, this increased length can often be wound into the form of a small coil and still obtain the desired effect. Winding these small coils of iron or nichrome wire may sometimes be of assistance.

Where beam-tetrode tubes are used in the stage which has been found to be generating the parasitic oscillation, all the foregoing suggestions (except those specifically related to neutralizing-lead inductance) apply in general. However, there are certain additional considerations involved in elimination of parasitics from beam-tetrode amplifier stages. These considerations involve the facts that a beam-tetrode amplifier stage has greater power sensitivity than an equivalent triode amplifier, such a stage has a certain amount of screen-lead inductance which may give rise to trouble, and such stages have a small amount of feedback capacitance.

All these factors contribute to a tendency toward parasitic oscillations in such stages.

The matters of neutralization of beam-tetrode r-f amplifiers, and of reducing the effects of screen-lead inductance have been discussed in Chapter 6, *Generation of R-F Energy*.

When beam-tetrode tubes such as the 807 and 813 give trouble due to parasitics, the inclusion of a 47-ohm 2-watt carbon resistor in series with the lead between the screen by-pass capacitor and the screen terminal of the tube often will give improved operation. It is often helpful also to use a very small value of coupling capacitance between the grid of the beam tube and the tank circuit which feed excitation to it. Values of capacitance from 5 to 20 $\mu\text{fd.}$ have been used in this position in certain cases. In a particularly difficult case of parasitic oscillation it is usually helpful to connect a carbon resistor of 22 ohms or 47 ohms in series with the control-grid lead of the tube. The inclusion of this resistor will make the tube considerably more difficult to excite on the 28-Mc. and 50-Mc. bands, but it will almost invariably eliminate a v-h-f parasitic oscillation by effectively reducing the power sensitivity of the tube at these high frequencies to a very low value.

Three additional factors of considerable importance in obtaining stable operation from beam-tetrode amplifier stages are: proper amount of excitation, proper value of grid bias, and as low a screen voltage as can be used and still obtain adequate output. The combination of high screen voltage and inadequate excitation will almost invariably cause a tetrode amplifier stage to generate parasitic oscillations. Excessive excitation with normal screen voltage can also lead to the same result since the screen current will rise to excessive values when normal screen voltage is applied and too much excitation is being fed to the grid of the tube.

10-4 Coupling to the Antenna

When coupling either an antenna or an antenna feed system to a transmitter the most important considerations are as

follows: (1) means should be provided for varying the load on the amplifier; (2) the two tubes in a push-pull amplifier should be equally loaded; (3) the load presented to the final amplifier should be resistive (non-reactive) in character; and (4) means should be provided to reduce harmonic coupling between the final amplifier plate tank circuit and the antenna or antenna transmission line.

The first item is a matter of *loading*, rather than a matter of matching. The coupling between the antenna circuit and the final amplifier circuit is simply increased until the final amplifier draws the desired amount of plate current. Actually, all the matching and mismatching one need worry about pertains to the junction of the feeders and the antenna, although the antenna changeover relay sometimes will introduce standing waves.

The matter of equal load on push-pull tubes can be taken care of by simply making sure that the coupling system is symmetrical, both physically and electrically. For instance, it is not the best practice to connect a single-wire feeder directly to the tank coil of a push-pull amplifier.

The third consideration, that of obtaining a nonreactive load, is important from the standpoint of efficiency, radiated harmonics (discussed in detail in Section 10-5), and voice quality in the case of a 'phone transmitter. If the feeders are clipped directly on the amplifier plate tank coil, either the surge impedance of the feeders must match the antenna impedance perfectly (thus avoiding standing waves) or else the feeders must be cut to exact resonance.

If an inductively-coupled auxiliary tank is used as an antenna tuner for the purpose of adjusting load and tuning out any reactance, one need not worry about feeder length or complete absence of standing waves.

For this reason, it is always the safest procedure to use such an antenna coupler rather than connect directly to the plate tank coil.

Function of an Antenna Coupler The function of an output coupler is to transform the impedance of the feed line, or the antenna, into that value of plate load impedance which will allow the final amplifier to operate most effectively. The antenna coupler is, therefore, primarily an impedance transformer. It may serve a secondary purpose in filtering out harmonics of the carrier frequency. It may also tune the antenna system.

Practically every known antenna coupler can be made to give good results when properly adjusted. Certain types are more convenient to use than others, and the only general rule to follow in the choice of an antenna coupler is to use the simplest one that will serve your particular problem.

There is practically nothing that an operator can do at the station end of a transmission line that will either increase or decrease the standing waves on the line, as that is entirely a matter of the coupling between the line and the antenna itself. However, the coupling at the station end of the transmission line has a very marked effect on the efficiency and the power output of the final amplifier in the transmitter. Whenever we adjust antenna coupling and thus vary the d-c plate current on the final amplifier, all we do is vary the ratio of impedance transformation between the feed line and the tube plate (or plates).

Coupling Methods Figure 1 shows several of the most common methods of coupling between final amplifier and feed line.

The fixed capacitor C_k is a large capacitance mica capacitor in every case. It has no effect upon tuning or operation; it is merely a blocking capacitor keeping high-voltage d.c. off the transmission line.

Capacitive Coupling Figure 1A shows a simple method of coupling a single-wire non-resonant feeder to the plate tank circuit of a single-ended amplifier stage. The coupling is increased by moving the tap away from the voltage node and toward the "hot" end of the tank coil. Either the center or the bottom end of the coil may be at r-f ground potential.

The system shown in Figure 1B illustrates a means of coupling an untuned 2-wire line to a split plate tank circuit such as might be used either on a push-pull or single-ended r-f amplifier stage. If it is desired to couple a 2-wire untuned line to an unsplit plate tank, it will be necessary to use some form of inductive coupling such as is illustrated in Figure 1G.

π -Section Coupling The circuit of Figure 1C shows a π -section filter coupling an unsplit tank to any end-fed antenna or single-wire line. Figure 1D shows the 2-wire version of the π -section coupler, sometimes called the *Collins* coupler. Figure 1E shows an arrangement whereby a single-ended amplifier stage may be directly coupled to a single-wire feeder or antenna through the use of a π -section coupler without the use of an additional plate tank circuit on the amplifier stage. This system is not as good from the standpoint of harmonic reduction as the one illustrated in Figure 1C, but it will be found to be adequate for all normal purposes when large values of shunt capacitance are used in the filter section. The series inductance section should be as large as can be used and still reach resonance with a large value of capacitance across the output of the π section. The circuit of Figure 1F illustrates a method whereby a transmitter with an L-section output circuit may be used to feed a balanced tuned or untuned transmission line. The split-stator tuning capacitor and the tank coil to which the feeders are connected should tune to the operating frequency of the transmitter.

Tuning π -Section Coupler To obtain satisfactory results from the π -section coupler, certain precautions must be taken in the tuning process. The ratio of impedance transformation in π networks depends upon the ratio of the capacitances C_1 and C_2 on the input and output of the network. Also, in each case the value of the inductance L in the network must be such that it will resonate with C_1 and C_2 in series. The procedure for tuning networks of the type shown in Figures 1C and 1D is somewhat different from the tuning of networks as shown in Figures 1E and 1F.

The first step in tuning a network as shown in Figures 1C and 1D is to disconnect the π -section coupler from the plate tank entirely. Then apply low plate voltage and tune the plate tank capacitor to resonance. Remove the plate voltage and tap the π -section connection or connections approximately halfway between the cold point on the coil and the plate or plates. Adjust C_2 to approximately half maximum capacitance and apply plate voltage. Quickly adjust C_1 to the point where the d.c. plate current dips, indicating resonance.

At the minimum point in this plate current dip, the plate current will either be higher or lower than normal for the final amplifier. If it is lower, it indicates that the coupling is too loose; in other words, there is too high a ratio of impedance transformation. The plate current can be increased by *reducing* the capacitance of C_2 and then restoring resonance with capacitor C_1 . At no time after the π -section coupler is attached to the plate tank should the plate tuning capacitor be touched. If the d-c plate current with C_1 tuned to resonance is too high, it may be reduced by *increasing* the capacitance of C_2 in small steps, each time restoring resonance with capacitor C_1 .

Should the plate current persist in being too high even with C_2 at maximum capacitance, it indicates either that C_2 has too low maximum capacitance, or that the π -section filter input is

tapped too close to the plate of the final amplifier. If the plate current *cannot* be made to go high enough even with capacitor C_2 at minimum capacitance, it indicates that the input of the π section is not tapped close enough to the plate end of the plate tank coil.

Tuning of networks of the type shown in Figures 1E and 1F is accomplished in the following manner: First remove the antenna or line connection from the output of the network. Then tune C_2 to a value about $\frac{3}{4}$ of maximum capacitance, apply reduced plate voltage to the amplifier stage, and dip to resonance with C_1 . If resonance cannot be reached, change the value of inductance in L by moving the tap and again try to reach resonance with C_1 . When a value of L has been found which will allow resonance with C_2 near maximum capacitance and C_1 approximately one-third meshed, connect the feeder or feeders to the network. Apply plate voltage and dip with C_1 . If the dip is too high or if the setting of C_1 is much different from the previous setting, increase the capacitance of C_2 and again tune C_1 for resonance with plate voltage applied. If the plate current dip is too low, reduce the capacitance of C_2 and again dip with C_1 . When the proper setting of a network of this type has been obtained it will be possible to remove the line or antenna connections from the network, and then reach resonance with only a small readjustment of C_1 .

In any π network the harmonic attenuation of the section will be greatest when a sharp dip at resonance is obtained by adjustment of C_1 . This is another way of stating that harmonic attenuation will be greatest when C_2 has as large a value as can be used, and where L has as high an inductance value as can be employed while still reaching resonance and giving the proper impedance ratio. Under conditions where a sharp resonance dip *cannot* be reached with variation in the setting of C_1 , it is likely that the harmonic attenuation of the π -section coupler will be poor and spurious radiations may result.

Inductive Coupling Inductive coupling methods may be classified into two general types: direct inductive coupling and link coupling. Direct inductive coupling is the most generally used system, but link coupling offers definite advantages for certain types of applications. Figure 1G shows a direct inductive coupling system to an untuned 2-wire transmission line. This is probably the most frequently used system wherein the coupling loop is the so-called "variable link" provided at the center of most types of manufactured plug-in tank coils. Where only a fixed coupling coil is provided at the center of the tank coil, or where greater variation in coupling is desired in the case of a "variable link" coil, the arrangement shown in Figure 1H is recommended. In this system C_1 acts merely to tune out the series inductive reactance of the coupling loop at the center of the coil. By proper adjustment of the series capacitor C_1 , considerably greater coupling to the antenna or load circuit can be obtained with manufactured "variable link" coils than can be obtained without the capacitor in the circuit. This makes the circuit arrangement of Figure 1H effective in coupling into a 300-ohm or 600-ohm line with a "variable link" designed for coupling into a 75-ohm line. Many manufactured tank coils fall into this category, particularly on the 3.5-Mc. and 7-Mc. band coils.

The circuit shown in Figure 1I is the conventional method of coupling a zepp or tuned feed line to a plate tank circuit, but the arrangement shown in Figure 1M is easier to adjust. Circuit shown in Figure 1L is for coupling either a single or 2-wire untuned feeder to either a split or unsplit plate tank circuit. The arrangement shown in Figure 1N is easier to adjust. All coupling links anywhere in a transmitter should be coupled at a point of low r-f potential to avoid undesired capacitive coupling.

Untuned low-impedance lines of the twisted pair, 75-ohm

twin lead, and coaxial types can best be coupled inductively by means of a 1- or 2-turn coupling link around the plate tank coil at the voltage node.

Mechanical Considerations If inductive coupling to the final amplifier is contemplated, attention must be given to the mechanical or physical considerations. Variable coupling is a desirable feature which facilitates correct loading of the amplifier. It is more easily incorporated if but a few turns are involved. This explains the popularity of link coupling methods (such as Figure 1N) over directly coupled systems of the type illustrated in Figure 1I. Untuned lines of 600 ohms or less, when operating correctly, seldom require more than a half dozen turns in the coupling link to provide sufficient coupling, especially on the higher frequency bands. Twisted-pair lines or coaxial cable may require only 1 or 2 turns. Marconi antennas (no feed line) may require anywhere from 1 to 10 turns, depending upon the frequency and radiation resistance.

Because sometimes the next integral turn provides too much coupling while without it there is insufficient coupling, it is necessary to provide means for obtaining coupling intermediate between that provided by integral turns. This can be done by adding the next integral turn and then either pulling the coupling coil away from the tank coil a little, or enlarging the turns so that the coupling coil does not fit snugly over the tank coil.

One very satisfactory method of providing continuously variable coupling calls for a set of split tank coils, with 1- or 1½-inch spacing between the two halves of the coils (depending upon diameter of the coils). A swinging coupling link, with sufficient tension or friction on the hinge to maintain the link in position after it has been adjusted, can be inserted between the two halves of the tank coil to give any degree of coupling desired. Manufactured coils can be obtained with this system of adjustable coupling. Another type manufactured coil is wound on a ceramic coil form with an individual link turning inside the form on a shaft supported on bearings inserted in the form. The latter type requires two extra contacts on the coil jack bar.

If one uses the simpler method of pushing coupling turns down between the turns of the tank coil until sufficient coupling is obtained, high tension ignition cable is recommended if the plate voltage of more than 500 volts appears on the plate tank coil. Hookup wire or house wire is satisfactory for lower voltages.

The coupling link should never be placed at a point of high voltage on the tank coil. This means that the coupling link should be placed around the center of a split plate tank or near the "cold" end of an unsplit tank coil.

For a given number of turns in the coupling link, greatest coupling will occur when the link is placed around the center of the coil, regardless of the location of the node on the coil. For this reason, it is sometimes difficult to get sufficient coupling with an unsplit tank, as the link must be placed at the cold end of the coil in such a system to prevent detuning of the tank circuit, possible arcing between tank coil and link, and capacitive coupling of harmonics.

On the higher frequencies, it is important that superfluous reactance is not coupled into the line by a pick-up link having an excessive number of turns. This means that instead of using a 10-turn link on 28 Mc. to couple to a 72-ohm line and backing off on the coupling coil until the desired coupling is obtained, the number of turns should be reduced and the pick-up coil coupled tighter to the tank coil. For this reason, it is difficult to construct a swinging-link assembly having a single multi-turn coupling coil for coupling on all bands. With this type coupling, it usually will be found that if the pick-up coil

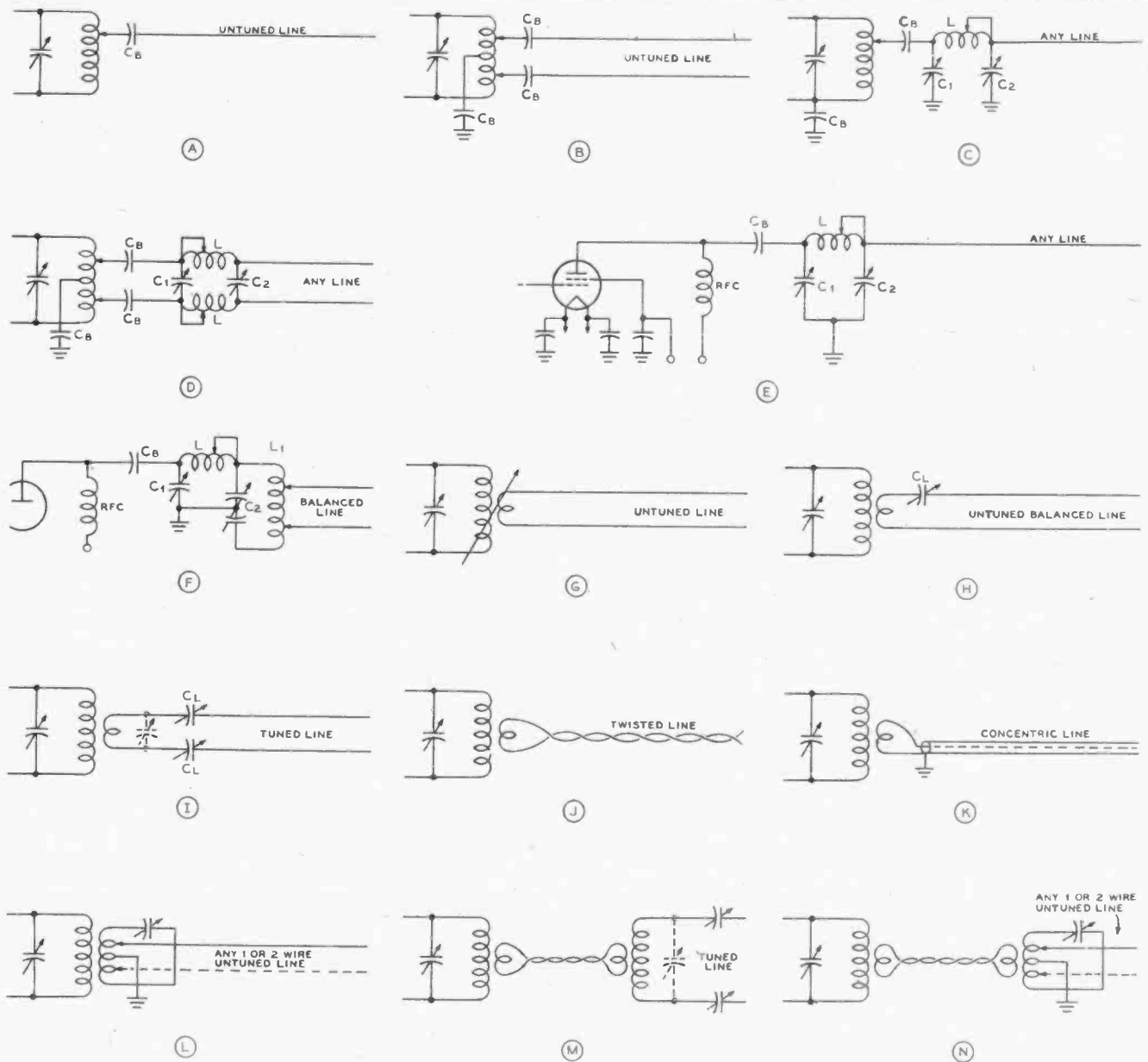

Figure 1.

COMMON METHODS OF COUPLING TRANSMISSION LINES TO THE OUTPUT TANK CIRCUIT OF THE TRANSMITTER

Balanced two-wire lines are assumed where shown, whether the lines are of the resonant (tuned) type or "flat" (untuned) type. Coupling turns should always be placed around the "cold" portion of the coil. When a coil has one end grounded to r.f. the cold portion will be near the ground end; when the center of the coil is by-passed to ground or is at ground potential the coupling turns should be placed around the center of the coil. Tuning capacitors for the tank circuit of the r-f amplifier may be split-stator (although single capacitors have been shown in all the circuits) where the center of the tank circuit is at r-f ground potential. C_B on the various drawings indicates a mica blocking capacitor to keep d.c. isolated from the feeder or transmission line; these capacitors should have a working voltage in excess of the peak plate voltage to be expected on the final amplifier stage and should be at least 0.001 μ fd. in capacitance. In regions where appreciable static voltages may be built up on the antenna or the antenna transmission line it will be wise to run an r-f choke to ground from each of the feeder legs. The various circuits and the functions of C_1 , C_2 and C_L are described in detail in the text.

has sufficient turns to permit optimum coupling on 3.5 Mc., the coil will be so large that it will couple in an objectionable amount of reactance at 28 Mc. This assumes that the transmitter works into a line of the same surge impedance on all bands.

10-5 Suppression of Harmonic Radiation

Harmonics of the oscillator frequency and harmonics of the output or carrier frequency are present in the final amplifier circuit of all transmitters. However, some transmitters and some general types of transmitters are worse in this respect than other types. It is therefore necessary that some provision

for the reduction of harmonic radiation be incorporated into the output or antenna coupling circuit of all transmitters. In simple cases this may mean only the use of a high-Q plate tank circuit and an antenna (with one side of the transmission line or the center of the coupling link grounded) which discriminates against harmonic radiation. But in the case of a high-power transmitter with a heavily-excited final amplifier it may be necessary to take especial precautions in order to effect a satisfactory reduction in harmonic radiation. The frequencies which are most likely to cause trouble in the output of a transmitter are the second and the third harmonics of the carrier frequency, although it is possible for objectionable

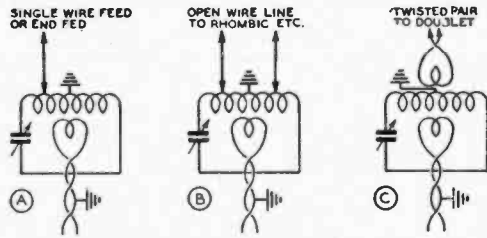

LINK COUPLING FROM SINGLE-ENDED OR P.P. R.F. AMPLIFIER

Figure 2.

SIMPLE METHODS OF HARMONIC SUPPRESSION WITH AN AUXILIARY TANK CIRCUIT.

radiation to occur on the v-h-f bands on frequencies which are equal to the carrier frequency plus and minus the crystal oscillator or v-f-o fundamental frequency.

Antennas such as the doublet fed with twisted pair, 75-ohm twinlead, or a quarter-wave transformer (such as the Johnson Q), and antennas such as the folded doublet discriminate against radiation of *even* harmonics. This factor is what keeps these types of antennas from being usable as all-band antennas. However, these types are responsive to *odd* harmonics (third and fifth principally) and operate about as well on the third as on the fundamental. For this reason any third harmonic energy present in the output of the transmitter will be radiated unless a harmonic trap or other means is used to prevent such radiation.

Most all-band antennas are responsive to both odd and even harmonics, and therefore are still worse as regards the possibility of harmonic radiation.

The delta-matched antenna, and radiators fed by means of a shorted stub and untuned line, provide about the best discrimination against harmonics, but even these will radiate some third and other odd harmonic energy.

Best practice indicates the reduction of the amount of harmonic component in the transmitter output to as low a value as possible, then further attenuation between the transmitter and antenna regardless of what antenna and feed system is used.

Three definite conditions must exist in the transmitter before harmonic radiation can take place. First, the final amplifier must either be generating or amplifying the undesired harmonics; second, the coupling system between the amplifier and the feeders or antenna system must be capable of either radiating them or transmitting them to the antenna, and third, the antenna system (or its feeders) must be capable of radiating this harmonic energy.

One effective method of reducing capacitive coupling is through the use of a Faraday shield. The Faraday shield, however, offers no attenuation to anything but *capacitive coupling* of the undesired energy. Since a great deal of the harmonic energy (the third and other odd harmonics) is *inductively* coupled to the antenna system, an arrangement which will attenuate both capacitively and inductively coupled harmonics

(both odd and even) would be desirable. A Faraday shield is not a cure-all. However, its performance is effective enough to warrant inclusion as standard equipment.

A simple and very effective method of harmonic suppression is shown in Figure 2. The link from the final-amplifier tank to the antenna tank should consist of a length of low-impedance cable such as 75-ohm or 300-ohm twinlead. This link should be loosely coupled by means of a single turn on 10 and 20 meters and two turns on 40 and 80 meters. This number of link turns should be used at either end to couple to both tank circuits. One side of the link should be effectively grounded near the final-amplifier tank.

The antenna tank itself should be of medium C (Q of about 10 or 12) at the operating frequency. In the system shown at Figure 2C the two links, the one to the final and the one to the antenna, should be spaced about 2 inches apart and at the same distance either side of the center of the antenna tank coil. The other circuits shown in Figure 2 should be self-explanatory.

This coupling system operates by virtue of the fact that capacitive coupling between the final tank and the antenna is eliminated by the grounded link and the grounded center tap of the antenna tank; also, due to the selectivity of the antenna tank against the harmonic frequencies, inductive coupling of them into the antenna system will also be attenuated.

Run a test with some local station close enough to give you an accurate check, and see if your harmonics are objectionable.

A Simple

Universal Coupler

A split-stator capacitor of 200 μ fd. or more per section can be mounted on a small board along with a large and a small multitapped coil to make a very useful and versatile antenna coupler and harmonic suppressor. With this unit it is possible to resonate and load almost any conceivable form of radiator and tuned feed system, and to adjust the loading and provide harmonic suppression with almost any untuned transmission line. The circuit is shown in Figure 3.

Because under certain conditions and in certain uses both rotor and stator will be hot with r-f voltage, an insulated extension is provided for the capacitor shaft in order to remove the dial from the capacitor by a few inches. This effectively reduces body capacitance. It also precludes the possibility of being burned by the dial set-screw.

The large coil consists of 30 turns of no. 12 wire, 4 inches in diameter and spaced to occupy 5 3/4 inches of winding space. The small coil consists of 14 turns, 2 inches in diameter, spaced to occupy 3 1/4 inches of winding space. Heavy duty 80- and 20-meter coils of commercial manufacture will serve nicely.

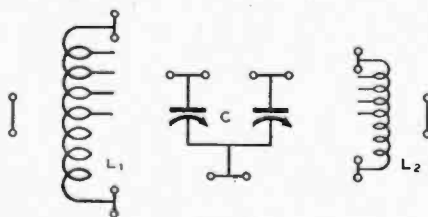

Figure 3.

CIRCUIT DIAGRAM OF THE UNIVERSAL COUPLER.

The dots indicate heavy Fahnestock clips. For coil and capacitor constants, see text.

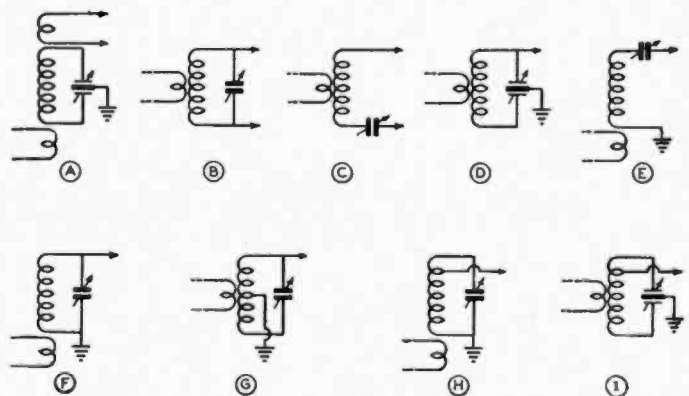

Figure 4.

APPLICATIONS OF THE UNIVERSAL ANTENNA COUPLER.

Radiation and Propagation

RADIO waves are electromagnetic waves similar in nature but much lower in frequency than light waves or heat waves. Such waves represent electric energy traveling through space. Radio waves travel in free space with the velocity of light and can be reflected and refracted much the same as light waves.

11-1 Radiation from an Antenna

Alternating current passing through a conductor creates an alternating electromagnetic field around that conductor. Energy is alternately stored in the field, and then returned to the conductor. As the frequency is raised, more and more of the energy does not return to the conductor, but instead is radiated off into space in the form of electromagnetic waves, called radio waves. Radiation from a wire, or wires, is materially increased whenever there is a sudden *change* in the *electrical constants* of the line. These sudden changes produce reflection, which places *standing waves* on the line.

When a wire in space is fed radio frequency energy having a wavelength of approximately 2.08 times the length of the wire in meters, the wire *resonates* as a *dipole* or half-wave antenna at that wavelength or frequency. The greatest possible change in the electrical constants of a line is that which occurs at the open end of a wire. Therefore, a dipole has a great mismatch at each end, producing a high degree of reflection. We say that the dipole is terminated in an infinite impedance (open circuit). An incident radio frequency wave traveling to one end of the dipole is reflected right back towards the center of the dipole after reaching the end, as there is no place else for it to go.

A returning wave which has been reflected meets the next incident wave, and the voltage and current at any point along the antenna are the algebraic sum of the two waves. At the ends of the dipole, the voltages add up, while the currents of the two waves cancel, thus producing *high voltage* and *low current* at the ends of the dipole or half-wave section of wire. In the same manner, it is found that the currents add up while the voltages cancel at the center of the dipole. Thus, at the center there is *high current* but *low voltage*.

Inspection of Figure 1 will show that the current in a dipole decreases sinusoidally towards either end, while the voltage similarly increases. The voltages at the two ends of the an-

tenna are 180° out of phase, which means that the polarities are opposite, one being plus while the other is minus at any instant. A curve representing either the voltage or current on a dipole represents a *standing wave* on the wire.

Radiation from Sources other than Antennas Radiation can and does take place from sources other than antennas.

Undesired radiation can take place from open-wire transmission lines, both from single-wire lines and from lines comprised of more than one wire. In addition, radiation can be made to take place in a very efficient manner from electromagnetic horns, from plastic lenses or from electromagnetic lenses made up of spaced conducting planes, from slots cut in a piece of metal, from dielectric wires, or from the open end of a wave guide. But for the most part the radiating systems used by amateurs are made up of wires or metallic rods operated by themselves or in conjunction with non-resonant reflecting surfaces. The construction of antennas for operation on amateur frequencies is discussed in detail in Part III of this *Handbook*, Chapters 27, 28, 29, and 30.

Directivity of Radiation The radiation from any physically practicable radiating system is directive to a certain degree. The degree of directivity can be enhanced or altered when desirable through the combination of radiating elements in a prescribed manner, through the use of reflecting planes or curved surfaces, or through the use of such systems as mentioned in the preceding paragraph. The construction of directive antenna arrays is covered in detail in Chapters 28, 29, and 30.

Polarization Like light waves, radio waves can have a definite polarization. In fact, while light waves ordinarily have to be reflected or passed through a polarizing medium before they have a definite polarization, a radio wave leaving a simple radiator will have a definite polarization, the polarization being indicated by the orientation of the electrostatic component of the wave. This, in turn, is determined by the orientation of the radiator itself, as the electromagnetic component is always at right angles to a linear radiator, and the electrostatic component is always in the same plane as the

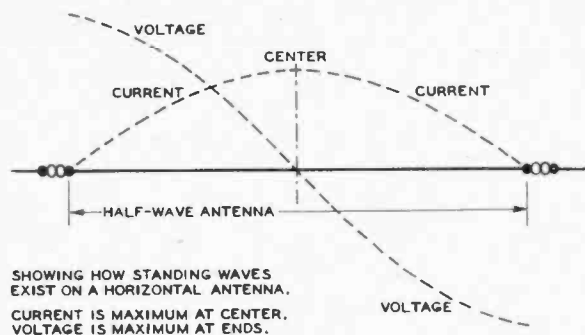

SHOWING HOW STANDING WAVES EXIST ON A HORIZONTAL ANTENNA. CURRENT IS MAXIMUM AT CENTER. VOLTAGE IS MAXIMUM AT ENDS.

Figure 1. STANDING WAVES ON AN ANTENNA.

radiator. Thus we see that an antenna that is vertical with respect to the earth will transmit a vertically polarized wave, as the electrostatic lines of force will be vertical. Likewise, a simple horizontal antenna will radiate horizontally polarized waves.

Because the orientation of a simple linear radiator is the same as the polarization of the waves emitted by it, the radiator itself is referred to as being either vertically or horizontally polarized. Thus, we say that a horizontal antenna is horizontally polarized.

Figure 2A illustrates the fact that the polarization of the electric field of the radiation from a vertical dipole is vertical. Figure 2B, on the other hand, shows that the polarization of electric-field radiation from a vertical slot radiator is horizontal. This fact has been utilized in certain commercial FM antennas where it is desired to have horizontally polarized radiation but where it is more convenient to use an array of vertically stacked slot arrays. If the metallic sheet is bent into a cylinder with the slot on one side, substantially omnidirectional horizontal coverage is obtained with horizontally-polarized radiation when the cylinder with the slot in one side is oriented vertically. An arrangement of this type is shown in Figure 2C. Several such cylinders may be stacked vertically to reduce high-angle radiation and to concentrate the radiated energy at the useful low radiation angles.

In any event the polarization of radiation from a radiating system is parallel to the electric field as it is set up inside or in the vicinity of the radiating system.

11-2 Propagation of Radio Waves

The preceding section has discussed briefly the manner in which an electromagnetic-wave or radio-wave field may be set up by a radiating system. However, for this field to be useful for communication or for measurement, the field must be propagated to some distant point where the signal may be received, or where the wave may be reflected again to be received at another point.

Propagation of a radio wave between two points may take place in a number of different ways. In fact there are five different general modes known at this time in which waves of different frequency may be propagated. These five modes of propagation are: (1) Direct Communication, (2) Ground-Wave Communication, (3) Atmospheric Bending, (4) Stratospheric Reflection, and (5) Ionospheric Propagation. Each of these modes of propagation and several of the subdivisions of certain of the modes will be discussed in turn.

Direct Communication Horizon, local, or direct point-to-point propagation all refer to communication between two points lying in a path where there is no obstruction to the waves. The distance involved might be one mile or two-hundred miles, depending upon the eleva-

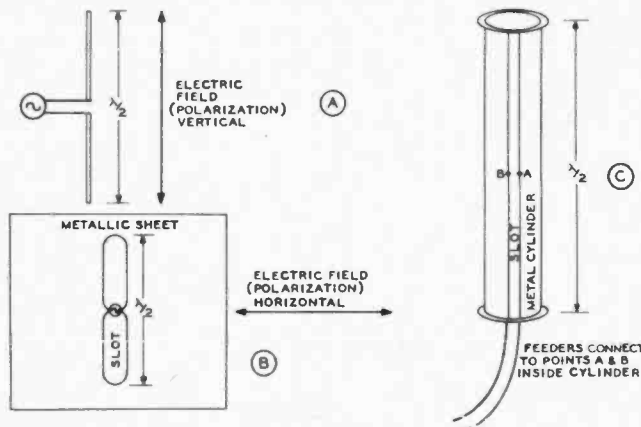

Figure 2. ANTENNA FIELD POLARIZATION.

The radiated field from a dipole such as is shown in (A) above is parallel to the extent of the radiator. In the case of a resonant slot cut in a sheet of metal and used as a radiator the polarization (of the electric field) is perpendicular to the extent of the slot. In both cases, however, the polarization of radiation is parallel to the potential gradient on the radiator; in the case of the dipole the gradient is from end-to-end and in the case of the slot the field is across the sides of the slot. The metallic sheet containing the slot radiator may be bent into a cylinder to make up the radiator shown in (C). With this radiator mounted vertically, its polarization of radiation is horizontal.

tion of the antennas and the character of the intervening terrain.

The distance from an elevated point to the horizon is given by the approximate equation: $d = 1.22\sqrt{H}$ where the distance d is in miles and the antenna height H is in feet. This equation must be applied separately to the transmitting and receiving antennas and the results added. However, refraction and diffraction of the signal around the spherical earth cause a smaller reduction in field strength than would occur in the absence of such bending, so that the average radio horizon is somewhat beyond the optical horizon.

There is, however, no sharp discontinuity of the signal at the horizon; that is, an airplane taking off beyond and below the horizon will begin to encounter some signal before reaching an altitude from which the transmitting antenna is actually in sight.

Ground-Wave Communication Ground-wave communication (as contrasted to surface-wave propagation which is primarily of importance in the broadcast band and on frequencies below 500 kc.) is primarily of importance in the propagation of frequencies above perhaps 40 Mc. This term is most commonly applied to communication on the 50-Mc. band and higher for communication out to 30 or 40 miles and at much greater distances when the antennas are considerably elevated. The waves are propagated, presumably, by diffraction or dispersion around the curve in the earth's surface in the same way as light is diffracted around a sharp corner. When using this type of propagation the transmitting and receiving antennas give best results when both are either horizontally or vertically polarized.

Pre-skip, extended ground wave, and refracted-diffracted propagation mean essentially the same thing. All refer to distances out to perhaps 200 or 300 miles, in the absence of unusual aurora or magnetic activity. Beams are pointed close to the direct line between the stations. The first two terms refer to the distance but not to the method by which the transmission is accomplished, and presumably differ from the local or ground wave type only because the greater distance is covered as a result of more power, better antennas, or more sensitive receivers.

Atmospheric-Bending Propagation

Atmospheric-bending propagation, or low-atmosphere bending, refer to propagation over a considerable distance with the aid of a temperature discontinuity or inversion in the lower atmosphere that bends the waves slightly downward, thus extending the range of communication. Propagation conditions of this type have been known to give ranges of greater than 1500 miles on frequencies in the vicinity of 175 Mc. When bending conditions are particularly favorable they may give rise to the formation of a *duct* which can propagate waves with very little attenuation over great distances in a manner similar to the propagation of waves through a wave guide.

Guided propagation through a duct in the atmosphere can give quite remarkable transmission conditions, but little is generally known about this type of propagation other than the fact that a duct when formed in this manner lies very close to the surface of the ocean (usually below 40 feet) and that such a duct exhibits a low-frequency cut-off characteristic similar to a wave guide. The *lowest* frequency that can be propagated by such a duct usually lies above 50 Mc.

Conditions Leading to Temperature Inversions

When the temperature, pressure, or water-vapor content of the atmosphere does not change smoothly with rising altitude, the discontinuity causes a slight bend in the waves and thus, if the bend is downward, extends the range. Ordinarily this condition is more prevalent at night and in the summer. In certain areas, such as along the west coast of North America, it is believed to be frequent enough to be considered normal. Signal strength decreases with distance and, if the favorable condition in the lower atmosphere covers sufficient area, the range is limited only by the transmitter power, antenna gain, receiver sensitivity, and signal-to-noise ratio. There is no skip distance. Usually, transmission due to this condition is accompanied by slow fading, although fading can be violent at a point where direct waves of about the same strength are also received.

Bending in the troposphere, which refers to the region from the earth's surface up to about 10 kilometers, is more likely to occur on days when there are stratus clouds than on clear, cool days with a deep blue sky. The temperature or humidity discontinuities may be broken up by vertical convection currents over land in the daytime but are more likely to continue during the day over water. This condition is in some degree predictable from weather information several days in advance. It does not depend on the sunspot cycle. Like direct communication, best results require similar antenna polarization or orientation at both the transmitting and receiving ends, whereas in transmission via a reflection in the ionosphere (that part of the atmosphere between about 50 and 500 kilometers high) it makes little difference whether antennas are similarly oriented.

Figure 3 illustrates an air mass boundary at 3.4 kilometers, taken from United States Weather Bureau free air data in the vicinity of New York City, at a time when the same height was indicated by ultra-high frequency measurements being made by Bell Laboratories. The arrow points to the inversion or discontinuity in temperature and vapor pressure, and the resulting change in the dielectric constant of the air.

Figure 4 shows typical v-h-f propagation characteristics for a sea-water path in the vicinity of New York City, calculated for an air mass boundary at 1500 meters (curve A) and for the earth refracted-diffracted radiation component for ground conductivity 5×10^{-11} E. M. U., and dielectric constant 80 for sea water (curve B) for horizontal and vertical antennas, wave length 4.7 meters (64 megacycles), short doublet antennas, 1 kilowatt power radiated. Most severe fading is generally en-

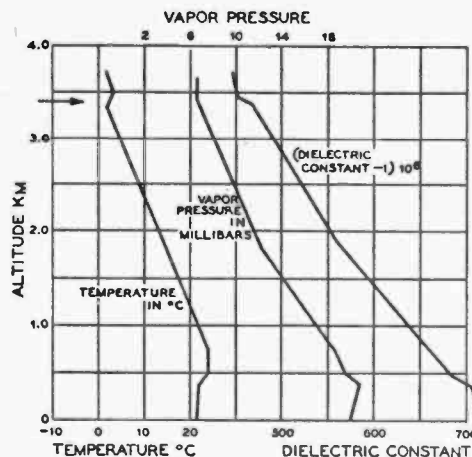

Figure 3.
ILLUSTRATING TYPICAL TEMPERATURE INVERSION AT 3.4 KM.

Air mass boundary heights shown by U.S. Weather Bureau free air data, compared to measured heights from frequency sweep patterns on ultra high frequencies.

countered at such a distance that curves A and B cross, with slow fading at greater distances.

Stratospheric Reflection

Communication by virtue of stratospheric reflection can be brought about during magnetic storms, aurora borealis displays, and during meteor showers. Dx communication during extensive meteor showers is characterized by frequent bursts of great signal strength followed by a rapid decline in strength of the receiver signal. The motion of the meteor forms an ionized trail of considerable extent which can bring about effective reflection of signals. However, the ionized region persists only for a matter of seconds so that a shower of meteors is necessary before communication becomes possible.

The type of communication which is possible during visible displays of the aurora borealis and during magnetic storms has been called *aurora-type dx*. These conditions reach a maximum somewhat after the sunspot cycle peak, possibly because the spots on the sun are nearer to its equator (and more directly in line with the earth) in the latter part of the cycle. Ionospheric storms generally accompany magnetic storms. The normal layers of the ionosphere may be churned or broken up, making radio transmission over long distances difficult or impossible on high frequencies. Unusual conditions in the ionosphere sometimes modulate v-h-f waves so that a definite tone or noise modulation is noticed even on transmitters located only a few miles away.

Information is not available as to how high a frequency will be returned by the ionized stratosphere under these conditions, but it is known that frequencies from 25 to 60 Mc. are affected. A peculiarity of this type of propagation of v-h-f signals in the northern hemisphere is that directional antennas usually must be pointed in a northerly direction for best results for transmission or reception, regardless of the direction of the other station being contacted. Distances out to 700 or 800 miles have been covered during magnetic storms, using 30 and 60 Mc. transmitters, with little evidence of any silent zone between the stations communicating with each other. Generally, voice-modulated transmissions are difficult or impossible due to the tone or noise modulation on the signal. Most of the communication of this type has taken place by c.w. or by tone modulated waves with a keyed carrier, and using receivers having an *i.f.* selectivity comparable to that of ordinary commercial high frequency receivers. Because of the association of this type of transmission with magnetic storms, it is assumed

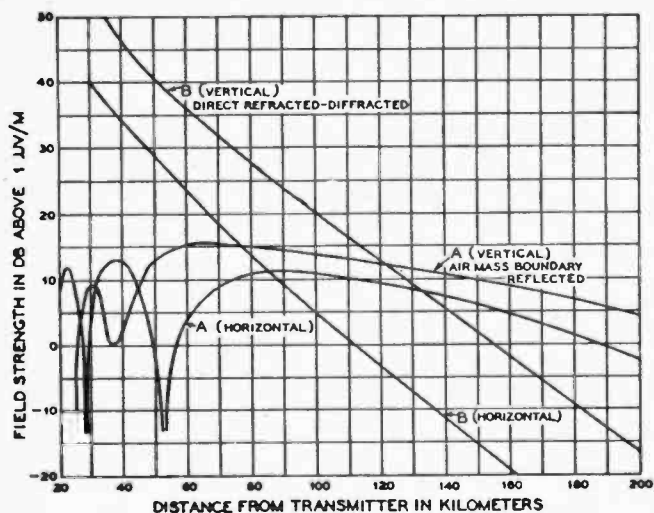

Figure 4.

TYPICAL U.H.F. PROPAGATION CHARACTERISTICS.

Calculated curves for air boundary reflected and earth refracted-diffracted radiation components, in both vertical and horizontal polarization. Short doublet antennas, 1 kw. power radiated, wavelength 4.7 meters, ground conductivity 5×10^{-11} E.M.U., and dielectric constant 80 for sea water. Height of transmitting antenna 42 meters, of receiving antenna 5 meters, air boundary height 1500 meters, effective radius of earth 8500 kilometers.

that the necessary condition is more likely to occur during or following the sunspot cycle peak.

11-3 Ionospheric Propagation

Propagation of radio waves for communication on frequencies between perhaps 3 and 30 Mc. is normally carried out by virtue of *ionospheric reflection* or *refraction*. Under conditions of abnormally high ionization in the ionosphere, communication has been known to have taken place by ionospheric reflection on frequencies as high as 50 Mc.

The ionosphere consists of layers of ionized particles of gas located above the stratosphere, and extending up to possibly 300 miles above the earth. Thus we see that high-frequency radio waves may travel over short distances in a direct line from the transmitter to the receiver, or they can be radiated upward into the ionosphere to be bent downward in an indirect ray, returning to earth at considerable distance from the transmitter. The wave reaching a receiver via the ionosphere route is termed a *sky wave*. The wave reaching a receiver by traveling in a direct line from the transmitting antenna to the receiving antenna is commonly called a *ground wave* and has been discussed in Section 11-2.

The amount of bending which the sky wave undergoes depends upon its frequency, and the amount of *ionization* in the ionosphere, which is in turn dependent upon radiation from the sun. The sun increases the density of the ionosphere layers, and lowers their effective height. For this reason, radio waves act very differently at different times of day, and at different times of the year.

The higher the frequency of a radio wave, the farther it penetrates the ionosphere, and the less it tends to be bent back toward the earth. The lower the frequency, the more easily the waves are bent, and the less they penetrate the ionosphere. 160-meter and 80-meter signals will usually be bent back to earth even when sent almost straight up, and may be considered as being *reflected* rather than *refracted*. As the frequency is raised beyond about 5,000 kc. (dependent upon the critical frequency of the ionosphere at the moment), it is found that waves transmitted at angles higher than a certain critical angle *never return to earth*. Thus, on the higher frequencies, it is

usually desirable to confine radiation to low angles, since the high angle waves simply penetrate the ionosphere and keep right on going and never return.

The F Layer The higher of the two major reflecting regions of the ionosphere is called the *F* layer. This layer has a virtual height of approximately 200 miles at night, and in the daytime it splits up into two layers, the upper one being called the *F₂* layer and the lower being called the *F₁* layer. The height of the *F₂* layer is normally about 275 miles on the average and the *F₁* layer often has a height of as low as 140 miles. It is the *F* layer which supports all nighttime amateur dx communication and nearly all daytime dx propagation.

Critical Frequency The critical frequency of an ionospheric layer is the highest frequency which will be reflected when the wave strikes the layer at vertical incidence. The critical frequency of the most highly ionized layer of the ionosphere may be as low as 2 Mc. at night and as high as 8 or 10 Mc. in the middle of the day. The critical frequency is directly of interest to amateurs in that a "skip-distance" zone will exist on all frequencies *greater* than the highest critical frequency at that time. The critical frequency is a measure of the density of ionization of the reflecting layers. The higher the critical frequency the greater the density of ionization.

Maximum Usable Frequency The *maximum usable frequency* or *m.u.f.* is of considerably greater interest to amateur operators since this frequency is the highest that can be used for communication between any two specified areas. The *m.u.f.* is the highest frequency at which a wave projected into space in a certain direction will be returned to earth in a specified region by ionospheric reflection. The *m.u.f.* is highest at noon or in the early afternoon and is highest in periods of greatest sunspot activity. The *m.u.f.* has been known to be as high as 50 Mc. between certain regions in the U.S. and Europe in the Winter of 1946, and is reported to have reached even higher frequencies in the Central Pacific Area. The *m.u.f.* often drops to frequencies below 10 Mc. in the early morning hours. The high *m.u.f.* in the middle of the day is brought about by reflection from the *F₂* layer. *M.u.f.* data is published periodically in the magazines devoted to amateur work, and the *m.u.f.* can be calculated with the aid of *Basic Radio Propagation Predictions*, CRPL-D, published monthly by the Government Printing Office, Washington, D.C. Single copies of this publication are 15 cents, the subscription price is \$1.50 per year.

Absorption and Optimum Working Frequency The optimum working frequency for any particular direction and distance is always just slightly less than the *m.u.f.* for contact with that particular location. The absorption by the ionosphere becomes greater and greater as the operating frequency is progressively lowered below the *m.u.f.* It is this condition which causes signals to increase tremendously in strength on the 14-Mc. and 28-Mc. bands just before the signals drop completely out. At the time when the signals are greatest in amplitude the operating frequency is equal to the *m.u.f.* Then as the signals drop out the *m.u.f.* has become lower than the operating frequency.

Skip Distance The shortest distance from a transmitting location at which signals reflected from the ionosphere can be returned to the earth is called the *skip distance*. As was mentioned above under *Critical Frequency* there is no skip distance for a frequency below the critical frequency of the most highly ionized layer of the ionosphere at the time of transmission. However, the skip distance is always present

on the 14-Mc. band and is almost always present on the 3.5-Mc. and 7-Mc. bands at night. The actual measure of the skip distance is the distance between the point where the ground wave falls to zero and the point where the sky wave begins to return to earth. This distance may vary from 40 to 50 miles on the 3.5-Mc. band to thousands of miles on the 28-Mc. band.

The E Layer,

Sporadic-E Propagation

The lower of the two important ionosphere layers is the E layer. It is this layer which accounted for dx on the old 160-meter band and which does account for dx on the broadcast band at night. The E layer itself is not of particular interest to amateur communication, but often a *sporadic* condition exists in this layer, the height of which is usually about 110 kilometers (68 miles) above sea level, which will reflect the highest frequency waves that return to the earth. A single hop can be as long as 1,200 miles, or moderately longer at favorable locations or with antennas producing effective low angle radiation (below 3°). Occasionally 1,300 or 1,400 miles can be covered in a single hop, possibly with the help of low atmosphere bending at each end. Sporadic-E layer reception may occur at any time, but is much more prevalent from late April to early September in the northern temperate zone, and slightly more likely to occur in the late morning and early evening. The sporadic -E layer is spotty, accounting for reception in definite areas completely surrounded by a silent zone, and permitting only a few days of double hop reception during a period of several years. Sporadic-E reflections support communication at frequencies up to at least 60 Mc., reception at as short a distance as 310 statute miles on 56 Mc., in one instance, indicates that the ionization was sufficiently intense so that, theoretically, frequencies as high as 2½ meters (112 Mc.) might have been received erratically at 1,200 miles on that day. At increasing frequencies the silent zone is larger and the reception zone smaller, indicating that the practical limit of sporadic reflections by this layer may be in the vicinity of 80 to 100 Mc.

It is this sporadic-E condition which provides "short-skip" contacts from 400 to perhaps 1200 miles on the 28-Mc. band in the evening. It is also the sporadic-E condition which provides the more common type of "band opening" experienced on the 50-Mc. band when very loud signals are received from stations approximately 1200 miles distant.

Cycles in

Ionosphere Activity

The ionization density of the ionosphere is determined by the amount of radiation (probably ultra violet) which is being received from the sun. Consequently, ionosphere activity is a function of the amount of radiation of the proper character being emitted by the sun and is also a function of the relative aspect of the regions in the vicinity of the location under discussion to the sun. There are four main cycles in ionosphere activity. These cycles are: the daily cycle which is brought about by the rotation of the earth, the 27-day cycle which is caused by the rotation of the sun, the seasonal cycle which is caused by the movement of the earth in its orbit, and the 11-year cycle which is a cycle in sunspot activity. The effects of these cycles are superimposed insofar as ionosphere activity is concerned. Also, the cycles are subject to short term variations as a result of magnetic storms and similar terrestrial disturbances.

Angle of Radiation

For a certain frequency, ionosphere height, and transmitting distance there is an optimum angle with respect to the horizon at which the signal should be transmitted. For extremely long distance transmission the angle should be low (8 to 15 degrees above the horizon) so that the wave may arrive with the fewest possible

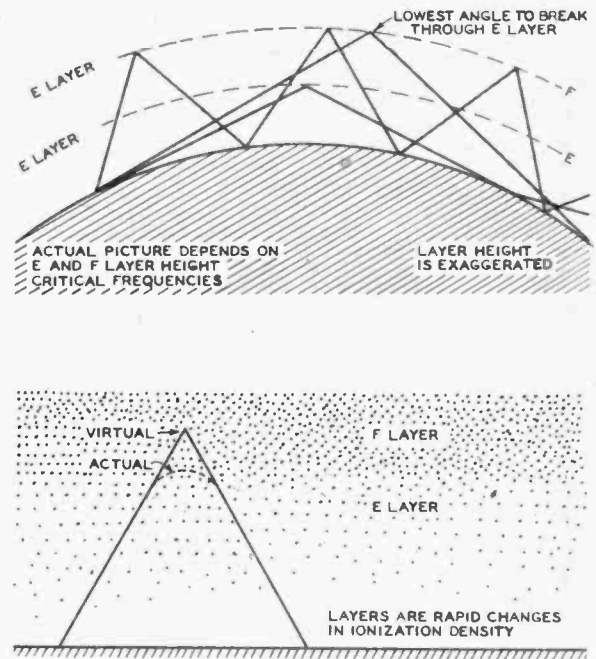

Figure 5.

Illustrating how the ionized atmosphere or ionosphere layer can bend radio waves back to earth, and some of the many possible paths of a high-frequency sky wave signal.

reflections. For normal communication in the manner in which the bands are most commonly used the following angles of radiation are recommended:

- 3.5-Mc. Band—Very high angle radiation is best for local net operating and traffic handling where consistency is important.
- 7.0-Mc. Band—Angles from 25° to 40°, the lower angles being best for dx.
- 14-Mc. Band—Angles from 10° to 25°, depending upon distance.
- 28-Mc. Band—Angle below 10° for both dx and local work.
- 50-Mc. Band and Higher Frequencies—Lowest possible angle of radiation.

Fading

The lower the angle of radiation of the wave, with respect to the horizon, the farther away will the wave return to earth, and the greater the skip distance. The wave can be reflected back up into the ionosphere by the earth, and then be reflected back down again, causing a second skip distance area. The drawing of Figure 5 shows the multiple reflections possible. When the receiver receives signals which have traveled over more than one path between transmitter and receiver, the signal impulses will not all arrive at the same instant, as they do not all travel the same distance. When two or more signals arrive in the same phase at the receiving antenna, the resulting signal in the receiver will be quite loud. On the other hand, if the signals arrive 180° out of phase, so they tend to neutralize each other, the received signal will drop,—perhaps to zero, if perfect neutralization occurs. This explains why high-frequency signals fade in and out.

Fading can be greatly reduced on the high frequencies by using a transmitting antenna with sharp vertical directivity, thus cutting down the number of multiple paths of signal arrival. A receiving antenna with similar characteristics (sharp vertical directivity) will further reduce fading. It is desirable, when using antennas with sharp vertical directivity, to use the lowest vertical angle consistent with good signal strength for the frequency used.

Principles of Antennas and Transmission Lines

IN CHAPTER 11 there was given a brief introduction into the method by which radiation takes place. Amateur practice as of this date has involved almost exclusively the use of radiating systems composed of elements made up of wire or relatively short pieces of metallic tubing. Transmission lines are almost exclusively of the parallel-wire or coaxial-conductor type. Therefore this chapter will be devoted to the general principles underlying the operation of such systems.

12-1 General Characteristics of Antennas

All antennas have certain general characteristics to be enumerated. It is the result of differences in these general characteristics which makes one type of antenna system most suitable for one type of application and another type best for a different application. Six of the more important characteristics are: (1) polarization, (2) radiation resistance, (3) horizontal directivity, (4) vertical directivity, (5) bandwidth, and (6) effective power gain.

The *polarization* of an antenna or radiating system is the direction of the electric field vector and has been defined in Section 11-1.

The *radiation resistance* of an antenna system is normally referred to the feed point in an antenna fed at a current loop, or it is referred to a current loop in an antenna system fed at another point. The radiation resistance is that value of resistance which, if inserted in series with the antenna at a current loop would dissipate the same energy as is actually radiated by the antenna if the antenna current at the feed point were to remain the same.

The *horizontal* and *vertical directivity* can best be expressed as a *directive pattern* which is a graph showing the relative radiated field intensity against *azimuth* angle for horizontal directivity and field intensity against *elevation* angle for vertical directivity.

The *bandwidth* of an antenna is a measure of its ability to operate within specified limits over a range of frequencies.

Bandwidth can be expressed either "operating frequency plus-or-minus a specified per cent of operating frequency" or "operating frequency plus-or-minus a specified number of megacycles" for a certain standing-wave-ratio limit on the transmission line feeding the antenna system.

The *effective power gain* or *directive gain* of an antenna is the ratio between the power required in the specified antenna and the power required in a reference antenna (usually a half-wave dipole) to attain the same field strength in the favored direction of the antenna under measurement. Directive gain may be expressed either as an actual power ratio, or as is more common, the power ratio may be expressed in decibels.

12-2 Frequency and Antenna Length

All antennas commonly used by amateurs, excepting the terminated rhombic, are based on the fundamental Hertz type, which is a wire in space a half wavelength long electrically. A linear, resonant dipole, which is a half wavelength long *electrically*, is actually slightly less than a half wave long *physically*, due to the capacitance to ground, "end effects," and the fact that the velocity of a high-frequency radio wave traveling along the conductor is not quite as high as it is in free space.

Physical Length of a Half-Wave Antenna If the cross section of the conductor which makes up the antenna is kept very small with respect to the antenna length, the effects mentioned in the previous paragraph are relatively constant so that an electrical half wave is a fixed percentage shorter than a physical half-wavelength. This percentage is approximately 5 per cent. Therefore, most linear half-wave antennas are close to 95 per cent of a half wave long physically. Thus, a half-wave antenna resonant at exactly 80 meters would be one-half of 0.95 times 80 meters in length. Another way of saying the same thing is that a wire resonates at a wavelength of about 2.1 times its length in meters. If the

diameter of the conductor begins to be an appreciable fraction of a wavelength, as when tubing is used as a v-h-f radiator, the factor becomes slightly less than 0.95. For the use of wire and not tubing on frequencies below 30 Mc., however, the figure of 0.95 may be taken as accurate. This assumes a radiator removed from surrounding objects, and with *no bends*.

Simple conversion into feet can be obtained by using the factor 1.56. To find the physical length of a half-wave 80-meter antenna, we multiply 80 times 1.56, and get 124.8 feet for the length of the radiator.

It is more common to use frequency than wavelength when indicating a specific spot in the radio spectrum. For this reason, the relationship between wavelength and frequency must be kept in mind. As the velocity of radio waves through space is constant at the speed of light, it will be seen that the more waves that pass a point per second (higher frequency), the closer together the peaks of those waves must be (shorter wavelength). Therefore, the higher the frequency the lower the wavelength.

A radio wave in space can be compared to a wave in water. The wave, in either case, has peaks and troughs. One peak and one trough constitute a *full wave*, or *one wavelength*.

Frequency describes the number of wave cycles or peaks passing a point per second. Wavelength describes the distance the wave travels through space during one cycle or oscillation of the antenna current; it is the distance in meters between adjacent peaks or adjacent troughs of a wave train.

As a radio wave travels 300,000,000 meters a second (speed of light), a frequency of 1 cycle per second corresponds to a wavelength of 300,000,000 meters. So, if the frequency is multiplied by a million, the wavelength must be divided by a million, in order to maintain their correct ratio.

A frequency of 1,000,000 cycles per second (1,000 kc.) equals a wavelength of 300 meters. Multiplying frequency by 10 and dividing wavelength by 10, we find: a frequency of 10,000 kc. equals a wavelength of 30 meters. Multiplying and dividing by 10 again, we get: a frequency of 100,000 kc. equals 3 meters wavelength. Therefore, to change wavelength to frequency (in kilocycles), simply divide 300,000 by the wavelength in meters (λ).

$$F_{kc} = \frac{300,000}{\lambda}$$

$$\lambda = \frac{300,000}{F_{kc}}$$

Now that we have a simple conversion formula for converting wavelength to frequency and vice versa, we can combine it with our wavelength versus antenna length formula, and we have the following:

Length of a half-wave radiator made from wire (no. 14 to no. 10):

$$\begin{aligned} & \text{3.5-Mc. to 30-Mc. bands} \\ \text{Length in feet} &= \frac{468}{\text{Freq. in Mc.}} \\ & \text{50-Mc. band} \\ \text{Length in feet} &= \frac{460}{\text{Freq. in Mc.}} \\ & \text{144-Mc. band} \\ \text{Length in inches} &= \frac{5600}{\text{Freq. in Mc.}} \\ & \text{144-Mc. band} \\ \text{Length in inches} &= \frac{5500}{\text{Freq. in Mc.}} \end{aligned}$$

When a half-wave radiator is constructed from tubing or rod whose diameter is an appreciable fraction of the length of the radiator, the resonant length of a half-wave antenna

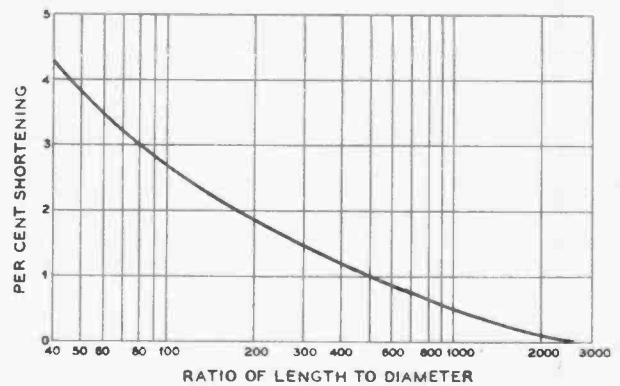

Figure 1.
CHART SHOWING SHORTENING OF A RESONANT ELEMENT IN TERMS OF RATIO OF LENGTH TO DIAMETER.

The use of this chart is based on the basic formula where radiator length in feet is equal to 468/frequency in Mc. This formula applies on frequencies below perhaps 30 Mc. when the radiator is made from wire. On higher frequencies, or on 14 and 28 Mc. when the radiator is made of large-diameter tubing, the radiator is shortened from the value obtained with the above formula by an amount determined by the ratio of length to diameter of the radiator. The amount of this shortening is obtainable from the chart shown above.

will be shortened. The amount of shortening can be determined with the aid of the chart of Figure 1. In this chart the amount of additional shortening over the values given in the previous paragraph is plotted against the ratio of the length to the diameter of the half-wave radiator.

The length of a wave in free space is somewhat longer than the length of an antenna for the same frequency. The actual free-space wavelength is given by the following expressions:

$$\text{Wavelength} = \frac{492}{\text{Freq. in Mc.}} \text{ in feet}$$

$$\text{Wavelength} = \frac{5905}{\text{Freq. in Mc.}} \text{ in inches}$$

Harmonic Resonance A wire in space resonates at more than one frequency. The *lowest* frequency at which it resonates is called its *fundamental* frequency, and at that frequency it is approximately a half wavelength long. A wire can have two, three, four, five, or more standing waves on it, and thus it resonates at approximately the integral harmonics of its fundamental frequency. However, the higher harmonics are not exactly integral multiples of the lowest resonant frequency.

A harmonic operated antenna is somewhat longer than the corresponding integral number of dipoles, and for this reason, the dipole length formula cannot be used simply by multiplying by the corresponding harmonic. The intermediate half wave sections do not have "end effects." Also, the current distribution is disturbed by the fact that power can reach some of the half wave sections only by flowing through other sections, the latter then acting not only as radiators, but also as transmission lines. For the latter reason, the resonant length will be dependent to an extent upon the method of feed, as there will be less attenuation of the current along the antenna if it is fed at or near the center than if fed towards or at one end. Thus, the antenna would have to be somewhat longer if fed near one end than if fed near the center. The difference would be small, however, unless the antenna were at least 4 wavelengths long.

Under conditions of severe current attenuation, it is possible for some of the nodes, or loops, actually to be slightly greater than a physical half wavelength apart. It is obvious that with

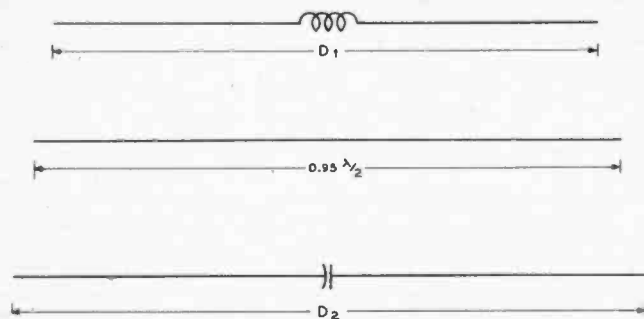

Figure 2.

EFFECT OF SERIES INDUCTANCE AND CAPACITANCE ON THE LENGTH OF A HALF-WAVE RADIATOR.

The top antenna has been electrically lengthened by placing a coil in series with the center. In other words, an antenna with a lumped inductance in its center can be made shorter for a given frequency than a plain wire radiator. The bottom antenna has been capacitively shortened electrically. In other words, an antenna with a capacitor in series with it must be made longer for a given frequency since its effective electrical length as compared to plain wire is shorter.

so many things affecting the length, the only method of resonating a harmonically operated antenna accurately is by cut and try, or by using a feed system in which both feed line and antenna are resonated at the station end as an integral unit.

A dipole or half-wave antenna is said to operate on its fundamental or first harmonic. A full wave antenna, 1 wavelength long, operates on its second harmonic. An antenna with five half-wavelengths on it would be operating on its fifth harmonic. Observe that the fifth harmonic antenna is $2\frac{1}{2}$ wavelengths long, not 5 wavelengths.

The actual physical lengths of harmonically-operated long-wire antennas for the various amateur bands are given in chart form in Section 27-1 of Chapter 27.

Antenna Resonance Most antennas operate most efficiently when tuned or resonated to the frequency of operation. This consideration of course does not apply to the rhombic antenna and to the parasitic elements of arrays employing parasitically excited elements. However, in practically every other case it will be found that increased efficiency results when the entire antenna system is resonant, whether it be a simple dipole or an elaborate array. The radiation efficiency of a resonant wire is many times that of a wire which is not resonant.

If an antenna is slightly too long, it can be resonated by series insertion of a variable capacitor at a high current point. If it is slightly too short, it can be resonated by means of a variable inductance. These two methods, illustrated schematically in Figure 2, are generally employed when part of the antenna is brought into the operating room.

With an antenna array, or an antenna fed by means of a transmission line, it is more common to cut the elements to exact resonant length by "cut and try" procedure. Exact antenna resonance is more important when the antenna system has low radiation resistance; an antenna with low radiation resistance has higher Q (tunes sharper) than an antenna with high radiation resistance. The higher Q does not indicate greater efficiency; it simply indicates a sharper resonance curve.

12-3 Radiation Resistance and Feed-Point Impedance

In many ways, a half-wave antenna is like a tuned tank circuit. The main difference lies in the fact that the elements of inductance, capacitance, and resistance are lumped in the tank circuit, and are distributed throughout the length of an

antenna. The center of a half-wave radiator is effectively at ground potential as far as r-f voltage is concerned, although the current is highest at that point.

When the antenna is resonant, and it always should be for best results, the impedance at the center is a pure resistance, and is termed the radiation resistance. Radiation resistance is a fictitious term; it is that value of resistance (referred to the current loop) which would dissipate the same amount of power that is being radiated by the antenna.

The radiation resistance depends on the antenna length and its proximity to nearby objects which either absorb or re-radiate power, such as the ground, other wires, etc.

The Marconi Antenna Before going too far with the discussion of radiation resistance, an explanation of the Marconi (grounded quarter wave) antenna is in order.

The Marconi antenna is a special type of Hertz antenna in which the earth acts as the "other half" of the dipole. In other words, the current flows into the earth instead of into a similar quarter-wave section. Thus, the current loop of a Marconi antenna is at the base rather than in the center. In either case, it is a quarter wavelength from the end (or ends).

A half-wave dipole far from ground and other reflecting objects has a radiation resistance at the center of about 73 ohms. Radiation resistance usually is referred to a current loop. Otherwise, it has no particular significance, because it could be almost any value if the point on the antenna were not given.

A Marconi antenna is simply one-half of a dipole. For that reason, the radiation resistance is roughly half of 73 ohms.

Antenna Impedance Because the power throughout the antenna is the same, the impedance of the antenna at any point along its length merely expresses the ratio between voltage and current at that point. Thus, the lowest impedance occurs where the current is highest, namely, at the center of a dipole, or a quarter wave from the end of a Marconi. The impedance rises uniformly toward each end, where it is about 2400 ohms for a dipole remote from ground, and about twice as high for a vertical Marconi.

If a vertical half-wave antenna is set up so that its lower end is at the ground level, the effect of the ground reflection is to increase the radiation resistance to approximately 100 ohms. When a horizontal half-wave antenna is used, the radiation resistance (and, of course, the amount of energy radiated for a given antenna current) depends on the height of the antenna above ground, since the height determines the phase angle between the wave radiated directly in any direction and the wave which combines with it after reflection from the ground.

Along a half-wave antenna, the impedance varies from a minimum at the center to a maximum at the ends. The impedance is that property which determines the antenna current at any point along the wire for the value of r-f voltage at that point, assuming a given antenna power.

The curves of Figure 3 indicate the theoretical center-point radiation resistance of a half-wave antenna for various heights above perfect ground. These values are of importance in matching untuned radio-frequency feeders to the antenna, in order to obtain a good impedance match and an absence of standing waves on the feeders.

Above average ground, the actual radiation resistance of a dipole will vary from the exact value of Figure 3, since the latter assumes a hypothetical, perfect ground having no loss and perfect reflection. Fortunately, the curves for the radiation resistance over most types of earth will correspond rather closely with those of the chart, except that the radiation resistance for a horizontal dipole does not fall off as rapidly as

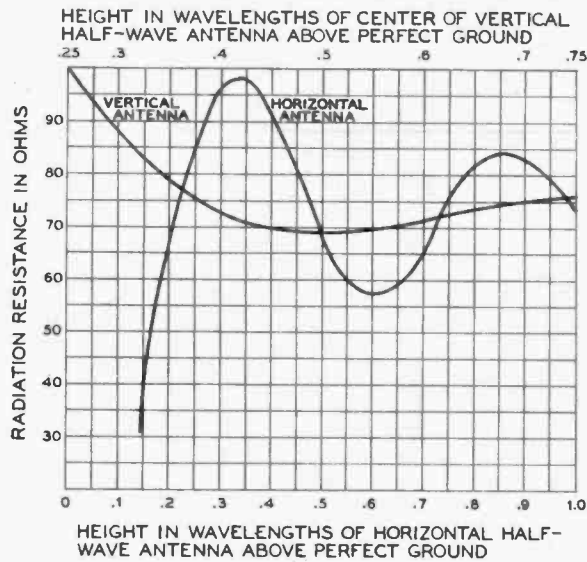

Figure 3. EFFECT OF HEIGHT ON THE RADIATION RESISTANCE OF A DIPOLE SUSPENDED ABOVE PERFECT GROUND.

is indicated for heights below an eighth wavelength. However, with the antenna so close to the ground and the soil in a strong field, much of the radiation resistance is actually represented by ground loss; this means that a good portion of the antenna power is being dissipated in the earth, which, unlike the hypothetical perfect ground, has resistance. In this case, an appreciable portion of the "radiation resistance" actually is loss resistance. The type of soil also has an effect upon the radiation pattern, especially in the vertical plane, as will be seen later.

The radiation resistance of an antenna generally increases with length, although this increase varies up and down about a constantly increasing average. The peaks and dips are caused by the reactance of the antenna, when its length does not allow it to resonate at the operating frequency.

Antenna Efficiency Antennas have a certain loss resistance as well as a radiation resistance. The loss resistance defines the power lost in the antenna due to ohmic resistance of the wire, ground resistance (in the case of a Marconi), corona discharge, and insulator losses.

The approximate effective radiation efficiency (expressed as a decimal) is equal to: $N_r = R_r / (R_r + R_L)$ where R_r is equal to the radiation resistance and R_L is equal to the effective loss resistance of the antenna. The loss resistance will be of the order of 0.25 ohm for large-diameter tubing conductors such as are most commonly used in multi-element parasitic arrays, and will be of the order of 0.5 to 2.0 ohms for arrays of normal construction using copper wire.

When the radiation resistance of an antenna or array is very low, the current at a voltage node will be quite high for a given power. Likewise, the voltage at a current node will be very high. Even with a heavy conductor and excellent insulation, the losses due to the high voltage and current will be appreciable if the radiation resistance is sufficiently low.

Usually, it is not considered desirable to use an antenna or array with a radiation resistance of less than approximately 10 ohms unless there is sufficient directivity, compactness, or other advantage to offset the losses resulting from the low radiation resistance.

Ground Resistance The radiation resistance of a Marconi antenna, especially, should be kept as high as possible. This will reduce the antenna current for a given power, thus minimizing loss resulting from the series resistance

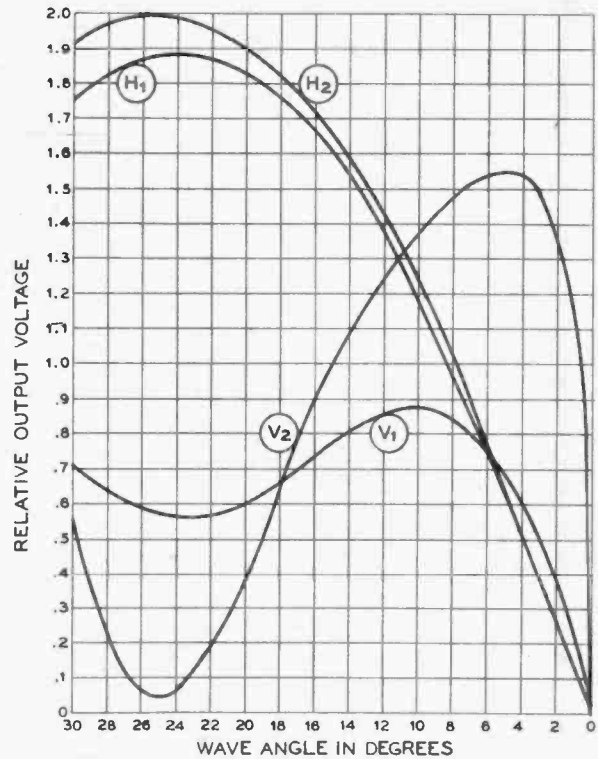

Figure 4. VERTICAL-PLANE DIRECTIONAL CHARACTERISTICS OF HORIZONTAL AND VERTICAL DOUBLET ELEVATED 0.6 WAVELENGTH AND ABOVE TWO TYPES OF GROUND.

H₁ represents a horizontal doublet over typical farmland. H₂ over salt water. V₁ is a vertical pattern of radiation from a vertical doublet over typical farmland, V₂ over salt water. A salt water ground is the closest approach to an extensive ideally perfect ground that will be met in actual practice.

offered by the earth connection. The radiation resistance can be kept high by making the Marconi radiator somewhat longer than a quarter wave, and shortening it by series capacitance to an electrical quarter wave. This reduces the current flowing in the earth connection. It also should be removed from ground as much as possible (vertical being ideal). Methods of minimizing the resistance of the earth connection will be found in the discussion of the Marconi antenna.

12-4 Horizontal Directivity

When choosing and orienting an antenna system, the radiation patterns of the various common types of antennas should be given careful consideration. The directional characteristics are of still greater importance when a directive antenna array is used.

There are two kinds of antenna directivity: horizontal and vertical. Both types of directivity are desirable for amateur work. But vertical directivity is almost a necessity for work on frequencies above about 14 Mc. so this subject will be treated separately in Section 12-5 to follow.

Horizontal directivity is always desirable on any frequency for point-to-point work. However, it is not always attainable with reasonable antenna dimensions on the lower frequencies. Further, when it is attainable, as on the frequencies above 14 Mc., with reasonable antenna dimensions, operating convenience is greatly furthered if the maximum lobe of the horizontal directivity is controllable. It is for this reason that rotatable antenna arrays, as described in detail in Chapter 30, have come into such common usage.

Considerable horizontal directivity can be used to advantage when: (1) only point-to-point work is necessary, (2) several

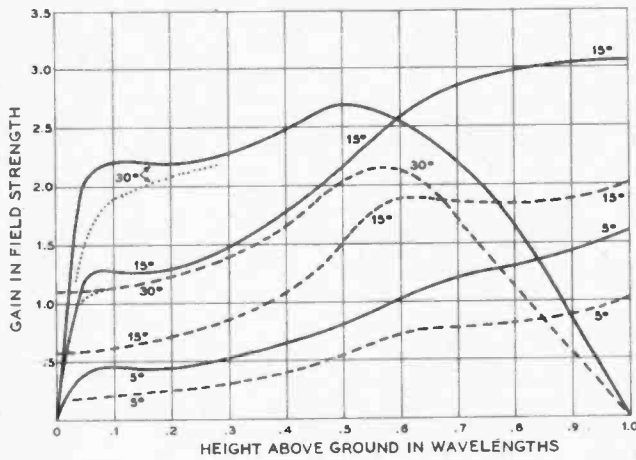

Figure 5.

EFFECT OF HEIGHT UPON ANTENNA GAIN.

Showing the effect of height above ground upon the gain of a horizontal single-section flat-top beam with one-eighth wave spacing (solid curves) and on the gain of a horizontal half-wave dipole antenna (dashed curves) at vertical angles of 5°, 15° and 30°. The gain is referred to a half wave antenna in free space. Perfectly conducting ground is assumed. The short dotted curves show the effect of 0.5-ohm loss resistance on the effective gain of the dipole and the flat-top beam.

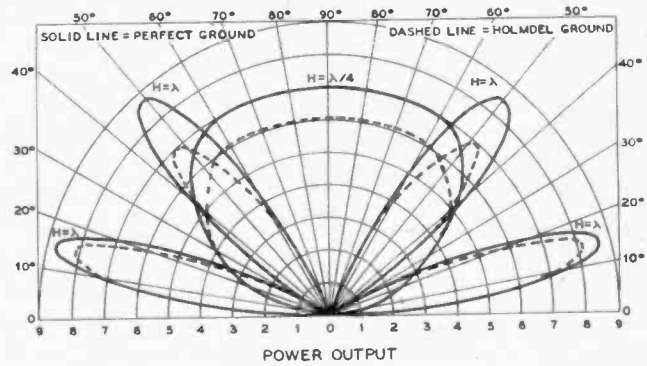

Figure 6.

VERTICAL RADIATION PATTERNS.

Showing the vertical radiation patterns for half-wave antennas (or colinear half-wave or extended half-wave antennas) at different heights above average ground and perfect ground. Note that such antennas one-quarter wave above ground concentrate most radiation at the very high angles which are useful for communication only on the lower frequency bands. Antennas one-half wave above ground are not shown, but the elevation pattern shows one lobe on each side at an angle of 30° above horizontal.

arrays are available so that directivity may be changed by selecting or reversing antennas, (3) a single rotatable array is in use. Signals follow the great-circle path, or within 2 or 3 degrees of that path under all normal propagation conditions. However, under turbulent ionosphere conditions, or when unusual propagation conditions exist, the deviation from the great-circle path for greatest signal intensity may be as great as 90°. Making the array rotatable overcomes these difficulties, but arrays having extremely high horizontal directivity become too cumbersome to be rotated, except perhaps when designed for operation on frequencies above 50 Mc.

Both fixed and rotatable directive arrays for amateur work are described in detail in Chapters 28, 29, and 30.

12-5 Vertical Directivity

As mentioned in Section 12-4, vertical directivity is of the greatest importance in obtaining satisfactory communication on the amateur bands above 14 Mc. whether or not horizontal directivity is used. This is true simply because *only* the energy radiated between certain definite *elevation* angles is useful for communication. Energy radiated at other elevation angles is completely lost and performs no useful function.

Optimum Angle of Radiation The optimum angle of radiation for propagation of signals between two points is dependent upon a number of variables.

Among these significant variables are: (1) height of the ionosphere layer which is providing the reflection, (2) distance between the two stations, (3) number of hops for propagation between the two stations. For communication on the 14-Mc. band it is often possible for different modes of propagation to provide signals between two points. This means, of course, that more than one angle of radiation can be used. If *no* elevation directivity is being used under this condition of propagation, selective fading will take place because of interference between the waves arriving over the different paths.

On the 28-Mc. band it is by far the most common condition that only one mode of propagation will be possible between two points at any one time. This explains, of course, the reason why rapid fading in general and selective fading in par-

ticular are almost absent from signals heard on the 28-Mc. band (except for fading caused by local effects).

Measurements have shown that the angles useful for communication on the 14-Mc. band are from 3° to about 30°—angles above about 15° being useful only for local work. On the 28-Mc. band measurements have shown that the useful angles range from about 3° to 18°—angles above about 12° being useful only for local (less than 3000 miles) work. These figures assume normal propagation by virtue of the *F₂* layer.

Angle of Radiation of Typical Antennas and Arrays

It now becomes of interest to determine the amount of radiation available at these useful lower angles of radiation from antennas and antenna arrays commonly used by amateur stations. Figure 4 shows relative output voltage plotted against elevation angle (wave angle) in degrees above the horizontal, for horizontal and vertical doublets elevated 0.6 wavelength above two types of ground. It is obvious by inspection of the curves that a horizontal dipole mounted at this height above ground (20 feet on the 28-Mc. band) is radiating only a small amount of energy at angles useful for communication on the 28-Mc. band. Most of the energy is being radiated uselessly upward. The vertical antenna above a good reflecting surface appears much better in this respect—and this fact has been proven many times by actual installations. A vertical antenna with its bottom end only about 0.1 wave above a good reflecting surface is an excellent dx antenna. This is true only when a good reflecting surface such as salt marsh, a body of water, or an actual set of copper radials several wavelengths long is available.

It might immediately be thought that the amount of radiation from a horizontal or vertical dipole could be increased by raising the antenna higher above the ground. This is true to an extent in the case of the horizontal dipole; the low-angle radiation does increase *slowly* after a height of 0.6 wavelength is reached but at the expense of greatly increased high-angle radiation and the formation of a number of nulls in the elevation pattern. No signal can be transmitted or received at the elevation angles where these nulls have been formed. Tests have shown that a center height of 0.6 wavelength for a vertical dipole (0.35 wavelength to the bottom end) is about optimum for this type of array.

Figure 5 shows the relative gain in field strength for different elevation angles of radiation for a horizontal dipole at

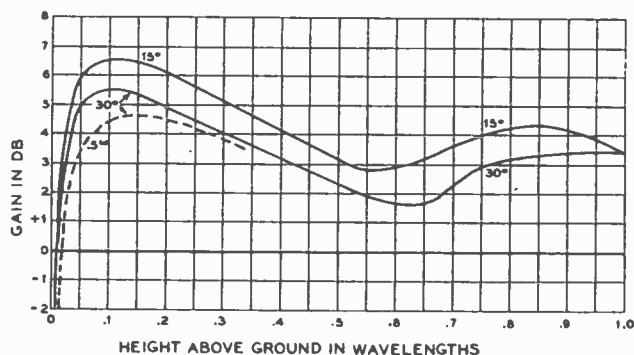

Figure 7.

HEIGHT AGAINST GAIN FOR A FLAT-TOP BEAM.

Showing the effect of height above ground on the gain of a single-section flat-top beam with one-eighth wave spacing over a horizontal half-wave antenna at the same height above ground for vertical angles of 15° and 30°. Multi-section flat top beams will show approximately the same gain over a colinear half-wave antenna of the same overall length for the same height above ground. The effect of 0.5-ohm loss resistance in the flat-top beam is shown by the dashed curve.

different heights above ground. The effect of placing a horizontal dipole still higher above ground is illustrated by Figure 6 showing the vertical radiation pattern of a dipole elevated one wavelength above ground. It is easily seen by reference to Figure 6 (and Figure 8 which shows the radiation from a dipole at $\frac{3}{4}$ wave height) that a large percentage of the total radiation from the dipole is being radiated at relatively high angles which are useless for communication on the 14-Mc. and 28-Mc. bands. Thus we see that in order to obtain a worthwhile increase in the ratio of low-angle radiation to high-angle radiation it is necessary to place the antenna high above ground, and in addition it is necessary to use additional means for suppressing high-angle radiation.

High-angle radiation can be suppressed, and this radiation can be added to that going out at low angles, only through the use of some sort of *directive* antenna system. There are three general types of antenna arrays composed of dipole elements commonly used which concentrate radiation at the lower more effective angles for high-frequency communication. These types are: (1) the close-spaced out-of-phase system as exemplified by the "flat-top beam" or W8JK array, (2) the wide-spaced in-phase system as exemplified by the "lazy-H" and similar arrays, and (3) the close-spaced parasitic system as exemplified by the "three-element rotary" and similar arrays using varying numbers of elements and different spacings.

A comparison between the radiation from a dipole, a "flat-top beam" and a pair of dipoles stacked one above the other (half of a "lazy H"), in each case with the top of the antenna at a height of $\frac{3}{4}$ wavelength is shown in Figure 9. The improvement in the amplitude of low-angle radiation at the expense of the useless high-angle radiation with these simple arrays as contrasted to the dipole is quite marked. The improvement in low-angle radiation with increasing height in the case of an array of the three- or four-element parasitic type is even more marked than in the case of the other two types of antenna configurations. However, actual curves showing angle of elevation against height for these latter types of arrays are not available at this time.

Effect of Average Ground on Antenna Radiation

Articles appearing in journals discussing antenna radiation often are based upon the perfect ground assumption, in order to cover the subject in the most simple manner. Yet, little has been said about the real situation which exists, the ground generally being anything but a perfect con-

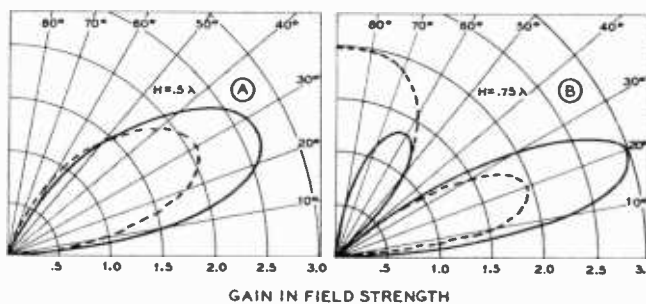

Figure 8.

VERTICAL RADIATION PATTERNS.

Showing vertical-plane radiation patterns of a horizontal single-section flat-top beam with one-eighth wave spacing (solid curves) and a horizontal half-wave antenna (dashed curves) when both are 0.5 wavelength (A) and 0.75 wavelength (B) above ground.

ductor. Consideration of the effect of a ground that is not perfect explains many things.

When the earth is less than a perfect conductor, it becomes a dielectric or, perhaps in an extreme case, a "leaky insulator."

The resulting change in the vertical pattern of a horizontal antenna is shown in Figure 4. The ground constants, in this case, are for flat farmland, which probably is similar to mid-western farmland. The ocean is the closest practical approach to a theoretically perfect ground. It will be noted that there is only a slight loss in power due to the imperfect ground as compared to the ocean horizontal.

The effect of the earth on the radiation pattern of a vertical dipole is much greater. Radiation from a half-wavelength vertical wire is severely reduced by deficiencies of the ground.

A very important factor in the advantages of horizontal or vertical dipoles, therefore, appears to be the condition of the ground.

12-6

Bandwidth

The bandwidth of an antenna or an antenna array is a function primarily of the radiation resistance and of the shape of the conductors which make up the antenna system. For arrays of essentially similar construction the bandwidth (or the deviation in frequency which the system can handle without mismatch) is increased with increasing radiation resistance, and the bandwidth is increased with the use of conductors of larger diameter (smaller ratio of length to diameter). This is

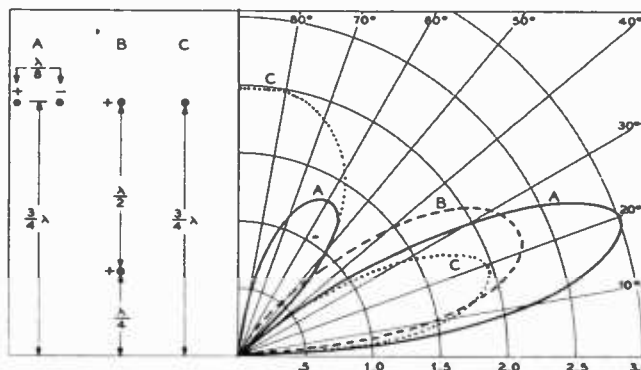

Figure 9.

COMPARATIVE VERTICAL RADIATION PATTERNS.

Showing the vertical radiation patterns of a horizontal single-section flat-top beam (A), an array of two stacked horizontal in-phase half-wave elements—half of a "Lazy H"—(B), and a horizontal dipole (C). In each case the top of the antenna system is 0.75 wavelength above ground, as shown to the left of the curves.

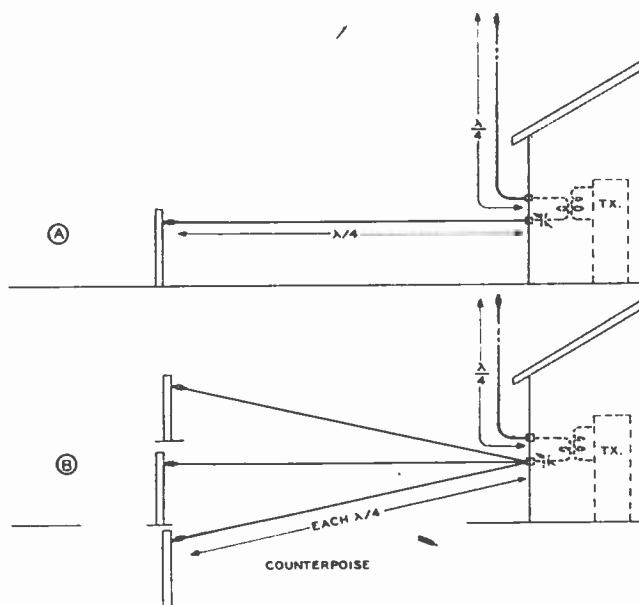

Figure 10.

DIRECTLY-FED ANTENNA SYSTEM.

Showing the "quarter up, quarter out" antenna system in (A), and the "quarter-wave against counterpoise" antenna system at (B). These systems are described in the accompanying text.

to say that if an array of any type is constructed of large diameter tubing or spaced wires, its bandwidth will be greater than that of a similar array constructed of single wires.

This effect is brought out in the case of "close-spaced parasitic beams" or antennas of the "flat-top beam" type. When such arrays are constructed of single wires their bandwidth is narrow enough so that they are incapable of covering an entire band without serious mismatch. But if such arrays are constructed of large-diameter tubing (conventional construction for three-element and four-element rotary types) or of spaced wires ("twin-three flat-top beam") the bandwidth of such systems is increased to the point where a band of the width of the 14-Mc. band may be covered without serious mismatch and approximately one-half of a band of a width such as the 28-Mc. band may be covered adequately.

The radiation resistance of antenna arrays of the types mentioned in the previous paragraph may be increased through the use of wider spacing between elements. With increased radiation resistance in such arrays the "radiation efficiency" increases since the ohmic losses within the conductors becomes a smaller percentage of the radiation resistance, and the bandwidth is increased proportionately. It is for this reason that present design practice in the case of arrays of both the directly-fed and parasitic types is toward the use of spacings between all elements of approximately 0.2 wavelength rather than the spacings earlier used of 0.1 to 0.15 wavelength.

12-7 General Types of Antennas and Arrays

On the 80-meter band little choice exists insofar as the antenna is concerned for the majority of amateur stations. The dimensions required for an antenna array of any marked directional characteristics are so great that an array becomes impracticable for all but those fortunate few who have many acres available. Hence, the average amateur station operating in the 3.5-Mc. to 4.0-Mc. region usually uses some sort of doublet arrangement fed either by a low-impedance or a medium-impedance transmission line. Antennas of this type are discussed in detail in Chapter 27.

On the bands above perhaps 7.0 Mc. somewhat more latitude is possible in choosing an antenna type. The W8JK or flat-top beam becomes practicable and has given excellent results on the 7-Mc. band. Colinear antennas in phase also give excellent results on 40 due primarily to the fact that extremely low angle radiation is not required on this band. For those having adequate space a rhombic or a group of such antennas make an ideal arrangement since the rhombic may be used with excellent results over at least a four-to-one frequency range. Thus a rhombic designed for the 14-Mc. band will give much satisfaction also on the 7-Mc. and 28-Mc. bands.

On the 14-Mc. and 28-Mc. bands any of the antennas previously mentioned can be used, but for best results an antenna having a predominately low angle of maximum radiation must be employed. The two-element, three-element, and four-element parasitic arrays, when installed so as to be rotatable, will give satisfying performance. The flat-top beam or Sterba curtain can also be employed but these types are most likely to require fixed installation and thus can give azimuth directivity in only one, or two opposite, directions. Design data on all common types of high-frequency directive arrays is given in Chapter 28, and rotatable arrays are discussed in detail in Chapter 30.

On the bands above 50 Mc. considerable choice exists in regard to the antenna system since even a multi-element array can be of quite reasonable dimensions. Arrays using many elements to give considerable directivity and gain can be constructed small enough so as to be rotatable with a moderate amount of difficulty. Special arrays for the v-h-f bands are described in Chapter 29.

12-8 Direct Feeding of the Antenna

Under certain conditions, and when interference to broadcast listeners is unlikely, it is practicable to feed an antenna directly. Under these conditions either the center or one end of the antenna is brought directly into the operating room and coupled to the transmitter. The antenna may be either voltage fed or current fed. Methods of voltage feeding the end of the antenna were discussed in Sections 10-4 and 10-5 of Chapter 10. When an antenna is current fed at the end it is called a *Marconi* antenna. Methods of current feeding the end of a *Marconi* antenna are discussed in Chapter 27, *Antennas for the Lower Frequencies*.

An alternative method of directly feeding an antenna is to utilize current feed at the center of the radiator. Methods of feeding an antenna in this manner are shown in Figure 10. Figure 10A shows an arrangement for center feeding a half-wave antenna which was commonly used with good results on the 40-meter band about 20 years ago. It was called a "quarter up and quarter out" antenna system. This arrangement, along with that of Figure 10B, which uses a counterpoise instead of the "quarter out," is quite effective for the amateur who operates primarily on the bands above 28 Mc., but who occasionally desires to operate on 80 and 40. By using both feeders of the v-h-f arrays in parallel as the "quarter up" portion of the system, a counterpoise or "quarter out" may be installed and the two halves of the antenna system series tuned at the operating position by means of a capacitor and a coil inductively coupled to the plate tank circuit of the final amplifier. While these antenna systems can be effective under certain conditions, they afford no harmonic suppression in themselves so that other provisions should be made to insure that harmonic radiation is held to a minimum (Section 10-5). Be sure and check with another amateur a few miles away for harmonic radiation before operating with an antenna system of the type shown in Figure 10.

TRANSMISSION LINES AND ANTENNA MATCHING

For many reasons it is desirable to place an antenna or radiating system as high and in the clear as is physically possible, utilizing some form of nonradiating transmission line to carry energy with as little loss as possible from the transmitter to the radiating antenna, and conversely from the antenna to the receiver.

There are many different types of transmission lines and, generally speaking, practically any type of transmission line or feeder system may be used with any type of antenna. However, mechanical or electrical considerations often make one type of transmission line better adapted for use to feed a particular type of antenna than any other type.

Transmission lines for carrying r-f energy are of two general types: *non-resonant* and *resonant*. A non-resonant transmission line is one on which a successful effort has been made to eliminate reflections from the termination (in this case the antenna) and hence one on which standing waves do not exist or are relatively small in magnitude. A resonant line, on the other hand, is a transmission line on which standing waves of appreciable magnitude do appear, either through inability to match the characteristic impedance of the line to the antenna termination or through intentional design.

The principle types of transmission line in use or available at this time include the open-wire line (2-wire and 4-wire types), 2-wire solid-dielectric line ("twinlead" and similar types), 2-wire polyethylene-filled shielded line, coaxial line of the solid-dielectric, beaded, stub-supported, and pressurized type, rectangular and cylindrical wave guide, and the single-wire feeder operated against ground. The significant characteristics of the more popular types of transmission line available at this time are given in the accompanying chart.

12-9 Untuned Transmission Lines

A nonresonant or untuned transmission line is a line with negligible standing waves. Hence, a nonresonant line is a line carrying r-f power only in one direction—from the source of energy (transmitter) to the load (antenna system).

Physically, the line itself should be *identical throughout its length*. There will be a smooth distribution of voltage and current throughout its length, both tapering off very slightly towards the antenna end of the line as a result of line losses. The attenuation (loss) in certain types of untuned lines can be kept very low for line lengths up to several thousand feet. In other types, particularly where the dielectric is not air (such as in the twisted-pair line), the losses may become excessive at the higher frequencies, unless the line is relatively short.

The termination at the antenna end is the only critical characteristic about the untuned line. It is the reflection from the antenna end which starts waves moving back toward the transmitter end. When waves moving in both directions along a conductor meet, standing waves are set up.

All transmission lines have distributed inductance, capacitance and resistance. Neglecting the resistance, as it is of minor importance in short lines, it is found that the *inductance and capacitance per unit length* determine the characteristic or surge impedance of the line. Thus, the surge impedance depends upon the nature and spacing of the conductors, and the dielectric separating them.

When any transmission line is terminated in an impedance equal to its surge impedance, reflection of energy does not occur, and no standing waves are present. When the load termination is exactly the same as the line impedance, it simply

means that the load takes energy from the line just as fast as the line delivers it, no slower and no faster.

Thus, for proper operation of an untuned line (with standing waves eliminated), some form of impedance-matching arrangement must be used between the transmission line and the antenna, so that the radiation resistance of the antenna is reflected back into the line as a nonreactive impedance equal to the line impedance. It is important that the *radiator itself be cut to exact resonance*; otherwise, it will not present a pure resistive load to the nonresonant line.

An untuned feeder system for amateur use may consist of a coaxial cable or one, two, four, or even more parallel wires. Increased constructional difficulties of the multi-wire type of line, where three or more parallel wires are used, and there is danger of appreciable feeder radiation from an improperly adjusted single-wire feeder, make the more familiar two-wire type of line, either twinlead or air spaced, the most satisfactory for general use.

Semi-Resonant Parallel-Wire Lines A well-constructed open-wire line has acceptably low losses when its length is less than about two wavelengths even

when the voltage standing-wave ratio is as high as 10 to 1. A transmission line constructed of twinlead, however, should have the standing-wave ratio kept down to not less than about 3 to 1 not so much because of overall power loss but because the energy dissipation on the line will be localized, causing overheating of the line at the points of maximum current. The increased power loss resulting from reflections is plotted against voltage-standing-wave ratio in Figure 12. Of much greater importance is to make sure the line is *balanced*, which means that the antenna system must be electrically symmetrical, or allowance made for the asymmetry. If the currents in the two feed wires are not equal in amplitude and exactly opposite in phase, there will be radiation from the line (or pickup by the line if used for receiving), regardless of the amplitude of standing waves.

Because moderate standing waves can be tolerated on open-wire lines without much loss, a standing wave ratio of 2/1 or 3/1 is considered acceptable with this type of line, *even when used in an "untuned" system*. Strictly speaking, a line is un-

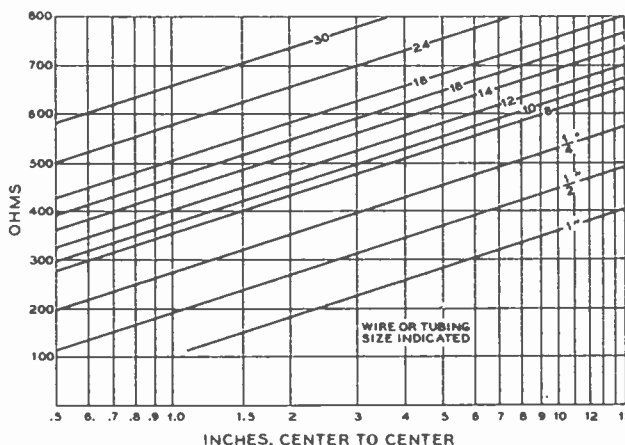

Figure 11. CHARACTERISTIC IMPEDANCE OF CONVENTIONAL TWO-WIRE OPEN LINES CONSTRUCTED OF WIRE OR OF TUBING.

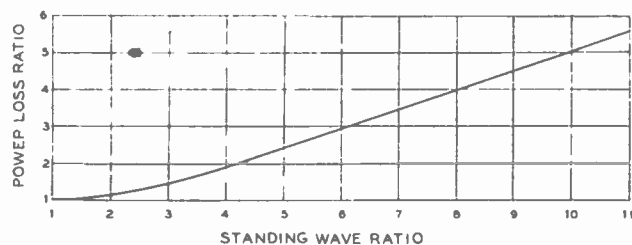

Figure 12.

INCREASED POWER LOSS FROM STANDING WAVES.

Note that this chart cannot be used directly in terms of decibel loss in a transmission line. The decibels loss in the amount of transmission line used if the line were perfectly flat can be determined for the frequency of operation and the "Transmission-Line Characteristics" chart of Figure 12B. Then the decibels loss can be converted to per cent power loss with the aid of the accompanying chart, Figure 12A. When the per cent power loss for flat line has been determined, Figure 12 will give the number of times greater the per cent power loss will be when the standing-wave ratio on the line has been determined.

As an example: A 100-foot transmission line of 300-ohm twinlead is being used on the 14-Mc. band. The loss in this line if it were perfectly flat would be 0.5 db. One-half db loss represents a power loss of 11 per cent. If the line is operating with a standing-wave ratio of 3:1 the power loss ratio is 1.4 so that the resulting power loss in the antenna transmission line would be 1.4 times 11 per cent or 15.4 per cent. In other words the transmission line is operating with an efficiency of 84.6 per cent. If there were no standing waves on the line the efficiency would be 89 per cent.

tuned, or nonresonant, only when it is perfectly "flat," with a standing wave ratio of 1 (no standing waves). However, some mismatch can be tolerated with open-wire untuned lines, so long as the reactance is not objectionable, or is eliminated by cutting the line to approximately resonant length.

Thus, we have a line that is a cross between a tuned and an untuned line. Most of the "untuned" open-wire lines used by amateurs fall in this class, because there is usually more or less of a mismatch at the line termination. *Open-wire* lines with a standing wave ratio of less than 3/1 may be classed as *nonresonant*, or untuned, lines, as standing waves will not seriously affect the operation of an untuned line unless greater than this in magnitude.

The foregoing applies only to *open-wire lines*. The losses in other type lines, especially those having rubber dielectric, go up rapidly with the standing wave ratio, such lines being designed for perfectly "flat" operation. Also, the maximum power handling capability of lines is greatly reduced when standing waves are present, even though of only 2/1 or 3/1 magnitude. The power handling capability of an open line will still be very high, but other lines do not have such a high capability to begin with, and if being worked at full rated power may be punctured or overheated by the presence of moderate standing waves. From this we can see that every attempt should be made to eliminate all traces of standing waves on a low impedance, close-spaced line, especially when the power is high enough that there is danger of arc-over at voltage loops, or when the frequency is high enough that the losses are already so great that increased losses will be a serious item.

12-10 Construction of Two-Wire Open Lines

A two-wire transmission system is easy to construct. Its surge impedance can be calculated quite easily, and when properly adjusted and balanced to ground, undesirable feeder radiation is minimized; the current flow in the adjacent wires is in opposite directions, and the magnetic fields of the two wires are in opposition to each other. When a two-wire line is terminated with the equivalent of a pure resistance equal to the surge impedance of the line, the line becomes a non-resonant line.

It can be shown mathematically that the true surge im-

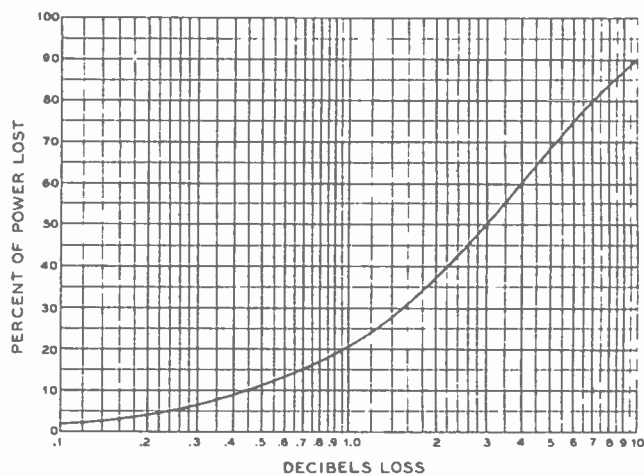

Figure 12A.

TRANSMISSION-LINE CHARACTERISTICS						
TRANSMISSION LINE	Z ₀	IMP./FOOT	V _F	OVERALL DIMENSIONS	ATTENUATION DB/100 FT.-MC.	
2-WIRE OPEN LINE	450-650		0.98	2" TO 6"	3.5	7 14 28 50 144 235
4-WIRE OPEN LINE	175-300		0.96	2" TO 7"	0.035	0.08 0.07 0.1 0.13 0.22 0.29
PARALLEL DURAL TUBES	175-300		0.95	2" TO 4"	LESS THAN 2-WIRE OPEN LINE	
PARALLEL LAMP CORD	125 APP.		0.85	0.3"	GREATER THAN 75 Ω RX TWINLEAD	
300-OHM TWINLEAD	300	5.8	0.82	0.4"	0.23	0.35 0.5 0.82 1.2 2.8 4.5
150-OHM TWINLEAD	150	10	0.77	0.22"	0.28	0.4 0.6 1.0 1.6 3.9 6.0
75-OHM TWINLEAD, RX	75	19	0.69	0.125"	0.4	0.65 1.1 1.9 3.0 6.5 10.0
75-OHM TWINLEAD, TX	75		0.71	0.4	BETWEEN 75 AND 150-OHM RX TYPE	
RG 8/U	52	28.5	0.66	.405"	0.29	0.41 0.65 1.0 1.4 2.6 3.4
RG 11/U	75	20.5	0.66	.405"	0.26	0.4 0.64 0.99 1.3 2.4 3.1
RG 58/U	52	28.5	0.66	.195"	0.55	0.6 1.3 1.9 2.6 5.3 7.0
RG 59/U	75	21.0	0.66	.242"	0.85	0.6 1.3 1.8 2.7 5.0 6.3

Figure 12B.

pedance of any two-wire parallel line system is approximately equal to

$$Z_s = 276 \log_{10} \frac{2S}{d}$$

Where:

S is the exact distance between wire centers in some convenient unit of measurement, and

d is the diameter of the wire measured in the same units as the wire spacing, S.

Since $\frac{2S}{d}$ expresses a ratio only, the units of measurement

may be centimeters, millimeters, or inches. This makes no difference in the answer, so long as the substituted values for S and d are in the same units.

The equation is accurate so long as the wire spacing is relatively large as compared to the wire diameter.

Surge impedance values of less than 200 ohms are seldom used in the open-type two-wire line, and, even at this rather high value of Z_s, the wire spacing S is uncomfortably close, being only 5.3 times the wire diameter d.

Figure 11 gives in graphical form the surge impedance of any practicable two-wire line. The chart is self-explanatory, and sufficiently accurate for practical purposes.

Four-Wire Open-Wire Lines Under certain conditions it is desirable to have the power-handling capacity of an open-wire line and yet have a line whose characteristic impedance is of the order of 200 ohms rather

Z ₀ OHMS	№ 12 WIRE			№ 14 WIRE		
	COL. 1 SPACING INCHES	COL. 2 SPACING INCHES	COL. 3 CIR. DIA. INCHES	COL. 4 SPACING INCHES	COL. 5 SPACING INCHES	COL. 6 CIR. DIA. INCHES
175	1.415	1 1/8	2.001	1.120	1 1/8	1.585
184	1.495	1 1/8	2.110	1.185	1 3/16	1.675
187	1.535	1 3/16	2.175	1.215	1 1/8	1.720
193	1.630	1 3/8	2.305	1.280	1 3/16	1.820
200	1.720	1 3/8	2.434	1.361	1 3/8	1.935
202	1.820	1 1/2	2.560	1.440	1 3/8	2.100
203	1.820	1 1/2	2.560	1.440	1 3/8	2.100
206	2.020	2	2.858	1.600	1 3/8	2.261
207	2.020	2	2.858	1.600	1 3/8	2.261
210	2.120	2 1/8	3.000	1.630	1 1/2	2.378
211	2.120	2 1/8	3.000	1.630	1 1/2	2.378
212	2.301	2 3/8	3.122	1.825	1 13/16	2.581
216	2.301	2 3/8	3.122	1.825	1 13/16	2.581
219	2.420	2 3/8	3.421	1.920	1 13/16	2.719
223	2.662	2 1/2	3.700	2.110	1 1/2	2.890
224	2.662	2 1/2	3.700	2.110	1 1/2	2.890
225	2.910	2 13/16	4.110	2.310	2 3/16	3.375
228	2.910	2 13/16	4.110	2.310	2 3/16	3.375
232	3.075	3 1/8	4.350	2.435	2 1/2	3.440
234	3.150	3 1/8	4.450	2.497	2 1/2	3.530
238	3.320	3 3/8	4.690	2.625	2 3/8	3.720
240	3.420	3 3/8	4.835	2.721	2 11/16	3.853
245	3.640	3 3/4	5.150	2.881	2 3/4	4.075
250	4.040	4 1/8	5.710	3.204	3 3/8	4.540
256	4.360	4 3/8	6.160	3.460	3 3/8	4.890
261	4.650	4 3/4	6.580	3.683	3 11/16	5.202

Figure 13.
FOUR-WIRE LINE DESIGN TABLE.

Sections of four-wire open line can be used very conveniently as quarter-wave matching sections as described in the text. Note that "COL. 5" for the impedance range "223, 224, 225 ohms" should read 2 1/8 inches rather than 1 1/8 inches as shown.

than being in the vicinity of 500 ohms for practicable two-wire lines. The four-wire open line has this lowered characteristic impedance and has been used in many applications as a quarter-wave matching transformer (Q section). Design data for four-wire lines is given in Figure 13. The four wires of such a transmission line are spaced on the corners of a square (or equally spaced on the circumference of a circle) and opposite wires are connected together at each end of the line. Make sure that the same wires are paralleled at each end of the transmission line section.

The spacers for the line can be constructed from crossed strips of polystyrene cemented with polystyrene cement or of crossed strips of lucite cemented with chloroform. Plastic iced-tea coasters of suitable diameter can also be used as spacers. Experience has indicated that the spacers should be placed every 2 or 3 feet along the line and that the line should be operated under some tension to prevent twisting. The application of such low-impedance lines to the function of impedance matching is discussed in Section 12-12 of this chapter.

Coaxial Line Several types of coaxial cable have come into wide use for feeding power to an antenna system. A cross-sectional end view of a coaxial cable (sometimes called concentric cable or line) is shown in Figure 14.

As in the parallel-wire line, the power lost in a properly terminated coaxial line is the sum of the effective resistance losses along the length of the cable and the dielectric losses between the two conductors. In a well designed line using air or nitrogen as the dielectric, both are negligible, the actual measured loss in a good line being less than 0.5 db per 1000 feet at 1 megacycle.

Of the two losses, the effective resistance loss is the greater; since it is largely due to the skin effect, the line loss (all other

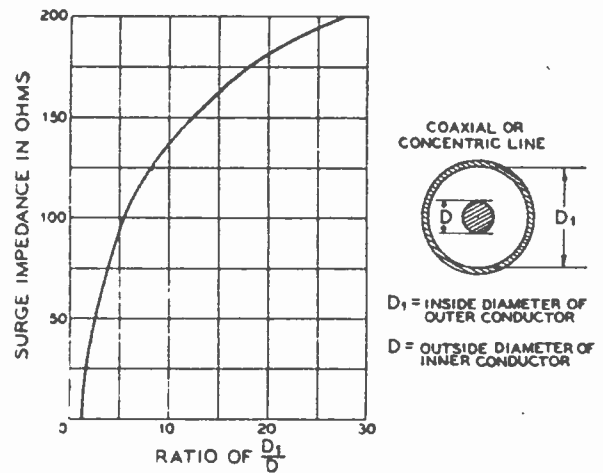

Figure 14.
CURVE FOR DETERMINATION OF SURGE IMPEDANCE OF ANY COAXIAL LINE HAVING AIR DIELECTRIC.
Presence of spacing insulators will lower the impedance somewhat below the calculated value as derived from this chart.

conditions the same) will increase directly as the square root of the frequency.

Figure 14 shows that, instead of having two conductors running side by side, one of the conductors is placed inside the other. Since the outside conductor completely shields the inner one, no radiation takes place. The conductors may both be tubes, one within the other; the line may consist of a solid wire within a tube, or it may consist of a stranded or solid inner conductor with the outer conductor made up of one or two wraps of copper shielding braid.

In the type of cable most popular for amateur use the inner conductor consists of a heavy stranded wire, the outer conductor consists of a braid of copper wire, and the inner conductor is supported within the outer by means of a semi-solid dielectric of exceedingly low loss characteristics called polyethylene. The Army-Navy designation on one size of this cable suitable for power levels up to one kilowatt at frequencies as high as 30 Mc. is AN/RG-8/U. The outside diameter of this type of cable is approximately one-half inch. The characteristic impedance of this cable type is 52 ohms, but other similar types of greater and smaller power-handling capacity are available in impedances of 75 and 95 ohms.

When using coaxial cable it is necessary that precautions be taken to insure that moisture cannot enter the line. If the better grade of connectors manufactured for the line are employed as terminations, this condition is automatically satisfied. If connectors are not used, it is necessary that some type of moisture-proof sealing compound be applied to the end of the cable where it will be exposed to the weather.

Nearby metallic objects cause no loss, and coaxial cable may be run up air ducts, wire conduit, or elevator shafts. Insulation troubles can be forgotten. The coaxial cable may be buried in the ground or suspended above ground.

Coaxial cable, like twisted-pair cable, is most commonly used without a matching system. Cable is chosen to have a surge impedance that approximates the terminal radiation resistance of the antenna (point at which the line is connected).

While coaxial cable is best suited to use with ground-plane vertical antennas, because the outside conductor is ordinarily grounded, it can be used successfully to feed a balanced dipole. This is permissible because the impedance is low, and therefore no great unbalance results from such operation. The outer conductor of the coaxial cable connects to one half the

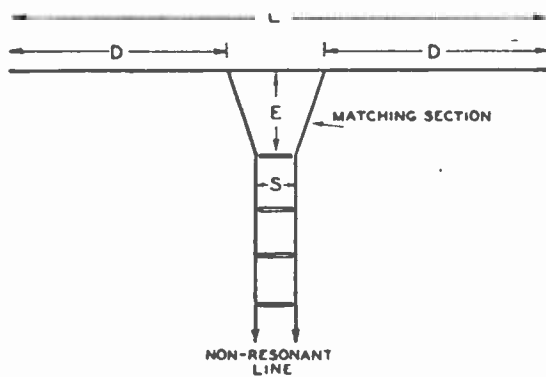

Figure 15.

THE DELTA-MATCHED ANTENNA SYSTEM.

This system is sometimes called a "Y matched" doublet. For dimensions refer to formula in text.

dipole, and the inner conductor connects to the other half. In this case, the outer conductor is often left ungrounded.

12-11 Tuned or Resonant Lines

If a transmission line is terminated in its *characteristic surge impedance*, there will be no reflection at the end of the line, and the current and voltage distribution will be uniform along the line. If the end of the line is either open-circuited or short-circuited, the reflection at the end of the line will be 100 per cent, and *standing waves* of very great amplitude will appear on the line. There will still be practically no radiation from the line, but voltage nodes will be found along the line, spaced a half wavelength. Likewise, voltage loops will be found every half wavelength, the voltage loops corresponding to current nodes.

If the line is terminated in some value of resistance other than the characteristic surge impedance, there will be some reflection, the amount being determined by the amount of mismatch. With reflection, there will be standing waves (excursions of current and voltage) along the line, though not to the same extent as with an open-circuited or short-circuited line. The current and voltage loops will occur at the same *points* along the line as with the open- or short-circuited line, and as the terminating impedance is made to approach the characteristic impedance of the line, the current and voltage along the line will become more uniform. The foregoing assumes, of course, a purely resistive (nonreactive) load.

A well built 500- to 600-ohm transmission line may be used as a resonant feeder for lengths up to several hundred feet with very low loss, so long as the amplitude of the standing waves (ratio of maximum to minimum voltage along the line) is *not too great*. The amplitude, in turn, depends upon the mismatch at the line termination. A line of no. 12 wire, spaced 6 inches with good ceramic or plastic spreaders, has a surge impedance of approximately 600 ohms, and makes an excellent tuned feeder for feeding anything between 60 and 6000 ohms (at frequencies below 30 Mc.). If used to feed a load of higher or lower impedance than this, the standing waves become great enough in amplitude that some loss will occur unless the feeder is kept short. At frequencies above 30 Mc., the spacing becomes an appreciable fraction of a wavelength, and radiation from the line no longer is negligible.

If a transmission line is not perfectly matched, it should be made *resonant*, even though the amplitude of the standing waves (voltage variation) is not particularly great. This prevents reactance from being coupled into the final amplifier. A feed system having moderate standing waves may be made to present a nonreactive load to the amplifier either by tuning or by pruning the feeders to approximate resonance.

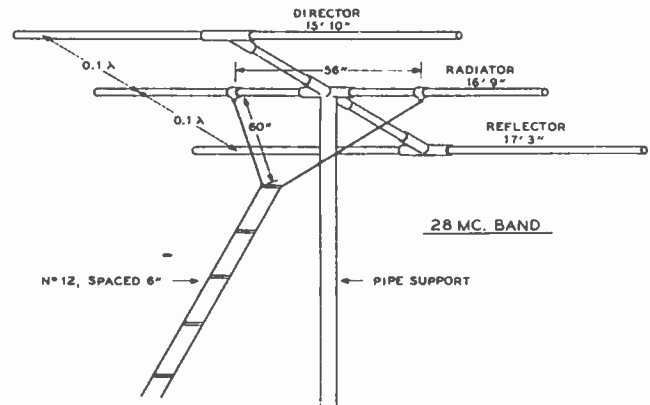

Figure 16.

APPLICATION OF "DELTA-MATCH" SYSTEM FOR FEEDING A THREE-ELEMENT "PLUMBERS-DELIGHT" TYPE OF ROTARY.

Usually it is preferable with tuned feeders to have a current loop (voltage minimum) at the transmitter end of the line. This means that when voltage-feeding an antenna, the tuned feeders should be made an odd number of quarter wavelengths long, and when current-feeding an antenna, the feeders should be made an even number of quarter wavelengths long. Actually, the feeders are made about 10 per cent of a quarter wave longer than the calculated value (the value given in the tables) when they are to be series tuned to resonance by means of a capacitor, instead of being trimmed and pruned to resonance.

When tuned feeders are used to feed an antenna on more than one band, it is necessary to compromise and make provision for both series and parallel tuning, inasmuch as it is impossible to cut a feeder to a length that will be optimum for several bands. If a voltage loop appears at the transmitter end of the line on certain bands, parallel tuning of the feeders will be required in order to get a transfer of energy. It is impossible to transfer energy by inductive coupling unless current is flowing. This is effected at a voltage loop by the presence of the resonant tank circuit formed by parallel tuning of the antenna coil.

12-12 Matching Nonresonant Lines to the Antenna

From the standpoint of economy and efficiency, the most practical untuned line is a parallel-wire line having a surge impedance of from 300 to 600 ohms. Unfortunately, it is seldom that the antenna system being fed has an impedance of similar value either at a current loop or at a voltage loop. It is sometimes necessary, with current-fed antennas, to match the line to an impedance as low as 8 or 10 ohms, while with voltage-fed antenna systems and arrays, it is occasionally necessary to match the line to an impedance of many thousands of ohms. There are many ways of accomplishing this, the more common and most satisfactory methods being discussed here.

Delta-Matched Antenna System The delta type matched-impedance antenna system is shown in Figure 15. The impedance of the transmission line is transformed gradually into a higher value by the fanned-out Y portion of the feeders, and the Y portion is tapped on the antenna at points where the antenna impedance is a compromise between the impedance at the ends of the Y and the impedance of the unfanned portion of the line.

The constants of the system are rather critical, and the antenna must resonate at the operating frequency in order to

minimize standing waves on the line. Some slight readjustment of the taps on the antenna is desirable, if appreciable standing waves persist in appearing on the line. It is almost impossible to get the standing wave ratio below 2/1 with this system, and as standing waves of this order are not objectionable on an open line if it is cut to such a length that it is non-reactive, this ratio is considered as indicating the best match that can be expected with a "Y" or delta-matched doublet.

The constants are determined by the following formulas:

$$L_{feet} = \frac{467.4}{F_{\text{megacycles}}}$$

$$D_{feet} = \frac{175}{F_{\text{megacycles}}}$$

$$E_{feet} = \frac{147.6}{F_{\text{megacycles}}}$$

where L is antenna length; D is the distance *in from each end* at which the Y taps on; E is the height of the Y section.

As these constants are correct only for a 600-ohm transmission line, the spacing S of the line must be approximately 75 times the diameter of the wire used in the transmission line. For no. 14 B & S wire, the spacing will be slightly less than 5 inches. For no. 12 B & S, the spacing should be 6 inches. This system should never be used on either its even or odd harmonics, as entirely different constants are required when more than a single half wavelength appears on the radiating portion of the system.

Using Delta Match to Parasitic Arrays The delta match is one of the two most popular systems for feeding a parasitic array such as the three-element and four-element rotaries. The other commonly-used system is the T-match which is discussed in the following section. Experience has shown that the adjustment for accurate match between the transmission line and the driven element of the array must be made by the cut-and-try process for minimum standing waves. An adjustment which has given low standing waves on a 480-ohm line (no. 12 wire spaced 2 inches) is to have the line tapped on 24 inches each side of the center of the array, with the drop to the first spreader (dimension E in Figure 15) of about 40 inches. These dimensions are for a 28-Mc. three-element parasitic array with 0.15 wavelength spacing between driven element and either of the other two elements. These dimensions can be used as a starting point, and the exact adjustment determined by cut-and-try from these dimensions. The dimensions should of course be doubled for a 14-Mc. array.

Multi-Wire Doublets When a doublet antenna or the driven element in an array consists of more than one wire or tubing conductor the radiation resistance of the antenna or array is increased slightly as a result of the increase in the effective diameter of the element. Further, if we split just one wire of such a radiator, as shown in Figure 17, the effective *feed-point* resistance of the antenna or array will be increased by a factor of N^2 where N is equal to the number of conductors, all in parallel, of the same diameter in the array. Thus if there are two conductors of the same diameter in the driven element or the antenna the feed point resistance will be multiplied by 2² or 4. If the antenna has a radiation resistance of 75 ohms its feed-point resistance will be 300 ohms—this is the case of the conventional *folded-dipole* as shown in Figure 17B. It is common practice to construct a folded dipole of 300-ohm twinlead both for the flat top and for the feeder. The length of the flat top is calculated in the conventional manner as though wire were being used since the two conductors in the flat top are essentially at the same r-f potential—

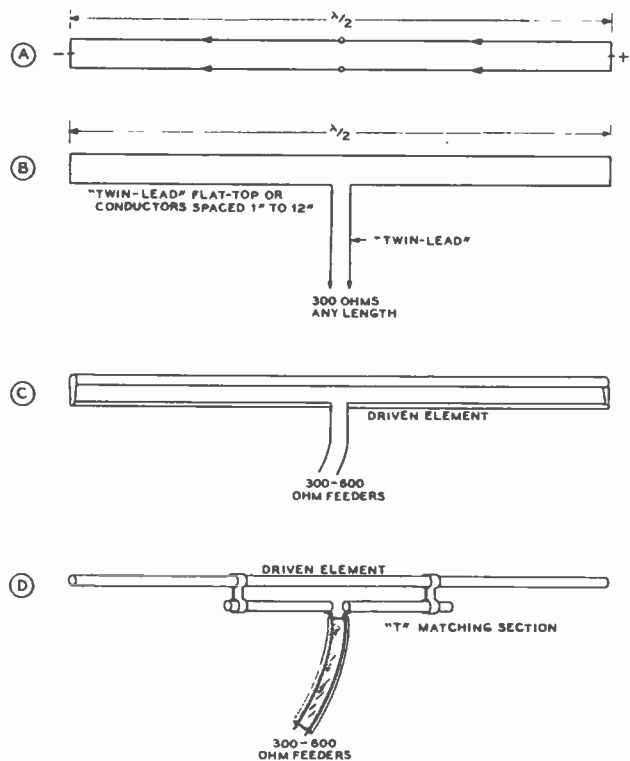

Figure 17. DEVELOPMENT OF "T-MATCH" SYSTEM FOR FEEDING DRIVEN ELEMENT OF PARASITIC CLOSE-SPACED ARRAY.

Drawing (A) above shows a half-wave doublet made up of two parallel wires. If one of the wires is broken as in (B) and the feeder connected, the feed-point impedance is multiplied by four; such an antenna is commonly called a "folded doublet". The feed-point impedance for a simple half-wave doublet fed in this manner is approximately 300 ohms, depending upon antenna height. Drawing (C) shows how the feed-point impedance can be multiplied by a factor greater than four by making the half of the element that is broken smaller in diameter than the unbroken half. An extension of the principles of (B) and (C) is the arrangement shown at (D) where the section into which the feeders are connected is considerably shorter than the driven element. This system is most convenient when the driven element is too long (such as for a 28-Mc. or 14-Mc. array) for a convenient mechanical arrangement of the system shown at (C). Suggested dimensions for the "T-match" section of (D) are given in the text.

hence the lowered velocity of propagation characteristic of twinlead when it is used as a *feeder*, where the two leads of the feeder are 180° out of phase, does not apply when twinlead is used as the flat top in a folded dipole. The equation for calculating antenna length was given in several forms in Section 12-1 at the first of this chapter. The two conductors at each end of the twinlead flat top are connected together, and one of the conductors in the center of the flat top is broken and the two leads thus obtained are connected to the 300-ohm twinlead transmission line going to the transmitter.

If three wires are used in the driven radiator the feed-point resistance is increased by a factor of 9; if four wires are used the impedance is increased by a factor of 16, and so on. In certain cases when feeding a parasitic array it is desirable to have an impedance step up different from the value of 4:1 obtained with two elements of the same diameter and 9:1 with three elements of the same diameter. Intermediate values of impedance step up may be obtained by using two elements of different diameter for the complete driven element as shown in Figure 17C. If the conductor that is broken for the feeder is of *smaller* diameter than the other conductor of the radiator, the impedance step up will be *greater* than 4:1. On the other

hand if the *larger* of the two elements is broken for the feeder the impedance step up will be *less* than 4:1.

As an example of the use of the system shown in Figure 17C, the following parasitic array was tested: frequency, 50-Mc. band; 0.2 wavelength spacing between reflector and driven element, between driven element and first director, and between first and second director. With the driven element and all parasitic elements constructed from 1-inch dural tubing, and with a full-length piece of quarter-inch copper tubing below the driven element as shown in Figure 17C, an excellent match with low standing waves was obtained with 300-ohm twinlead feeder connected in the center of the piece of 1/4-inch copper tubing. The spacing between the outsides of the 1/4-inch section and the 1-inch section of the driven element was 1 inch. Should this array be scaled up or down for use on another band the dimensions for the diameters and spacing for the two pieces which make up the driven element should not be changed.

The "T" Match A method of matching a low-impedance transmission line to the driven element of a parasitic array which is meeting with increasing favor is the "T" match as illustrated in Figure 17D. This method is an adaptation of the multi-wire doublet principle which is more practicable for lower-frequency parasitic arrays such as those for use on the 14-Mc. and 28-Mc. bands. In the system a section of tubing of the same diameter as the driven element is spaced about 1 inch from the driven element by means of clamps which hold the "T" section mechanically and which make electrical connection to the driven element. The length of the "T" section is normally between 24" and 40" each side of the center of the driven dipole for the case of feeding a 3- or 4-element array from 300- to 600-ohm transmission line when the array is operating on the 28-Mc. band. These dimensions either side of center are of course doubled for the 14-Mc. band. It is well to allow for an adjustment out to 4 feet either side of center on the "T" section for a 28-Mc. antenna.

One particular array constructed for the 28-Mc. band ended up with the following dimensions for minimum standing waves of a 300-ohm twinlead feeder: three-element array with 0.2 spacing between elements; tubing diameter for all elements, 1 1/2-inch dural; spacing between "T" section and driven element, 2"; gap between inside faces of "T" section where feeder is attached, 1/2 inch; length of "T" section either side of center 40".

Single-Wire-Fed Antenna If one wire is removed from the delta-matched impedance antenna of Figure 15 and the remaining feeder is moved along the doublet to the point giving the lowest standing-wave ratio on the single feed wire, the system will still work satisfactorily. However, there will be an appreciable amount of radiation from the feeder, even with the best possible match, and for this reason a single-wire feeder is never used to feed directive antenna arrays, and is used primarily for portable and emergency work.

A single-wire feed line has a characteristic surge impedance of from 500 to 600 ohms, depending upon the diameter of the feeder wire. This type feeder makes use of the earth as a return circuit through the earth's capacitance effect to the antenna and feeder. The actual earth connection to the transmitter may have a relatively high resistance without causing appreciable loss of r-f energy.

The feeder is normally attached to the radiator about 1/6 or 1/7 of a half wavelength from the center.

The single-wire-fed antenna not only works well on its fundamental, but is a good radiator on its various harmonics. For this reason, this type antenna system should not be used

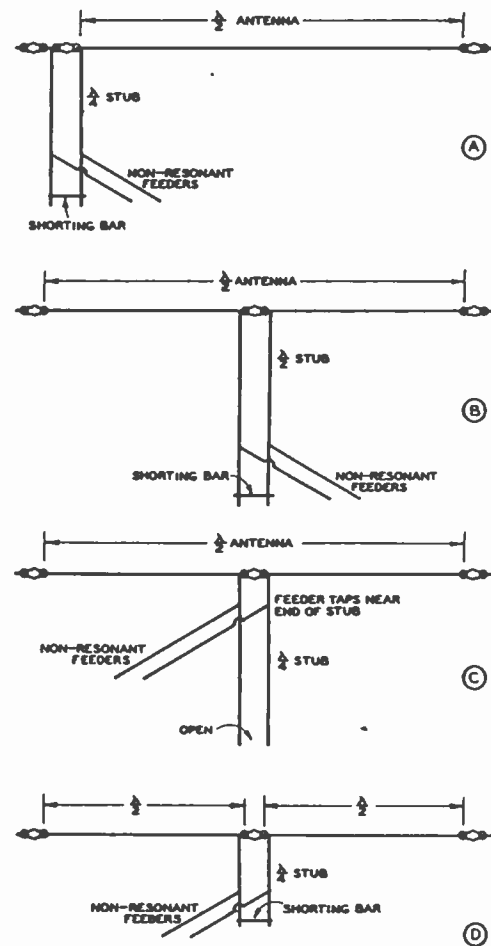

Figure 18.
MATCHING-STUB APPLICATIONS.

- (A) Half-wave antenna with quarter-wave matching stub.
 (B) Center-fed half-wave antenna with half-wave matching stub.
 (C) Center-fed half-wave antenna with stub line cut to exact length without shorting bar.
 (D) Two half-wave sections in phase with quarter-wave stub.

on the low- and medium-frequency bands, unless a harmonic-suppressing antenna coupler is used to prevent radiation of harmonics.

A single-wire feeder also can be used to feed a quarter-wave vertical Marconi radiator. The best point of attachment for the feeder should be determined by cut and try. Normally it will be about 1/3 of the way up the radiator.

12-13

Matching Stubs

By hanging a resonant length of Lecher wire line (called a matching stub) from either a voltage or current loop and attaching parallel-wire nonresonant feeders to the resonant stub at a suitable voltage (impedance) point, standing waves on the line may be virtually eliminated. The stub is made to serve as an autotransformer. Thus, by putting up a half-wave zapp with quarter-wave feeders at a distance from the transmitter, and attaching a 600-ohm or 300-ohm line from the transmitter to the zapp feeders at a suitable point, we have a stub-matched antenna. The example cited here is commonly called a J antenna, especially when both radiator and stub are vertical. Many variations from this example are possible; stubs are particularly adapted to matching an open line to certain directional arrays, as will be described later.

Voltage Feed When the stub attaches to the antenna at a voltage loop, the stub should be a quarter

wavelength long electrically, and be shorted at the bottom end. The stub can be resonated by sliding the shorting bar up and down before the nonresonant feeders are attached to the stub, the antenna being shock-excited from a separate radiator during the process. Slight errors in the length of the radiator can be compensated for by adjustment of the stub if both sides of the stub are connected to the radiator in a symmetrical manner. Where only one side of the stub connects to the radiating system, as in the J antenna example given here, the radiator length must be exactly right in order to prevent excessive unbalance in the untuned line.

If only one leg of a stub is used to voltage-feed a radiator, it is impossible to secure a perfect balance in the transmission line due to a slight inherent unbalance in the stub itself when one side is left floating. This unbalance should not be aggravated by a radiator of improper length.

Current Feed When a stub is used to current-feed a radiator, the stub should either be left *open* at the bottom end instead of shorted, or else made a *half wave* long. The open stub should be resonated in the same manner as the shorted stub before attaching the transmission line; however, in this case, it is necessary to prune the stub to resonance, as there is no shorting bar.

Sometimes it is handy to have a stub hang from the radiator to a point that can be reached from the ground, in order to facilitate adjustment of the position of the transmission-line attachment. For this reason, a quarter-wave stub is sometimes made three-quarters wavelength long at the higher frequencies, in order to bring the bottom nearer the ground. Operation with any *odd* number of quarter waves is the same as for a quarter-wave stub.

Any number of *half waves* can be added to either a quarter-wave stub or a half-wave stub without disturbing the operation, though losses will be lowest if the shortest usable stub is employed. This can be fully understood by inspection of the accompanying table.

Stub Length (Electrical)	Current-Fed Radiator	Voltage-Fed Radiator
1/4-3/4-1 1/4-etc. wavelengths	Open	Shorted
1/2-1-1 1/2-2-etc. wavelengths	Shorted	Open

Shorted-Stub Tuning Procedure When the antenna requires a shorted stub (odd number of quarter waves if the antenna is voltage-fed, or an even number if the radiator is current-fed), the tuning procedure is as follows:

Shock-excite the radiator (or one of the half-wave sections, if harmonically operated) by means of a makeshift doublet strung directly underneath where possible, and just off the ground a few inches, connected to the transmitter by means of any kind of twisted-pair or open line handy.

With the feeders and shorting bar disconnected from the stub, slide along an r-f milliammeter or low-current dial light at about where you calculate the shorting bar should be, and find the point of maximum current (in other words, use the meter or lamp as a shorting bar).

MAKE SURE IT IS IMPOSSIBLE FOR PLATE VOLTAGE TO BE ON THE FEED LINE BEFORE ATTEMPTING THIS PROCEDURE. *Inductive coupling to the final amplifier by means of a few turns of high tension ignition wire is recommended during any tuning-up process where the operator must come in contact with the antenna or feeders.*

It is best to start with reduced power to the transmitter, until you see how much of an indication you may expect; otherwise,

the meter or lamp may be blown on the initial trial. The lamp or meter leads should be no longer than necessary to reach across the stub.

After finding the point of maximum current, remove the lamp or meter and connect a piece of wire across the stub at that point.

Starting at a point about a quarter of a quarter wave (8 feet at 40 meters) from the shorting bar, connect the feeders to the stub. Then, move the feeders up and down the stub until the standing waves on the line are at a minimum. The makeshift doublet should, of course, be disconnected and the regular feeders connected to the transmitter during this process. Slight readjustment of the shorting bar will usually result in further improvement.

The standing wave indicator may be either a voltage device, such as a neon bulb, or a current device, such as an r-f milliammeter connected to a pickup coil. A high degree of accuracy is not required.

The following rule will indicate in which direction the feeders should be moved in an attempt to minimize standing waves: If the current increases on the transmission line as the indicator is moved away from the point of attachment to the stub, the feeders are attached too far from the shorting bar, and must be moved closer to the shorting bar; if the current decreases, the feeders must be attached farther from the shorting bar.

Open-Ended Stub Tuning Procedure If the antenna requires an open stub (even number of quarter waves if the antenna is voltage-fed, odd number of quarter waves if it is current-fed), the tuning procedure is as follows:

Shock-excite the radiator as described for tuning a shorted-stub system, feeders disconnected from the stub, and stub cut slightly longer than the calculated value. Place a field strength meter (the standing wave indicator can be very easily converted into one by addition of a tuned tank) close enough to one end of the radiator to get a reading, and as far as possible from the makeshift exciting antenna. Now, start folding and clipping the stub wires back on themselves a few inches at a time, effectively shortening their length, until you find the peak as registered on the field meter.

Next, attach the feeders to the stub as described for the shorted-stub system, but, for the initial trial connection, the feeders will attach at a distance more nearly three-quarters of a quarter wave from the end of the stub instead of a quarter of a quarter wave, as is the case for a shorted stub. After attaching the feeders, move them along the stub as necessary to minimize standing waves on the line. If sliding the feeders along the stub a few inches makes the standing waves worse, it means the correct connecting point is in the other direction.

After the optimum point on the stub is found for the feeder attachment, the length of the stub can be "touched up" for a final adjustment to minimize standing waves. This is advisable because the attachment of the feeder often detunes the stub slightly.

Important Note on Stub Adjustment When a stub is used to match a line to an impedance of the same order of impedance as that of the surge impedance of the stub and line (assuming the stub and line use the same wire size and spacing), it will be found that attaching the feeders to the stub introduces a large amount of reactance. The length of the stub then, must be altered considerably to restore resonance.

Unfortunately, alteration of the stub length requires that the position of attachment of the feeders be readjusted. Consequently, the adjustment entails considerable juggling of both stub length and point of feeder attachment, in order to minimize both reactance and standing waves.

Frequency in Kilocycles	Quarter-wave matching section or stub	Half-wave radiator
3500	70'3"	133'7"
3600	68'5"	129'10"
3700	67'6"	126'4"
3800	64'10"	123'
3900	63'1"	119'10"
3950	62'3"	118'4"
4000	61'6"	116'10"
7000	35'1"	66'9"
7150	34'5"	65'4"
7300	33'8"	64'
14,000	17'7"	33'5"
14,200	17'4"	32'11"
14,400	17'1"	32'6"
28,000	8'9"	16'8"
28,500	8'7"	16'5"
29,000	8'6"	16'1"
29,500	8'4"	15'10"

DIMENSIONS FOR HALF-WAVE RADIATOR AND QUARTER-WAVE MATCHING STUB OR Q SECTION.

If a *shorted* stub is used to feed an impedance of *more* than 3 times that of the surge impedance of the stub and line, this effect will be negligible, and it is not absolutely necessary that the stub length be readjusted after the feeders are attached. Likewise, the length of an *open* stub need not be altered after attachment of the feeders, if the stub feeds an impedance of *less* than 1/3 that of the surge impedance of the stub and line.

As a practical example, this means that if a 600-ohm line and shorted stub are used to feed an impedance of more than 1800 ohms, the length of the stub need not be readjusted after the feeders are attached (in order to eliminate objectionable reactance). If the stub feeds an impedance of less than 1800 ohms, attachment of the feeders to the stub will detune the stub appreciably, making readjustment of the stub length absolutely necessary.

When not sure of the exact order of impedance into which the stub works, it is always advisable to try "touching up" the stub length after the feeders are attached.

Two-Frequency Stub Matching It is practicable to use matching stubs to match an untuned line to an antenna or array on two frequencies. The frequencies need not be harmonically related if the antenna itself is capable of good efficiency on both frequencies. However, the frequencies should be in a ratio not exceeding 4/1 nor less than 1.3/1.

The arrangement is illustrated in Figure 19. The system is tuned up on the lowest frequency for minimum standing waves by means of adjusting the length and point of attachment of stub "A," stub "B" not yet being connected. After the standing waves are reduced to a negligible value, the transmitter is changed to the higher frequency. Stub "B," which is a quarter wave long on the *lower* frequency, then is attached experimentally, and the point of attachment varied until standing waves are at a minimum on the higher frequency. Because stub "B" is exactly a quarter wave long on the lower frequency, its attachment will have virtually no effect upon the operation of the antenna system at the lower frequency.

It should be kept in mind that stub "A" is tuned by varying the distances XY and AY; the stub does not "hang over" as does stub "B." The overall length of stub "B" is not altered; only the distances XZ and BZ are varied when adjusting for minimum standing waves on the higher frequency. It is possible that the position of the two stubs will be reversed from that shown in Figure 19. This depends upon the particular antenna being fed, and the characteristic impedance of the feed line.

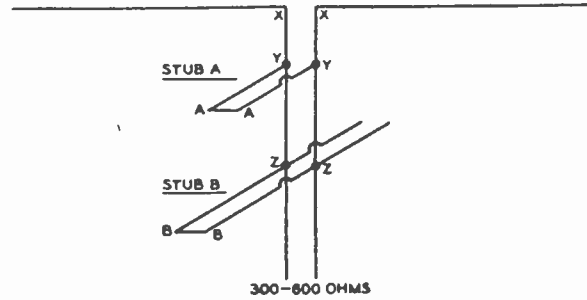

TWO-FREQUENCY STUB-MATCHED ANTENNA SYSTEM.

Any antenna which has a radiating system capable of efficient operation on two widely separated frequencies may be matched to an open wire transmission line on both frequencies by use of two "reactance stubs" as shown here. Operation and adjustment are explained in the text.

Standing Wave Indicators

Many simple devices can be used for detecting the presence and approximate ratio of standing waves on a feed line. A 1-turn pickup loop, about 4 or 5 inches in diameter, may be attached to a current indicator, such as a small Mazda bulb or an r-f thermogalvanometer, to indicate current excursions along the line. The device should be attached to the end of a wood stick at least a foot long in order to minimize body capacitance. The loop is moved along the line in inductive relation to the feed line, care being taken to see that the loop always is in *exactly the same inductive relation* to the line. It should be kept in mind that this type of indicator is a *current* indicator.

A small neon bulb also may be used to indicate standing waves on a feed line. In this case, the indicator works on *voltage*, and it should be kept in mind that the voltage on the line normally is highest where the current is lowest. This type of indicator is operated by touching various parts of the bulb to *one* feeder wire until an indication of medium brilliancy is obtained. The bulb is then slid along the wire, in *exactly the same position and point of contact with the wire*. If the enamel insulation is not intact on all portions of the wire and the wire is exposed in spots, deceptive "bumps" will be noticed. The wire should be either uniformly insulated or uniformly bare throughout its length; otherwise, it will be necessary to place a thickness of insulating material over the exposed metal parts of the neon bulb, the bulb then working by virtue of capacitance to the wire, rather than direct contact.

If it is desired to measure the exact rather than relative standing wave ratio and an r-f meter is not available, a low range d-c milliammeter may be used instead, if a suitable rectifier is placed in series with the d-c meter. A 0-1 ma. d-c milliammeter in series with a 1N34 crystal rectifier is commonly used. As noted before, this type of indicator is a *current* indicator.

If a considerable amount of antenna and feeder work is planned or in progress, a direct-reading standing-wave indicator such as is described in Chapter 31 may be constructed, or a manufactured instrument for making such measurements may be purchased.

12-14 Linear R. F. Transformers

A resonant quarter-wave line has the unusual property of acting much as a transformer. Let us take, for example, a section consisting of no. 12 wire spaced 6 inches, which happens to have a surge impedance of 600 ohms. Let the far end be terminated with a pure resistance, and let the near end be fed with radio-frequency energy at the frequency for which the line is a quarter wavelength long. If an impedance measuring set is used to measure the impedance at the near end while the

impedance at the far end is varied, an interesting relationship between the 600-ohm characteristic surge impedance of this particular quarter-wave matching line, and the impedance at the ends will be discovered.

When the impedance at the far end of the line is the same as the characteristic surge impedance of the line itself (600 ohms), the impedance measured at the near end of the quarter-wave line will also be found to be 600 ohms.

Under these conditions, the line would not have any standing waves on it, due to the fact that it is terminated in its characteristic impedance. Now, let the resistance at the far end of the line be doubled, or changed to 1200 ohms. The impedance measured at the near end of the line will be found to have been cut in half, to 300 ohms. If the resistance at the far end is made half the original value of 600 ohms or 300 ohms, the impedance at the near end doubles the original value of 600 ohms, and becomes 1200 ohms. As one resistance goes up, the other goes down proportionately.

It always will be found that the characteristic surge impedance of the quarter-wave matching line is the geometric mean between the impedance at both ends. This relationship is shown by the following formula:

$$Z_{MS} = \sqrt{Z_A Z_L}$$

where

Z_{MS} = Impedance of matching section.

Z_A = Antenna resistance.

Z_L = Line impedance.

Quarter-Wave Matching Transformers

The impedance inverting characteristic of a quarter-wave section of transmission line is widely used by making such a section of line act as a *quarter-wave transformer*. The "Johnson Q" feed system is a widely known application of the quarter-wave transformer to the feeding of a dipole antenna and array consisting of two dipoles. However, the quarter-wave transformer may be used in a wide number of applications wherever a transformer is required to match two impedances whose geometric mean is somewhere between perhaps 25 and 750 ohms when transmission line sections can be used. Paralleled coaxial lines may be used to obtain the lowest impedance mentioned, and open-wire lines composed of small conductors spaced a moderate distance may be used to obtain the higher impedance. A short list of impedances which may be matched by quarter-wave sections of transmission line having specified impedances is given below.

Load or Ant. Impedance	300	480	600	Feed-Line Impedance
20	77	98	110	Quarter-Wave Transformer Impedance
30	95	120	134	
50	110	139	155	
75	150	190	212	
100	173	220	245	

The impedance values from 20 to 50 ohms are obtained in the center of the driven element of a *wide-spaced* (0.2 wavelength or so) parasitic array or at the bottom of the stub of a "flat-top beam." 75 ohms represents the average center impedance of a half-wave doublet, and 100 ohms represents the approximate center impedance of one half wave of a full-wave antenna. Impedance values of 75 and 150 ohms can of course be obtained in Amphenol Twin-Lead, 100 and 200 ohms can be obtained, though less readily, in twinlead of other manufacture. Impedance values from 175 to 275 ohms can readily be obtained either from a four-wire line or from large-diameter dural or aluminum tubing spaced closely together ("Q Bars").

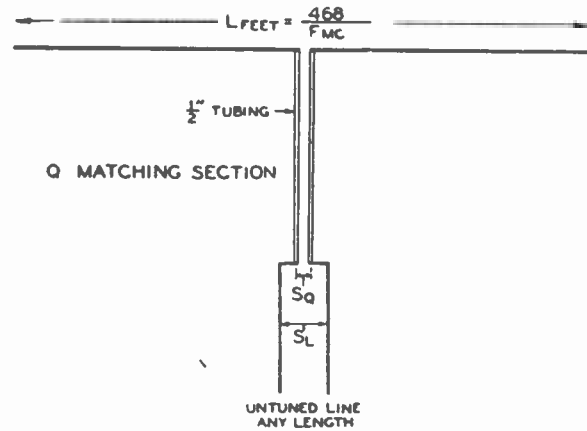

Figure 20.

HALF-WAVE RADIATOR FED BY "Q BARS".

The Q matching section is simply a quarter-wave transformer. The transformer may be made of parallel tubing, a four-wire line, or a section of twinlead of the 150-ohm type. The length of the section is equal to one-quarter wavelength at the operating frequency, multiplied by the factor V_r (relative velocity of propagation) of the particular type of quarter-wave matching transformer to be used.

Johnson-Q Feed System

The standard form of Johnson-Q feed to a doublet is shown in Figure 20. An impedance match is obtained by utilizing a matching section, the surge impedance of which is the geometric mean between the transmission line surge impedance and the radiation resistance of the radiator. A sufficiently good match usually can be obtained by either designing or adjusting the matching section for a dipole to have a surge impedance that is the geometric mean between the line impedance and 72 ohms, the latter being the theoretical radiation resistance of a half-wave doublet either infinitely high or a half wave above a perfect ground.

Though the radiation resistance may depart somewhat from 72 ohms under actual conditions, satisfactory results will be obtained with this assumed value, so long as the dipole radiator is more than a quarter wave above effective earth, and reasonably in the clear. The small degree of standing waves introduced by a slight mismatch will not increase the line losses appreciably, and any *small* amount of reactance present can be tuned out at the transmitter termination with no bad effects. If the reactance is objectionable, it may be minimized by making the untuned line an integral number of quarter waves long.

A Q-matched system can be adjusted precisely, if desired, by constructing a matching section to the calculated dimensions with provision for varying the spacing of the Q section conductors slightly, after the untuned line has been checked for standing waves.

The Q section usually will require about 200 ohms surge impedance when used to match a half-wave doublet, actually varying from about 150 to 250 ohms with different installations. This impedance is difficult to obtain with a two-wire line, as very close spacing would be required. For this reason, either a four-wire line or a line consisting of two half-inch

PARALLEL TUBING SURGE IMPEDANCE FOR MATCHING SECTIONS.

Center to Center Spacing in Inches	Impedance in Ohms for 1/2" Diameters	Impedance in Ohms for 1/4" Diameters
1	170	250
1.25	188	277
1.5	207	298
1.75	225	318
2	248	335

aluminum tubes is ordinarily used. The four-wire section has the advantage of lightness and cheapness, and can be used where the approximate radiation resistance is known with certainty, thus making it possible to design the matching section for a certain value of surge impedance with some assurance that it will turn out to be sufficiently accurate.

The apparent complexity of the Q-matched dipole comes from the large number of antennas and line combinations which the Q section is able to match.

The untuned transmission line between the transmitter and the input, or lower end of the Q section, can be any length (within reason).

12-15 Receiving Antennas

A receiving antenna should feed as much signal and as little noise—both man-made and atmospheric—to the receiver as possible. Placing the antenna as high as possible and away from house wiring, etc., will provide *physical* discrimination if a transmission line is used which has no signal pickup. Using a *resonant* antenna will provide *frequency* discrimination, attenuating signals and noise on frequencies removed from the resonant frequency of the antenna. Using a directional antenna will provide *directional* discrimination, attenuating signals and noise reaching the antenna from directions removed from that of the station transmitting the desired signal.

The ideal antenna has these 3 kinds of discrimination: physical, frequency, and directional, which will thus deliver the most signal and the least amount of noise to the input circuit of the receiver. Such an antenna connected to a mediocre receiver will give better results than will the best receiver made, working on a mediocre antenna.

All of the transmitting antennas previously described are suitable for receiving. A good transmitting antenna meets all three of the desirable requirements set forth above. For this reason, an amateur is seldom justified in erecting a separate antenna system for the purpose of receiving. A d-p-d-t relay designed for r-f use, working off the send-receive switch or the communications switch on the receiver, can be used to throw whatever transmitting antenna is being used at the time to the receiver input terminals.

Fortunately, the antenna that delivers the best signal into a certain locality will also be best for receiving from that locality, and, conversely, the antenna which provides the best received signal will be best for transmitting to the same locality. In fact, a rotary antenna can be aimed at a station for maximum gain when transmitting by the simple expedient of rotating the array for maximum received signal.

As most man-made noise is essentially vertically polarized, an antenna or array with horizontal polarization will give minimum noise pickup from that source. For this reason, an array with horizontal polarization is advisable when it is to be used not only for transmission but also for reception.

The problem of noise pickup is most important because it is the signal-to-noise ratio that limits the signals capable of being received satisfactorily. No amount of receiver amplification will make a signal readable if the noise reaching the receiver is as loud as the signal. Peak-limiting devices will improve reception when trouble is experienced from *short-pulse* popping noises, such as auto ignition interference. But no electrical device in the receiver is of avail against the steady buzzing, frying noises present in most urban districts.

For the latter type of interference, caused by power leaks, defective neon signs, etc., a recently developed modification of an old principle is oftentimes of considerable help. A noise antenna, a short piece of wire placed so as to pick up as much of the interfering noise and as little of the desired signal as possible, is fed to the input of the receiver *out of phase* with the energy received from the main antenna. By proper adjust-

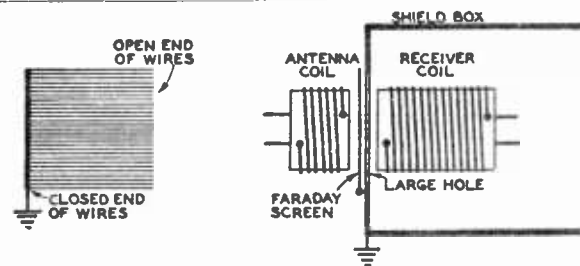

Figure 21.
FARADAY ELECTROSTATIC SHIELD.

ment of coupling and experimentation with the length and placement of the noise antenna, it is sometimes possible to eliminate the offending noise completely. The system of noise bucking is described in Chapter 5 under *Noise Suppression*.

Stray Pickup More care has to be taken in coupling a transmission line to a receiver than to a transmitter. The whole antenna system, antenna and transmission line, may tend to act as a Marconi antenna to ground, by virtue of capacity coupling. When transmitting, this effect merely lowers the maximum discrimination of a directive array with but little effect on the power gain; with a nondirectional antenna, nothing will even be noticed when there is a very slight amount of Marconi effect. But if the effect is present when *receiving*, there is little point in using an antenna removed as far as possible from noise sources, because the transmission line itself will pick up the noise.

Faraday Electrostatic Shield There are two simple ways of avoiding the Marconi effect. The first method calls for a grounded *Faraday screen* between the antenna coil of the receiver and the input grid circuit. This eliminates all capacity coupling. This type of electrostatic shield can be constructed by winding a large number of turns of very small insulated wire on a piece of cardboard which has first been treated with insulating varnish. The wire is wound on, then another coating of varnish is applied.

After it has dried, *one edge* is trimmed with tin snips or heavy shears, and the wires are soldered together along the opposite edge. The screen is placed between the two coils and grounded. If properly made, it has little effect on the inductive coupling, as there are no closed loops.

Balancing Coils The second method calls for a center-tapped antenna coil with the center tap grounded. If the coil is not easily accessible, a small center-tapped coil of from 5 to 30 turns is connected across the antenna input to the receiver, and the center tap grounded. While not critical, the best number of turns depends upon the type of transmission line, the frequency, and the turns on the antenna coil in the receiver. For this reason, the correct number of turns can best be determined by experiment.

The center tap must be at the *exact* electrical center of the coil. The coil may be scramble wound, and made self-supporting by means of adhesive tape. It should be borne in mind that a twisted-pair or open two-wire line will work *correctly* only if the receiver has provision for balanced (doublet) input. This is especially true of the latter type of line. If one side of the input or antenna coil is grounded inside the receiver, the ground connection must be broken and moved to the center of the coil, or an external balancing coil may be used.

Impedance Matching Another thing to take into consideration is the impedance of the input circuit of the receiver. If the receiver has high impedance input, it will not give maximum performance when a twisted-pair line is

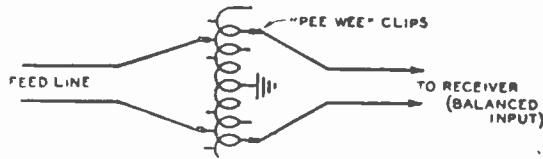

Figure 22.

"AUTOTRANSFORMER" IMPEDANCE-MATCHING COIL.

The match between a two-wire line and any receiver input can often be improved by means of a coupling autotransformer as shown. The best points to tap can be determined by experiment. The antenna transmission line clips should always be tapped the same number of turns each side of center. When the receiver has a balanced input the secondary turns should also be tapped the same number of turns each side of center. When the receiver has an unbalanced input or a coaxial input one lead to the receiver should be connected to the grounded center of the coil and the other lead tapped up and down until the best point is found.

Oftentimes a further improvement can be obtained, as discussed in the text, by tuning the coil with a small variable capacitor and coupling the antenna transmission line and the receiver input to the tuned circuit by means of separate links.

used. If it has low impedance input, it will not give maximum performance with an open-wire line. Most receivers are designed with 200- to 300-ohm (medium impedance) input, and will work well with either type line. However, the performance can sometimes be improved by incorporating an impedance matching transformer, even when the receiver has medium impedance (300 ohms) input.

Such a transformer is illustrated in Figure 22. If the line is of lower impedance than the receiver input, the line should be tapped across the fewer number of turns to provide the desired impedance step up. If the line is of higher impedance, the converse applies. Often the coupler will work better if a variable condenser is placed across the entire coil to tune it to resonance.

If the line impedance is lower than that of the receiver, the receiver should be tapped across more turns than the line. If the line impedance is higher than that of the receiver input, the converse applies.

Under certain conditions improved results over those obtainable with the circuit of Figure 22 can be had by tuning the coupling coil. With the tuned arrangement separate links are placed around the tuned circuit for the antenna transmission line and the leads to the receiver. The capacitor which tunes the coil can usually be tuned for the center of the band and left at that adjustment for the entire band. Variation in the number of turns on the antenna link and on the link which goes to the receiver will make it possible to obtain an optimum match between the antenna transmission line and the input circuit of the receiver. This circuit arrangement is particularly useful when the receiver has a very low input impedance.

12-16

Loop Antennas

As a radiation field contains a magnetic component, it is readily apparent that a coil of wire placed in the proper inductive relation to the magnetic component will serve as an antenna. The efficacy as a pickup antenna is low, as compared to a regular receiving antenna, but because of its compactness and directional characteristics, the loop often is used as a portable antenna, or as a direction indicator.

The loop may be in the form of a circle, square, or rectangle whose length and width are not too widely different. It may be wound in the form of a solenoid, or in the form of a "pancake" helix. For true loop operation, however, the circumference of the loop should not be more than a small fraction of a wavelength.

The loop may be either resonant or non-resonant, though there will be considerable increase in signal pickup when the loop is resonant to the frequency of the signal being received. Also, the directional pattern is different for the two loops, except when both are perfectly balanced to ground, and there is no stray receiver pickup. If there is stray pickup, or the loop is not perfectly balanced, an asymmetrical pattern results *except when the loop is tuned to exact resonance*. With a resonant loop, the only effect of circuit unbalance to ground is to result in the absence of complete nulls; instead, there will be found *minima* as the loop is rotated, the minima being 180 degrees apart, same as nulls in a perfectly balanced system.

The result of circuit unbalance to ground, or of stray pickup in the input coupling circuit, permits the whole loop to work against ground as a Marconi antenna. The current thus induced combines with the true loop current. If the loop is resonant, the phasing of the two currents is such as to maintain a symmetrical pattern, but there no longer will be complete nulls. If the loop is not resonant, the phasing of the two currents is such as to add in certain directions and cancel in others, resulting in an asymmetrical pattern.

Figure 23 shows the patterns obtained under these various conditions. Pattern A is obtained when there is no Marconi effect (also variously known as "antenna effect" or "vertical effect") with either a resonant or nonresonant loop.

With a nonresonant loop, a moderate amount of Marconi effect will produce the pattern shown at B. If the amount of Marconi effect is increased, a point finally will be reached where the small lobe completely disappears, leaving only one null. This pattern is shown at C.

A moderate amount of Marconi effect produces the pattern shown at D, when the loop is resonant. When the loop is tuned just slightly off exact resonance, a pattern intermediate between B and D is obtained.

For some applications, the entire loop is enclosed in a static shield. For aircraft work, this shield greatly reduces "rain static." It also virtually eliminates Marconi effect, which is important in the circuits used in aircraft direction indicators.

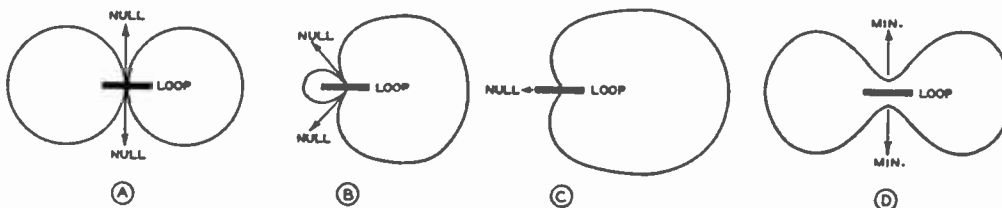

Figure 23.

TYPICAL LOOP ANTENNA PATTERNS.

- A: Loop antenna, either resonant or nonresonant, perfectly balanced to ground (no antenna effect).
- B: Nonresonant loop antenna, moderate antenna effect.
- C: Nonresonant loop antenna, critical amount of antenna effect. Minor lobe completely disappears, leaving only one null.
- D: Resonant loop antenna, moderate antenna effect. Nulls are changed to minima, but remain separated exactly 180 degrees.

Workshop Practice

WITH a few possible exceptions, such as fixed air capacitors, neutralizing capacitors and transmitting coils, it hardly pays one to attempt to build the components required for the construction of an amateur transmitter. This is especially true when the parts are of the type used in construction and replacement work on broadcast receivers, as mass production has made these parts very inexpensive.

Transmitters Those who have and wish to spend the necessary time can effect considerable monetary saving in their transmitters by building them from the component parts. The necessary data are given in the construction chapters of this handbook.

To many builders, the construction is as fascinating as the operation of the finished transmitter; in fact, many amateurs get so much satisfaction out of building a well-performing piece of equipment that they spend more time constructing and rebuilding equipment than they do operating the equipment on the air.

Those who are not mechanically minded and are more interested in the pleasures of working dx and rag chewing than in experimentation and construction will find on the market many excellent transmitters which require only line voltage and an antenna. If you are one of those amateurs, you will find little to interest you in this chapter.

Receivers There is room for argument as to whether one can save money by constructing his own communications receiver. The combined demand for these receivers by the government, amateurs, airways, short-wave listeners, and others has become so great that it may be argued that there is no more point in building such a receiver than in building a regular broadcast set. Yet, many amateurs still prefer to construct their own receivers—in spite of the fact that it costs almost as much to build a receiver as to purchase an equivalent factory-made job—either because they enjoy construction work and take pride in the fruits of their efforts, or because the receiver must meet certain specifications and yet cost as little as possible.

The only factory-produced receiver that is sure to meet the requirements of every amateur or short-wave listener is the rather expensive de luxe type having every possible refinement.

An amateur of limited means who is interested only in c.w. operation on two or three bands, for instance, can build himself, at a fraction of the cost of a de luxe job, a receiver that will serve his particular purpose just as well. In the receiver construction chapter are illustrated several relatively inexpensive receivers which, for the particular purpose for which they were designed, will perform as well as the costliest factory-built receiver.

13-1 Types of Construction

Layout and mounting of the component parts usually requires the most time and work. Various methods of mounting can be used, ranging from simple wooden boards to elaborate metal racks and panels.

Breadboard The simplest method of constructing equipment is to lay it out in breadboard fashion, which consists of fastening the various components to a board of suitable size with wood screws or machine bolts, arranging the parts so that important leads will be as short as possible.

While this type of construction is also adaptable to receivers and measuring and monitoring equipment, it is used principally for transmitter construction, and remains a favorite of the c.w. amateurs using high power.

Breadboard construction requires a minimum of tools; apparatus can be constructed in this fashion with the aid of only a rule, screwdriver, ice pick, saw, and soldering iron. A hand drill will also be required if it is desired to run part of the wiring underneath the breadboard, or if bolts are used to fasten down the parts. Ordinary carpenter's tools will be quite satisfactory.

Danger from accidental electrical shock usually is greatest with this type construction because of the exposed components.

An improved type of breadboard construction consists of "battens" approximately $1\frac{3}{4}$ inch wide by $\frac{3}{8}$ inch thick built up in the form of a metal chassis but with the two battens comprising the top separated enough to mount wafer type sockets with the terminals projecting down through the opening.

Metal Chassis Though quite a few more tools and considerably more time will be required for its construction, much neater equipment can be built by mounting

the parts on sheet metal chassis instead of breadboards. This type of construction is advisable when shielding of the apparatus is necessary, as breadboard construction does not particularly lend itself to shielding. The appearance of the apparatus may be further enhanced by incorporating a front panel upon which the various controls are placed. A front panel minimizes the danger of shock.

If sufficient pains are taken with the construction, and a front panel is used in conjunction with either a dust cover (cabinet) or enclosed relay rack, the apparatus can be made to resemble or even to rival factory-built equipment in appearance.

Dish type construction is practically the same as metal chassis construction, the main difference lying in the manner in which the chassis is fastened to the panel.

Special Frameworks For high-powered r.f. stages, many amateur constructors prefer to discard the more conventional types of construction and employ instead special metal frameworks and brackets which they design specially for the parts which they intend to use. These are usually arranged to give the shortest possible r.f. leads and to fasten directly behind a relay rack panel by means of a few bolts, with the control shafts projecting through corresponding holes in the panel.

13-2

Tools

Beautiful work can be done with metal chassis and panels with the help of only a few inexpensive tools. However, the time required for construction will be greatly reduced if a fairly complete assortment of metal-working tools is available. Thus, it can be seen that while an array of tools will speed up the work, excellent results may be accomplished with but few tools, if one has the time and patience.

The investment one is justified in making in tools is dependent upon several factors. If you like to tinker, there are many tools useful in radio construction that you would probably buy anyway, or perhaps already have, such as screwdrivers, hammer, saws, square, vise, files, etc. This means that the money taken for tools from your radio budget can be used to buy the more specialized tools, such as socket punches or hole saws, taps and dies, etc.

The amount of construction work one does determines whether buying a large assortment of tools is an economical move. It also determines if one should buy the less expensive type offered at surprisingly low prices by the familiar mail order houses, "five and ten" stores and chain auto-supply stores, or whether one should spend more money and get first-grade tools. The latter cost considerably more and work but little better when new, but will outlast several sets of the cheaper tools. Therefore they are a wise investment for the experimenter who does lots of construction work (if he can afford the initial cash outlay). The amateur who constructs only an occasional piece of apparatus need not be so concerned with tool life, as even the cheaper grade tools will last him several years, if they are given proper care.

The hand tools and materials in the accompanying lists will be found very useful around the home workshop. Materials not listed but ordinarily used, such as paint, can best be purchased as required for each individual job.

ESSENTIAL HAND TOOLS AND MATERIALS

- 1 Good electric soldering iron, about 100 watts
- 1 Spool rosin-core wire solder
- 1 Each large, medium, small, and midget screwdrivers
- 1 Good hand drill (eggbeater type), preferably two speed
- 1 Pair regular pliers, 6 inch

- 1 Pair long nose pliers, 6 inch
- 1 Pair cutting pliers (diagonals), 5 inch or 6 inch
- 1 1½-inch tube-socket punch
- 1 "Boy Scout" knife
- 1 Combination square and steel rule, 1 foot
- 1 Yardstick or steel pushrule
- 1 Scratch awl or ice pick scribe
- 1 Center punch
- 1 Dozen or more assorted round shank drills (as many as you can afford between no. 50 and ¼ or ⅜ inch, depending upon size of hand drill chuck)
- 1 Combination oil stone
- Light machine oil (in squirt can)
- Friction tape
- 1 Hacksaw and blades
- 1 Medium file and handle
- 1 Cold chisel (½ inch tip)
- 1 Wrench for socket punch
- 1 Hammer

HIGHLY DESIRABLE HAND TOOLS AND MATERIALS

- 1 Bench vise (jaws at least 3 inch)
- 1 Spool plain wire solder
- 1 Carpenter's brace, ratchet type
- 1 Square-shank countersink bit
- 1 Square-shank taper reamer, small
- 1 Square-shank taper reamer, large (The two reamers should overlap; ½ inch and ⅞ inch size will usually be suitable.)
- 1 ⅞ inch tube-socket punch (for electrolytic capacitors)
- 1 1-3/16 inch tube-socket punch
- 1 1½ inch tube-socket punch
- 1 Adjustable circle cutter for holes to 3 inch
- 1 Set small, inexpensive, open-end wrenches
- 1 Pair tin shears, 10 or 12 inch
- 1 Wood chisel (½ inch tip)
- 1 Pair wing dividers
- 1 Coarse mill file, flat, 12 inch
- 1 Coarse bastard file, round, ½ or ¾ inch diameter
- 6 or 8 Assorted small files: round, half-round, triangular, flat, square, rat-tail
- 4 Small "C" clamps
- Steel wool, coarse and fine
- Sandpaper and emery cloth, coarse, medium, and fine
- Duco cement
- File brush

USEFUL BUT NOT ESSENTIAL TOOLS AND MATERIALS

- 1 Jig or scroll saw (small) with metal-cutting blades
- 1 Small wood saw (crosscut teeth)
- 1 Each square-shank drills: ⅜, 7/16, and ½ inch
- 1 Tap and die outfit for 6-32, 8-32, 10-32 and 10-24 machine screw threads
- 4 Medium size "C" clamps
- Lard oil (in squirt can)
- Kerosene
- Empire cloth
- Clear lacquer ("industrial" grade)
- Lacquer thinner
- Dusting brush
- Paint brushes
- Sheet celluloid, Lucite, or polystyrene
- 1 Carpenter's plane
- 1 Each "Spintite" wrenches, ¼, 5/16, 11/32 to fit the standard 6-32 and 8-32 nuts used in radio work
- 1 Screwdriver for recessed head type screws

The foregoing assortment assumes that the constructor does not want to invest in the more expensive power tools, such as drill press, grinding head, etc. If power equipment is purchased, obviously some of the hand tools and accessories listed will be superfluous. A drill press greatly facilitates construction work, and it is unfortunate that a good one costs as much as a small transmitter. A booklet* available from the Delta Manufacturing Co. will be of considerable aid to those who have access to a drill press.

Not listed in the table are several special-purpose radio tools which are somewhat of a luxury, but are nevertheless quite handy, such as various around-the-corner screwdrivers and wrenches, special soldering iron tips, etc. These can be found in the larger radio parts stores and are usually listed in their mail order catalogs. It is not uncommon to find amateurs who have had sufficient experience as machinists to design and produce tools for special purposes.

If it is contemplated to use the newer and very popular miniature series of tubes (6AK5, 6C4, 6BA6, etc.) in the construction of equipment certain additional tools will be required to mount the smaller components. In the first place the sockets for the miniature series of tubes require a 3/8-inch hole. A Greenlee socket punch may be obtained in this size or a smaller hole may be reamed out to the proper size. Needless to say, the punch is much the more satisfactory solution. Mounting screws for miniature sockets are usually of the 4-40 size.

13-3 Construction Practice

Chassis Layout The chassis first should be covered with a layer of wrapping paper, which is drawn tightly down on all sides and fastened with scotch tape. This allows any number of measurement lines and hole centers to be spotted in the correct positions without making any marks on the chassis itself. Place on it the parts to be mounted and play a game of chess with them, trying different arrangements until all the grid and plate leads are made as short as possible, tubes are clear of coil fields, r.f. chokes are in safe positions, etc. Remember, especially if you are going to use a panel, that a good mechanical layout often can accompany sound electrical design, but that the electrical design should be given first consideration.

All too often parts are grouped to give a symmetrical panel, irrespective of the arrangement behind. When a satisfactory arrangement has been reached, the mounting holes may be marked. The same procedure now must be followed for the underside, always being careful to see that there are no clashes between the two (that no top mounting screws come down into the middle of a paper capacitor on the underside, that the variable condenser rotors do not hit anything when turned, etc.).

When all the holes have been spotted, they should be center-punched *through* the paper into the chassis. Don't forget to spot holes for leads which must also come through the chassis.

For transformers which have lugs on the bottoms, the clearance holes may be spotted by pressing the transformer on a piece of paper to obtain impressions, which may then be transferred to the chassis.

Punching In cutting socket holes, one can use either a fly-cutter or socket punches. These punches are easy to operate and only a few precautions are necessary. The guide pin should fit snugly in the guide hole. This increases the accuracy of location of the socket. If this is not of great importance, one may well use a drill of 1/32 inch larger diameter than the guide pin. Some of the punches will operate without guide holes, but the latter always make the punching

NUMBERED DRILL SIZES

DRILL NUMBER	Di- ameter (in.)	Clears Screw	Correct for Tapping Steel or Brass†
1.....	.228	—	—
2.....	.221	12-24	—
3.....	.213	—	14-24
4.....	.209	12-20	—
5.....	.205	—	—
6.....	.204	—	—
7.....	.201	—	—
8.....	.199	—	—
9.....	.196	—	—
10*.....	.193	10-32	—
11.....	.191	10-24	—
12*.....	.189	—	—
13.....	.185	—	—
14.....	.182	—	—
15.....	.180	—	—
16.....	.177	—	12-24
17.....	.173	—	—
18*.....	.169	8-32	—
19.....	.166	—	12-20
20.....	.161	—	—
21*.....	.159	—	10-32
22.....	.157	—	—
23.....	.154	—	—
24.....	.152	—	—
25*.....	.149	—	10-24
26.....	.147	—	—
27.....	.144	—	—
28*.....	.140	6-32	—
29*.....	.136	—	8-32
30.....	.128	—	—
31.....	.120	—	—
32.....	.116	—	—
33*.....	.113	4-36 4-40	—
34.....	.111	—	—
35*.....	.110	—	6-32
36.....	.106	—	—
37.....	.104	—	—
38.....	.102	—	—
39*.....	.100	3-48	—
40.....	.098	—	—
41.....	.096	—	—
42*.....	.093	—	4-36 4-40
43.....	.089	2-56	—
44.....	.086	—	—
45*.....	.082	—	3-48

†Use next size larger drill for tapping bakelite and similar composition materials (plastics, etc.).

*Sizes most commonly used in radio construction.

operations simpler and easier. The only other precaution is to be sure the work is properly lined up before applying the hammer. If this is not done, the punch may slide sideways when you strike and thus not only shear the chassis but also take off part of the die. This is easily avoided by always making sure that the piece is parallel to the faces of the punch, the die, and the base. The latter should be an anvil or other solid base of heavy material.

A punch by *Greenlee* forces socket holes through the chassis by means of a screw turned with a wrench. It is noiseless, and works much more easily and accurately than most others.

The male part of the punch should be placed in the vise, cutting edge up and the female portion forced against the metal with a wrench as in Figure 1. These punches can be obtained in sizes to accommodate all tube sockets and even large enough to be used for meter holes. In the tube socket sizes they require the use of a 3/8 inch center hole to accommodate the bolt.

Transformer Cutouts Cutouts for transformers and chokes are not so simply handled. After marking off the part to be cut, drill about a 1/4-inch hole on each of the inside corners and tangential to the edges. After burring

* "Getting the Most Out of Your Drill Press." James Tate, Delta Manufacturing Company, Milwaukee, Wisconsin.

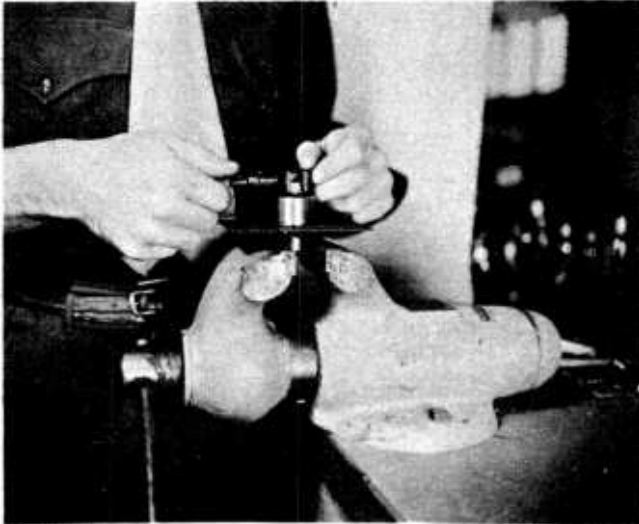

Figure 1.
PROPER METHOD OF USING A SOCKET PUNCH
OF THE "GREENLEE" TYPE.

the holes, clamp the piece and a block of cast iron or steel in the vise. Then, take your burring chisel and insert it in one of the corner holes. Cut out the metal by hitting the chisel with a hammer. The blows should be light and numerous. The chisel acts against the block in the same way that the two blades of a pair of scissors work against each other. This same process is repeated for the other sides. A file is used to trim up the completed cutout.

Another method is to drill the four corner holes large enough to take a hack saw blade, then saw instead of chisel. The four holes permit nice looking corners.

Still another method is shown in Figure 2. When heavy panel steel is used and a drill press or electric drill is available, this is the most satisfactory method.

Removing Burrs In both drilling and punching, a burr is usually left on the work. There are three simple ways of removing these. Perhaps the best is to take a chisel (be sure it is one for use on metal) and set it so that its bottom face is parallel to the piece. Then gently tap it with a hammer. This usually will make a clean job with a little practice. If one has access to a counterbore, this will also do a nice job. A countersink will work, although it bevels the edges. A drill of several sizes larger is a much used arrangement. The third method is by filing off the burr, which does a good job but scratches the adjacent metal surfaces badly.

Mounting Components There are two methods in general use for the fastening of transformers, chokes, and similar pieces of apparatus to chassis or breadboards.

The first, using nuts and machine screws, is slow, and the commercial manufacturing practice of using self-tapping screws is gaining favor. For the mounting of small parts such as resistors and capacitors, "tie strips" are very useful to gain rigidity. They also contribute materially to the appearance of finished apparatus.

Rubber grommets of the proper size, placed in all chassis holes through which wires are to be passed, will give a neater appearing job and also will reduce the possibility of short circuits.

Soldering Making a strong, low-resistance solder joint does not mean just dropping a blob of solder on the two parts to be joined and then hoping that they'll stick. There are several definite rules that *must* be observed.

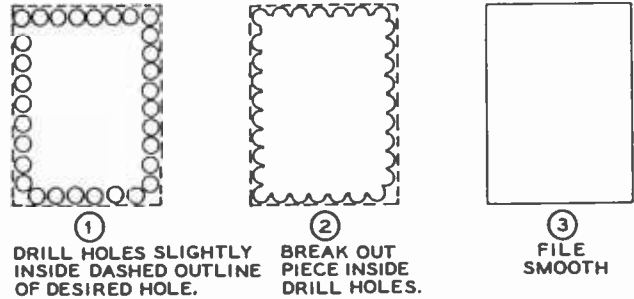

①
DRILL HOLES SLIGHTLY
INSIDE DASHED OUTLINE
OF DESIRED HOLE.

②
BREAK OUT
PIECE INSIDE
DRILL HOLES.

③
FILE
SMOOTH

MAKING RECTANGULAR CUTOUT

Figure 2.

All parts to be soldered must be absolutely clean. To clean a wire, lug, or whatever it may be, take your pocket knife and scrape it thoroughly, until fresh metal is laid bare. It is not enough to make a few streaks; scrape until the part to be soldered is bright.

Make a good mechanical joint before applying any solder. Solder is intended primarily to make a good electrical connection; mechanical rigidity should be obtained by bending the wire into a small hook at the end and nipping it firmly around the other part, so that it will hold well even before the solder is applied.

Keep your iron properly tinned. It is impossible to get the work hot enough to take the solder properly if the iron is dirty. To tin your iron, file it, while hot, on one side until a full surface of clean metal is exposed. Immediately apply rosin core solder until a thin layer flows completely over the exposed surface. Repeat for the other faces. Then take a clean rag and wipe off all excess solder and rosin. The iron should also be wiped frequently while the actual construction is going on; it helps prevent pitting the tip.

Apply the solder to the work, not to the iron. The iron should be held against the parts to be joined until they are thoroughly heated. The solder should then be applied against the parts, and the iron should be held in place until the solder flows smoothly and envelops the work. If it acts like water on a greasy plate, and forms a ball, the work is not sufficiently clean.

The completed joint must be held perfectly still until the solder has had time to solidify. If the work is moved before the solder has become completely solid, a "cold" joint will result. This can be identified immediately, because the solder will have a dull "white" appearance rather than one of shiny "silver." Such joints tend to be of high resistance, and will very likely have a bad effect upon a circuit. The cure is simple: merely reheat the joint and do the job correctly.

Wipe away all surplus flux when the joint has cooled if you are using a paste type flux. Be sure it is non-corrosive, and use it with plain (not rosin core) solder.

Finishes If the apparatus is constructed on a painted chassis (commonly available in black wrinkle and gray wrinkle), there is no need for application of a protective coating when the equipment is finished, assuming that you are careful not to scratch or mar the finish while drilling holes and mounting parts. However, many amateurs prefer to use unpainted (zinc or cadmium plated) chassis, because it is much simpler to make a chassis ground connection with this type of chassis. A thin coat of clear "linoleum" lacquer may be applied to the whole chassis after the wiring is completed to retard rusting. In localities near the sea coast it is a good idea to lacquer the various chassis cutouts even on a painted chassis, as rust will get a good start at these points unless the metal

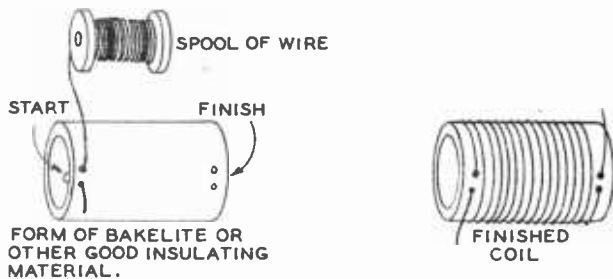

WINDING COIL ON INSULATING FORM

Figure 3.

is protected where the drill or saw has exposed it. If too thick a coat is applied, the lacquer will tend to peel. It may be thinned with lacquer thinner to permit application of a light coat. A thin coat will adhere to any *clean* metal surface that is not too shiny.

An attractive dull gloss finish, almost velvety, can be put on aluminum by sand-blasting it with a very weak blast and fine particles and then lacquering it. Soaking the aluminum in a solution of lye produces somewhat the same effect as a fine grain sand blast.

There are also several brands of dull gloss black enamels on the market which adhere well to metals and make a nice appearance. Air-drying wrinkle finishes are sometimes successful, but a baked job is usually far better. Wrinkle finishes, properly applied, are very durable and are pleasing to the eye. If you live in a large community, there is probably an enameling concern which can wrinkle your work for you at a reasonable cost. A very attractive finish, for panels especially, is to spray a wrinkle finish with aluminum paint. In any painting operation (or plating, either, for that matter), the work should be very thoroughly cleaned of all greases and oils.

To protect brass from tarnish, thoroughly cleanse and remove the last trace of grease by the use of potash and water. The brass must be carefully rinsed with water and dried; but in doing it, care must be taken not to handle any portion with the bare hands or anything else that is greasy. Then lacquer.

Drilling Glass This is done with a common drill by using a mixture of turpentine and camphor. When the point of the drill has come through, it should be taken out and the hole worked through with the point of a three-cornered file, having the edges ground sharp. Use the corners of the file, scraping the glass rather than using the file as a reamer. Great care must be taken not to crack the glass or flake off parts of it in finishing the hole after the point of the drill has come through. Use the mixture freely during the drilling and scraping. The above mixture will also be found useful in drilling hard cast iron. Drilling glass must be done very slowly. It is a good idea to practice by drilling several holes in scrap glass before tackling the actual piece to be drilled, to acquire the knack.

Etching Solution Add three parts nitric acid to one part muriatic acid. Cover the piece to be etched with beeswax. This can be done by heating the piece in a gas or alcohol flame and rubbing the wax over the surface. Use a sharp steel point or hard lead pencil point as a stylus. A pointed glass dropper can be used to put the solution at the place needed. After the solution foams for two or three minutes, remove with blotting paper and put oil on the piece, and then heat and remove the wax.

Chromium Polish So much chromium is now used in radio sets and on panels that it is well to know that this finish may be polished. The only materials required

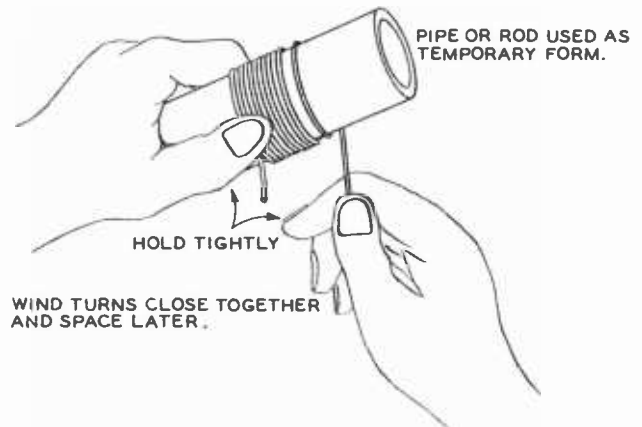

WINDING "AIR-SUPPORTED" COIL

Figure 4.

are absorbent cotton or soft cloth, alcohol, and ordinary lampblack.

A wad of cotton or the cloth is moistened in the alcohol and pressed into the lampblack. The chromium is then polished by rubbing the lampblack adhering to the cotton briskly over its surface. The mixture dries almost instantly and may be wiped off with another wad of cotton.

The alcohol serves merely to moisten the lampblack to a paste and make it stick to the cotton. The mixture cleans and polishes very quickly and cannot scratch the chromium surface. It polishes nickel-work just as effectively as it does chromium. Care should be taken to see that the lampblack does not contain any hard, gritty particles which might produce scratches during the polishing.

Winding Coils Coils are of two general types, those using a form and "air-wound" types. Neither type offers any particular constructional difficulties. Figure 3 illustrates the procedure used in form winding a coil. If the winding is to be spaced, the spacing can be done either by eye or a string or another piece of wire may be wound simultaneously with the coil wire and removed after the winding is in place. The usual procedure is to clamp one end of the wire in a vise, attaching the other end to the coil form and with the coil form in hand, walk slowly towards the vise winding the wire but at the same time keeping a strong tension on the wire as the form is rotated. After the coil is wound, if there is any possibility of the turns slipping, the completed coil is either entirely coated with a coil or Duco cement or cemented in those spots where slippage might occur.

V-h-f and u-h-f coils are commonly wound of heavy enameled wire on a form and then removed from the form as in Figure 4. If the coil is long or has a tendency to buckle, strips of polystyrene or a similar material may be cemented longitudinally inside the coil. Due allowance must be made for the coil springing out when removed from the form, when selecting the diameter of the form.

On air wound coils of this type, spacing between turns is accomplished after removal from the form, by running a pencil, the shank of a screwdriver or other round object spirally between the turns from one end of the coil to the other, again making due allowance for spring.

Air-wound coils approaching the appearance of commercially manufactured ones, can be constructed by using a round wooden form which has been sawed diagonally from end to end. Strips of insulating material are temporarily attached to this mandrel, the wire then being wound over these strips with the desired separation between turns and cemented to the strips. When dry, the split mandrel may be removed by un-wedging it.

Broadcast Interference

RADIO signals which intrude upon a broadcast program constitute a nuisance to which disturbed listeners are bound to object vigorously.

Broadcast interference is a matter of grave importance to all amateurs. Indeed, an amateur station license is placed in considerable jeopardy by repeated citations of interference with broadcast or other commercial stations. The FCC regulations are particularly severe in this respect, and they require that the offending amateur correct the trouble or keep off the air during specified hours of the day or night.

In general, signals from a transmitter operating properly are not picked up by receivers tuned to other frequencies unless the receiver is of inferior design, or is in poor condition. Therefore, if the receiver is of good design and is in good repair, the burden of rectifying the trouble rests with the owner of the interfering station.

Phone and c.w. stations both are capable of causing broadcast interference, key-click annoyance from code transmitters being particularly objectionable. The elimination of key clicks is fully covered in Chapter 7 under *Keying*.

A knowledge of each of the several types of broadcast interference, their cause, and methods of eliminating them is necessary to the successful disposition of this trouble. An effective method of combatting one variety of interference is often of no value whatever in the correction of another type. Broadcast interference seldom can be cured by "rule of thumb" procedure.

Broadcast interference, as covered in this chapter, refers to standard (amplitude modulated, 550-1600 kc.) broadcast. Interference to frequency modulated broadcast is highly unlikely except when there is an FM receiver in close proximity to a transmitter afflicted with h.f. parasitics or radiating strong harmonics.

The use of frequency-modulation transmission by an amateur station is likely to result in much less interference to broadcast reception than either amplitude-modulated telephony or straight keyed c.w. This is true because, insofar as the broadcast receiver is concerned, the amateur FM transmission will consist of a plain unmodulated carrier. There will be no key clicks or voice reception picked up by the b.c.l. set (unless it happens to be an FM receiver which might pick up a harmonic of the signal), although there might be a slight click when the transmitter is put on or taken off the air. This is one

reason why narrow-band FM has become so popular with phone enthusiasts who have experienced difficulties with the local b.c.l.'s.

14-1 Interference Classifications

Depending upon whether it is traceable directly to causes within the *station* or within the *receiver*, broadcast interference may be divided into two main classes. For example, that type of interference due to transmitter over-modulation is at once listed as being caused by improper operation, while an interfering signal that tunes in and out with a broadcast station is probably an indication of cross-talk in the receiver, and the poorly-designed input stage of the receiver is held liable. The various types of interference and recommended cures will be discussed separately.

Blanketing This is not a tunable effect, but a total blocking of the receiver. A more or less complete "wash-out" covers the entire receiver range when the carrier is switched on. This produces either a complete blotting out of all broadcast stations, or else knocks down their volume several decibels—depending upon the severity of the interference. Voice modulation of the carrier causing the blanketing will be highly distorted or even unintelligible. Keying of the carrier which produces the blanketing will cause an annoying fluctuation in the volume of the broadcast signals.

Blanketing generally occurs in the immediate neighborhood (inductive field) of a powerful transmitter, the affected area being directly proportional to the power of the transmitter. This type of interference occurs most frequently where the receiver uses an outside antenna which happens to resonate at a frequency close to that of the offending transmitter. Also it is more prevalent with transmitters which operate in the 80-meter band, than with those on the higher frequencies.

The remedies are to (1) shorten the receiving antenna and thereby shift its resonant frequency, or (2) remove it to the interior of the building, (3) change the direction of either the receiving or transmitting antenna to minimize their mutual coupling, or (4) keep the interfering signal from entering the receiver input circuit by installing a wave-trap tuned to the signal frequency (see Figure 1).

A suitable wave-trap is quite simple in construction, consist-

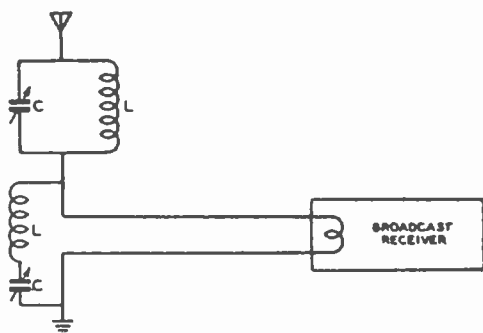

Figure 1.

EFFECTIVE WAVE TRAP CIRCUIT FOR HIGH ATTENUATION OF INTERFERING SIGNAL REACHING RECEIVER VIA ANTENNA.

This type of trap works at full efficiency over but a small range in frequency, and therefore is not effective when several interfering signals of widely different frequencies are present. When only moderate attenuation is required, a single tank (either series or shunt) will often suffice. For coil and capacitor values refer to Figure 3.

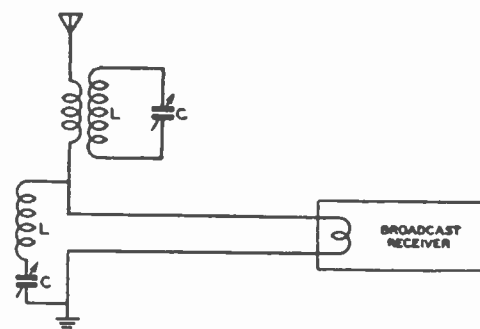

Figure 2.

MODIFICATION OF CIRCUIT SHOWN IN FIGURE 1.

In this case, the parallel resonant tank is coupled to the antenna with 3 to 6 turns of wire instead of being placed in series with the antenna lead. It gives slightly better performance than the circuit of Figure 1 with certain antennas.

ing only of a coil and midget variable capacitor. When the trap circuit is tuned to the frequency of the interfering signal, little of the interfering voltage reaches the grid of the first tube.

The circuit shown in Figure 1 is particularly effective because it consists of two traps. The shunt trap blocks or rejects the frequency to which it is tuned while the series trap across the antenna and ground terminals of the receiver, provides a very low impedance path to ground at the frequency to which it is tuned and by-passes the signal to ground. In moderate interference cases, either the shunt or series trap may be used alone, while similarly, one trap may be tuned to one of the frequencies of the interfering transmitter and the other trap to a different interfering frequency. In either case, each trap is effective over but a small frequency range and must be re-adjusted for other frequencies.

The wave-trap must be installed as close to the receiver antenna terminal as practicable, hence it should be as small in size as possible. The variable capacitor may be a midget air-tuned trimmer type, and the coil may be wound on a 1-inch dia. form. The table of Figure 3 gives winding data for wave-traps built around a 50- μ fd. variable capacitor. For best results, both a shunt and a series trap should be employed as shown.

Figure 2 shows a two-circuit coupled wave-trap that is somewhat sharper in tuning and more efficacious. The specifications for the secondary coil L may be obtained from the table in Figure 3. The primary coil of the shunt trap consists of 3 to 5 closewound turns of the same size wire wound in the same direction on the same form as L and separated from the latter by $\frac{1}{8}$ of an inch.

Overmodulation A carrier modulated in excess of 100 per cent acquires sharp cutoff periods (Figure 1) which give rise to transients. These transients create a broad signal and often generate spurious frequencies at odd places on the dial. Transients caused by overmodulation of a radiotelephone signal may at the same time bring about impact or shock excitation of nearby receiving antenna and power lines, transmitting interfering voltages in that manner.

Broadcast interference due to overmodulation is generally common to 75-meter operation. The remedy is to reduce the modulation percentage or to use a clipper-filter system in the speech circuit of the transmitter. Clipper-filter circuits are described in detail in Chapter 7 and are illustrated in Chapter 24.

Cross Modulation Cross modulation or "cross talk" is characterized by the amateur signal "riding in" on top of strong local broadcasts. There is usually no heterodyne note, the amateur signal being tuned in and out with the program carriers.

This effect is due entirely to a faulty input stage in the affected receiver. Modulation of the interfering carrier will swing the operating point of the input tube. This type of trouble is seldom experienced when a variable- μ tube is used in the input stage.

Where the receiver is too ancient to incorporate such a tube, and is probably poorly shielded at the same time, it will be better to attach a wave-trap of the type shown in Figure 1 than to attempt rebuilding of the receiver. The addition of a good ground and a shield can over the input tube often adds to the effectiveness of the wave-trap.

Transmission via Capacitance Coupling A small amount of capacitance coupling is now widely used in receiver r.f. and detector transformers as a gain booster at the high-frequency end of the tuning range. The coupling capacitance is obtained by means of a small loop of wire cemented close to the grid end of the secondary winding, and with one end directly connected to the plate or antenna end of the primary winding (see Figure 5).

From the relations of capacitive reactance, it is easily seen that a small capacitor will favor the higher frequencies, and it is evident that capacitance coupling in the receiver coils will tend to pass amateur short-wave signals into a receiver tuned to broadcast frequencies.

Figure 3. R. F. WAVE TRAP COIL AND CAPACITOR TABLE.

BAND	COIL L	CAPACITOR C
80	41 turns no. 28 enameled close-wound 1-inch form	50- μ fd. variable
40	21 turns no. 24 enameled 11/16-inch long 1-inch form	50- μ fd. variable
20	7 turns no. 24 enameled 5/16-inch long 1-inch form	50- μ fd. variable
10	4 turns no. 24 enameled 5/16-inch long 1-inch form	50- μ fd. variable

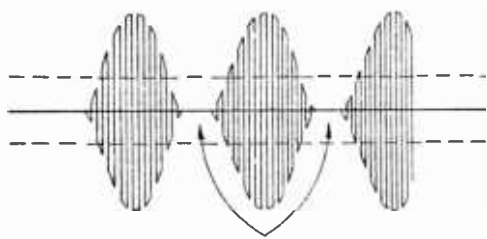

PRODUCES SAME EFFECT
AS RAPID KEY CLICKS

Figure 4.

ILLUSTRATING HIGH DAMPING CHARACTERISTIC OF BADLY OVER-MODULATED SIGNAL.

The resulting interference seldom can be cured by wave traps or line filters; it must be corrected at the transmitter.

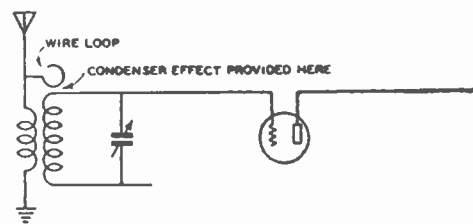

Figure 5.

TYPICAL AUXILIARY CAPACITANCE COUPLING CIRCUIT USED IN B. C. SETS TO BOOST GAIN AT 1500 KC. END OF BAND.

Even though the coupling capacitance may be small, it will have a fairly low reactance at high frequencies, and will aggravate interference from amateur stations, particularly those working on 14 and 28 Mc.

The amount of capacitance coupling may be reduced to eliminate interference by moving the coupling turn further away from the secondary coil. However, a simple wave-trap of the type shown in Figures 1 and 2, inserted at the antenna input terminal, will generally accomplish the same result and is more to be recommended than changing the capacitance coupling (which lowers the receiver gain at the high frequency end of the broadcast band). Should the wave-trap alone not suffice, it will be necessary to resort to a reduction in the coupling capacitance.

In some simple broadcast receivers, capacitance coupling is unintentionally obtained by too closely coupled primary and secondary coils, or as a result of running a long primary or antenna lead close to the secondary coil of an unshielded antenna coupler.

Phantoms When two strong local carriers are separated by a certain number of kilocycles, the beat note resulting between them may fall on some frequency within the broadcast band and, if rectified by any means, be audible at that point. If such a "phantom" signal falls on a local broadcast frequency, there will be heterodyne interference as well. This is a common occurrence with broadcast receivers in the neighborhood of two amateur stations, or an amateur and a police station. It also sometimes occurs when only one of the stations is located in the immediate vicinity.

As an example: an amateur signal on 3514 kc. might beat with a local 2414-kc. police carrier to produce a 1100-kc. phantom. If the two carriers are strong enough in the vicinity of a circuit which can cause rectification, the 1100-kc. phantom will be heard in the broadcast band. A poor contact between two oxidized wires can produce rectification.

Two stations must be transmitting simultaneously to produce a phantom signal; when either station goes off the air the phantom disappears. Hence, this type of interference is apt to be reported as highly intermittent and might be difficult to duplicate unless a test oscillator is used "on location" to simulate the missing station. Such interference cannot be remedied at the transmitter, and often the rectification takes place some distance from the receivers. In such occurrences it is most difficult to locate the source of the trouble.

It will also be apparent that a phantom might fall on the intermediate frequency of a simple superhet receiver and cause interference of the untunable variety if the manufacturer has not provided an i-f wave-trap in the antenna circuit.

This particular type of phantom may, in addition to causing i-f interference, generate harmonics which may be tuned in and out with heterodyne whistles from one end of the receiver dial to the other. It is in this manner that "birdies" often result from the operation of nearby amateur stations.

When one component of a phantom is a steady, unmodulated carrier, only the intelligence present on the other carrier is conveyed to the broadcast receiver.

Phantom signals almost always may be identified by the suddenness with which they are interrupted, signaling withdrawal of one party to the union. This is especially baffling to the inexperienced interference-locator, who observes that the interference suddenly disappears, even though its own transmitter remains in operation.

If the mixing or rectification is taking place in the receiver itself, a phantom signal may be eliminated by removing either one of the contributing signals from the receiver input circuit. A wave-trap of the types shown in Figures 1 and 2, tuned to either signal, will do the trick. If the rectification is taking place outside the receiver, the wave-trap should be tuned to the frequency of the phantom, instead of to one of its components. I-f wavetraps may be built around a 2.5-millihenry r-f choke as the inductor, and a compression-type mica padding capacitor. The capacitor should have a capacitance range of 250—525 $\mu\text{fd.}$ for the 175- and 206-kc. intermediate frequencies; 65—175 $\mu\text{fd.}$ for 260 kc. and other intermediates lying between 250 and 400 kc.; and 17—80 $\mu\text{fd.}$ for 456, 465, 495, and 500 kc. Slightly more capacitance will be required for resonance with a 2.1 millihenry choke.

Spurious Emissions This sort of interference arises from the transmitter itself. The radiation of any signal (other than the intended carrier frequency) by an amateur station is prohibited by FCC regulations. Spurious radiation may be traced to imperfect neutralization, parasitic oscillations in the r-f or modulator stages, or to "broadcast-band" variable-frequency oscillations or e.c.o.'s.

Low-frequency parasitics may actually occur on broadcast frequencies or their near sub-harmonics, causing direct interference to programs. An all-wave monitor operated in the vicinity of the transmitter will detect these spurious signals.

The remedy will be obvious in individual cases. Elsewhere in this book are discussed methods of complete neutralization and the suppression of parasitic oscillations in r-f and audio stages.

Stray Receiver Rectification A receiver in the immediate neighborhood of a strong transmitter is subject to stray rectification within the receiver. It is due to the interfering signal being rectified by the second detector in a superhet (detector in a tuned r-f set), or an audio stage of the receiver if poorly shielded or containing too long a grid lead.

This type of interference is most commonly caused by ultra-high-frequency transmitters, doubtless because at those fre-

BAND	COIL L	CAPACITOR C
80	17 turns no. 14 enameled 3-inch diameter 2 1/4-inch length	100-μfd. variable
40	11 turns no. 14 enameled 2 1/2-inch diameter 1 1/2-inch length	100-μfd. variable
20	4 turns no. 10 enameled 3-inch diameter 1 1/8-inch length	100-μfd. variable
10	3 turns 1/4-inch o.d. copper tubing 2-inch diameter 1-inch length	100-μfd. variable

Figure 6. POWERLINE WAVE TRAP COIL AND CAPACITOR TABLE.

quencies lengthy connections in the receiver can easily become fractions of the transmitter wavelength. The interfering signal is not tunable, and generally covers the entire dial.

If the receiver is not a series-filament set, the trouble may be localized by removing the tubes, starting with the input stage and working toward the audio output stage. The interfering signal will cease when the tube rectifying it is removed from its socket.

Signal rectification in an audio stage may be cured by connecting a 2.5-millihenry pi-wound r-f choke in series with the control-grid lead and input terminal and a .0001-μfd. capacitor from grid to ground. But the task is not so simple when rectification occurs in one of the other stages. Here, complete shielding of the set, tubes, and exposed r-f leads (such as top-cap grid leads) will have to be provided. In addition, it may be necessary to lower the bias of the offending stage.

"Floating" Volume Control Shafts Several sets have been encountered where there was only a slightly interfering signal; but, upon placing one's hand up to the volume control, the signal would greatly increase. Investigation revealed that the volume control was installed with its shaft insulated from ground. The control itself was connected to a critical part of a circuit, in many instances to the grid of a high-gain audio stage. The cure is to install a volume control with *all* the terminals insulated from the shaft, and then to ground the shaft.

Spray-Shield Tubes Although they are no longer made, there are yet quite a few sets in use which employ spray-shield tubes. These are used in both r-f and in audio circuits. In some audio applications of this type of tube, the cathode and the spray-shield (to which the cathode is connected) are not at ground potential, but are bypassed to ground with an electrolytic capacitor of large capacitance. This type of capacitor is a very poor r-f filter and, in a strong r-f field, some detection will take place, producing interference. The best cure is to install a standard glass tube with a glove shield, which is then actually grounded, and also to shield the grid leads to these tubes. As an alternative, bypassing the electrolytic cathode capacitor with a .05-μfd. tubular paper capacitor may be tried.

Power-Line Pickup When radio-frequency energy from a radio transmitter enters a broadcast receiver through the a-c power lines, it has either been fed back into the lighting system by the offending transmitter, or picked up from the air by overhead power lines. Underground lines are seldom responsible for spreading this interference.

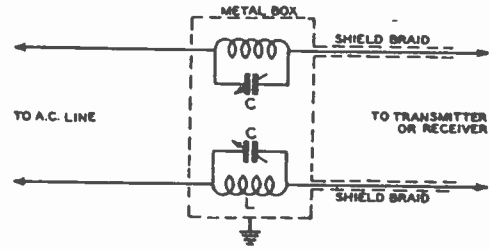

Figure 7.

METHOD OF CONNECTING POWER LINE WAVE TRAP.

A parallel resonant circuit is more effective than an r-f choke in keeping r.f. from getting from a transmitter into the power line, or from the power line into a receiver. A .05-μfd. tubular capacitor connected from each 110-volt wire to ground often will increase the effectiveness of the traps. They may be connected on either side of the line traps.

To check the path whereby the interfering signals reach the lines, it is only necessary to replace the transmitting antenna with a dummy antenna and adjust the transmitter for maximum output. If the interference then ceases, overhead lines have been picking up the energy. The trouble can be cleared up only by installing wave-traps in the power lines at the receiver. These are then tuned to the interfering signal frequency. If the receiver is reasonably close to the transmitter, it is very doubtful that changing the direction of the transmitting antenna to right angles with the overhead lines will eliminate the trouble.

If, on the contrary, the interference continues when the transmitter is connected to the dummy antenna, radio-frequency energy is being fed directly into the power line by the transmitter, and the station must be inspected to determine the cause.

One of the following reasons for the trouble will usually be found: (1) the r-f stages are not sufficiently bypassed and/or choked, (2) the antenna coupling system is not performing efficiently, (3) the power transformers have no electrostatic shields; or, if shields are present, they are ungrounded, (4) power lines are running too close to an antenna or r-f circuits carrying high currents. If none of these causes apply, wave-traps must be installed in the power lines at the transmitter to remove r-f energy passing back into the lighting system.

The wave-traps used in the power lines at transmitter or receiver must be capable of passing relatively high amperage. The coils are accordingly wound with heavy wire. Figure 6 lists the specifications for power line wave-trap coils, while Figure 7 illustrates the method of connecting these wave-traps. Observe that these traps are enclosed in a shield box of heavy iron or steel, well grounded.

All-Wave Receivers Each complete-coverage home receiver is a potential source of annoyance to the transmitting amateur. The novice short-wave broadcast-listener who tunes in an amateur station often considers it an interfering signal, and complains accordingly.

Neither selectivity nor image reactivity in most of these sets is in any wise comparable to those properties in a communication receiver. The result is that an amateur signal will occupy too much dial space and appear at more than one point, giving rise to interference on adjacent channels and removed channels as well.

If carrier-frequency harmonics are present in the amateur transmission, serious interference will result at the all-wave receiver. The harmonics will, if the carrier frequency has been

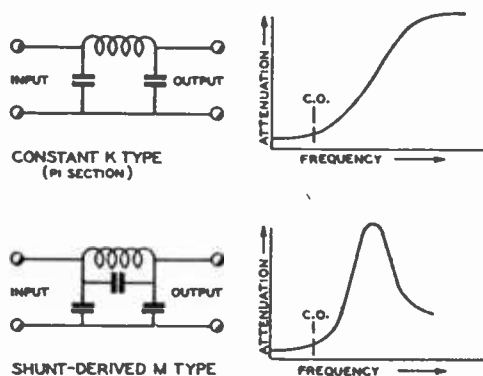

Figure 8.

TWO TYPES OF LOW PASS FILTERS AND THE KIND OF ATTENUATION CURVE OBTAINED WITH EACH.
 The M-derived type has sharper cut-off but not as great attenuation at frequencies two or more octaves above the cut-off frequency.

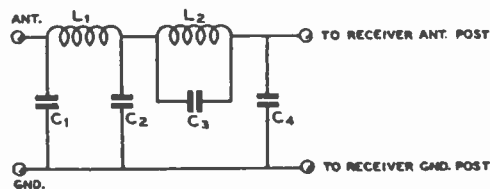

Figure 9.

COMPOSITE LOW PASS FILTER POSSESSING ADVANTAGES OF BOTH K SECTION AND M DERIVED FILTER.
 This filter is highly effective in reducing broadcast interference from all high frequency stations, and requires no tuning. Constants for 400-ohm terminal impedance and 1900 kc. cutoff are as follows: L₁, 65 turns no. 22 d.c.c. close wound on 1/2 in. dia. form. L₂, 41 turns ditto, not coupled to L₁. C₁, 250 μfd. fixed mica, C₂, 400 μfd. fixed mica. C₃ and C₄, 150 μfd. fixed mica, former of 5% tolerance. With some receivers, better results will be obtained with a 200-ohm carbon resistor inserted between the filter and antenna post on the receiver. With other receivers the effectiveness will be improved with a 600-ohm carbon resistor placed on the antenna post to the ground post on the receiver. The filter should be placed as close to the receiver terminals as possible.

so unfortunately chosen, fall directly upon a favorite short-wave broadcast station and arouse warranted objection.

The amateur is apt to be blamed, too, for transmissions for which he is not responsible, so great is the public ignorance of short-wave allocations and signals. Owners of all-wave receivers have been quick to ascribe to amateur stations all signals they hear from tape machines and V-wheels, as well as stray tones and heterodyne flutters they hear.

The amateur cannot be held responsible when his carrier is deliberately tuned in on an all-wave receiver. Neither is he accountable for the width of his signal on the receiver dial, or for the strength of image repeat points, if it can be proven that the receiver design does not afford good selectivity and image rejection.

If he so desires, the amateur (or the owner of the receiver) might sharpen up the received signal somewhat by shortening the receiving antenna. Set retailers often supply quite a sizable antenna with all-wave receivers, but most of the time these sets perform almost as well with a few feet of inside antenna.

The amateur is accountable for harmonics of his carrier frequency. Such emissions are unlawful in the first place, and he must take all steps necessary to their suppression. Practical suggestions for the elimination of harmonics will be found elsewhere in this book (see *Index*).

14-2 Superheterodyne Interference

In addition to those types of interference already discussed, there are two more which are common to superhet receivers. The prevalence of these types is of great concern to the amateur, although the responsibility for their existence more properly rests with the broadcast receiver.

While at the time of writing, the 160-meter band probably will not be restored to amateur use, it affords an example of direct image-frequency interference.

The mechanism whereby image production takes place may be explained in the following manner: when the first detector is set to the frequency of an incoming signal, the high-frequency oscillator is operating on another frequency which differs from the signal by the number of kilocycles in the intermediate frequency. Now, with the setting of these two stages undisturbed, there is another signal which will beat with the high-frequency oscillator to produce an i.f. voltage. This other signal is the so-called image, which is separated from the desired signal by twice the intermediate frequency.

Thus, in a receiver with 175-kc. i.f., tuned to 1000 kc.: the h.f. oscillator is operating on 1175 kc., and a signal on 1350

kc. (1000 kc. plus 2 × 175 kc.) will beat with this 1175 kc. oscillator frequency to produce the 175-kc. i.f. signal. Similarly, when the same receiver is tuned to 1400 kc., an amateur signal on 1750 kc. can come through. The dial point where any 160-meter signal will produce an image can be determined from the equation:

$$F_b = (F_{am} - 2 \text{ i.f.})$$

Where F_b = receiver dial frequency
 F_{am} = amateur transmitter frequency, and
 i.f. = receiver intermediate frequency.

If the image appears only a few cycles or kilocycles from a broadcast carrier, heterodyne interference will be present as well. Otherwise, it will be tuned in and out in the manner of a station operating in the broadcast band. Sharpness of tuning will be comparable to that of broadcast stations producing the same a.v.c. voltage at the receiver.

The second variety of superhet interference is the result of harmonics of the receiver h.f. oscillator beating with amateur carriers to produce the intermediate frequency of the receiver. The amateur transmitter will always be found to be on a frequency equal to some harmonic of the receiver h.f. oscillator, plus or minus the intermediate frequency.

As an example: when a broadcast superhet with 465-kc. i.f. is tuned to 1000 kc., its high-frequency oscillator operates on 1465 kc. The third harmonic of this oscillator frequency is 4395 kc., which will beat with an amateur signal on 3950 kc. to send a signal through the i.f. amplifier. The 3950 kc. signal would be tuned in at the 1000-kc. point on the dial.

Some oscillator harmonics are so related to amateur frequencies that more than one point of interference will occur on the receiver dial. Thus, a 3500-kc. signal may be tuned in at six points on the dial of a nearby broadcast superhet having 175 kc. i.f. and no r-f stage.

Insofar as remedies for image and harmonic superhet interference are concerned, it is well to remember that if the amateur signal did not in the first place reach the input stage of the receiver, the annoyance would not have been created. It is therefore good policy to try to eliminate it by means of a wave-trap. Broadcast superhets are not always the acme of good shielding, however, and the amateur signal is apt to enter the circuit through channels other than the input circuit. If a wave-trap or filter will not cure the trouble, the only alternative will be to attempt to select a transmitter frequency such that neither image nor harmonic interference will be set up on

favorite stations in the susceptible receivers. The equation given earlier may be used to determine the proper frequencies.

Low Pass Filters The greatest drawback of the wave-trap is the fact that it is a single-frequency device; i.e.—it may be set to reject at one time only one frequency (or, at best, an extremely narrow band of frequencies). Each time the frequency of the interfering transmitter is changed, every wave-trap tuned to it must be returned.

A much more satisfactory device is the *wave filter* which requires no tending. One type, the low pass filter, passes all frequencies below one critical frequency, and eliminates all higher frequencies. It is this property that makes the device ideal for the task of removing amateur frequencies from broadcast receivers.

A good low pass filter designed for maximum attenuation around 1900 kc. will pass all broadcast carriers, but will reject

signals originating in any amateur band. Naturally such a device should be installed only in standard broadcast receivers, never in all-wave sets.

Two types of low pass filters are shown in Figure 8. A composite arrangement comprising a section of each type is more effective than either type operating alone. A composite filter composed of one K-section and one shunt-derived M-section is shown in Figure 9, and is highly recommended. The M-section is designed to have maximum attenuation at 1900 kc., and for that reason C_2 should be of the "close tolerance" variety. Likewise, C_2 should not be stuffed down inside L_2 in the interest of compactness, as this will alter the inductance of the coil appreciably, and likewise the resonant frequency.

If a fixed 150 μfd . mica capacitor of 5 per cent tolerance is not available for C_2 , a compression trimmer covering the range of 125—175 μfd . may be substituted and adjusted to give maximum attenuation at about 1900 kc.

Reference Data

RESISTOR-CAPACITOR COLOR CODE				
Color	Significant Figure	Decimal Multiplier	Tolerance Per cent	Voltage Rating (Capacitors Only)
Black	0	1	—	—
Brown	1	10	1	100
Red	2	100	2	200
Orange	3	1,000	3	300
Yellow	4	10,000	4	400
Green	5	100,000	5	500
Blue	6	1,000,000	6	600
Violet	7	10,000,000	7	700
Gray	8	100,000,000	8	800
White	9	1,000,000,000	9	900
Gold	—	0.1	5	1000
Silver	—	0.01	10	2000
No color	—	—	20	500

Resistor Color Code The values of resistance and tolerance for resistors are indicated most commonly by bands around the resistor, although for the older style of resistor with leads coming out radially the characteristics are indicated sometimes by dots and the body color. In the case of the conventional radial lead resistor the color starts from one end of the resistor, the first color denoting the first significant figure. The second color denotes the second significant figure and the third color denotes the decimal multiplier. The last colored band indicates the tolerance and will be gold or silver for a 5 per cent or 10 per cent tolerance resistor. In the case of radial lead resistors the body color denotes the

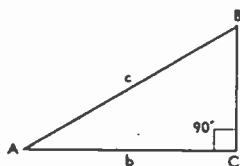

Figure 1.

In this figure the sides *a*, *b*, and *c* are used to define the trigonometric functions of angle *B* as well as angle *A*.

first significant figure, the end color denotes the second significant figure, and the band or dot in the center denotes the decimal multiplier. In the case of radial lead resistors the tolerance marking, if used, is a small band on the opposite end from the main color end.

Capacitor Color Code There are two basic methods for marking small mica and molded-paper capacitors. In the RMA 3-dot system the first dot reading in the direction of the arrow is the first significant figure, the second dot is the second significant figure, and the third dot is the decimal multiplier. This type of marking gives the capacitance in micromicrofarads; capacitors marked in such a manner have a 500-volt rating and a 20 per cent tolerance.

In the 6-dot system of marking capacitors the *top* row of dots has an indicating arrow for direction of reading. These three top dots indicate the first, second, and third significant figure of the capacitance. The bottom dot on the *right* then indicates the decimal multiplier for the three significant figures

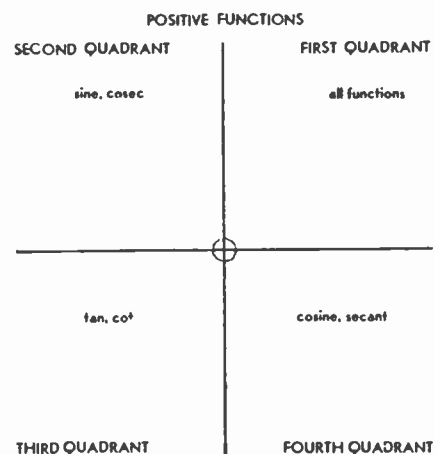

Figure 2.

SIGNS OF THE TRIGONOMETRIC FUNCTIONS.

The functions listed in this diagram are positive; all other functions are negative.

obtained from the top dots, giving the resulting capacitance in micromicrofarads. The center dot on the bottom gives the tolerance of the capacitor. The dot on the left of the bottom gives the voltage rating in the case of RMA marked capacitors, and gives the "characteristic" of the capacitor in the case of JAN or AWS marked capacitors.

Basic Trigonometry

Trigonometry is the mathematics of triangles. Trigonometry is commonly used both in the calculation of electrical circuits and in the determination of dimensions in the installation of antenna systems and their supporting poles. A few basic relationships will be given. These relationships, with the aid of a table of trigonometric functions, may be used in making simple calculations involving triangles.

Relations in Right Triangles

In the right triangle of Figure 1, $\sin A = a/c$ and by transposition

$$a = c \sin A$$

For the same reason we have the following identities:

$$\tan A = a/b$$

$$\cot A = b/a$$

$$a = b \tan A$$

$$b = a \cot A$$

In the same triangle we can do the same for functions of the angle B

$$\sin B = b/c$$

$$\cos B = a/c$$

$$\tan B = b/a$$

$$\cot B = a/b$$

$$b = c \sin B$$

$$a = c \cos B$$

$$b = a \tan B$$

$$a = b \cot B$$

Functions of Angles Greater than 90 Degrees

In angles greater than 90 degrees, the values of a and b become negative on occasion in accordance with the rules of Cartesian coordinates. When b is measured from 0 towards the left it is considered negative and similarly, when a is measured from 0 downwards, it is negative.

Summarizing, the sign of the functions in each quadrant can be seen at a glance from Figure 2, where in each quadrant are

written the names of functions which are positive; those not mentioned are negative.

Decibels

The decibel represents the ratio between two power levels, usually connected with gains or loss associated with an amplifier or other network. The decibel is defined:

$$N_{db} = 10 \log \frac{P_0}{P_1}$$

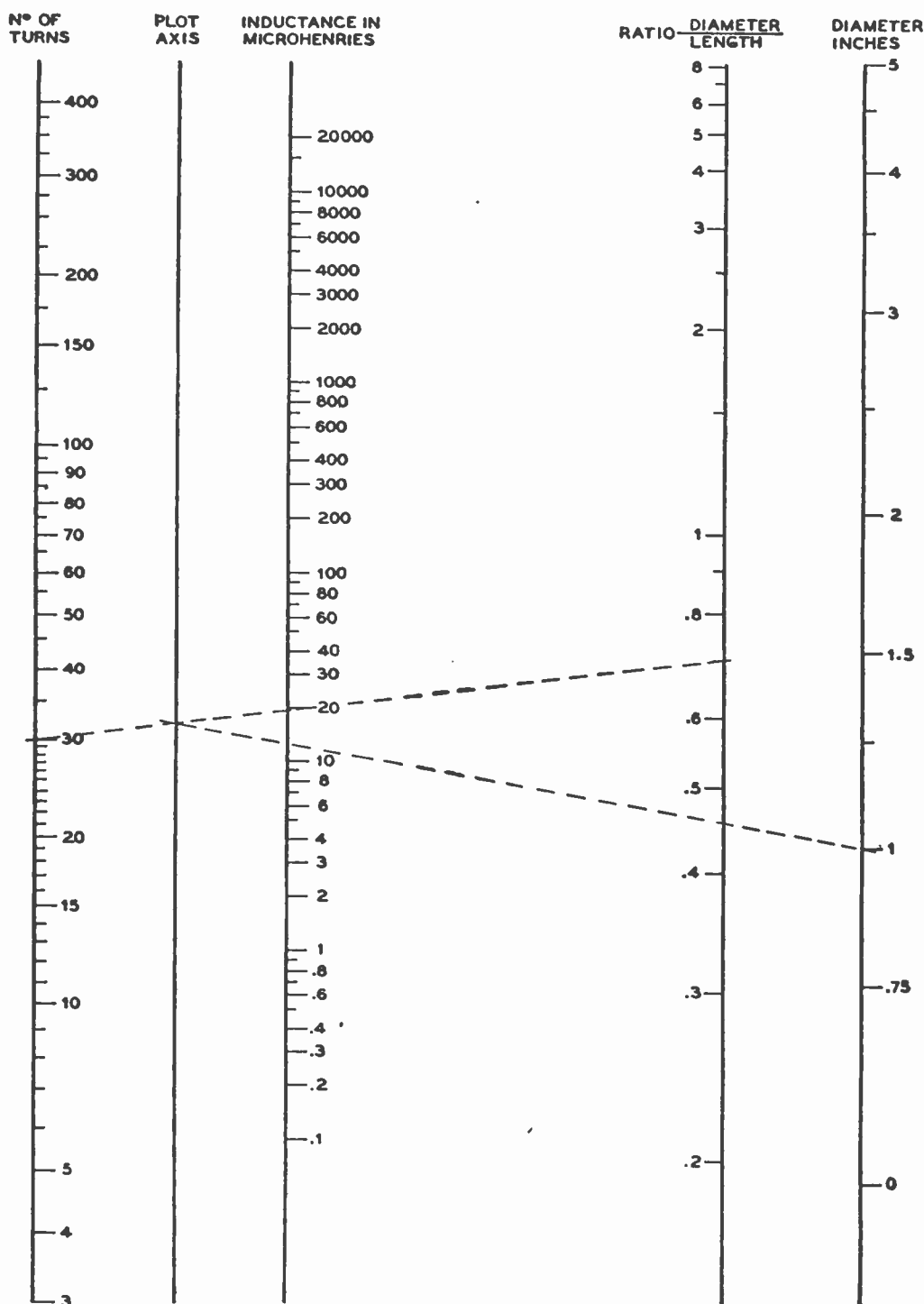

Figure 3.

COIL CALCULATOR NOMOGRAPH

For single layer solenoid coils, any wire size. See text for instructions.

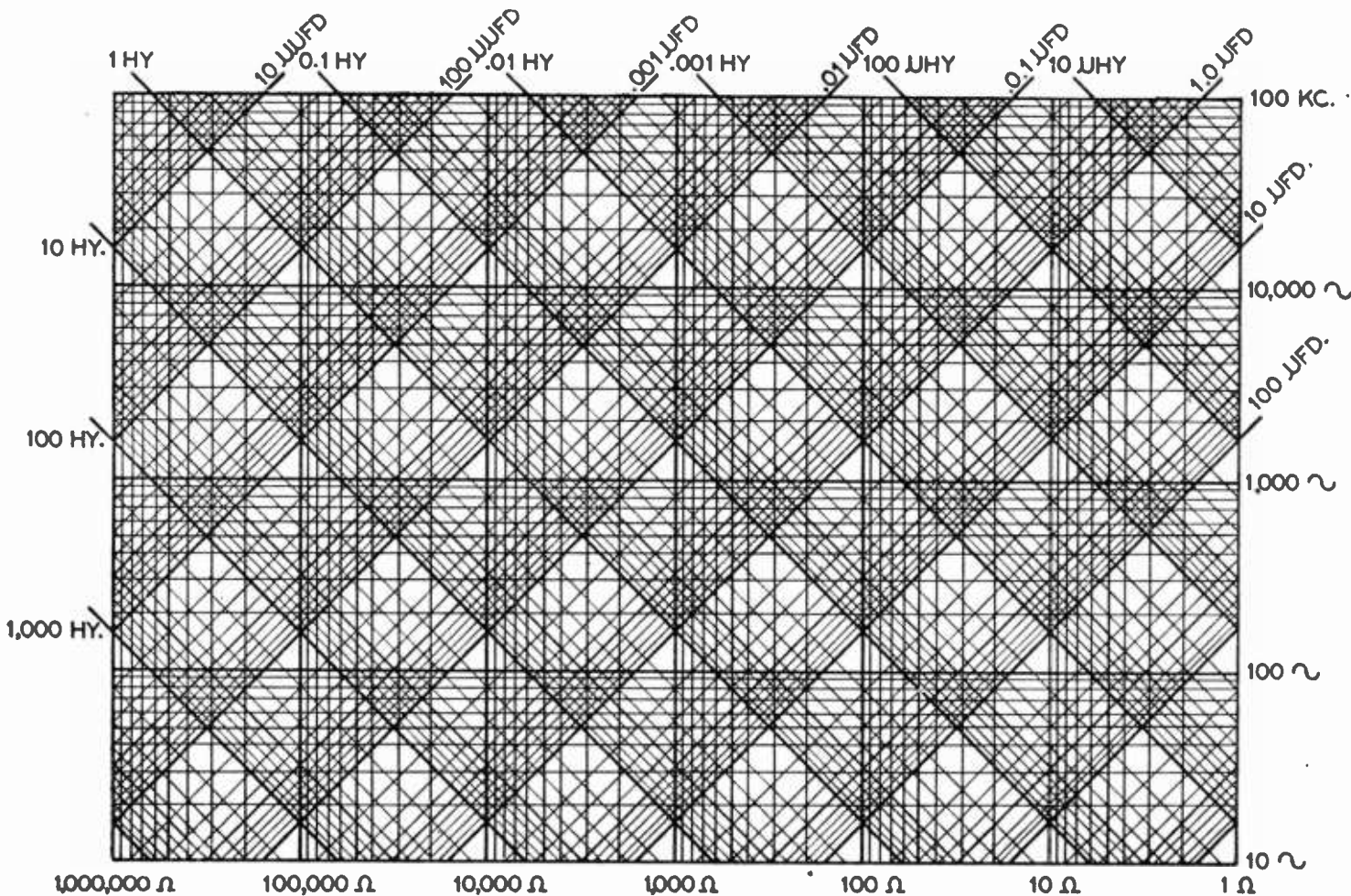

Figure 4.

REACTANCE-FREQUENCY CHART FOR AUDIO FREQUENCIES

See text for applications and instructions for use.

where P_o stands for the output power, P_i for the input power and N_{db} for the number of decibels. When the answer is positive, there is a gain; when the answer is negative, there is a loss.

Sometimes it is more convenient to figure decibels from voltage or current ratios or gains rather than from power ratios. This applies especially to voltage amplifiers. The equation for this is

$$N_{db} = 20 \log \frac{E_o}{E_i} \text{ or } 20 \log \frac{I_o}{I_i}$$

where the subscript, o , denotes the output voltage or current and, i , the input voltage or current. Note that the impedance at both output and input must be the same for the use of this equation.

Reactance Calculations

In audio frequency calculations, an accuracy to better than a few per cent. is seldom required, and when dealing with calculations involving inductance, capacitance, resonant frequency, etc., it is much simpler to make use of reactance-frequency charts such as those on pages 203-204 rather than to wrestle with a combination of unwieldy formulas. From these charts it is possible to determine the reactance of a capacitor or coil if the capacitance or inductance is known, and vice versa. It follows from this that resonance calculations can be made

directly from the chart, because resonance simply means that the inductive and capacitive reactances are equal. The capacitance required to resonate with a given inductance, or the inductance required to resonate with a given capacitance, can be taken directly from the chart.

While the chart may look somewhat formidable to one not familiar with charts of this type, its application is really quite simple, and can be learned in a short while. The following example should clarify its interpretation.

For instance, following the lines to their intersection, we see that 0.1 hy. and 0.1 μ fd. intersect at approximately 1,500 cycles and 1,000 ohms. Thus, the reactance of either the coil or capacitor taken alone is about 1000 ohms, and the resonant frequency about 1,500 cycles.

To find the reactance of 0.1 hy. at say, 10,000 cycles, simply follow the inductance line diagonally up towards the upper left till it intersects the horizontal 10,000 cycles line. Following vertically downward from the point of intersection, we see that the reactance at this frequency is about 6000 ohms.

To facilitate use of the chart and to avoid errors, simply keep the following in mind: The vertical lines indicate reactance in ohms, the horizontal lines always indicate the frequency, the diagonal lines sloping to the lower right represent inductance, and the diagonal lines sloping toward the lower left indicate capacitance. Also remember that the scale is logarithmic. For instance, the next horizontal line above 1000

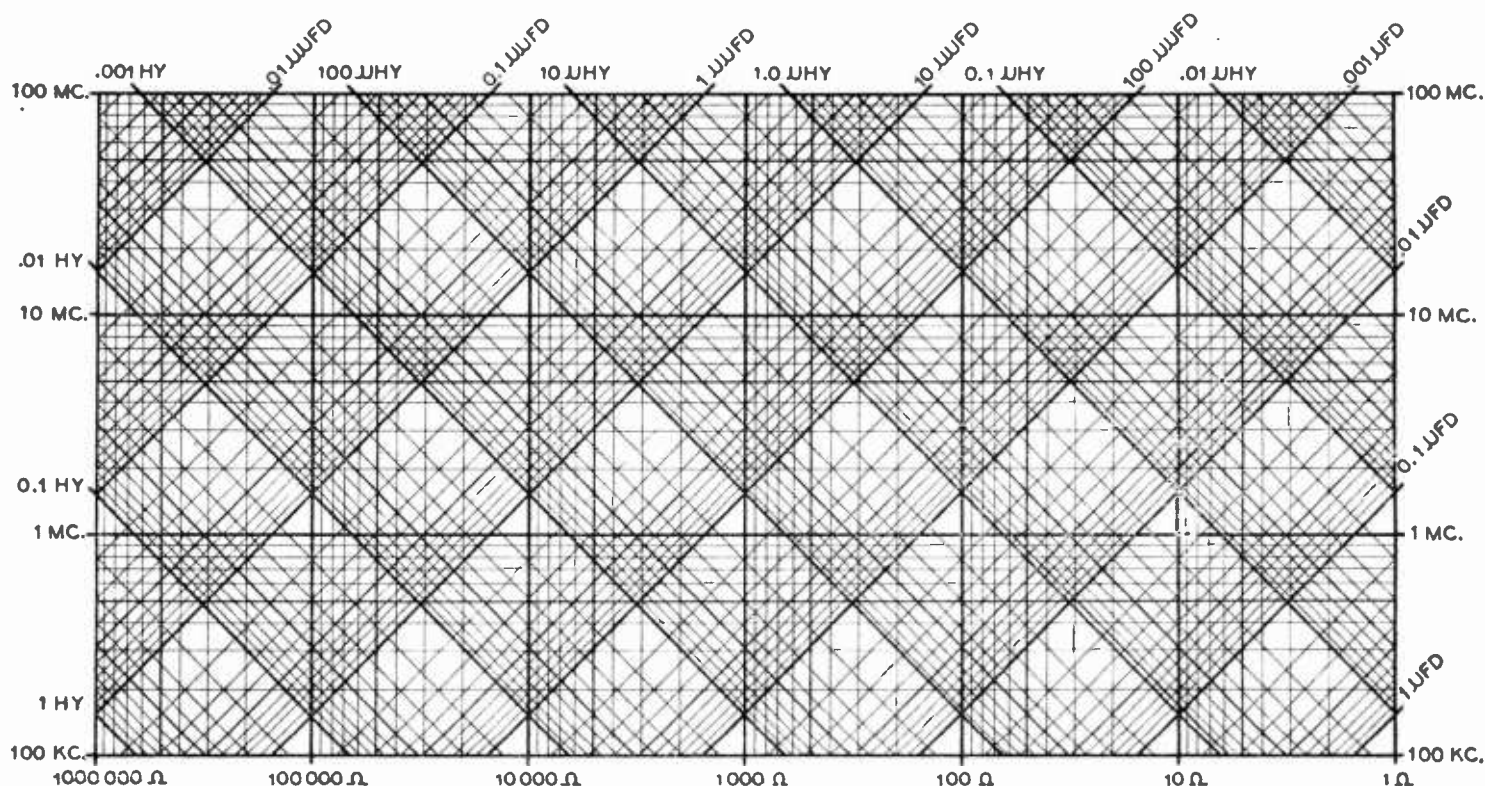

Figure 5.

REACTANCE-FREQUENCY CHART FOR R.F.

This chart is used in conjunction with the nomograph on page 202 for radio frequency tank coil computations.

cycles is 2000 cycles. Note that there are 9, not 10, divisions between the heavy lines. This also should be kept in mind when interpolating between lines when best possible accuracy is desired; halfway between the line representing 200 cycles and the line representing 300 cycles is *not* 250 cycles, but approximately 230 cycles. The 250 cycle point is approximately 0.7 of the way between the 200 cycle line and the 300 cycle line, rather than halfway between.

Use of the chart need not be limited by the physical boundaries of the chart. For instance, the 10- μ fd. line can be extended to find where it intersects the 100-hy. line, the resonant frequency being determined by projecting the intersection horizontally back on to the chart. To determine the reactance, the logarithmic ohms scale must be extended.

R. F. Tank Circuit Calculations When winding coils for use in radio receivers and transmitters, it is desirable to be able to determine in advance the full coil specifications for a given frequency. Likewise, it often is desired to determine how much capacitance is required to resonate a given coil so that a suitable capacitor can be used.

Fortunately, extreme accuracy is not required, except where fixed capacitors are used across the tank coil with no provision for trimming the tank to resonance. Thus, even though it may be necessary to estimate the stray circuit capacitance present in shunt with the tank capacitance, and to take for granted the likelihood of a small error when using a chart instead of the formula upon which the chart was based, the results will be sufficiently accurate in most cases, and in any case give a reasonably close point from which to start "pruning."

The inductance required to resonate with a certain capacitance is given in the chart on page 204. By means of the r-f

chart, the inductance of the coil can be determined, or the capacitance determined if the inductance is known. When making calculations, be sure to allow for stray circuit capacitance, such as tube interelectrode capacitance, wiring, sockets, etc. This will normally run from 5 to 25 micromicrofarads, depending upon the components and circuit.

To convert the inductance in microhenries to physical dimensions of the coil, or vice versa, the nomograph chart on page 202 is used. A pin and a straightedge are required. The inductance of a coil is found as follows:

The straightedge is placed from the correct point on the turns column to the correct point on the diameter-to-length ratio column, the latter simply being the diameter divided by the length. Place the pin at the point on the plot axis column where the straightedge crosses it. From this point lay the straightedge to the correct point on the diameter column. The point where the straightedge intersects the inductance column will give the inductance of the coil.

From the chart, we see that a 30 turn coil having a diameter-to-length ratio of 0.7 and a diameter of 1 inch has an inductance of approximately 12 microhenries. Likewise any one of the four factors may be determined if the other three are known. For instance, to determine the number of turns when the desired inductance, the D/L ratio, and the diameter are known, simply work backwards from the example given. In all cases, remember that the straightedge reads either turns and D/L ratio, *or* it reads inductance and diameter. It can read no other combination.

The actual wire size has negligible effect upon the calculations for commonly used wire sizes (no. 10 to no. 30). The number of turns of insulated wire that can be wound per inch (solid) will be found in the copper wire table on page 355.

Radio Receiving Tube Characteristics

Footnote references for standard and special-purpose receiving tubes are given on this page. References for television and cathode-ray tubes are given at the end of this chapter with the socket connections for the various types of cathode-ray tubes.

A suffix (G) in parentheses after a standard octal base tube indicates that the tube also is manufactured with glass envelope, a suffix (GT) indicating that the tube also is manufactured with small tubular glass envelope. Thus 6J5 (G) (GT) indicates that this tube is available with metal, glass, or small tubular glass envelope; 6AG7 is available only in metal; and 5Y3-GT is available only in the tubular glass envelope.

Certain of the "7" series of tubes have a nominal heater rating of 7 volts instead of the usual 6.3-volt rating. The heater is the same, however, and either the "6" series or the "7" series may be used on either 6.3 or 7 volts. To simplify the tables, all such tubes are shown with a rating of 6.3 volts. The same applies to certain of the "14" series of tubes, these tubes having the same heater as corresponding tubes of the "12" series but a nominal heater rating of 14 volts instead of 12.6 volts.

Socket terminals shown as unused in the table of socket connections should not be used as tie-points for other wiring unless the tube has no corresponding pin, because "dead" pins are sometimes used as element supports.

When a "G" or "GT" octal base tube is used, the shell

grounding terminal (usually pin no. 1) for the corresponding metal counterpart should be connected to ground the same as for a metal tube, as many "G" and "GT" types contain an internal shield.

Tube Base Connections There are from 4 to 14 pins on the bases of the various receiving-tube and cathode-ray tube types. On the 4, 6, and 7 pin bases the two heavier pins are those for the filament or heater connections. All socket connection data is given for the bottom views. When two heavy pins are used for heater connection the most clockwise of the two is called pin 1 and all other pins are numbered in a clockwise direction from this pin. In the case of sockets with a locating key the first pin clockwise from the locating key is number one pin and all successive pin positions are numbered clockwise from number one pin.

The letter F-F or H-H designate filament or heater, C or K is for cathode, P is for the plate, etc., in socket connections or wiring diagrams. The grids in multigrid tubes are numbered with respect to the position they occupy: no. 1 grid is closest to the cathode, no. 2 is next closest, and so on until the plate is reached. In certain tube types where a very low grid-to-plate capacitance is desired the grid is brought out of the top of the envelope. However, it is possible to obtain sufficiently low feedback capacitance for all practical applications through the use of the modern single-ended tube.

FOOTNOTE REFERENCES FOR STANDARD AND SPECIAL RECEIVING TUBES

¹For grid leak detection, plate volts 45, grid return to plus filament.

²Either a.c. or d.c. may be used on the filament or heater, except as specifically noted. For use of d.c. on filament types, decrease stated grid volts by 1/2 of filament voltage.

³Supply voltage applied through 20,000-ohm dropping resistor.

⁴Mercury vapor type.

⁵Grid no. 1 is control grid; grid no. 2 is screen; grid no. 3 is tied to cathode.

⁶Grid no. 1 is control grid. Grids nos. 2 and 3 tied to plate.

⁷Grids nos. 1 and 2 connected together; grid no. 3 connected to plate.

⁸Grids nos. 3 and 5 are screen. Grid no. 4 is control grid (input).

⁹Grids nos. 2 and 4 are screen. Grid no. 1 is control grid (input).

¹⁰For grid of following tube.

¹¹Power output is for 2 tubes at stated plate-to-plate load.

¹²For 2 tubes.

¹³Preferably obtained by using 70,000-ohm dropping resistor in series with 90-volt supply.

¹⁴Grids nos. 2 and 3 tied to plate.

¹⁵Applied through plate resistor of 250,000 ohms or 500-hy. choke shunted by 250,000-ohm resistor.

¹⁶Applied through plate resistor of 100,000 ohms.

¹⁷Applied through plate resistor of 250,000 ohms.

¹⁸50,000 ohms.

¹⁹Grid no. 3 tied to plate.

²⁰Plate voltages greater than 125 volts r.m.s. require 100-ohm (min.) series plate resistor.

²¹For signal input control grid. Grid no. 3 bias, minus 3 volts.

²²Grids nos. 2 and 4 are screen. Grid no. 3 is control grid.

²³Maximum.

²⁴Grids nos. 1 and 2 tied together.

²⁵Designed especially for hearing aid use.

²⁶"X" types have removable octal base. Types without "X" have peanut-type bases.

²⁷Operates into crystal earphone.

²⁸Power output is for one tube at stated plate-to-plate load.

²⁹Per plate.

³⁰Values are for each unit.

³¹D.c. resistance in grid circuit should not exceed 1.0 megohm under maximum rated conditions per unit.

³²Values are for two tubes with filaments in series; equivalent to one type 5Y3-GT/5Y3-G.

³³Types with suffixes "M", "ML", and "S" have external shield connected to cathode pin.

³⁴Triode section.

³⁵Pentode section.

TYPE	DESIGN	BASE	CATHODE TYPE & RATING		INTERELECTRODE CAPACITANCES		USED AS	PLATE SUPPLY (VOLTS)	GRID BIAS (VOLTS)	SCREEN SUPPLY (VOLTS)	SCREEN CURRENT (MA.)	PLATE CURRENT (MA.)	R.P. AC. PLATE RESISTANCE (OHMS)	G.M. TRANS-CONDUCTANCE (UMHOS)	AMPLIFICATION FACTOR	LOAD FOR STATED POWER OUTPUT (OHMS)	POWER OUTPUT (WATTS)
			F = FILAMENT HEATER TYPE	VOLTS AMP.	IN. (CGK)	OUT. GRID-PLATE (CPK)											
BA	Full-Wave Rectifier	4J	F	6.3 0.3			Rectifier										
8H	Full-Wave Rectifier	4J	F	6.3 0.3			Rectifier										
8R	Half-Wave Rectifier	4H	F	6.3 0.3			Rectifier										
LA	Power Amplifier Pentode	5B	F	6.3 0.3			Class A Amplifier										
PZ	Power Amplifier Pentode	5B	F	2.5 1.75			Class A Amplifier										
PZH	Power Amplifier Pentode	6B	H	2.5 1.75			Amplifier										
XX8	Twin-Triode Frequency Converter		F	1.4 0.1 2.8 0.05			Ratings for each section	90	0	--	--	4.5 1.4	11200 1800	1300 760	14.5	--	--
XXD	Twin-Triode	8AC	H	12.6 0.15			Each unit as Class A Amplifier										
XXEM	Twin-Diode Triode	8BZ	H	6.3 0.3			Triode unit as Class A Amplifier Diode sections	100 250	0 -1	-- --	-- --	1.2 1.9	85000 85000	1000 1500	85 100	-- --	-- --
XXL	Triode	5AC	H	6.3 0.3			Class A Amplifier	100 250	0 -8	-- --	-- --	10 8	7000 8700	3600 2300	25 20	-- --	-- --
00-A	Detector Triode	4D	D.C. F	5.0 0.25	3.2 8.5	2.0	Grid-Leak Detect.	45	Grid return to (-) filament			1.5	30000	666	20	--	--
0J-A	Detector-Amplifier Triode	4D	D.C. F	5.0 0.25	3.1 8.1	2.2	Class A Amplifier	90 135	-4.5 -9.0	-- --	-- --	2.5 3.0	11000 10000	725 800	8.0 8.0	-- --	-- --
0Z3	Full-Wave Gas Rectifier	5H	F	-- --			Rectifier										
0Z4(G)	Full-Wave Gas Rectifier	4R	F	-- --			Rectifier										
0Z4/1003	Full-Wave Gas Rectifier	4R	F	-- --			Rectifier										
1A3	H.F. Diode	5AP	H	1.4 0.15			Detector Rectifier										
1A4p	Super-Control R.F. Amplifier Pentode	4M	D.C. F	2.0 0.06	5.0 11.0	0.007	Amplifier										
1A4T	Super-Control R.F. Amplifier Tetrode	4K	D.C. F	2.0 0.06			Amplifier										
1A5-GT/G	Power Amplifier pentode	6X	D.C. F	1.4 0.05			Class A Amplifier	85 90	-4.5 -4.5	85 90	0.7 0.8	3.5 4.0	300 000 300 000	800 850	240 255	25 000 25 000	0.100 0.115
1A6	Pentagrid Converter (C)	6L	D.C. F	2.0 0.06	10.5 9.0	0.25	Converter										
1A7-GT/G	Pentagrid Converter (B)	7Z	D.C. F	1.4 0.05	7.0 10.0	0.5	Converter	90	0	45	0.7	2.6	600 000	1100	--	--	--
1A85	Pentode R.F. Amplifier	5BF	D.C. F	1.2 0.130	2.8 4.2	0.25	R.F. Amplifier	90 150	0 -1.5	90 150	0.8 2.0	3.5 6.8	275 000 125 000	1100 1350	--	--	--
1B4-P	Pentode R.F. Amplifier	4M	D.C. F	2.0 0.06	5.0 11.0	0.007	Amplifier										

		For other characteristics, refer to type 1H4-G															
1B5/25S	Duplex-Diode Triode	6M	D.C. F	2.0	0.06	1.6	1.9	3.6	Triode unit as Amplifier	90	45	1.3	1.5	350 000	350	Grid No. 2, 0i volts, 1.6 V.A.	
1B7-GT/G	Pentagrid Converter	7Z	D.C. F	1.4	0.10	7.0	7.5	0.34	Oscillator-Amp- lifier converter	90	Triode 0 Beam Amp-0	1.4	0.15 6.3	240 000	275 1150	66 --	14 000 0.210
1B8-GT	Multi-Purpose	8AW	D.C. F	1.4	0.10				Diode-Triode Beam Amplifier	90							
1C4	Super Control R.F. Amplifier Pentode	4M	D.C. F	2.0	0.12				Amplifier	180	0	0.9	2.5	1000 000	1000	--	--
1C5-GT/G	Power Amplifier Pentode	6X	D.C. F	1.4	0.10				Class A Amplifier	83	-7.0	1.6	7.0	110 000	1500	9000	0.200
1C6	Pentagrid Converter (6)	6L	D.C. F	2.0	0.12	10.0	10.0	0.30	Converter	90	-7.5	1.6	7.5	115 000	1550	8000	0.240
1C7-G	Pentagrid Converter (6)	7Z	D.C. F	2.0	0.12	10.0	14.0	0.26	Converter	135 180	-5.0 -3.0	2.5 2.0	1.3 1.5	600 000 700 000			
1D4(G)GT	Power Amplifier Pentode	5B	D.C. F	2.0	0.24				Class A Amplifier	180	-6.0	2.3	9.5	137 000	2400	330	15 000 0.750
1D5-GP	Super Control R.F. Amplifier Pentode	5Y	D.C. F	2.0	0.06				Class A Amplifier	90 180	-3.0 -3.0	0.9 0.8	2.2 2.3	600 000 1000 000	720 750	423 750	--
1D5-GT	Super Control R.F. Amplifier Pentode	5R	D.C. F	2.0	0.06				Amplifier	135 180	-3.0 -3.0	0.7 0.7	2.2 2.2	350 000 600 000	625 650	219 390	--
1D7-G	Pentagrid Converter (6)	7Z	D.C. F	2.0	0.06	10.5	9.0	0.25	Converter	135 180	-3.0 -3.0	2.5 2.4	1.2 1.3	400 000 500 000			
1D8-GT	Diode-Triode Power Amplifier Pentode	8AJ	D.C. F	1.4	0.10				Pentode unit as Class A Amplifier Triode unit as Class A Amplifier	45 90 45 90	-4.5 -9.0 0 0	0.3 1.0 -- --	1.6 5.0 0.3 1.1	300 000 200 000 77 000 43 500	650 925 325 575	195 195 25 25	20 000 12 000 -- --
1E4-G	General Purpose Triode	5S	D.C. F	1.4	0.05	2.4	6.0	2.4	Amplifier	90	-3.0	--	1.5	17 000	825	14	--
1E5-GP	R.F. Amplifier Pentode	5Y	D.C. F	2.0	0.06	5.0	11.0	0.007	Class A Amplifier	90 180	-3.0 -3.0	0.7 0.6	1.6 1.7	1000 000 1500 000	600 650	550 1000	--
1E7-G	Twin-Pentode Power Amplifier	8C	D.C. F	2.0	0.20				Push-pull Class A Amplifier	135	-7.5	2.0	7.0	260 000	1425	370	24 000 0.575 (2)
1F4	Power Amplifier Pentode	5K	D.C. F	2.0	0.12				Amplifier	90							
1F5-G	Power Amplifier Pentode	6X	D.C. F	2.0	0.12				Class A Amplifier	90 135	-3.0 -4.5	1.1 2.4	4.0 8.0	240 000 200 000	1400 1700	336 340	20 000 16 000
1F6	Duplex-Diode Pentode	6W	D.C. F	2.0	0.06	4.0	8.0	0.007	Pentode unit as Class A Amplifier	90	0	--	2.3	10 700	825	8.8	--
1F7-G(GV)	Duplex-Diode Pentode	7AD	D.C. F	2.0	0.06	3.8	9.5	0.01	Pentode Unit as R.F. Amplifier Pentode unit as A.F. Amplifier	180 135 (17)	-1.5 -2.0	0.7 1.0	2.2 1.0	1000 000	650	650	--
1Q4-GT/G	Detector Amplifier Triode	5S	D.C. F	1.4	0.05	2.2	3.4	2.8	Class A Amplifier	90	-6.0	--	2.3	10 700	825	8.8	--
1G5-G	Power Amplifier Pentode	6X	D.C. F	2.0	0.12				Class A Amplifier	90 135	-6.0 -13.5	2.5 2.5	8.5 8.7	133 000 160 000	1500 1550	200 250	8500 9000
1G6-GT/G	Twin-Triode Amplifier	7AB	D.C. F	1.4	0.10				Class B Amplifier	90	0	--	2.0	--	--	--	12 000 0.675 (2)
1H4-G	Detector Amplifier Triode (1)	5S	D.C. F	2.0	0.06				Class A Amplifier Class B Amplifier	90 180 157.5	-4.5 -13.5 -15.0	-- -- --	2.5 3.0 3.1 1.0 (12)	11 000 10 300 10 300 --	850 900 900 --	9.3 9.3 9.3 --	-- -- 8000 2.1 (11)

TYPE	DESIGN	BASE	CATHODE TYPE & RATING		INTERELECTRODE CAPACITANCES (pF)		USED AS	PLATE SUPPLY (VOLTS)	GRID BIAS (VOLTS)	SCREEN SUPPLY (VOLTS)	SCREEN CURRENT (MA.)	PLATE CURRENT (MA.)	R.P. AC-PLATE RESISTANCE (OHMS)	G.M. TRANSDUCANCE (μMHOS)	A.M.P. GAIN FACTOR	LOAD FOR STATED POWER OUTPUT (OHMS)	POWER OUTPUT (WATTS)
			F = FILAMENT HEATER	H = HEATER	IN. (CGK)	OUT. (C-PK) PLATE											
1H5-GT/G	Diode High-Mu Triode	5Z	D.C. F	1.4	0.05	1.1	4.6	1.0	90	0	--	0.15	240 000	275	65	--	--
1H6-G	Duplex-Diode Triode	7AA	D.C. F	2.0	0.06				135	-3.0	--	0.8	35 000	575	20	--	--
1J5-G	Power Amplifier Pentode	6X	D.C. F	2.0	0.12				135	-16.5	1.8	7.0	125 000	1000	125	13 500	0.450
1J6-G	Twin-Triode Amplifier	7AB	D.C. F	2.0	0.24				135	0	--	5.0	--	--	--	10 000	2.1
1L4	R.F. Amplifier Pentode	6AR	D.C. F	1.4	0.05	3.6	7.5	0.008	90	0	67.5	2.9	600 000	925	555	10 000	1.9
1L4	R.F. Amplifier Pentode	6AR	D.C. F	1.4	0.05	3.6	7.5	0.008	90	0	90	4.5	350 000	1025	360	--	--
1L4	Power Amplifier Pentode	5AD	D.C. F	1.4	0.05				90	0	--	5.0	--	--	--	10 000	2.1
1L46	Pentagrid Converter	7AK	D.C. F	1.4	0.05	7.7	8.0	0.4	90	0	45	0.55	750 000				
1L84	Power Amplifier Pentode	5AD	D.C. F	1.4	0.05				90	-9.0	1.0	5.0	200 000	925	185	12 000	0.200
1LB6(GL)	Pentagrid Converter	8AX	D.C. F	1.4	0.05				90	0	67.5	0.4	2000 000	100			
1LC5	R.F. Amplifier Pentode	7AO	D.C. F	1.4	0.05	3.2	7.0	0.007	45	0	45	1.1	700 000	750	525	--	--
1LC5	R.F. Amplifier Pentode	7AO	D.C. F	1.4	0.05	3.2	7.0	0.007	90	0	45	1.15	1500 000	775	1160	--	--
1LC6	Pentagrid Converter	7AK	D.C. F	1.4	0.05	2.4	5.5	0.28	45	0	35	0.75	300 000				
1LC6	Pentagrid Converter	7AK	D.C. F	1.4	0.05	2.4	5.5	0.28	90	0	35	0.75	600 000				
1LD5	Diode-Pentode	6AX	D.C. F	1.4	0.05	3.2	6.0	0.18	45	0	45	0.12	900 000	550	495	--	--
1LD5	Diode-Pentode	6AX	D.C. F	1.4	0.05	3.2	6.0	0.18	90	0	45	0.60	750 000	575	430	--	--
1LE3	General Purpose Triode	4AA	D.C. F	1.4	0.05	1.7	3.0	1.7	90	0	45	1.7	1000 000	800	--	--	--
1LG5	R.F. Amplifier Pentode	7AO	D.C. F	1.4	0.05	3.2	7.0	.007	90	0	45	0.4	240 000	275	65	--	--
1LH4	Diode-High-Mu Triode	5AG	D.C. F	1.4	0.05				90	0	--	0.15	240 000				
1LM5	R.F. Amplifier Pentode	7AO	D.C. F	1.4	0.05	3.0	8.0	0.007	90	0	90	1.2	1500 000	750	1160	--	--
1M5-GT/G	R.F. Amplifier Pentode	5Y	D.C. F	1.4	0.05	3.4	10.0	0.007	90	0	90	0.3	300 000	800	240	25 000	0.100
1M6-G	Diode-Power Amplifier Pentode	7AM	D.C. F	1.4	0.05				90	-4.5	0.7	3.4	800 000	750	640	--	--
1P5-GT	R.F. Amplifier Pentode	5Y	D.C. F	1.4	0.05	2.2	10.0	0.007	90	0	90	0.7	800 000	750	640	--	--
1Q5-GT/G	Beam Power Amplifier	6AF	D.C. F	1.4	0.10				90	-4.5	1.3	9.5	75 000	2200	165	8000	0.270
1R4	I.H.F. Diode	4AH	H	1.4	0.15	--	0.36	--	10 V., R.M.S.			1.0					
1R5	Pentagrid Converter	7AT	D.C. F	1.4	0.05	7.0	7.5	0.1	45	0	45	1.9	600 000				
1R5	Pentagrid Converter	7AT	D.C. F	1.4	0.05	7.0	7.5	0.1	67.5	0	67.5	3.2	600 000				
1S4	Power Amplifier Pentode	7AV	D.C. F	1.4	0.10				45	-4.5	0.8	3.8	100 000	1250	125	8000	0.065
1S4	Power Amplifier Pentode	7AV	D.C. F	1.4	0.10				90	-7.0	1.4	7.4	100 000	1575	158	8000	0.270
1S5	Diode-Pentode	6AU	D.C. F	1.4	0.05	2.2	2.4	0.2	67.5	0	67.5	0.4	600 000	625			
1S5	Diode-Pentode	6AU	D.C. F	1.4	0.05	2.2	2.4	0.2	67.5	0	67.5	0.4	600 000	625			
1SAG-GT	R.F. Amplifier Pentode	6BD	D.C. F	1.4	0.05				90	0	67.5	2.45	800 000	970	775	--	--
1SB6-GT	Diode-Pentode	6BE	D.C. F	1.4	0.05				90	0	67.5	1.45	700 000	665	465	--	--

Type	Application	D.C. F	1.4	0.05	3.6	7.5	0.01	Class A Amplifier	45 90	0 0	0.7 1.4	1.7 3.5	350 000 500 000	700 900	245 450	--	--		
1T4	Super-Control R.F. Amplifier Pentode	D.C. F	1.4	0.05	3.6	7.5	0.01	Class A Amplifier	45 90	0 0	0.7 1.4	1.7 3.5	350 000 500 000	700 900	245 450	--	--		
1T5-6T	Beam Power Amplifier	D.C. F	1.4	0.05	4.8	8.0	0.5	Class A Amplifier	90	-6.0	1.4	6.5	--	1150	--	14 000	0.170		
1U4	H.F. Amplifier Pentode	D.C. F	1.4	0.05	3.6	7.5	.008	R.F. Amplifier	90	-4.5	0.45	1.6	1500 000	900	--	--	--		
1U5	Diode-Pentode Amplifier	D.C. F	1.4	0.05				Class A Amplifier	For other characteristics refer to 1S5										
1V	Half-wave Rectifier	H	6.3	0.3				With condenser input filter	385				Minimum total effective plate supply impedance: up to 117 volts, 0 Ohms; At 160 volts, 30 Ohms; At 325 volts, 75 Ohms						
2A3	Power Amplifier Triode	F	2.5	2.5	7.5	5.5	16.5	Class A Amplifier push-pull class AB Amplifier	250 300 300	-45.0 Cathode bias, 760 ohms -62 volt, fixed bias	-- 80.0 80.0	60.0 (12)	800 --	5250 --	4.2 --	2500 5000 3000	3.5 10.0 15.0		
2A5	Power Amplifier Pentode	H	2.5	1.75				Amplifier	For other characteristics, refer to type 6F6										
2A6	Duplex-Diode High-Vu Triode	H	2.5	0.8	1.7	3.8	1.7	Triode Unit as Amplifier	For other characteristics, refer to type 6BQ7										
2A7	Pentagrid Converter (6)	H	2.5	0.8	8.5	9.0	0.3	Converter	For other characteristics, refer to type 6A7										
2B6	Direct-coupled Amplifier	H	2.5	2.25				Amplifier	250	-24.0	--	40.0	5150	3500	18	5000	4.0		
2B7	Duplex-Diode Pentode	H	2.5	0.8				Pentode Unit as Amplifier	For other characteristics, refer to type 6B8-6										
2C21/1642	Twin-Triode Amplifier	H	6.3	0.6	2.6	1.4	2.4	Class A Amplifier	250	-16.5	--	8.3	7600	1375	10.4	--	--		
2C22	Triode Amplifier	H	6.3	0.3	2.2	0.7	3.6	Class A Amplifier	300	-10.5	--	11.0	6600	3000	20	--	--		
2E5	Electron-Ray Tube	H	2.5	0.8				Tuning Indicator	For other characteristics, refer to type 6E5										
2G5	Electron-Ray Tube	H	2.5	0.8				Visual Indicator	250	-28	For θ^0 shadow angle	Target 250	Plate voltage supplied through 1 Megohm Resistor						
2S/4S	Duplex-Diode Half-Wave Rectifier	H	2.5	1.35				Detector	The two Diode plates each rated approx. 30 MA. with 50 volts D.C. on the plates										
2W3(GT)	Half-Wave Rectifier	F	2.5	1.5				Rectifier	Maximum A.C. voltage 300 volts (RMS) Maximum D.C. output current 55 Milliamperes										
2X3 (6)	Half-Wave Rectifier	F	2.5	2.0				With condenser input filter	360				Max. D.C. Output MA., 125	Minimum total effective supply impedance, 10 Ohms					
2Z2/664	Half-Wave Rectifier	F	2.5	1.5				With choke-input filter	500				Max. A.C. Plate Volts (RMS), 1400	Minimum value of input choke, 5 Henries					
3A4	Power Amplifier Pentode	D.C. F	1.4 2.8	0.2 0.1	4.8	4.2	0.34	Class A Amplifier Parallel Filament R.F. Power Amp. Parallel Filament	135 150 150	-7.5 -8.4 --	90 90 135	2.6 2.2 6.5	90 000 100 000 Grid Current, 0.13 MA	1900 1900 --	-- -- --	8000 8000 --	0.6 0.7 1.2 at 10 MC.		
3A5	H.F. Tuning-Triode	D.C. F	1.4 2.8	0.22 0.11	0.9	1.0	3.2	Class A Amplifier Push-pull Class C Amplifier	90 135	-2.5 -20.0	-- From grid resistor of 4000 ohms	3.7	8300	1800	15	--	--	2.0 at 40 MC.	
3A6-6T	Diode-Triode H.F. Amplifier	D.C. F	1.4 2.8	0.1 0.05	2.5 3.0	4.2 1.0	2.5 0.12	Triode unit as Class C Amplifier Pentode unit as Class A Amplifier	90 90	0 0	-- --	0.2 1.5	200 000 800 000	325 750	65	--	--	--	
3B5-6T	Beam Power Amplifier	D.C. F	1.4 2.8	0.1 0.05				Class A Amplifier	67.5 67.5	-7.0 -7.0	67.5 67.5	0.6 0.5	100 000 100 000	1650 1500	-- --	5000 5000	0.2 0.18		
3B7	VHF Tuning-Triode	D.C. F	1.4 2.8	0.22 0.11	1.4	1.8	2.6	Class H Amplifier	185 90	0 0	-- --	19 10.4	-- --	1900 1850	20	8000 10000	1.5 1.0		
3C5-6T	Power Amplifier Pentode	D.C. F	1.4 2.8	0.10 0.05				Class A Amplifier	90 90	-9.0 -9.0	90 90	1.4 1.4	-- --	1950 1950	-- --	8000 10000	0.24 0.26		
3D6	Beam Power Amplifier	D.C. F	1.4 2.8	0.22 0.11	7.5	5.5	0.30	Class A Amplifier	150 135	-4.5 -4.5	90 90	1.0 1.2	-- --	2400 2400	-- --	14000 12000	0.6 0.5		

TYPE	DESIGN	BASE	CATHODE TYPE & RATING		INTERELECTRODE CAPACITANCES (pF)			USED AS	PLATE SUPPLY (VOLTS)	GRID BIAS (VOLTS)	SCREEN SUPPLY (VOLTS)	SCREEN CURRENT (MA.)	PLATE CURRENT (MA.)	AC. PLATE RESISTANCE (OHMS)	GM TRANS-CONDUCTANCE (μMHOS)	JJ AMPLIFICATION FACTOR	LOAD FOR STATED POWER OUTPUT (OHMS)	POWER OUTPUT (WATTS)
			F FILAMENT	H HEATER	IN. (CGK)	OUT. (CPK)	PLATE											
3E6	R.F. Amplifier Pentode	7CJ	D.C. 1.4 F 2.8	0.10 0.05	5.5	8.0	.007	90	-4	90	0.8	2.7	300 000	1700	--	--	--	
3LE4	Power Amplifier Pentode	68A	D.C. 1.4 F 2.8	0.1 0.05				90	-9.0	90	2.0	10.0	100 000	1700	--	6000	0.325	
3LF4	Power Amplifier Pentode	68B	D.C. 1.4 F 2.8	0.1 0.05				90	-4.5	90	1.3	9.5	750 000	2200	--	8000	0.27	
3Q4	Power Amplifier Pentode	78A	D.C. 1.4 F 2.8	0.1 0.05				90	-4.5	90	2.1	9.5	100 000	2150	--	10000	0.27	
3Q5-6T/6	Beam Power Amplifier	7AP	D.C. 1.4 F 2.8	0.1 0.05	8.0	6.5	0.6	90	-4.5	90	1.3	9.5	100 000	2100	--	8000	0.27	
3S4	Power Amplifier Pentode	78A	D.C. 1.4 F 2.8	0.1 0.05				90	-7.0	67.5	1.4	7.4	100 000	1575	--	8000	0.27	
3V4	Power Amplifier Pentode	68X	D.C. 1.4 F 2.8	0.1 0.05	5.5	3.8	.20	90	-1.5	--	--	2.2	13 300	1500	20	8000	1.0	
4A6-G	Twin Triode Amplifier	8L	D.C. 4.0 F 2.0	0.06 0.12				90	0	--	--	4.6	--	--	--	--	--	
4S	Duplex Diode	5D	H 2.5	1.35														
5B4-GY	Full-wave Rectifier	5T	F 5.0	2.0														
5T4	Full-wave Rectifier	5T	F 5.0	2.0														
5U4-G	Full-wave Rectifier	5T	F 5.0	3.0														
5V4-G	Full-wave Rectifier	5L	H 5.0	2.0														
5W4(6T)(G)	Full-wave Rectifier	5T	F 5.0	1.5														
5X3	Full-wave Rectifier	4C	F 5.0	2.0														
5X4-G	Full-wave Rectifier	5Q	F 5.0	3.0														
5Y3-6T/6	Full-wave Rectifier	5T	F 5.0	2.0														
5Y4-G	Full-wave Rectifier	5Q	F 5.0	2.0														
5Z3	Full-wave Rectifier	4C	F 5.0	3.0														
5Z4(6T)(G)	Full-wave Rectifier	5L	H 5.0	2.0														
6A3	Power Amplifier Triode	4D	F 6.3	1.0														

For other characteristics refer to 304

For other characteristics, refer to type 28/48

For other characteristics, refer to type 5U4-G

For other characteristics, refer to type 6Y3-G

For other characteristics, refer to type 5U4-G

For other characteristics, refer to type 6B4-G

TYPE	DESIGN	BASE	CATHODE TYPE & RATING		INTERELECTRODE CAPACITANCES		USED AS	PLATE SUPPLY (VOLTS)	GRID BIAS (VOLTS)	SCREEN SUPPLY (VOLTS)	SCREEN CURRENT (MA.)	PLATE CURRENT (MA.)	R.P. A.C. PLATE RESISTANCE (OHMS)	GM TRANS-CONDUCTANCE (UMHOS)	AMPLIFICATION FACTOR	LOAD FOR STATED POWER OUTPUT (OHMS)	POWER OUTPUT (WATTS)	
			F = FILAMENT H = HEATER	TYPE VOLTS/AMP.	IN. (CGK)	OUT. (CPK) GRID-PLATE												
6AK5	r.f. Pentode	78D	H	6.3 0.175	4.0	2.8	0.02	Class A Amplifier	180	-2.0	120	2.4	7.7	690 000	5100	3500	--	
6AK6	Power Amplifier Pentode	78K	H	6.3 0.15	3.6	4.2	0.12	Class A Amplifier	180	-9.0	180	2.5	15.0	200 000	2300	--	1.1	
6AL5	VHF Tuning Diode	68T	H	6.3 0.3		3.2		Detector	Resonant frequency 700 Mc. Maximum RMS voltage: 150 volts per plate Max. D.C. output current: 8 mA. per plate									
6AL6(G)	Beam Power Amplifier	6AH	H	6.3 0.9				Class A Amplifier	250	-14.0	250	5.0	72.0	22 500	6000	--	2500	6.5
6AN6	Quadruple Diodes	Fig. 12	H	6.3 0.2				Rating for each diode	Max. A.C. volts per plate (RMS), 117 Max. D.C. output MA., 0.3 Max. peak inverse volts, 210									
6AQ5	Beam Power Amplifier	78Z	H	6.3 0.45	8.0	11.0	0.17	Class A Amplifier	250	-12.5	250	7	47	52 000	4100	--	5000	4.5
6AQ6	Duo-Diode High-Mu Triode	78T	H	6.3 0.15	1.7	1.5	1.8	Triode unit as Class A Amplifier	100 250	-1.0 -3.0	--	--	0.8 1.0	61 000 58 000	1150 1200	70 70	--	--
6AR6	Beam Power Amplifier	Fig. 13	H	6.3 1.2				Class A Amplifier	250	-22.5	250	4.0	82.5	--	5400	--	2000	10.0
6AS6	R.F. Pentode	Fig. 14	H	6.3 0.175				Class A Amplifier	For other characteristics, refer to type 6AK3									
6A57G	Twin Power Amplifier	88D	H	6.3 2.5				D.C. Amplifier	135	250 Ohm Cath. Resis.	--	--	125	--	7500	2.1	--	--
6AT6	Duplex-Diode Triode	78T	H	6.3 0.3	2.3	1.1	2.1	Class A Amplifier	250	-3	--	--	1	58 000	1200	70	--	--
6AU6	R.F. Amplifier Pentode	78K	H	6.3 0.3	5.5	5.0	0.03	R.F. Amplifier	250	-1	150	4.3	10.8	2000 000	5200	--	--	--
6B4-G	Power Amplifier Triode	5S	F	6.3 1.0				Class A Amplifier	325 325	Cathode bias, 800 Ohms -68 volts, fixed bias	--	--	80.0 80.0	--	--	--	5000 5000	10.0 15.0
6B5	Direct-Coupled Power Amplifier	6A5	H	6.3 0.8				Class A Amplifier	For other characteristics, refer to type 6AK6-G									
6B6-G	Duplex-Diode Hi-Mu Triode	7V	H	6.3 0.3	1.7	3.8	1.7	Triode Unit as Amplifier	For other characteristics, refer to type 6B47									
6BA6	R.F. Amplifier Pentode	7CA	H	6.3 0.3	5.5	5.0	0.03	R.F. Amplifier	250	-20	100	4.2	11	1500 000	4400	--	--	--
6BE6	Pentagrid Converter	7CH	H	6.3 0.3	7.2	8.6	0.05	Converter	100 250	-1.5 -1.5	100 100	7.3 7.1	2.8 3.0	500 000 1000 000	455 475	--	--	--
6BF6	Duplex-Diode Triode	78T	H	6.3 0.3	1.8	1.1	2.0	Class A Amplifier	250	-9	--	--	9.5	8 500	1900	16	10 000	0.3
6BG6-G	Beam Power Amplifier	5BT	H	6.3 0.9				Deflection Amplifier	Special application--similar char. to 807									
6B7 6B7S	Duplex-Diode Pentode	7D	H	6.3 0.3	3.5	9.5	0.007	Pentode Unit as Amplifier	For other characteristics, refer to type 6B9									
6B8(G)(GT)	Duplex-Diode Pentode	8E	H	6.3 0.3	6.0	9.0	0.005	Pentode unit as R.F. Amplifier Pentode unit as R.F. Amplifier	100 250 300	-3.0 -3.0 90	100 125	1.7 2.3	5.8 9.0	300 000 600 000	950 1125	--	--	Gain per stage, 55 Gain per stage, 79
6C4	R.F. Triode	68G	H	6.3 0.15	1.8	1.2	1.6	Class A Amplifier	250	-8.5	--	--	10.5	7 700	2200	17	--	--
6C5(GT)(G)	Detector Amplifier Triode	6P	H	6.3 0.3	3.0	11.0	2.0	Class A Amplifier Class A Amplifier	250 250	-8.0 -17.0	--	--	8.0	10 000	2000	20	--	--
6C6	Triple-Grid Detector Amplifier	6F	H	6.3 0.3	3.0	10.5	2.0	Amplifier Detector	For other characteristics, refer to type 6J7									

TYPE	DESIGN	BASE	CATHODE TYPE & RATING		INTERELECTRODE CAPACITANCES (pF)			USED AS	PLATE SUPPLY (VOLTS)	GRID BIAS (VOLTS)	SCREEN SUPPLY (VOLTS)	SCREEN CURRENT (MA.)	PLATE CURRENT (MA.)	R.F. AC. PLATE RESISTANCE (OHMS)	G.M. TRANS-CONDUCTANCE (UMHOS)	J.I. AMPLIFICATION FACTOR	LOAD FOR STATED POWER OUTPUT (OHMS)	POWER OUTPUT (WATTS)
			F = FILAMENT H = HEATER	TYPE	VOLTS	AMP.	IN. (CGK)											
6J5GT/G	Detector Amplifier-Triode	6Q	H	6.3	0.3	3.4	3.6	4.0	Class A Amplifier	90 250	0	--	10.0 9.0	6700 7700	3000 2600	20 20	--	--
6J6	Twin Triode	78F	H	6.3	0.45	2.2	0.4	1.6	Each unit as Class A Amplifier Push-Pull Class C Amplifier	100 150	-10.0	8.5 30.0	7100	5300	38	--	3.5	
6J7(G)(GT)	Triode-Grid Detector Amplifier	7R	H	6.3	0.3	7 (5) 12 (5) 0.005	14 (4) 2 (4)	0.005	Pentode A.F. Amplifier Bias Detector Triode (4) Class A Amplifier	100 250	-3.0 -8.0	0.5 0.5	2.0 2.0	1000 000 1500 000	1185 1225	--	--	--
6J8-G	Triode-Heptode Converter	8H	H	6.3	0.3	4.4	8.8	0.01	Triode Unit as Amplifier Heptode Unit as Amplifier	100 250	-3.0 -3.0	3.2 3.5	5.0 1.3 1.3	800 000 2500 000	1000 000 200 000 OHMS	20 20	--	--
6K5GT/G	High-Mu Triode	5U	H	6.3	0.3	2.4	3.6	2.0	Class A Amplifier	100 250	-1.5 -3.0	--	0.35 1.1	78 000 50 000	800 1400	70 70	--	--
6K6GT/G	Power Amplifier Pentode	7S	H	6.3	0.4	5.5	6.0	0.5	Class A Amplifier	250	-18.0	5.5	32.0	68 000	2300	--	7600	3.40
6K7(G)(GT)	Triode-Grid Super-Control Amplifier	7R	H	6.3	0.3	7	12	0.005	Class A Amplifier Mixer in Superheterodyne	90 250 250	-3.0 -3.0 -10.0	1.3 2.6	5.4 10.5	300 000 600 000	1275 1650	--	--	--
6K8(G)(GT)	Triode-Heptode Converter	8K	H	6.3	0.3	6.6	3.5	0.02	Triode Unit as Oscillator as Mixer	100 250	-3.0 -3.0	6.2 6.0	2.3 2.5	400 000 600 000	325 UMHOS Conversion Transcond., 260 UMHOS	--	--	--
6L5-G	Detector Amplifier-Triode	6Q	H	6.3	0.15	3.0	5.0	2.7	Class A Amplifier	135 250	-5.0 -9.0	--	3.5 8.0	11 300 9 000	1500 1900	17 17	--	--
6L6(G)	Beam-Power Amplifier	7AC	H	6.3	0.9	10	12	0.4	Single Tube Class A Amplifier Push-Pull Class A Amplifier Push-Pull Class AB ₂ Amplifier Push-Pull Class AB ₂ Amplifier Single Triode (19) Class A Amplifier	250 250 270 360 360 360 250 250	-14.0 -17.5 -17.5 -22.5 -22.5 -18.0 -20.0	5.0 5.4 11.0 (12) 134.0 (12) 5.0 (12) 88.0 (12) 3.5 (12) 5.0 (12) 40.0	72.0 75.0	22 500 23 500 23 500	6000 5700	--	2500 2500 5000 5000 6600 9000 6000 3800 5000 6000	6.5 6.5 17.5 18.5 26.5 24.5 31.0 47.0 1.4 1.3
6L7(G)	Pentagrid Mixer Amplifier	7T	H	6.3	0.3	7.5	11	0.001	Mixer in Superheterodyne Class A Amplifier	250 250	-3.0 -3.0 (5)	7.1 6.5	2.4 5.3	600 000 1100	9500	--	7000	4.4
6M6-G	Power Amplifier Pentode	7S	H	6.3	1.2				Class A Amplifier	250	-6.0	4.0	36.0	900 000	3400	--	--	--
6M7-G	R.F. Amplifier Pentode	7R	H	6.3	0.3				R.F. Amplifier	250	-2.5	2.8	10.5	91 000	1100	--	--	--
6M8-G(GT)	Diode-Triode Pentode	8AD	H	6.3	0.6				Triode Unit as A.F. Amplifier Pentode Unit as R.F. Amplifier	100 100	-1.0 -3.0	--	0.5 8.5	200 000 1900	1900	--	--	--
6M4	H.F. Triode	Fig. 15	H	6.3	0.2				Class A Amplifier	180	-3.5	--	12.0	6000	6000	32.5	--	--
6N5(G)	Electron-Ray Tube	6R	H	6.3	0.15				Visual Indicator									

For other characteristics, refer to type 6AM5

Tube	Direct-Coupled Power Amplifier	7AU	H	6.3	0.8	5.5	3.4	3.0	2.0	Class A Amplifier (As Driver)	250	-5.0	6.0	11 300	3100	35	20 000 μ r more	4.0
6N6-G	Twin-Triode Amplifier	88	H	6.3	0.8	3.0	3.4	3.0	2.6	Class A Amplifier (As Driver)	250	-5.0	6.0	11 300	3100	35	20 000 μ r more	4.0
6N7(GT)(G)	Detector Amplifier Triode	6Q	H	6.3	0.3	3.4	3.4	5.5	2.6	Class A Amplifier	250	-13.5	2.5	12 000	1150	13.8	--	--
6P5-GT/6	Triode Pentode	7U	H	6.3	0.3	3.5	3.0	3.0	2.0	Triode Unit as Oscillator	100	-3.0	2.4	16 200	525	8.5	D.C. Grid current = 0.15 Milliamperes	--
6P7-G	Triode Hexode	8K	H	6.3	0.8	3.8	3.8	3.8	2.4	Triode Unit as Mixer	250	-10.0	0.6	2000 000	1200	70	Conversion Transcond.: 300 μ MHOS	--
6P8-G	Diode-Triode	6Y	H	6.3	0.15	3.8	3.8	3.8	1.4	Triode Unit as Class A Amplifier	250	-3.0	1.2	--	1050	65	--	--
6P9(GT)(GT)	Duplex-Diode High- μ Triode	7V	H	6.3	0.3	5.0	5.0	3.8	1.4	Triode Unit as Class A Amplifier	100	-1.5	--	87 500	800	70	--	--
6R6-G	Remote Cutoff R.F. Pentode	6AW	H	6.3	0.3	4.8	4.8	3.8	2.4	Triode Unit as Class A Amplifier	250	-3.0	1.1	58 000	1200	70	--	--
6R7(GT)(G)	Electron-Ray Tube	6R	H	6.3	0.3	3.8	3.8	3.8	2.4	Triode Unit as Class A Amplifier	300	-9.0	9.5	8500	1900	16	--	--
6S6-GT	Remote Cutoff Pentode	5AK	H	6.3	0.45	3.8	3.8	3.8	2.4	Triode Unit as Class A Amplifier	250	-3.0	1.7	800 000	1450	--	--	--
6S7(G)	Triple-Grid Amplifier	7R	H	6.3	0.15	6.5	6.5	6.5	2.4	Triode Unit as Class A Amplifier	135	-3.0	--	--	--	--	--	--
6SA7(GT)(G)	Pentagrid Converter	8R	H	6.3	0.3	9.5	9.5	12	1.4	Class A Amplifier	100	--	75	500 000	1000 000	32	Gain per stage = 32	--
6SB7Y	Pentagrid Converter	8R	H	6.3	0.3	9.6	9.6	9.2	1.4	Class A Amplifier	100	-1	100	500 000	950	--	--	--
6SC7	Twin-Triode Amplifier	8S	H	6.3	0.3	2.2	3.0	3.0	2.0	Class A Amplifier	250	-2.0	--	53 000	1325	70	--	--
6SD7-GT	R.F. Amplifier Pentode	8K	H	6.3	0.3	9.0	9.0	7.5	0.0085	Class A Amplifier	250	-2.0	1.9	1000 000	3600	--	--	--
6SE7-GT	R.F. Amplifier Pentode	8K	H	6.3	0.3	8.0	8.0	7.5	0.005	Class A Amplifier	250	-1.5	1.5	1000 000	3100	--	--	--
6SF5(GT)	High- μ Triode	6AB	H	6.3	0.3	4.0	4.0	3.6	2.4	Class A Amplifier	100	-1.0	--	85 000	1150	100	--	--
6SF7	Diode Super-Control Pentode	7AZ	H	6.3	0.3	5.5	5.5	6.0	0.004	Class A Amplifier	250	-1.0	3.4	200 000	1975	--	--	--
6SG7(GT)	H.F. Amplifier Pentode	88K	H	6.3	0.3	8.5	8.5	7.0	0.003	Class A Amplifier	100	-1.0	3.3	250 000	4100	--	--	--
6SH7(GT)	H.F. Amplifier Pentode	88K	H	6.3	0.3	8.5	8.5	7.0	0.003	Class A Amplifier	100	-1.0	3.4	350 000	4000	--	--	--
6SJ7(GT)	Triple-Grid Detector Amplifier	8N	H	6.3	0.3	3.4	3.4	3.0	2.8	Class A Amplifier	100	-3.0	0.9	700 000	1575	--	--	--
						11	11	11	2.8	Class A Amplifier	250	-3.0	0.8	1500 000	1650	--	--	--
						6.0	6.0	6.0	0.005	Class A Amplifier	300	-3.0	0.8	1500 000	1650	--	--	--

For other characteristics, refer to type 6X6(G)

TYPE	DESIGN	BASE	CATHODE TYPE & RATING		INTERELECTRODE CAPACITANCES			USED AS	PLATE SUPPLY (VOLTS)	GRID BIAS (VOLTS)	SCREEN SUPPLY (VOLTS)	SCREEN CURRENT (MA.)	PLATE CURRENT (MA.)	R.P. PLATE A.C. RESISTANCE (OHMS)	GM TRANS-CONDUCTANCE (UMHOS)	JJ AMPLIFICATION FACTOR	LOAD FOR STATED POWER OUTPUT (OHMS)	POWER OUTPUT (WATTS)
			F = FILAMENT H = HEATER	TYPE	VOLTS	AMP.	IN. (P.P.M.)											
6SK7(GT)(G)	Triode-Grid Amplifier	8N	H	6.3	0.3	6.0	7.0	0.003	100	-1.0	100	4.0	13.0	120 000	2350	--	--	
6SL7-GT	Twin-Triode Amplifier	8BD	H	6.3	0.3	3.0	3.8	2.8	250	-2.0	--	--	2.3	44 000	1600	70	--	
6SN7-GT	Twin-Triode Amplifier	8BD	H	6.3	0.6	2.8	0.8	3.8	90 250	0 -8.0	--	--	10.0 9.0	6700 7700	3000 2600	20 20	--	
6SQ7(GT)(G)	Duplex-Diode High-Mu Triode	8Q	H	6.3	0.3	3.2	3.0	1.6	250	-2.0	--	--	0.9	91 000	1100	100	--	
6SR7	Duplex-Diode Triode	8Q	H	6.3	0.3	3.6	2.8	2.4	90 300	Cathode Bias, 11000 OHMS Cathode Bias, 3900 OHMS	--	--	9.5	8500	1900	16	10 000	
6SS7	Triple-Grid Super-Control Amplifier	8N	H	6.3	0.15	5.5	7.0	0.004	100	-1.0	100	3.1	12.2	120 000	1930	--	--	
6ST7	Duplex-Diode Triode	8Q	H	6.3	0.15	2.8	3.0	1.5	250	-3.0	--	--	3.0	1000 000	1850	--	--	
6S7Z	Duplex-Diode Triode	8Q	H	6.3	0.15	2.6	2.8	1.1	250	-3	--	--	1	58 700	1200	70	--	
6T5	Electron-Ray Tube	6R	H	6.3	0.3				250	Cut-off Bias = 12 V	--	--	0.24	Target current 4 MA			--	
6T69M	R.F. Amplifier Pentode	6Z	H	6.3	0.45				250	-1.0	100	2.0	10.0	1000 000	5500	--	--	
6T7-G	Duplex-Diode High-Mu Triode	7V	H	6.3	0.15	1.8	3.1	1.7	90 300	-3.0	--	--	1.2	62 000	1050	65	--	
6U5	Electron-Ray Tube	6R	H	6.3	0.3				250	Cathode Bias, 8000 OHMS Cathode Bias, 4560 OHMS	--	--	0.24	Target current 4 MA			--	
6U6-GT	Beam Power Amplifier	7AC	H	6.3	0.75				200	-14.0	135	3.0	56.0	20 000	6200	--	3000	
6U7-G	Triple-Grid Super-Control Amplifier	7R	H	6.3	0.3	5	9	0.007	100	-3.0	100	2.2	8.0	250 000	1500	--	--	
6V6(GT)(G)	Beam Power Amplifier	7AC	H	6.3	0.45	10	11	0.03	100	-10.0	100	2.0	8.2	800 000	1600	--	--	
6V7-G	Duplex-Diode Triode	7V	H	6.3	0.3	2.0	3.5	1.7	250	-10.0	100	--	--	Oscillator peak volts = 7.0				
6W5(G)	Full-wave Rectifier	6S	H	6.3	0.9				180	-8.5	180	3.0	29.0	58 000	3700	--	5500	
6W6-GT	Beam Power Amplifier	7AC	H	6.3	1.25				315	-13.5	225	2.2	34.0	77 000	3750	--	8500	
6W7-G	Triple-Grid Detector Amplifier	7R	H	6.3	0.15	5	8.5	0.007	250	-15.0	250	5.0	70.0	--	--	--	10000	
6X4	Full-wave Rectifier	Fig. 1	H	6.3	0.6				300	-20.0	300	5.0	78.0	--	--	--	8000	

Gain per stage = 40
Gain per stage = 15

Plate & Target Supply = 100 volts. Triode Plate Resistor = 0.5 Meg. Target current = 1.0 MA.
Grid Bias, -8 volts; shadow angle, 0°; Bias, 0 volts; angle, 90°; Plate Current, 0.19 MA
Plate & Target Supply = 250 volts, Triode Plate Resistor = 1 Meg. Target current = 4.0 MA.
Grid Bias, -22 volts; shadow angle, 0°; Bias, 0 volts; angle, 90°; Plate Current, 0.24 MA.

For other characteristics, refer to type 6SR7

For other characteristics, refer to type 6S

Maximum A.C. volts per plate (RMS), 325. Maximum D.C. Output MA., 90
Maximum A.C. volts per plate (RMS), 450. Max. D.C. Output MA., 90. Volt Drop at 90 MA., 24 volts

Characteristics same as 6X5 except for miniature base

TYPE	DESIGN	BASE	CATHODE TYPE & RATING		INTERELECTRODE CAPACITANCES		USED AS	PLATE SUPPLY (VOLTS)	GRID BIAS (VOLTS)	SCREEN SUPPLY (VOLTS)	SCREEN CURRENT (MA.)	PLATE CURRENT (MA.)	R.P. AC. PLATE RESISTANCE (OHMS)	G.M. TRANS-CONDUCTANCE (UMHOS)	JJ AMPLIFICATION FACTOR	LOAD FOR STATED POWER OUTPUT (OHMS)	POWER OUTPUT (WATTS)		
			F = FILAMENT H = HEATER	TYPE	VOLTS	AMP.												IN. (G-GK)	OUT. (CPK)/PLATE (UMUF)
7C7	Triode-Grid Detector Amplifier	8V	H	6.3	0.15	5.5	6.5	0.007	Class A Amplifier	100 250	-3.0 -3.0	0.4 0.5	1.8 2.0	1 200 000 2 000 000	1225 1300	--	--		
7D7	Triode-Hexode Converter	8AR	H	6.3	0.43				Oscillator Mixer	150 250	-3.0 -3.0	Values for Triode Unit Values for Hexode Unit	3.5 --	16 800 --	1900 --	32 --	Convers. Transcond. 275 Microhmhos		
7E5	URF Triode	88K	H	6.3	0.15	3.6	2.8	1.5	Class A Amplifier	180	-3.0	--	5.5	120,000	--	--	--		
7E6	Duplex-Diode Triode	8W	H	6.3	0.3				Triode Unit as Class A Amplifier	For other characteristics, refer to type 6B7								--	--
7E7	Duplex-Diode Pentode	8AE	H	6.3	0.3	4.6	4.6	0.005	Pentode Unit as Class A Amplifier	100 250	-1.0 -3.0	2.7 1.6	10.0 7.5	150 000 700 000	1600 1300	--	--		
7F7	Twin-Triode Amplifier	8AC	H	6.3	0.3				Each Unit as Amplifier	For other characteristics, refer to type 6SL7-07								--	--
7F8	Twin Triode Amplifier	88W	H	6.3	0.3	2.8	1.4	1.2	R.F. Amplifier	180 250	-1.0 -2.5	--	12.0 10.0	8500 10 400	7000 5000	--	--		
7G7/1232	Triode-Grid Amplifier	8V	H	6.3	0.45	9.0	7.0	0.007	Class A Amplifier	250	-2.0	2.0	6.0	800 000	9500	--	--		
7G8	Dual Tetrode	88V	H	6.3	0.3	3.4	2.6	0.15	Each Unit as Class A Amplifier	250	-2.5	0.8	4.5	225 000	2100	--	--		
7H7	Triode-Grid Super-Control Amplifier	8V	H	6.3	0.3	8.0	7.0	0.007	Class A Amplifier	100 250	-1.0 -2.5	3.3 3.5	8.2 9.5	250 000 800 000	3800 3800	--	--		
7J7	Triode-Heptode Converter	8AR	H	6.3	0.3	5.5	7.5	1.0	Triode Unit as Oscillator Mixer	100 250	-3.0 -3.0	3.1 2.9	1.1 1.3	300 000 1500 000	Conversion Transcond., 260 Microhmhos Conversion Transcond., 300 Microhmhos	--	--		
7K7	Duplex-Diode Right-Wu Triode	88F	H	6.3	0.3	2.4	2.0	1.7	Triode Unit as Class A Amplifier	250	-2.0	--	2.3	44 000	1600	70	--		
7L7	Triode-Grid Amplifier	8V	H	6.3	0.3	8.0	6.5	0.01	Class A Amplifier	100 250	-1.0 -1.5	2.4 1.5	5.5 4.5	100 000 1000 000	3000 3100	--	--		
7N7	Twin Triode Amplifier	8AC	H	6.3	0.6	3.4	2.0	3.0	Each Unit as Amplifier	250	-8.0	--	9.0	7700	2600	20	--		
7Q7	Pentagrid Converter	8AL	H	6.3	0.3	9.0	9.0	0.20	Converter	For other characteristics, refer to type 6SA7								--	--
7R7	Duplex-Diode Pentode	8AE	H	6.3	0.3	5.6	5.3	0.004	Pentode Unit as Amplifier	250	-1.0	2.1	5.7	1000 000	3200	--	--		
7S7	Triode-Hexode Converter	88L	H	6.3	0.3	5.0	8.0	0.03	Oscillator Mixer	250 250	Triode Unit Hex. Unit	-- 2.2	5.0 1.7	-- 2000 000	Triode Grid Current, 0.4 MA., Resistor 50000 Conver. Transcon., 600 URMOS (E _{CG} = 2V.)	--	--		
7T7	Triode-Grid Amplifier	8V	H	6.3	0.3				Class A Amplifier	250	-1.0	4.1	10.8	900 000	4900	--	--		
7V7	R.F. Amplifier Pentode	8V	H	6.3	0.45	9.5	6.5	0.004	Class A Amplifier	300	-2.0	3.9	9.6	300 000	5800	--	--		
7W7	R.F. Amplifier Pentode	88J	H	6.3	0.45	9.5	7.0	0.0025	Extended Cutoff Class A Amplifier	300	-2.0	3.9	10.0	300 000	5800	--	--		
7X7	Duplex-Diode Triode	88Z	H	6.3	0.3				Class A Amplifier	250	-1	--	1.9	85 000	1500	100	--		
7Y4	Full-wave Rectifier	54B	H	6.3	0.5				With Condenser Input Filter	Max. A.C. Volts per plate (RMS), 325 Max. Peak Inverse Volts, 1250								Min. Total Effective Supply Impedance per plate, 150 Ω	--
7Z4	Full-wave Rectifier	54B	H	6.3	0.5				With Choke Input Filter	Max. A.C. Volts per plate (RMS), 450 Max. Peak Inverse Volts, 1250								Min. Total effective supply Impedance per plate, 75 Ω	--
									With Choke Input Filter	Max. A.C. Volts per plate, (RMS), 450 Max. Peak Inverse Volts, 1250								Minimum value of input Choke, 6 Henries	--

10	Power Amplifier Triode	4D	F	7.5	1.25	4.0	3.0	7.0	Class A Amplifier	350 425	-32.0 -40.0	--	16.0 18.0	5150 5000	1550 1600	8.0 8.0	11 000 102 000	0.9 1.6			
11	Detector Amplifier Triode	4F	D.C. F	1.1	0.25	2.5	2.5	3.3	Class A Amplifier	90 135	-4.5 -10.5	--	2.5 3.0	15 500 15 000	425 440	6.6 6.6	--	--			
12A5	Power Amplifier Pentode	7F	H	6.3 12.6	0.6 0.3	9.0	9.0	0.3	Class A Amplifier	100 180	-15.0 -23.0	100 180	3.0 8.0	50 000 35 000	1700 2400	--	4500 3300	0.8 3.4			
12A6	Beam Power Amplifier	7AC	H	12.6	0.15	9.0	9.0	0.3	Class A Amplifier	250	-12.5	250	3.5	70 000	3000	--	7500	2.8			
12A7	Duplex-Diode Triode	7BT	H	12.6	0.15				Class A Amplifier	For other characteristics, refer to 6A7G											
12A7	Rectifier Pentode	7K	H	12.6	0.3				Pentode Unit as Class A Amplifier Half-Wave Rectifier	135	-13.5	135	2.5	102 000	975	--	13 500	0.55			
12A7-6T	Twin Triode Amplifier	8BE	H	12.6	0.15	2.8	2.6	3.0	Each Unit as Class A Amplifier	250	-9.0	--	--	6600	2400	16	--	--			
12A8-6T/G	Pentagrid Converter	8A	H	12.6	0.15				Converter	For other characteristics, refer to type 6A8											
12B6M 33	Diode Triode	6Y	H	12.6	0.15				Class A Amplifier	250	-2.0	--	0.9	91 000	1100	100	--	--			
12BA6	R.F. Amplifier Pentode	7BK	H	12.6	0.15				R.F. Amplifier	For other characteristics, refer to 6BA6											
12BE6	Pentagrid Converter	7CH	H	12.6	0.15				Converter	For other characteristics, refer to 6BE6											
12B7	Triple-Grid Super-Control Amplifier	8V	H	12.6	0.15	6.0	7.0	0.005	Class A Amplifier	For other characteristics, refer to type 14A7											
12B8-6T	Triode Pentode	8T	H	12.6	0.3	5.0	6.3	2.3	Triode Unit as Class A Amplifier Pentode Unit as Class A Amplifier	90 100	0 -1.0	--	2.8 0.6	37 000 73 000	2400 1500	90 110	--	--			
12C8	Duplex-Diode Pentode	8E	H	12.6	0.15				Pentode Unit as R.F. Amplifier Pentode Unit as A.F. Amplifier	250	-3.0	125	2.3	60 000	1325	--	--	--			
12E5-6T/G	Amplifier Triode	6Q	H	12.6	0.15				Class A Amplifier	250	-13.5	--	5.0	9500	1450	13.8	--	--			
12F5-6T	High- μ Triode	5M	H	12.6	0.15				Class A Amplifier	For other characteristics, refer to type 6F5											
12G7-G	Duplex-Diode High- μ Triode	7V	H	12.6	0.15				Triode Unit as Class A Amplifier	250	-3.0	--	--	58 000	1200	70	--	--			
12H6	Twin Diode	7Q	H	12.6	0.15				Detector Rectifier	For other characteristics, refer to type 6H6											
12J5(GT)	Detector Amplifier Triode	6Q	H	12.6	0.15				Amplifier	For other characteristics, refer to type 6J5											
12J7(GT/G)	Triple-Grid Detector Amplifier	7R	H	12.6	0.15				Amplifier	For other characteristics, refer to type 6J7											
12K7(GT/G)	Triple-Grid Super-Control Amplifier	7R	H	12.6	0.15				Amplifier	For other characteristics, refer to type 6K7											
12L8(GT)	Triode-Hexode Converter	8K	H	12.6	0.15				Oscillator Mixer	For other characteristics, refer to type 6L8											
12L8-6T	Twin Pentode	8BU	H	12.6	0.15	5.0	6.0	0.7	Each Unit as Class A Amplifier	180	9.0	180	2.8	160 000	2150	--	10 000	1.0			
12O7-6T/G	Duplex-Diode High- μ Triode	7V	H	12.6	0.15				Triode Unit as Amplifier	For other characteristics, refer to type 6O7											
12SA7(GT)(G)	Pentagrid Converter	8R 8AD	H	12.6	0.15				Mixer	For other characteristics, refer to type 6SA7											

TYPE	DESIGN	BASE	CATHODE TYPE & RATING		INTERELECTRODE CAPACITANCES		USED AS	PLATE SUPPLY (VOLTS)	GRID BIAS (VOLTS)	SCREEN SUPPLY (VOLTS)	SCREEN CURRENT (MA.)	PLATE CURRENT (MA.)	R.P. A.C. PLATE RESISTANCE (OHMS)	GM TRANS CONDUCTANCE (UMHOS)	M.U. AMPLIFICATION FACTOR	LOAD FOR STATED POWER OUTPUT (OHMS)	POWER OUTPUT (WATTS)
			F = FILAMENT H = HEATER	TYPE VOLTS AMP.	IN. (UMF)	OUT. (Cpk)											
128C7	Twin-Triode Amplifier	8S	H	12.6 0.15			Amplifier										
128F5(8T)	High-Mu Triode	6A8	H	12.6 0.15			Amplifier										
128F7	Diode Super-control Amp.	7A2	H	12.6 0.15			Pentode Unit as Class A Amplifier										
129G7	R.F. Amplifier Pentode	88K	H	12.6 0.15			Class A Amplifier										
129H7(8T)	H.F. Amplifier Pentode	88K	H	12.6 0.15			Class A Amplifier										
129J7(8T)	Triple-Grid Detector Amplifier	8K	H	12.6 0.15			Class A Amplifier										
129K7(8T)(G)	Triple-Grid Super-Control Amplifier	8K	H	12.6 0.15			Class A Amplifier										
129L7-8T	Twin-Triode Amplifier	88D	H	12.6 0.15			Each Unit as Class A Amplifier										
129M7-8T	Twin-Triode Amplifier	88D	H	12.6 0.3			Each Unit as Class A Amplifier										
129N7(8T)(G)	Duplex-Diode High-Mu Triode	80	H	12.6 0.15			Triode Unit as Class A Amplifier										
129R7	Duplex-Diode Triode	80	H	12.6 0.15			Triode Unit as Class A Amplifier										
129S7	Duplex-Diode Triode	80	H	12.6 0.15	3.0	2.8	2.4	250	-9.0	--	--	9.5	--	1900	16	--	--
129X7-8T	Twin-Triode Amplifier	88D	H	12.6 0.3	3.0	0.8	3.6	250	-8.0	--	--	9.0	--	2600	20.5	--	--
129Y7	Pentagrid Converter	8A0	H	12.6 0.15	9.5	12.0	0.06	250	-2.0	100	9.0	3.5	--	Oscillator-Grid (H-1) Resistor, 20 000Ω Conversion Transcond., 450 Micromhos			
1223	Half-Wave Rectifier	4G	H	12.6 0.3				Max. A.C. Plate volts (RMS), 235 Max. D.C. Output MA., 55									
1225	Rectifier-Doubler	7L	H	6.3 0.6 12.6 0.3				Maximum A.C. voltage per plate (RMS), 225 Maximum D.C. Output current per plate, 60 MA									
14A4	Detector Amplifier Triode	5A4	H	12.6 0.15				For other characteristics, refer to type 6A5									
14A5	Beam Power Amplifier	6AA	H	12.6 0.15	6.8	7.0	0.4	250	-12.5	250	3.5	30.0	50 000	3000	--	7500	2.5
14A7	Triple-Grid Super-Control Amplifier	8V	H	12.6 0.15	6.0	7.0	0.005	100 250	-1.0 -3.0	100 100	4.0 2.6	13.0 9.2	120 000 800 000	2350 2000	--	--	--
14A77	Twin Triode	8AC	H	12.6 0.15				250	-10.0	--	--	9.0	7600	2100	16	--	--
1486	Duplex-Diode High-Mu Triode	8W	H	12.6 0.15				For other characteristics, refer to type 68Q7									
1488	Pentagrid Converter	8X	H	12.6 0.15				For other characteristics, refer to type 6A8									
14C5	Beam Power Amplifier	6AA	H	12.6 0.225				For other characteristics, refer to type 6V8									
14C7	R.F. Amplifier Pentode	8V	H	12.6 0.15	6.0	6.5	0.007	250	-3.0	100	0.7	2.2	1000 000	1575	--	--	--
14E6	Duplex-Diode Triode	8W	H	12.6 0.15				For other characteristics, refer to type 6R7									

Tube Type	Application	Grids	Plate	Control	Screen	Rectifier	Diode	Other	Notes
14E7	Duplex-Diode Pentode	8AE	H	12.6	0.15				Pentode Unit as Class A Amplifier
14F7	Twin-Triode Amplifier	8AC	H	12.6	0.15				For other characteristics, refer to type 7E7
14H7	Triple-Grid Super-Control Amplifier	8V	H	12.6	0.15				For other characteristics, refer to type 68L7-0T
14J7	Triode-Rectode Converter	88L	H	12.6	0.15				For other characteristics, refer to type 7H7
14K7	Twin-Triode Amplifier	8AC	H	12.6	0.3				For other characteristics, refer to type 7J7
14Q7	Pentagrid Converter	8AL	H	12.6	0.15				For other characteristics, refer to type 7N7
14R7	Duplex-Diode Pentode	8AE	H	12.6	0.15				For other characteristics, refer to type 68A7
14S7	Triode-Rectode Converter	88L	H	12.6	0.15				For other characteristics, refer to type 7R7
14V7	R.F. Amplifier Pentode	8V	H	12.6	0.225				For other characteristics, refer to type 7S7
14W7	R.F. Amplifier Pentode	88J	H	12.6	0.225				For other characteristics, refer to type 7V7
14Y4	Full-Wave Rectifier	5AB	H	12.6	0.3				For other characteristics, refer to type 7W7
14Z3	Half-Wave Rectifier	4G	H	12.6	0.3				Max. A.C. volts per plate (RMS), 325 Max. Peak Inverse Volts, 1250 Min. Total Effective Supply Impedance, 150 OHMS Minimum value of input Choke, 10 Henries
RK-15	Triode power 4D with No. 3 Blank, Grid Cap			2.5	1.75				For other characteristics, refer to type 12Z3
15	R.F. Amplifier Pentode	5F	D.C. F	2.0	0.22	2.35	7.8	0.01	Characteristics same as type 46 with Class B Connections
RK-16	Triode-Power Amplifier	5A	H	2.5	2.0				67.5 -1.5 67.5 0.3 1.85 630 000 710 450 135 -1.5 67.5 0.3 1.85 800 000 750 600
RK-17	Pentode Power Amplifier	5F	H	2.5	2.0				Characteristics same as type 59 with Class A Triode Connections
18	Power Amplifier Pentode	6B	H	14.0	0.3				For other characteristics, refer to type 2M5
19	Twin-Triode Amplifier	6C	D.C. F	2.0	0.26				For other characteristics, refer to type 2M6
20	Power Amplifier Triode	4D	D.C. F	3.3	0.132	2.0	2.3	4.1	For other characteristics, refer to type 1J6-0
20J8 (GM)	Triode-Rectode Converter	8H	H	20.0	0.15				For other characteristics, refer to type 6J8-0
21A7	Triode-Rectode Converter	8AR	H	21.0	0.16				For other characteristics, refer to type 6J8-0
22	R.F. Amplifier Tetrode	4K	D.C. F	3.3	0.132	3.5	10.0	0.02	For other characteristics, refer to type 6J8-0
RK-24	Triode Amplifier Oscillator	4D	D.C. F	2.0	0.12				For other characteristics, refer to type 6J8-0
24-A 24-S	R.F. Amplifier Tetrode	5E	H	2.5	1.75	5.3	10.5	0.007	For other characteristics, refer to type 6J8-0
25A6(GT)(G)	Power Amplifier Pentode	7S	H	25.0	0.3	8.5	12.5	0.2	For other characteristics, refer to type 6J8-0

TYPE	DESIGN	BASE	CATHODE TYPE & RATING		INTERELECTRODE CAPACITANCES (pF)		USED AS	PLATE SUPPLY (VOLTS)	GRID BIAS (VOLTS)	SCREEN SUPPLY (VOLTS)	SCREEN CURRENT (MA.)	PLATE CURRENT (MA.)	RP A.C. PLATE RESISTANCE (OHMS)	GM TRANS-CONDUCTANCE (μMHOS)	JJ AMPLIFICATION FACTOR	LOAD FOR STATED POWER OUTPUT (OHMS)	POWER OUTPUT (WATTS)
			F FILAMENT H HEATER	TYPE VOLTS AMP.	IN. (CGK)	OUT. (CPK) PLATE											
25A7-GT/G	Rectifier Pentode	8F	H	25.0 0.3			Pentode Unit as Class A Amplifier Half-Wave Rectifier	100	-15.0	100	4.0	20.5	50 000	1800	--	4500	0.77
25AC5-GT/G	High-Mu Power Amplifier Triode	6Q	H	25.0 0.3			Class B Amplifier Dynamic-Coupled Amp. with Type 6AS5-OT Driver	180	0	--	--	4.0 (3)	--	--	--	4800	6.0
25B5	Direct-Coupled Triodes	6D	H	25.0 0.3			Class A Amplifier	In. Plate 100	0	180	4.6	5.8	--	--	--	4000	3.8
25B6-G	Power Amplifier Pentode	7S	H	25.0 0.3			Class A Amplifier	105	-16.0	105	2.0	48.0	15 500	4800	--	1700	2.4
25B8-GT	Triode Pentode	8T	H	25.0 0.15	5.0 (3)	4.6 (3)		200	-23.0	135	1.8	62.0	18 000	5000	--	2500	7.1
25C6-G	Beam Power Amplifier	7AC	H	25.0 0.3				For other characteristics, refer to type 12B6-OT									
25D8-GT	Diode-Triode Pentode	8AF	H	25.0 0.15				For other characteristics refer to type 6Y6D									
25L6(GT)(G)	Beam Power Amplifier	7AC	H	25.0 0.3	16.0	13.5	Amplifier	For other characteristics, refer to type 60L60T									
25N6(G)	Direct-Coupled Triodes	7W	H	25.0 0.3			Amplifier	For other characteristics, refer to type 20B5									
25S/1B5	Duplex-Diode Triode	6M	D.C. F	2.0 0.06			Triode Unit as Amplifier	For other characteristics, refer to type 1B5/25S									
25X6-GT	Full-Wave Rectifier	7Q	H	25.0 0.15			Rectifier	Maximum A.C. volts per plate (RMS), 125 Maximum D.C. output current, 75 MA.									
25Y4(GT)	Half-Wave Rectifier	5AA	H	25.0 0.15			Rectifier	Maximum A.C. volts per plate (RMS), 125 Maximum D.C. output current, 75 MA.									
25Y5	Rectifier Doubler	6E	H	25.0 0.3			Rectifier	Maximum A.C. volts per plate (RMS), 250 Maximum D.C. output current, 85 MA.									
25Z3	Half-Wave Rectifier	4Q	H	25.0 0.3			Rectifier	Maximum A.C. volts per plate (RMS), 280 Maximum D.C. output current, 50 MA.									
25Z4(GT)	Half-Wave Rectifier	5AA	H	25.0 0.3			Rectifier	Maximum A.C. volts per plate (RMS), 125 Maximum D.C. output current, 125 MA.									
25Z5	Rectifier Doubler	6E	H	25.0 0.3			Rectifier Doubler	For other characteristics, refer to type 20Z6									
25Z6(GT)(8)	Rectifier Doubler	7Q	H	25.0 0.3			Voltage Doubler	Max. A.C. volts per plate RMS, 117 Max. D.C. output MA., 175 Minimum total effective plate supply impedance: Half-wave, 30 OHMS; Full-Wave, 0 OHMS									
26	Amplifier Triode	4D	F	1.5 1.05	2.8	2.5	Class A Amplifier	90	-7.0	--	--	2.9	8900	935	8.3	--	--
26A6	R.F. Amplifier Pentode	78K	H	26.5 0.07			R.F. Amplifier	180	-14.5	100	4	10.5	7300	1150	8.3	--	--
26A7-GT	Twin Pentode Amplifier	88U	H	26.5 0.6	13.0	1.2	Each Unit as Class A Amplifier	250	-4.5	26.5	4.0	20.0	--	5000	--	1500	0.15
26C6	Duplex-Diode Triode	78T	H	26.5 0.07			Class A Amplifier	250	-9	--	--	9.5	8500	1900	16	--	--
26D6	Pentagrid Converter	7CH	H	26.5 0.07			Converter	100	-1.5	100	8	2.8	500 000	455	--	--	--
			H	26.5 0.07				250	-1.5	100	7.8	3	1000 000	475	--	--	--

27	Detector Amplifier Triode	5A	H	2.5	1.75	3.1	2.3	3.3	Class A Amplifier	135 250 250	-9.0 -21.0 -30.0 Approx.	-- -- --	-- -- --	4.5 5.2	9000 9250	1000 975	9.0 9.0	-- --	
28D7	Twin Beam Power Amplifier	88S	H	28.0	0.4				Bias Detector	28	-3.5	28	1.0	12.5	3000	3000	--	4000	0.1
28Z5	Full-Wave Rectifier	68J	H	28	0.24				Class A Amplifier	135 180	-22.5 -30.0	--	--	8.0 12.3	4100 3600	925 1050	3.8 3.8	7000 5700	0.185 0.375
30	Detector Amplifier Triode	4D	D.C. F	2.0	0.06				Amplifier	For other characteristics, refer to type 1H4G									
31	Power Amplifier Triode	4D	D.C. F	2.0	0.13	3.5	2.7	5.7	Class A Amplifier	135 180	-3.0 -3.0 -6.0 Approx.	67.5 67.5 67.5	--	--	4100 3600	925 1050	3.8 3.8	7000 5700	0.185 0.375
32	R.F. Amplifier Tetrode	4K	D.C. F	2.0	0.06	5.3	10.5	0.015	Screen-Grid R.F. Amplifier Bias Detector	180 (R)	-3.0 -3.0 -6.0 Approx.	67.5 67.5 67.5	--	--	Plate current adjusted to 0.2 MA. with no signal				
32L7-GT	Rectifier-Beam Power Amplifier	8Z	H	32.5	0.3				H.W. Rectifier Class A Amplifier	110 110	-7.5	110	3.0	40.0	15000	6000	--	2500	1.5
33	Power Amplifier Pentode	5K	D.C. F	2.0	0.26	8.0	12.0	1.0	Class A Amplifier	180	-18.0	180	5.0	22.0	55000	1700	--	6000	1.4
34	Super-Control R.F. Amplifier Pentode	4M	D.C. F	2.0	0.06	6.0	11.5	0.015	R.F. Amplifier	135 180	-3.0 Min.	67.5 67.5	1.0 1.0	2.8 2.8	600 000 1000 000	360 620	--	--	--
35/51	Super-Control R.F. Amplifier Tetrode	5E	H	2.5	1.75	5.3	10.5	0.007	Screen-Grid R.F. Amplifier	180 250	-3.0 Min.	90.0 90.0	2.5 2.5 (23)	6.3 6.5	300 000 400 000	1020 1050	305 420	--	--
35A5	Beam Power Amplifier	6AA	H	35.0	0.15				Class A Amplifier	110	-7.5	110	3.0	40.0	14 000	5800	--	2500	1.5
35L6-GT/G	Beam Power Amplifier	7AC	H	35.0	0.15	13	9.5	0.8	Class A Amplifier	For other characteristics, refer to type 35A5									
35W4	Half-Wave Rectifier (Tap for Pilot)	58Q	H	35	0.15				Without pilot	Max. Plate Volts, 235 Max. D. C. Output MA, 100 Max. Plate Volts, 235 Max. D. C. Output MA, 60									
35Y4	Half-Wave Rectifier (Heater tap for pilot)	5AL	H	35.0	0.15				Rectifier	235 Maximum A.C. volts (RMS) 60 MA. Output current with panel lamp 235 Maximum A.C. volts (RMS) 100 MA. Output current without panel lamp									
35Z3(LT)	Half-Wave Rectifier	4Z	H	35.0	0.15				With Condenser Input Filter	Max. A.C. Plate Volts, (RMS) 235 Min. total effective plate supply impedance: up to 117 volts, 15 OHMS; at 150 volts, 40 OHMS; at 235 volts, 100 OHMS Max. D.C. Output MA., 100									
35Z4-GT	Half-Wave Rectifier	5AA	H	35.0	0.15				With Condenser Input Filter	Max. A.C. Plate Volts, (RMS) 250 Maximum Peak Plate MA., 600 Max. Peak Inverse Volts, 720 (26)									
35Z5-GT/G	Half-Wave Rectifier (Heater tap for pilot)	6AD	H	35.0	0.15				With Condenser Input Filter	Max. A.C. Plate Volts (RMS) 235. Minimum total effective plate supply impedance: up to 117 volts, 15 OHMS; at 235 volts, 100 OHMS. Max.D.C.Output MA. with pilot and no shunt resistor, 60; with pilot and shunt resistor, 90; without pilot, 100									
35Z6-G(GT)	Rectifier Doubler	7Q	h	35.0	0.3				Rectifier Doubler	Maximum A.C. volts per plate (RMS), 235 Maximum D.C. output MA., 110									
36	R.F. Amplifier Pentode	5E	H	6.3	0.3	3.7	9.2	0.007	Screen-Grid R.F. Amplifier Bias Detector	100 250 250 (15)	-1.5 -3.0 -5.0 -8.0	55 90 55 90	1.7 (23)	1.8 3.2	550 000 550 000	850 1080	470 595	-- --	
37	Detector Amplifier Triode	5A	H	6.3	0.3	3.5	2.9	2.0	Class A Amplifier Bias Detector	90 250	-6.0 -10.0 -28.0	-- --	--	2.5 7.5	11 5000 11500	800 1100	9.2 9.2	-- --	
38	Power Amplifier Pentode	5F	H	6.3	0.3	3.5	7.5	0.3	Class A Amplifier	100 250	-9.0 -25.0	100 250	1.2 3.8	7.0 22.0	140 000 100 000	875 1200	-- --	15000 10000	0.27 2.50
39/44	Super-Control R.F. Amplifier Pentode	5F	H	6.3	0.3	3.5	10.0	0.007	Class A Amplifier	90 250	-3.0 Min.	90 90	1.6 1.4	5.6 5.8	375 000 1000 000	960 1050	360 1050	-- --	

TYPE	DESIGN	BASE	CATHODE TYPE & RATING		INTERELECTRODE CAPACITANCES (pF)		USED AS	PLATE SUPPLY (VOLTS)	GRID BIAS (VOLTS)	SCREEN SUPPLY (VOLTS)	SCREEN CURRENT (MA.)	PLATE CURRENT (MA.)	R.P. AC-PLATE RESISTANCE (OHMS)	GM TRANS-CONDUCTANCE (UMHOS)	II AMPLIFICATION FACTOR	LOAD FOR STATED POWER OUTPUT (OHMS)	POWER OUTPUT (WATTS)
			F= FILAMENT HEATER	H= HEATER	IN. (CGK)	OUT. (CPK) / GRID-PLATE											
40	Voltage Amplifier Triode	40	D.C.	5.0	0.25	2.8	2.2	8.0	Class A Amplifier	135 180 (17)	--	--	150 000 150 000	200 200	30 30	--	--
40Z5/ 45Z5GT	Half-wave Rectifier (Heater tap for pilot)	6AD	H	45.0	0.15				Rectifier								
41	Power Amplifier Pentode	6B	H	6.3	0.4				Amplifier								
RK42	Triode Amplifier	4D	D.C.	1.5	0.06				Amplifier								
42	Power Amplifier Pentode	6B	H	6.3	0.7				Amplifier								
RK43	Twin-Triode Power Amplifier Oscillator	6C	D.C.	1.5	0.12				Class A Amplifier Class B Amplifier R.F. Amplifier	135 135 135	-- -- --	-- -- --	14 500 -- --	900 -- --	13 -- --	Values for one triode 24000 0.95 (28) 1.25	
43	Power Amplifier Pentode	6B	H	25.0	0.3				Amplifier								
44	Super-Control R.F. Amplifier Pentode	5F	H	6.3	0.3				Class A Amplifier								
45	Power Amplifier Triode	4D	F	2.5	1.5	4.0	3.0	7.0	Class A Amplifier Push-Pull Class A ₂ Amplifier	180 275 275 275	-- -- --	-- -- --	1650 1700	2125 2050	3.5 3.5	2700 4600 5060 3200	0.82 2.0 12.0 11
45Z3	Half-wave Rectifier	5AM	H	45.0	0.075				With Condenser Input Filter								
45Z5-0T	Half-wave Rectifier (Heater tap for pilot)	6AD	H	45.0	0.15				Without Pilot With Pilot								
46	Dual-Grid Power Amplifier	5C	F	2.5	1.75				Class A Amplifier Class B Amplifier	250 300 400	-- -- --	-- -- --	2380 -- --	2350 -- --	5.6 -- --	6400 5200 5800	1.25 16.0 20.0 (11)
47	Power Amplifier Pentode	5B	F	2.5	1.75	8.6	13.0	1.2	Class A Amplifier	250	6.0	31.0	60000	2500	150	7000	2.7
48	Power Amplifier Tetrode	6A	D.C.	30.0	0.4				Tetrode Class A Amplifier Tetrode Push-Pull Class A Amplifier	96 125 125	9.0 9.5	52.0 56.0	-- --	3800 3900	-- --	1500 1500	2.0 2.5
49	Dual-Grid Power Amplifier	5C	D.C.	2.0	0.12				Class A Amplifier Class B Amplifier	135 180	-- --	6.0 4.0 (12)	4175 --	1125 --	4.7 --	11 000 12 000	0.17 3.5 (11)
EF-50	High Frequency Pentode Amplifier	Fig. 8	H	6.3	0.3				R.F. Amplifier	250	3.1	10.0	600 000	6300	--	--	--
50	Power Amplifier Triode	4D	F	7.5	1.25	4.2	3.4	7.1	Class A Amplifier	400 450	--	35.0 55.0	2000 1800	1900 2100	3.8 3.8	4600 4350	1.6 4.6
50A5	Beam Power Amplifier	6AA	H	50.0	0.15				Class A Amplifier	200	1.5	50.0	35 000	8250	--	3000	4.7
50B5	Beam Power Amplifier	7BZ	H	50	0.15	13	6.5	0.5	Class A Amplifier	110	4	50	14 000	7500	--	2500	1.9
50C6-G	Beam Power Amplifier	7AC	H	50.0	0.15				Amplifier								
50L6(6T)	Beam Power Amplifier	7AC	H	50.0	0.15				Class A Amplifier	110 110	4.0 4.0	49.0 49.0	10 000 10 000	8200 8200	-- --	1500 2000	2.1 2.2

TYPE	DESIGN	BASE	CATHODE / TYPE & RATING		INTERELECTRODE CAPACITANCES		USED AS	PLATE SUPPLY (VOLTS)	GRID BIAS (VOLTS)	SCREEN SUPPLY (VOLTS)	SCREEN CURRENT (MA.)	PLATE CURRENT (MA.)	R _p AC. PLATE RESISTANCE (OHMS)	G _m TRANS-CONDUCTANCE (UMHOS)	J _i AMPLIFICATION FACTOR	LOAD FOR STATED POWER OUTPUT (OHMS)	POWER OUTPUT (WATTS)	
			F = FILAMENT H = HEATER TYPE VOLTS AMP.	IN. (CCK)	OUT. (CCK)	GRID-PLATE (CCK)												
77	Triple-Grid Detector Amplifier	6F	H	6.3	0.3	4.7	11.0	0-007	100 250 250	-1.5 -3.0 -1.95	60 100 50	0.4 0.5 Cathode current 0.65 MA.	1.7 2.3	600 000 1250 1000 000+	-- -- plate Resistor, 240 000 OHMS Grid Resistor, 10, 250 000 OHMS	-- -- --	--	
78	Triple-Grid Super-Control Amplifier	6F	H	6.3	0.3	4.5	11.0	0.007	For other characteristics, refer to type 6K7									
79	Twin-Triode Amplifier	6H	H	6.3	0.6				For other characteristics, refer to type 5Y3-07/G									
80	Full-Wave Rectifier	4C	F	5.0	2.0				For other characteristics, refer to type 5Y3-07/G									
81	Half-Wave Rectifier	4B	F	7.5	1.25				Maximum D.C. Output MA., 85 Maximum Peak Plate MA., 800									
82	Full-Wave Rectifier (4)	4C	F	2.5	3.0				Max. A.C. Plate Volts (RMS), 700 Max. Peak Inverse Volts, 2000 Max. A.C. Volts per plate (RMS), 450 Max. Peak Plate MA., 115 Max. Peak Inverse Volts, 1950 Max. Peak Plate MA., 345 Max. A.C. Volts per plate (RMS), 550 Max. Peak Plate MA., 115 Max. Peak Inverse Volts, 1950 Max. Peak Plate MA., 345									
83	Full-Wave Rectifier (1)	4C	F	5.0	3.0				Max. A.C. Volts per plate (RMS), 450 Max. Peak Plate MA., 225 Max. Peak Inverse Volts, 1950 Max. Peak Plate MA., 675 Max. A.C. Volts per plate (RMS), 550 Max. Peak Plate MA., 235 Max. Peak Inverse Volts, 1950 Max. Peak Plate MA., 675									
83-V	Full-Wave Rectifier	4AD	H	5.0	2.0				For other characteristics, refer to type 3V4-0									
8-84	Half-Wave Rectifier	4B	F	2.5	1.5				For other characteristics, refer to type 2Z2/084									
84/624	Full-Wave Rectifier	5D	H	6.3	0.5				Max. A.C. Volts per plate (RMS), 325 Max. Peak Plate MA., 180 Max. Peak Inverse Volts, 1250 Max. A.C. Volts per plate (RMS), 450 Max. Peak Plate MA., 180									
85	Duplex-Diode Triode	66	H	6.3	0.3	1.5	4.3	1.5	135 250	-10.5 -20.0	-- --	-- --	3.7 8.0	11 000 7500	750 1100	8.3 8.3	25 000 20 000	0.075 0.350
85AS (2)	Duplex-Diode Triode	66	H	6.3	0.3				Triode Unit as Class A Amplifier Triode Unit as Class A Amplifier Class A Amplifier As Triode (6) Class A Amplifier As Pentode (5) Class A Amplifier As Triode (7) Class B Amplifier									
89	Triple-Grid Power Amplifier	6F	H	6.3	0.4				160 250 100 250 180									
V-99 99, X-99	Detector Amplifier Triode	4E 4D	D.C. F	3.3	0.063	2.5	2.5	3.3	90	-4.5	--	--	2.5	15 500	425	--	--	--
101D	Detector Amplifier Triode	Fig. 7	D.C. F	4.2	1.0				Class A Amplifier									
101F	Detector Amplifier Triode	Fig. 7	D.C. F	4.0	0.505				Class A Amplifier									
112-A	Detector Amplifier Triode	4D	D.C. F	5.0	0.25	4.0	2.0	8.5	90 180	-4.5 -13.5	-- --	-- --	5.0 7.7	5400 4700	1575 1800	8.5 8.5	5000 10650	0.035 0.285
HY-113/ HY-123	Miniature Triode	PK with screen	D.C. F	1.4	0.07				Oscillator Detector									
HY-114	Triode	Special	D.C. F	1.4	0.12				URF Oscillator Detector Amplifier									

Model	Tube	D.C. F	1.4	0.07						Voltage Amp.	45	-1.5	22.5	0.008	0.03	5 200 000	58	300	--	--	
HY-115	Miniature Pentode	5K	1.4	0.07						Half-wave Rect. Class A Amplifier	105	-5.2	105	4.0	Max. D.C. Output Current, 75 MA.	17 000	5300	--	4000	0.85	
HY-117-6T	Rectifier-Beam Power Amplifier	8A0	117.0	0.09						Half-wave Rect. Class A Amplifier	100	-1.0	100	5.0	Max. D.C. Output Current, 75 MA	16 000	7000	--	3000	1.2	
HY-117-6T	Rectifier-Beam Power Amplifier	8AV	117.0	0.09						Half-wave Rect. Class A Amplifier					For other characteristics, refer to type 117A7-6T/117A7-6T						
HY-117-3	Half-wave Rectifier	48R	117	0.34						Rectifier					Max. A.C. Plate Voltage, 117 Max. Inverse Peak Voltage, 330 Max. D.C. Output MA, 80 Max. Peak MA, 140						
HY-117-4-GT	Half-wave Rectifier	5AA	117.0	0.04						Rectifier					Max. A.C. Plate Voltage (RMS), 117 Max. D.C. Output MA., 90 Max. Peak Plate MA., 450 Min. Total Effective Supply Impedance, 30 OHMS						
HY-117-6-GT/G	Rectifier Doubler	7Q	117.0	0.075						Voltage Doubler					Max. A.C. Plate Voltage (RMS), 117 Max. D.C. Output MA., 40 Min. Total Effective Power Supply Impedance: Half-wave, 30 OHMS; Full-wave, 15 OHMS						
HY-123	Miniature Triode	5K with no screen	1.4	0.07						Oscillator Detector	45	-3.0	45	0.2	0.9	825 000	310	255	50 000	0.0115	
HY-125	Pentode Power Amplifier	5K	1.4	0.07						Class A Amplifier	90	-7.5	90	0.5	2.6	420 000	450	180	28 000	0.050	
HY-145	Miniature Pentode	5K	1.4	0.07						Voltage Amp.					For other characteristics, refer to type HY-115/HT-145						
HY-155	Pentode Power Amplifier	5K	1.4	0.07						Class A Amplifier					For other characteristics, refer to type HY-125/HT-155						
182-8	Triode Amplifier	4D	5.0	1.25						Class A Amplifier	250	-35.0	--	--	18.0	--	1500	5.0	--	--	
183	Power Triode	4D	5.0	1.25						Class A Amplifier	250	-60.0	--	--	25.0	18 000	1800	3.2	4500	2.0	
210T	Triode	4D	7.5	1.25						Class A Amplifier					Characteristics same as type 10 except ceramic base						
HY-245	Pentode Voltage Amp	HY-245	1.25	0.028						Class A Amplifier	45	0	45	0.2	0.4	1000 000	375	--	--	--	
HY-255	Pentode Power Amplifier	HY-245	1.25	0.028						Class A Amplifier	45	-1.5	45	0.35	1.1	--	450	--	--	--	
446A	"Lighthouse" UHF Triode	Fig. 11	6.3	0.75						Oscillator Amplifier Coupled	250	200	--	--	15.0	--	4500	45.0	--	--	
464A	"Lighthouse" UHF Triode	Fig. 9	6.3	0.75						Class A Amplifier	250	100	--	--	25.0	--	7000	--	--	--	
482B	Triode Amplifier	4D	5.0	1.25						Class A Amplifier					For other characteristics, refer to type 182						
483	Power Triode	4D	5.0	1.25						Class A Amplifier					For other characteristics, refer to type 183						
485	Triode	5A	3.0	1.3						Class A Amplifier	180	-8.0	--	--	6.0	8300	1350	12.5	--	--	
CK-501	Miniature Pentode	Tinned Leads	1.25	0.033						Class A Amplifier	30	0	30	0.06	0.3	1000 000	325	--	--	--	
CK-502-AX	Miniature Pentode	Tinned Leads	1.25	0.030						Power Output	45	-1.5	45	0.11	0.45	250 000	500	--	100 000	0.006	
CK-502	Miniature Pentode	Tinned Leads	1.25	0.033						A.F. Output Amplifier	30	0	30	0.06	0.55	500 000	400	--	60 000	0.0035	
CK-502-X	Miniature Pentode	Tinned Leads	1.25	0.033						Power output	45	-1.25	45	0.06	0.6	700 000	500	--	80 000	0.011	
CK-503-AX	Miniature Pentode	Tinned Leads	1.25	0.03						Power output	45	-2.5	45	0.18	0.5	400 000	475	--	50 000	0.010	
CK-503	Miniature Pentode	Tinned Leads	1.25	0.033						A.F. Output Amplifier	30	0	30	0.35	1.5	150 000	600	--	20 000	0.007	
CK-504	Miniature Pentode	Tinned Leads	1.25	0.033						A.F. Output Amplifier	30	0	30	0.09	0.4	500 000	350	--	60 000	0.0045	
CK-505-AX	Miniature Pentode	Tinned Leads	0.625	0.03						Voltage Amplifier	30	0	30	0.07	0.2	500 000	180	Volt. gain 35.		1000 000	--

TYPE	DESIGN	BASE	CATHODE TYPE & RATING		INTERELECTRODE CAPACITANCES		USED AS	PLATE SUPPLY (VOLTS)	GRID BIAS (VOLTS)	SCREEN SUPPLY (VOLTS)	SCREEN CURRENT (MA.)	PLATE CURRENT (MA.)	R.P. A.C. PLATE RESISTANCE (OHMS)	GM TRANS-CONDUCTANCE (MMHOS)	JJ AMPLIFICATION FACTOR	LOAD FOR STATED POWER OUTPUT (OHMS)	POWER OUTPUT (WATTS)
			F FILAMENT	H HEATER	IN. (CGK)	OUT. (CPK)											
CK-505 CK-505-X	Miniature Pentode	Timed Leads	D.C.	0.625 0.03			Imped. Coupled Voltage Amp. Resist. Coupled Voltage Amp.	30 45	0 -1.25	30 40	0.07 0.08	0.17 0.2	1100 000 2000 000	140 150	--	--	--
CK-506-AX	Miniature Pentode	Timed Leads	D.C.	1.25 0.050			Power Output	45	-4.5	45	0.4	1.25	120 000	500	--	30 000	0.025
CK-507-AX	Miniature Pentode	Timed Leads	D.C.	1.25 0.05			Power Output	45	-2.5	45	0.21	0.6	300 000	500	--	50 000	0.012
CK-509-AX	Miniature Triode	Timed Leads	D.C.	0.625 0.030			Voltage Amplifier	45	0	--	--	0.15	150 000	160	Volt. Gain 16	1000 000	--
CK-510-AX	Twin Space Charge Tetrode	Timed Leads	D.C.	0.625 0.50			Each Unit as Class A Amplifier	45	0	45 Thru 0.2 MED.	0.2	0.060	500 000	65	32.5	--	--
559	"Lighthouse" UHF Diode	Fig. 10	H	6.3 0.75	--	2.7	Detector	5.0	--	--	--	24.0	--	--	--	--	--
(RV) 615	Triode	Special	H	6.3 0.15			UHF oscillator Detector Amplifier	50	--	oscillator Grid Current, 3 MA.	--	20	20 000	2200	22.0	--	4.0
(WE) 717A	Pentode	86K	H	6.3 0.175			Class A Amplifier	120	-2.0	120	2.5	7.5	390 000	4000	--	--	--
(GL) 840	R-F. Pentode	5J	D.C. F	2.0 0.13			Class A Amplifier	180	-3.0	67.5	0.7	1.0	1000 000	410	430	--	--
864	Triode Amplifier	4D	D.C. F	1.1 0.25	3.3	2.1	Class A Amplifier	50	-4.5	--	--	2.9	13 500	610	8.2	--	--
950	Power Amplifier Pentode	5X	D.C. F	2.0 0.12			Class A Amplifier	For other characteristics, refer to type 1J5-G									
951	R-F. Amplifier Pentode	4H	D.C. F	2.0 0.06			Amplifier	For other characteristics, refer to type 1J5P									
954	Acorn Pentode Detector Amplifier	58B	H	6.3 0.15	3.4	3.0	Class A Amplifier	90 250	-3.0 -3.0	90 100	0.5 0.7	1.2 2.0	1000 000 1500 000 +	1100 1400	1100 2000 +	--	--
955	Acorn Triode Detector Amplifier Oscillator	58C	H	6.3 0.15	1.0	0.6	Class A Amplifier	60 250	-2.5 -7.0	--	--	2.5 6.3	14 700 11 400	1700 2200	25 25	--	--
956	Acorn Super-Control Pentode	58B	h	6.3 0.15	3.4	3.0	R.F. Amplifier Mixer	250 250	-3.0 -10.0	100 100	2.7 --	6.7 --	700 000 (oscillator Peak Volts)	1800	1400	--	--
957	Acorn Triode Detector Amplifier Oscillator	58D	D.C. F	1.25 0.05	0.7	0.3	Class A Amplifier	135	-5.0	--	--	2.0	24 600	650	16	--	--
958-A	Acorn Triode A.F. Amplifier Oscillator	58D	D.C. F	1.25 0.10	0.6	0.8	Class A Amplifier	135	-7.5	--	--	3.0	10 000	1200	12	--	--
959	Acorn Pentode Detector Amplifier	58E	D.C. F	1.25 0.05	1.8	2.5	Class A Amplifier	135	-3.0	67.5	0.4	1.7	800 000	800	480	--	--
1003/074A	Full-wave Gas Rectifier	4R	Cold	--	--		Rectifier	For other characteristics, refer to type 074A/1013									
CK-1009/BA	Full-wave Rectifier	4J	Cold	--	--		Rectifier	Max. A.C. voltage per plate (RMS), 350 Max. D.C. output current, 350 MA. Tube drop 80V.									
1201	UHF Triode	8BH	H	6.3 0.15			Class A Amplifier	For other characteristics, refer to type 7C5									
1203	UHF Diode	4Ah	H	6.3 0.15			UHF Diode Detector	For other characteristics, refer to type 7C1									

1204	URF Pentode	Fig. 4	H	6.3	0.15														For other characteristics, refer to type 7AB7/1204
1206	Dual Tetrode	88V	H	6.3	0.3														For other characteristics, refer to type 76R
1221 1223	Pentode	6F 7R	H	6.3	0.3														For other characteristics, refer to type 6J7
1229	R.F. Amplifier Tetrode	4K	F	2	0.06														For other characteristics, refer to type 32
1231	Pentode Amplifier	8V	H	6.3	0.45														300 -2.5 150 2.5 10 700 000 5500 3850 -- --
1232	Triple-Grid Amplifier	8V	H	6.3	0.45														For other characteristics, refer to type 707/1232
1276	Power Amplifier Triode	4D	F	4.5	1.14														250 -45 -- -- 60 5250 4.2 2500 3.4
1284	URF Pentode	Fig. 3	H	12.6	0.15														250 -3.0 100 2.5 9.0 800 000 2000 -- --
1291	URF Twin Triode	78E	D.C. F	1.4 2.8	0.22 0.11														For other characteristics, refer to type 6B7/1291
1293	URF Triode	4AA	D.C. F	1.4	0.11														90 0 -- -- 4.7 10 750 1300 14 -- --
1294	URF Diode	4AH	H	1.4	0.15														For other characteristics, refer to type 1R4/1294
1299	Beam Power Amplifier	68B	D.C. F	1.4 2.8	0.22 0.11														For other characteristics, refer to type 3DM/1299
1603	Non-Microphonic Triple-Grid Amplifier	6F	H	6.3	0.3	3.0 (34) 4.6 (35)	7.0	7.0	2.0 (34) 6.5 (35)	10.5 (34) 0.007 (35)									For other characteristics, refer to type 6J7
1609	Pentode Amplifier	5K	D.C. F	1.1	0.25	7.0	7.0	1.0											135 -1.5 67.5 0.65 2.5 400 000 725 300 -- --
1611	Power Amplifier Pentode	7S	H	6.3	0.7														Selected 6F8. For other characteristics, refer to type 6F8
1612	Pentagrid Mixer Amplifier	7T	H	6.3	0.3	7.5	11.0	0.001											Selected 6L7. For other characteristics, refer to type 6L7
1620	Triple-Grid Detector Amplifier	7R	H	6.3	0.3	7.0	12.0	0.005											Selected 6J7. For other characteristics, refer to type 6J7
1621	Power Amplifier Pentode	79	H	6.3	0.7	7.5	11.5	0.20											Selected 6F6. For other characteristics, refer to type 6F6
1622	Beam Power Amplifier	7AC	H	6.3	0.9	10.0	12.0	0.4											Selected 6L4. For other characteristics, refer to type 6L6
1629	Electron-Ray Tube	7AL	H	12.6	0.15														For other characteristics, refer to type 6E5
(6L) 1631	Beam Power Amplifier	7AC	H	12.6	0.45														For other characteristics, refer to type 6L6
(6L) 1632	Beam Power Amplifier	7AC	H	12.6	0.6														For other characteristics, refer to type 25L6
(6L) 1633	Twin Triode	88D	H	25.0	0.15														For other characteristics, refer to type 6SN7-GT
(6L) 1634	Twin Triode Amplifier	89	H	12.6	0.15														Selected 128C7. For other characteristics, refer to type 128C7
1635	Twin Triode Amplifier	88	H	6.3	0.6														300 0 -- -- 54 (12) -- -- 12000 10.4 (11)
1644	Twin Pentode Power Amplifier	88U	H	12.6	0.15														Selected 12L8-GT. For other characteristics, refer to type 12L8-GT
1654	Half-Wave Rectifier	Fig. 2	F	1.4	0.05														Max. A.C. Plate Volts, 2500 Max. Inverse Peak Volts, 7000
1851	Television Amplifier Pentode	7R	H	6.3	0.45	11.5	5.2	0.02											For other characteristics, refer to type 6AC7/1852

TYPE	DESIGN	BASE	CATHODE TYPE & RATING		INTERELECTRODE CAPACITANCES (pF)			USED AS	PLATE SUPPLY (VOLTS)	GRID BIAS (VOLTS)	SCREEN SUPPLY (VOLTS)	SCREEN CURRENT (MA.)	PLATE CURRENT (MA.)	RP A.C. PLATE RESISTANCE (OHMS)	GM TRANS-CONDUCTANCE (μMHOS)	μ AMPLIFICATION FACTOR	LOAD FOR STATED POWER OUTPUT (OHMS)	POWER OUTPUT (WATTS)
			F FILAMENT	H HEATER	IN. (CGK)	OUT. (UUF)	GRID-PLATE (CPK)											
1852	Television Amplifier Pentode	8H	H	6.3	0.45			Class A Amplifier										
1853	Television Amplifier Pentode	8H	H	6.3	0.45			Class A Amplifier										
7000	Low Noise Amplifier	7R	H	6.3	0.3			Class A Amplifier										
7193	Triode Amplifier	4AM	H	6.3	0.3			Class A Amplifier										
7700	Non-Microphonic Triode-Grid Amplifier	6F	H	6.3	0.3			Class A Amplifier										
8016	Half-Wave Rectifier	4Y	F	1.25	0.2			Rectifier										
9001	Triple-Grid Detector Amplifier	78D	H	6.3	0.15	3.6	3.0	0.01	Class A Amplifier Mixer	250	100	0.7	2.0	1000 000 +	1400	--	--	--
9002	Triode Detector Amplifier Oscillator	78S	H	6.3	0.15	1.2	1.1	1.4	Class A Amplifier Mixer	250	--	--	2.5 6.3	14 700 11 400	1700 2200	25 25	--	--
9003	Triode-Grid Super-Control Amplifier	78D	H	6.3	0.15	3.4	3.0	0.01	Class A Amplifier Mixer	250	100	2.7	6.7	700 000	1800	--	--	--
9004	URF Diode	48J	H	6.3	0.15	--	1.3	--	Detector									
9005	URF Diode	58G	H	3.6	0.165	--	0.8	--	Detector									
9006	URF Diode	68H	H	6.3	0.15	--	1.4	--	Detector									

For other characteristics, refer to type 6AC7/1852

For other characteristics, refer to type 6AB7/1853

For other characteristics, refer to type 6J7

Selected 3C22. For other characteristics, refer to type 2C22

For other characteristics, refer to type 6J7

Max. Peak Inverse Voltage 10000 Average Plate Current, 3 MA.

Max. Peak Plate Current, 7.0 MA.

Max. D. C. Output Current, 5 MA.

Max. A.C. Voltage, 117

Max. A.C. Voltage, 117

Max. D. C. Output Current, 1 MA.

Max. A.C. Voltage, 270

Max. D. C. Output Current, 8 MA

CONTROL, REGULATOR AND SPECIAL RECTIFIER TUBES

TYPE	DESIGN	BASE	CATHODE TYPE AND RATING		PURPOSE	MAX. FORWARD ANODE VOLTAGE	MAX. PEAK INVERSE ANODE VOLTAGE	MAX. PEAK ANODE CURRENT (MA.)	OPERATING ANODE VOLTAGE	MAX. OPERATING ANODE CURRENT (MA.)	TUBE VOLTAGE DROP	PRE-HEATING TIME (SECONDS)	MISCELLANEOUS DATA
			TYPE	VOLTS									
0A2	Miniature Gas Voltage Regulator	Fig. 16	Cold	--	Voltage Regulator	--	--	--	150 D.C.	5 Min. 30 Max.	--	--	Minimum D. C. Starting Voltage, 15H
0A3/VR75	Gas Voltage Regulator	4AJ	Cold	--	Voltage Regulator	--	--	--	75 D.C.	5 Min. 40 Max.	--	--	Minimum D.C. Starting Voltage, 10H. Regulation (5 to 10 MA.), 5 Volts
0A4-G	Gas Triode Starter-Anode Type	4V	Cold	--	Relay Service	225 Starter tied to Anode	--	100	105 To 130 RMS	25	--	--	Starter-Anode Bias, 70 Maximum Peak Volts. Sum of Bias and Signal Voltage, 110 Min. Peak Volts
0B3/VR90	Gas Voltage Regulator	4W	Cold	--	Voltage Regulator	--	--	--	90 D.C.	5 Min. 40 Max.	--	--	Minimum D.C. Starting Voltage, 12H. Regulation (5 to 40 MA.), 8 Volts
0C3/VR105	Gas Voltage Regulator	4W	Cold	--	Voltage Regulator	--	--	--	105 D.C.	5 Min. 40 Max.	--	--	Minimum D.C. Starting Voltage, 13H. Regulation (5 to 40 MA.), 2 Volts
0D3/VR150	Gas Voltage Regulator	4W	Cold	--	Voltage Regulator	--	--	--	150 D.C.	5 Min. 40 Max.	--	--	Minimum D.C. Starting Voltage, 18H. Regulation (5 to 40 MA.), 4 Volts
1B47	Gas Voltage Regulator	--	--	--	Voltage Regulator	--	--	--	82	1-2	--	--	Grid Bias, 6H Max. Peak Volts. Sum of Bias & Signal Voltages, 100 Min. Peak Volts
1C21	Gas Triode	4W	Cold	--	Relay Service	180 Grid Tied to Cathode	--	100	125 to 145 D.C.	25	--	--	Grid Bias, 6H Max. Peak Volts. Sum of Bias & Signal Voltages, 100 Min. Peak Volts
1N21B	Silicon Crystal Converter	--	--	--	Converter	Conversion loss 6.5 db. I.F. Maximum Frequency, 3,000 mc.	--	--	Impedance 200-800 ohms	--	--	--	
1N23B	Silicon Crystal Converter	--	--	--	Converter	Conversion loss 6.5 db. I.F. Maximum Frequency, 10,000 mc.	--	--	Impedance 150-600 ohms	--	--	--	
1N25	Silicon Crystal Converter	--	--	--	Converter	Conversion loss 8.5 db. I.F. Maximum Frequency, 1,000 mc.	--	--	Impedance 100-400 ohms	--	--	--	
1N26	Silicon Crystal Converter	--	--	--	Converter	Conversion loss 8.5 db. I.F. Maximum Frequency, 25,000 mc.	--	--	Impedance 100-100 ohms	--	--	--	
1N31	Silicon Crystal Detector	--	--	--	Detector	Video Impedance 6000-24000 ohms. Burnout 0.02 watt Carrier Frequency 10,000 mc.	--	--	Hurnout 0.02 watt	--	--	--	
1N32	Silicon Crystal Detector	--	--	--	Detector	Video Impedance 5000-20000 ohms. Burnout 0.3A watt Carrier Frequency 3,000 mc.	--	--	Burnout 0.3A watt	--	--	--	
1N34	Germanium Crystal Detector	--	--	--	Detector	--	50	60	--	22.5	15	2	Peak volts between any two Electrodes, 250 Max. Control Polarity, Negative
2A4-G	Thyratron Gas Triode	5S	F	2.5	Grid-Controlled Rectifier	200	200	1250	--	100	15	2	Control Polarity, Negative
2C4	Thyratron Miniature Gas Triode	Fig. 17	H	0.6	Grid-Controlled Rectifier	350	350	22	--	5	17	30	Grid No. 1: Circuit Resistance 10 Max. Megohms, -100 Volts Max. Grid No. 2: -100V. Max. Signal Voltage, 8 Volts Peak Grid No. 1: Circuit Resist. 1 Meg. 5 V. RMS Bias, Anode Circuit Resistance, 2000 ohms
2D21	Thyratron Miniature Gas Triode	78N	H	0.6	Grid-Controlled Rectifier	650	1300	500	400 RMS	--	8	10	Grid No. 1: Circuit Resistance 10 Max. Megohms, -100 Volts Max. Grid No. 2: -100V. Max. Signal Voltage, 8 Volts Peak Grid No. 1: Circuit Resist. 1 Meg. 5 V. RMS Bias, Anode Circuit Resistance, 2000 ohms
2V3-G	Half-wave Rectifier	4Y	F	2.5	Rectifier	--	16 500	12	--	2	--	--	--

2X2	Half-wave Rectifier	4AB	H	2.5	1.75	Rectifier	--	12 500	100	4500 Max.RMS	7.5	--	--	--
2Y2	Half-wave Rectifier	4AB	H	2.5	1.75	Rectifier	--	--	--	4500 Max.RMS	5.0	--	--	--
3B26	High Vacuum Diode	4Y	H	2.5	4.6	Clipper Tube	--	15 000	8 000	--	20	--	--	--
3C23	Thyatron Gas Mercury Triode	3G	F	2.5	7.0	Grid-Controlled Rectifier	1250	1250	6 000	--	1500	15	15	Control Polarity, Negative
3G3/C1B	Thyatron Gas Triode	3G	F	2.5	6.0	Grid-Controlled Rectifier	450	700	7 700	--	640	14	40	Max. Grid Current, 25 MA., Control Polarity Negative
3D22	Thyatron Tetraoda	78V	H	6.3	2.6	Grid-Controlled Relay Rectifier	650	1350	6 000 (Cath)	--	750 (Cath)	10	30	
4B22	Full-wave Gas Rectifier	Mogul Screw	F	2.5	12.0	Rectifier	--	340	15 000	--	5000	--	20	Max. Frequency, 150 CPS
4B23	Full-wave Gas Rectifier	Mogul Screw	F	2.5	17.0	Rectifier	--	425	15 000	--	5000	--	120	Max. Frequency, 150 CPS
4B24	Full-wave Gas Rectifier	Special 4-pin	F	2.5	11.0	Rectifier	--	725	10 000	--	2500	13	30	Max. Frequency, 100 CPS
4B25	Full-wave Gas Rectifier	Special 4-pin	F	2.5	17.0	Rectifier	--	700	9400	--	6000	15	40	Max. Frequency, 150 CPS.
4B26	Half-wave Rectifier	Mogul Screw	F	2.2	18.0	Rectifier	--	375	36000	--	6000	8	--	Minimum Starting Voltage 20 Volts RMS Max. Frequency, 60 cps.
4B27	Full-wave Mercury-Vapor Rectifier	Special 4-pin	F	2.5	10.0	Rectifier	--	1000	3100	--	2000	13	60	Max. Frequency, 150 CPS
4B28	Half-wave Gas Rectifier	Mogul Screw	F	2.2	18.0	Rectifier	--	300	36000	--	6000	--	--	Max. Frequency, 80 CPS.
C5B	Thyatron Gas Triode	Mogul Screw	F	2.5	23.0	Grid-Controlled Rectifier	750	1250	30000	--	5000	12	60	Control Polarity, Negative
C6J	Thyatron Gas Triode	Special 4-pin	F	2.5	20.0	Grid-Controlled Rectifier	750	1250	77000	--	6400	14	60	Control Polarity, Negative
6D4	Thyatron Miniature Gas Triode	Fig. 18	H	6.3	0.25	Grid-Controlled Rectifier	360	350	110	--	25	18	30	Control Polarity, Negative
6Q5-G	Thyatron Gas Triode	6Q	H	6.3	0.6	Sweep Osc. or Grid-Controlled Rectifier								
6Y3	Half-wave Rectifier	4Y	F	6.3	0.7	Rectifier	--	14000	100	5000 RMB..Max.	7.5	--	--	--
F6I7	Thyatron Mercury Triode	3G	F	2.5	5.0	Relay or Grid-Controlled Rectifier	2500	5000	2000	--	500	--	5	Max. Grid Current, 250 MA. Mercury Temp. 40 to 80°C. Control Polarity, Negative
F6Z7A	Thyatron Mercury Triode	Fig. 19	F	5.0	4.7	Relay or Grid-Controlled Rectifier	1000	1000	10000	--	2500	--	60	Max. Grid Current, 1.0 Amp. Mercury Temp. 40 to 80°C. Control Polarity, Negative
F632	Half-wave Mercury Rectifier	Fig. 20	H	5.0	4.6	Rectifier	1000	1000	15000	--	2500	--	300	Mercury Temp. 40 to 80°C. Max. Frequency, 150 CPS
F657	Thyatron Mercury Triode	Fig. 21	H	5.0	4.6	Relay or Grid-Controlled Rectifier	1000	1000	15000	--	2500	--	300	Max. Grid Current, 1.0 Amp. Mercury Temp. 40 to 80°C. Control Polarity, Negative
RK-62	Gas Triode	4D	F	1.4	0.05	Super-Regen. Detector Control Tube	--	--	--	45 D.C.	1.5	30	--	Relay Resistance 5000 to 10 000 ohms.
F667	Thyatron Mercury Triode	Fig. 21	H	5.0	4.6	Inverter or Grid-Controlled Rectifier	1000	1000	15000	--	2500	--	300	Max. Grid Current, 1.0 Amp. Mercury Temp. 40 to 80°C. Control Polarity, Positive

For other characteristics, refer to type 884

CONTROL, REGULATOR, AND SPECIAL RECTIFIER TUBES

TYPE	DESIGN	BASE	CATHODE TYPE AND RATING		PURPOSE	MAX. PEAK FORWARD ANODE VOLTAGE (MA.)	MAX. PEAK INVERSE ANODE VOLTAGE (MA.)	OPERATING ANODE VOLTAGE (MA.)	MAX. OPERATING ANODE CURRENT (MA.)	TUBE VOLTAGE DROP	PRE-HEATING TIME (SECONDS)	MISCELLANEOUS DATA
			TYPE	VOLTS AMP.								
72	Half-Wave Rectifier	4P	F	2.5 3.0	Rectifier	--	20 000	--	20.0	--	--	--
73	High-Vacuum Diode	4Y	F	2.5 4.25	Clipper Tube	--	13 000	--	30.0	--	--	--
VR75-30	Gas Voltage Rectifier	4W	Cold	--	Volt. Regulator	For other characteristics, refer to type nA7/VR75						
F681A	Thyatron Gas Triode	3G	F	2.5 5.0	Relay or Grid-Controlled Rectifier	500	500	--	500	--	5	Max. Grid Current, 250 MA. Control Polarity, Negative
VR90-30	Gas Voltage Regulator	4W	Cold	--	Voltage Regulator	For other characteristics, refer to type nB2/VR90						
FG105	Thyatron Mercury Triode	Special Regul 4-Pin Bayonet	H	5.0 10.0	Grid-Controlled Regulator	10 000	10 000	--	4000	--	300	Max. Grid #1 Current, 1 Amp. Max. Grid #2 Current, 2 Amp. Mercury Temp. 25 to 60°C. Control Polarity, Negative
VR105-30	Gas Voltage Regulator	4W	Cold	--	Voltage Regulator	For other characteristics, refer to type nC3/VR105						
VR150-30	Gas Voltage Regulator	4W	Cold	--	Voltage Regulator	For other characteristics, refer to type nD3/VR150						
CE220	Half-Wave Rectifier	4P	F	2.5 3.0	Rectifier	For other characteristics, refer to type 72						
(WE)274A	Full-Wave Regulator	4C	F	5.0 2.0	Rectifier	--	1650	--	175	--	--	--
(WE)274B	Full-Wave Rectifier	5T	F	5.0 2.0	Rectifier	For other characteristics, refer to type (WE)274A						
(WE)346B	Cold Cathode Gas Triode	Special 3-Pin	Cold	--	Rectifier Relay or Regulator	200	200	--	--	80	--	Max. Peak Cathode Cur. 100 MA. Max. Average Cath. Cur. 35 MA. Control Polarity, Positive
(WE)359A	Cold Cathode Gas Triode	Timed Leads	Cold	--	Rectifier Relay or Regulator	165	165	--	--	85	--	Max. Peak Cathode Cur. 50 MA. Max. Average Cath. Cur. 18 MA. Control Polarity, Positive
(WE)359A (OL) 359A (CE)	Thyatron Gas Mercury Triode	Fig. 24	F	2.5 7.0	Grid-Controlled Rectifier	1250	12	--	1500	--	15	Max. Grid Current, 80 MA. Mercury Temp. -40 to +60°C. Max. Freq. 150 CPS. Neg. Cont.
(WE)394A	Thyatron Gas Mercury Triode	Fig. 22	F	2.5 3.2	Grid-Controlled Rectifier	1250	1250	--	640	--	15	Max. Grid Current, 80 MA. Mercury Temp. -40 to +60°C. Max. Freq. 150 CPS. Neg. Cont.
(WE)395A	Cold Cathode Gas Triode	Timed Leads	Cold	--	Rectifier Relay or Regulator	140	140	--	--	80	--	Max. Peak Cathode Cur., 36 MA. Max. Average Cath. Cur. 13 MA. Control Polarity, Positive
502-A	Thyatron Mercury-Vapor Triode	Fig. 32	H	6.3 0.6	Grid-Controlled Rectifier	650	1300	400	500	11	10	
627	Thyatron Mercury-Vapor Triode	3G	F	2.5 6.0	Grid-Controlled Rectifier	1250	2500	--	640	12	10	
629	Thyatron Gas Triode	5A	H	2.5 2.6	Grid-Controlled Rectifier	350	350	--	40	15	30	
(WE)727A	Cold Cathode Gas Triode	Timed Leads	Cold	--	Rectifier Relay or Regulator							

Tube No.	Type	Base	Watts	Grids	Control	Notes	Min. D.C. Starting Voltage, 100. Regulation (10 to 60 mA.) 7%.
874	Gas Voltage Regulator	4S	Cold	--	--	Voltage Regulator	--
876	Current Regulator	Mogul Screw				Regulator	10 Min. 50 Max.
878	Half-Wave Rectifier	Fig. 23	F	2.5	5.0	Rectifier	90 D.C. --
879	Half-Wave Rectifier	4AB	H	2.5	1.75	Rectifier	--
884	Thyatron Gas Triode	60	H	6.3	0.6	Swamp Oscill. Rectifier	30
885	Thyatron Gas Triode	5A	H	2.5	1.5	Rectifier	2 30
886	Current Regulator	Mogul Screw				Regulator	Grid Resistor not less than 1000 OHMS per Max. Instant. volts on Grid. Control Polarity, Negative
967	Thyatron Mercury Triode	3G	F	2.5	5.0	Relay or Grid-Controlled Rectifier	For other characteristics, refer to type 242
991	Neon Voltage Regulator	Bayonet Candel.	Cold	--	--	Voltage Regulator	48 Min. 0.4 Min. 67 Max. D.C. 2.0 Max.
1266	Cold Cathode Regulator	4AJ	--	--	--	Voltage Regulator	Minimum D.C. Starting Voltage, 87
1267	Cold Cathode Regulator	4V	--	--	--	Relay Service	For other characteristics, refer to 0B3/VR80
2000	Half-Wave Gas Rectifier	Mogul Screw	F	2.2	18.0	Rectifier	For other characteristics, refer to 0A4G
2050	Thyatron Gas Triode	88A	H	6.3	0.6	Relay or Grid-Controlled Rectifier	For other characteristics, refer to type 4B26
2051	Thyatron Gas Tetrode	88A	H	6.3	0.6	Relay or Grid-Controlled Rectifier	For other characteristics, refer to type 2D21
							Max. Grid #1 and #2 Voltage, -100 volts. Max. Grid Resistor, 10 Meg.



3G

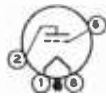

4AA



4AB

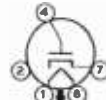

4AH



4AJ



4AM



4B



4BJ



4BR



4C



4D



4E



4F



4G



4J



4K



4L



4M



4P

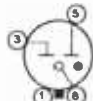

4R



4S



4V



4W



4X



4Y



4Z



5A

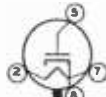

5AA



5AB

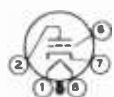

5AC



5AD



5AF



5AG



5AK

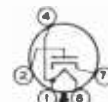

5AL

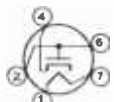

5AM

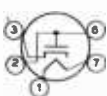

5AP



5B



5BB



5BC



5BD



5BE



5BF



5BG



5BQ

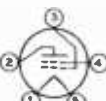

5C



5D



5E



5F

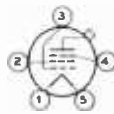

5J

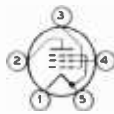

5K



5L



5M

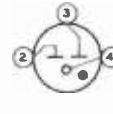

5N



5Q



5R



5S



5T

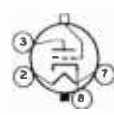

5U



5Y



5Z

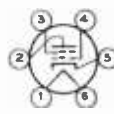

6A



6AA



6AB



6AD



6AE



6AF

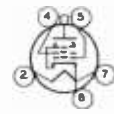

6AM



6AP

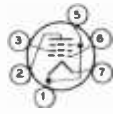

6AR



6AS



6AT

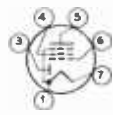

6AU



6AW



6AX



6B



6BA



6BB

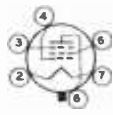

6BD



6BE

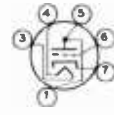

6BG

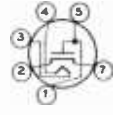

6BH

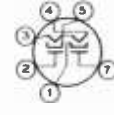

6BT



6BX

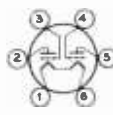

6C

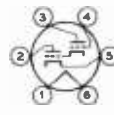

6D

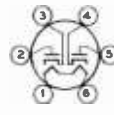

6E



6F



6G

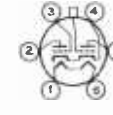

6H

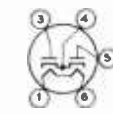

6J



6K

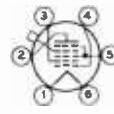

6L

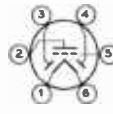

6M



6Q



6R



6S



6T

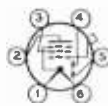

6W

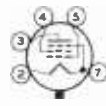

6X



6Y



6Z



7A



7AA

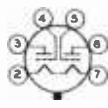

7AB



7AC



7AD

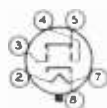

7AG



7AH



7AJ



7AK



7AL



7AM

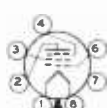

7AO



7AP

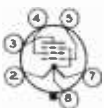

7AQ



7AT



7AU



7AV

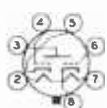

7AX



7AZ

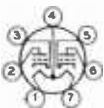

7B

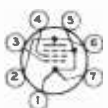

7BA

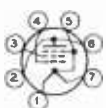

7BB



7BC

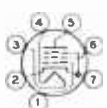

7BD



7BE

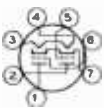

7BF

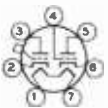

7BH



7BK



7BN



7BQ



7BR

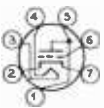

7BS



7BT



7BV



7BZ

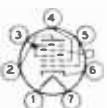

7C



7CC

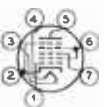

7CH



7CJ

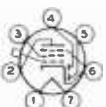

7D



7E



7F



7G



7H



7J

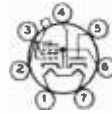

7K



7L



7Q



7R



7S



7T



7U



7V



7W



7Z



8A



8AA



8AB



8AC



8AD



8AE

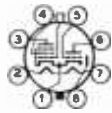

8AF

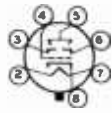

8AG



8AJ



8AL



8AN



8AO



8AR

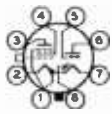

8AS



8AU



8AV

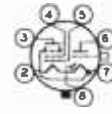

8AW



8AX



8AY



8B



8BA



8BD

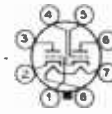

8BE



8BF



8BJ



8BK



8BL



8BN



8BS



8BU



8BV



8BW



8BZ



8C



8E

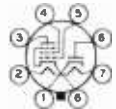

8F



8G



8H



8K

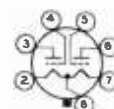

8L



8N

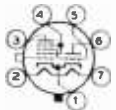

8O



8Q



8R



8S



8T



8U



8V



8W



8X



8Y



8Z



FIG 1

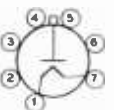

FIG 2



FIG. 3



FIG. 4



FIG. 5



FIG 6



FIG 7



FIG. 8



FIG. 9



FIG. 10



FIG. 11

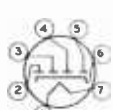

FIG. 12



6BQ
FIG 13

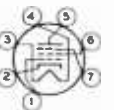
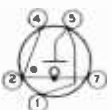

FIG. 14



FIG. 15



5B0
FIG. 16

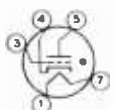

FIG 17



5AY
FIG. 18

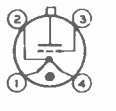

FIG. 19

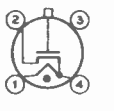

FIG. 20



FIG. 21

CATHODE RAY TUBES															
OSCILLOSCOPE AND TELEVISION RECEIVING TYPES															
TYPE	BASE	HEATER		DEFLEC- TION DIA. (INCHES)	USED AS	FOCUS- ING ANODE No. 1 (VOLTS)	ANODE No. 2 (VOLTS)	GRID No. 1 CUTOFF (VOLTS)	GRID No. 2 (VOLTS)	MAXIMUM PEAK VOLTS BETWEEN ANODE No. 2 & ANY DEFLECTION PLATE (VOLTS)	MAXIMUM FLUORESCENT SCREEN INPUT POWER PER SQ. CENTIMETER (MOVING PATTERN) (MILLIWATTS)	DEFLECTION SENSITIVITY V.D.C./IN. DJ1 & DJ2 DJ3 & DJ4 (VOLTS)	PEAK-TO PEAK SIGNAL SWING (VOLTS)	① SCREEN MATERIAL	
		VOLTS	AMP.												
9AP4/1804-P4	4	2.5	2.1	9	Kinescope	1225 1825	6000 7000	-38 -40	250 250	--	5	--	25	P4	
9CP4	26	2.5	2.1	9	Kinescope	--	7000	-110	--	--	10	--	25	P4	
9BP7	22	6.3	0.6	9	Oscilloscope	--	4000	-45	250	Focusing, 398 Ampere Turns	--	--	--	P7	
9JP1/1809-P1	27	2.5	2.5	9	Oscilloscope	785 1570	2500 5000	-45 -90	--	3000	--	94 185	--	P1	
9LP7	22	6.3	0.6	9	Oscilloscope	--	4000	-80	250	Focusing, 398 Ampere Turns	--	--	--	P7	
10BP4	33	6.3	0.6	10	Kinescope	9000	--	-45	250	--	--	--	--	P4	
12AP4/1803-P4	4	2.5	2.1	12	Picture Tube	1240 1460	6000 7000	-75 -75	250 250	--	5	--	25 25	P4	
12CP4	26	2.5	2.1	12	Picture Tube	--	7000	-110	--	--	10	--	25	P4	
12DP7	21	6.3	0.6	12	Oscilloscope	--	4000	-45	250	Focusing, 398 Ampere Turns	--	--	--	P7	
12BP7	28	6.3	0.6	12	Oscilloscope	1230	Anode #2 4300 Anode #3 5500 ②	-140	--	--	--	73	69	P7	
24-XH	5	6.3	0.6	2	Oscilloscope	120	600	-60	--	--	10	180	158	P5	
902-A	5	6.3	0.6	2	Oscilloscope	100 150	400 600	-80 -80	--	350	5	93 139	78 117	P1	
903	4	2.5	2.1	9	Oscilloscope	1360	7000	-120	250	--	10	--	--	P1	
904	6	2.5	2.1	5	Oscilloscope	970	4600	-140	250	4000	10	--	--	P1	
905-A	7	2.5	2.1	5	Oscilloscope	450	2000	-60	--	1000	10	115	97	P1	
906-P1	1	2.5	2.1	3	Oscilloscope	Same as type 3AP1/900-P1									P1
908-P4	1	2.5	2.1	3	Picture Tube	Same as type 3AP4/900-P4									P4
906-P5	1	2.5	2.1	3	Oscilloscope	Same as type 3AP5/900-P5									P5
907	7	2.5	2.1	3	Oscilloscope	For other characteristics, refer to type 905									P5
908-A	1	2.5	2.1	3	Oscilloscope	For other characteristics, refer to type 3AP1-A									P6
909	7	2.5	2.1	5	Oscilloscope	For other characteristics, refer to type 905									P2
910	1	2.5	2.1	3	Oscilloscope	For other characteristics, refer to type 3AP1-A									P2

5CP4	20	6.3	0.6	Electro-Static	5	Kinescope	For other characteristics, refer to type 5CP1					P4	
5CP5	20	6.3	0.6	Electro-Static	5	Oscilloscope	For other characteristics, refer to type 5CP1					P5	
5FP4A	22	6.3	0.6	Electro-Magnetic	5	Kinescope	--	Anode #2 2000	-45	--	250	--	P4
5CP7	20	6.3	0.6	Electro-Static	5	Oscilloscope	575	Anode #2 2000 Anode #3 4000 (5)	-60	--	550	94 78	P7
5FP7	22	6.3	0.6	Electro-Magnetic	5	Oscilloscope	--	4000	-45	250	Focusing, 398 Ampere Turns		P7
5GP1	2	6.3	0.6	Electro-Static	5	Oscilloscope	337	1500	-30	--	550	52 54	P1
5HP1-A	2	6.3	0.6	Electro-Static	5	Oscilloscope	337 425	1500 2000	-30 -40	--	500	63 85 77	P1
5HP4	2	6.3	0.6	Electro-Static	5	Kinescope	For other characteristics, refer to type 5HP1-A					P4	
5JP1	23	6.3	0.6	Electro-Static	5	Oscilloscope	390	Anode #2 1500 Anode #3 3000 (5)	-56	--	500	77 68	P1
5JP2	23	6.3	0.6	Electro-Static	5	Oscilloscope	For other characteristics, refer to type 5JP1					P2	
5JP4	23	6.3	0.6	Electro-Static	5	Kinescope	For other characteristics, refer to type 5JP1					P4	
5JP5	23	6.3	0.6	Electro-Static	5	Oscilloscope	For other characteristics, refer to type 5JP1					P5	
5LP1	24	6.3	0.6	Electro-Static	5	Oscilloscope	375	Anode #2 1500 Anode #3 3000 (5)	-45	--	550	77 68	P1
5LP2	24	6.3	0.6	Electro-Static	5	Oscilloscope	For other characteristics, refer to type 5LP1					P2	
5LP4	24	6.3	0.6	Electro-Static	5	Kinescope	For other characteristics, refer to type 5LP1					P4	
5LP5	24	6.3	0.6	Electro-Static	5	Oscilloscope	For other characteristics, refer to type 5LP1					P5	
5NP1	1	2.5	2.1	Electro-Static	5	Oscilloscope	250 375	1500 1500	-33 -50	--	660	60	P1
5NP4	1	2.5	2.1	Electro-Static	5	Kinescope	For other characteristics, refer to type 5NP1					P4	
5NP5	1	2.5	2.1	Electro-Static	5	Oscilloscope	For other characteristics, refer to type 5NP1					P5	
5NP1	2	6.3	0.6	Electro-Static	5	Oscilloscope	337	1500	-30	--	500	64 57	P1
5TP4	31	6.3	0.6	Electro-Magnetic	5	Kinescope	4900	27000	-70	200	--	--	P4
7AP4	3	2.5	2.1	Electro-Magnetic	7	Kinescope	675	3500	-67.5	--	5	15	P4
7BP7/1813-P7	22	6.3	0.6	Electro-Magnetic	7	Oscilloscope	--	4000	45	250	Focusing, 398 Ampere Turns		P7
7CP1	25	6.3	0.6	Electro-Magnetic	7	Oscilloscope	780 1365	4000 7000	-45 -45	250 250	--	--	P1
7CP4	25	6.3	0.6	Electro-Magnetic	7	Kinescope	1140	6000	-45	250	--	--	P4
7DP4	32	6.3	0.6	Electro-Magnetic	7	Kinescope	1430	6000	-45	250	--	--	P4
7GP4	18	6.3	0.6	Electro-Static	7	Kinescope	1200	3000	-84	--	--	--	P4

CATHODE RAY TUBES
OSCILLOSCOPE AND TELEVISION RECEIVING TYPES

TYPE	BASE	HEATER		DEFLEC- TION	SCREEN DIA. (INCHES)	USED AS	FOCUS- ING ANODE No 1	ANODE No 2 CUTOFF	GRID No 1 No 2	MAXIMUM PEAK VOLTS BETWEEN ANODE No 2 & ANY DEFLECTION PLATE	MAXIMUM FLUORESCENT SCREEN INPUT POWER PER SQ. CENTIMETER (MOVING PATTERN)	DEFLECTION SENSITIVITY V.D.C./IN.		PEAK-TO PEAK SIGNAL SWING (VOLTS)	① SCREEN MATERIAL		
		VOLTS	AMP.									DJ1 & DJ2	DJ3 & DJ4				
2AP1-A	17	6.3	0.6	Electro- Static	2	Oscilloscope	125 250	500 1000	-30 -60	--	--	115 130	98 196	--	P1		
2BP1	29	6.3	0.6	Electro- Static	2	Oscilloscope	280 560	1000 2000	-67.5 -135	--	--	155 310	100 200	--	P1		
2BP11							Same as 2BP1 except screen material designed for photographic recording										
3AP1-A	1	2.5	2.1	Electro- Static	3	Oscilloscope	285 475	1000 1500	-34 -50	--	10	76 114	73 109	--	P1		
3AP4/906-P4	1	2.5	2.1	Electro- Static	3	Kinescope	For other characteristics, refer to type 3AP1										P4
3AP5/906-P5	1	2.5	2.1	Electro- Static	3	Oscilloscope	For other characteristics, refer to type 3AP1										P5
3BP1-A	18	6.3	0.6	Electro- Static	3	Oscilloscope	430 575	1500 2000	-45 -60	--	--	150 200	111 148	--	P1		
3BP1	18	6.3	0.6	Electro- Static	3	Oscilloscope	431	1500	-45	--	--	150	--	--	P1		
3EP1/1806-P1	2	6.3	0.6	Electro- Static	3	Oscilloscope	431	1500	-45	--	--	165	124	--	P1		
3FP7	20	6.3	0.6	Electro- Static	3	Oscilloscope	575	Anode #2 2000 Anode #3 4000	-60	--	--	250	180	--	P7		
3BP1	19	3.3	0.6	Electro- Static	3	Oscilloscope	234 250	1000 1500	-33 -50	--	--	79 120	71 105	--	P1		
3BP4	19	6.3	0.6	Electro- Static	3	Oscilloscope	For other characteristics, refer to type 3BP1										P4
3BP5	19	6.3	0.6	Electro- Static	3	Oscilloscope	For other characteristics, refer to type 3BP1										P5
3HP7	21	6.3	0.6	Electro- Magnetic	3	Oscilloscope	--	4000	-27	150	Focusing, 398 Ampere turns	--	--	--	P7		
3RP1	30	6.3	0.6	Electro- Static	3	Oscilloscope	300 600	1000 2000	-45 -90	--	--	500 --	68 136	52 104	P1		
5AP1/1805-P1	2	6.3	0.6	Electro- Static	6	Oscilloscope	432 575	1500 2000	-27 -35	--	10	110 150	90 120	15 20	P1		
5AP4/1800-P1	2	6.3	0.6	Electro- Static	5	Kinescope	For other characteristics, refer to type 5AP1/1800-P1										P4
5BP1	2	6.3	0.6	Electro- Static	5	Oscilloscope	310 425	1500 2000	-21 -35	--	10	63 84	57 76	--	P1		
5BP2	2	6.3	0.6	Electro- Static	5	Oscilloscope	For other characteristics, refer to type 5BP1										P2
5BP4/1002-P4	2	6.3	0.6	Electro- Static	5	Kinescope	For other characteristics, refer to type 5BP1										P4
5BP5	2	6.3	0.6	Electro- Static	5	Oscilloscope	For other characteristics, refer to type 5BP1										P5
5CP1-A	20	6.3	0.6	Electro- Static	5	Kinescope	430	Anode #2 1500 Anode #3 3000	-45	--	550	69	59	--	P1		

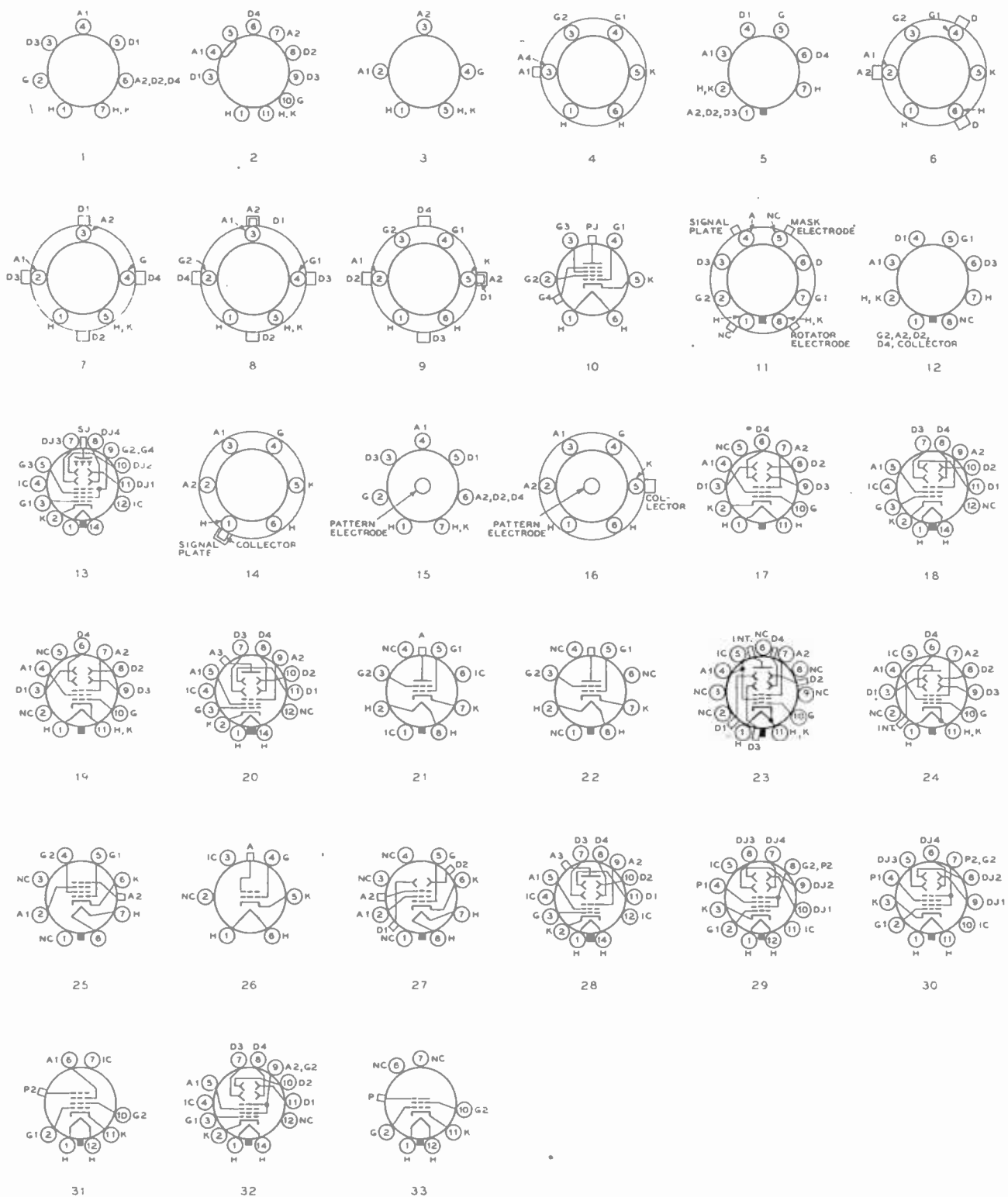

CATHODE-RAY TRANSMITTING TYPES

TYPE	USED AS	BASE CONN'S	HEATER		ANODE N° 1	ANODE N° 2	GRID #1 CUTOFF VOLTS	GRID #2 VOLTS	COLLECTOR		AVERAGE D.C. DEF. PLATE VOLTS	ROTATOR ELECTRODE VOLTS	MASK ELECTRODE VOLTS	DEFLECTING FLUX DENSITY GAUSSSES	FOCUSING DENSITY GAUSSSES	PEAK-TO-PEAK DEFLECTING VOLTAGE		TYPE OF PICKUP OR FILM	
			VOLTS	AMP.					VOLTS	AMPS						HORIZ.	VERT.		
2F21	MONSCOPE	10	6.3	0.6	—	—	-50	1000	GRID 3, 300 VOLTS. GRID 4, 1050 VOLTS. PATTERN, 1000 VOLTS, 5" DIAMETER										
1840	ORTHICON	11	6.3	0.6	250	—	-40	225	—	—	225	100 APPROX.	-3	25 APPROX.	70 APPROX.	180	—	DIRECT OR FILM	
1847	ICONOSCOPE	12	6.3	0.6	150	600 (3)	-120 APP.	600 (3)	600 (3)	—	—	—	—	—	—	200	225	DIRECT	
1849	ICONOSCOPE	14	6.3	0.6	360	1000	-30 APP.	—	1000	0.05 TO 0.10	—	—	—	—	—	—	—	FILM	
1850A	ICONOSCOPE	14	6.3	0.6	FOR OTHER CHARACTERISTICS, REFER TO TYPE 1849											DIRECT			
5527	ICONOSCOPE	13	6.3	0.6	—	—	-100 MAX.	900 MAX.	GRID 3, 125-250; SIGNAL ELECTRODE 900 MAX.; 2" DIAMETER SCREEN										DIRECT

Transmitting Tubes

TRANSMITTING TUBES (Plate Dissipation)

TRIODES

- | | |
|---|--|
| 1.5 Watts—RK24 | 85 Watts—V70D, 242C, WE284D, 342B, 8005 |
| 2 Watts—HY24, HY114B | 100 Watts—2C39, RK36, RK38, RK58, 100TH 100TL, HF120, HF125, V127A, HF140, 203A, WL195, 203H, 211, 211D, 227A, HK254, 276A, WE295A, 303A, 311, 327A, WL469, 838, 845, 852, 938, 8003 |
| 2.5 Watts—RK33 | 125 Watts—3C22, 4C36, RK57, F123A, T125, HF130, GL146, HF150, GL152, HF175, 211C, 211H, HD211C, 261A, 331A, 805, 835 |
| 3 Watts—2C22 | 150 Watts—TW150, 150T, 152TH, 152TL, HD203A, HF250, HK252L, HK354, HK354C, HK354D, HK354E, HK354F, 810, 1627, 8000 |
| 3.5 Watts—GL446B, HY6J5, HY615, 7193 | 200 Watts—4C32, 4C34, HV12, HV18, HV27, RK63, F127A, T200, HF200, HF300, WL460, WL468, T814, T822, 5588 |
| 5 Watts—2C40, 2C43, 2C44, 6C4, GL464A, 1626 | 225 Watts—806 |
| 6 Watts—5556 | 250 Watts—GL159, GL169, 204A, 250TH, 250TL, WE308B, HK454H, HK454L |
| 10 Watts—2C26, 6N7, RK34 | 275 Watts—212E, WE241B, 312E |
| 12 Watts—802, 842 | 300 Watts—304TH, 304TL, 527, GL592, HK654 |
| 14 Watts—205F, 305D | 350 Watts—WE270A, WE357B |
| 15 Watts—2C25, 10, 10Y, RK10, VT25A, RK59, HY75, 801, 843, 1602 | 400 Watts—849 |
| 20 Watts—15E, T20, TUF20, TZ20, WE368A, 1608 | 450 Watts—450TH, 450TL, HK854H, HK854L |
| 25 Watts—3C24, 3C28, 3C34, RK11, RK12, HK24, 25T, HK24G, HY25, 25TG, 3-25D3, WE268A | 700 Watts—F128A |
| 30 Watts—HY30Z, HY31Z, WE316A, 809, HY1231Z, 1623, 8025A | 750 Watts—851 |
| 35 Watts—RK30, 53A, 800 | 1000 Watts—WE251A, 750TL, 1000T |
| 40 Watts—RK18, RK31, HY40, HY40Z, T40, TZ40, HY57, WE300B, 756, 830, 1628, 8012A | 1200 Watts—WE279A |
| 50 Watts—RK32, 35T, 35TG, RK35, RK37, UH50, UH51, HK54, HK154, HK158, WE364A, 808, 834, 841A, 8415W, 8010R. | 1500 Watts—1500T |
| 55 Watts—811, 812 | 2000 Watts—7C24, 2000T |
| 60 Watts—RK51, T60, HF60, WE356B, 826, 830B, 930B | 2500 Watts—3X2500A3 |
| 62.5 Watts—RK52 | |
| 65 Watts—HY51A, HY51Z, 203Z, 5514 | |
| 70 Watts—UH35 | |
| 75 Watts—4C22, 50T, HF75, TW75, 75TH, 75TL, HF100, TF100, 111H, ZB120 | |

TETRODES AND PENTODES

- | | |
|--|---|
| 3 Watts—HY63 | 50 Watts—HK57, 4D22, 4D32, RK47, WE312A, 804 |
| 3.5 Watts—6AK6 | 60 Watts—WE305A |
| 6 Watts—3E29, RK64, 1610 | 65 Watts—814, 4-65A |
| 8 Watts—RK56, 6AQ5, 6V6 | 70 Watts—WE282A |
| 10 Watts—2E24, 2E26, 2E30, 6AG7, RK23, RK25B, RK45, HY65, 1613 | 75 Watts—4E27, HK257 |
| 12 Watts—6F6, RK44, 837 | 80 Watts—828 |
| 15 Watts—2E25, HY60, RK75, WE306A, WE307A, 932A, 865, 1619, 5516 | 100 Watts—RK48, 850, 860 |
| 20 Watts—WE254A | 125 Watts—813, 4D21, RK28A, 4-125A, 322A, 803 |
| 21 Watts—6L6, T21, RK49, 1614 | 150 Watts—4X150A |
| 25 Watts—RK39, RK41, HY61, WE254B, WE367A | 215 Watts—RK65 |
| 30 Watts—2E22, RK66, WE350A, 807, 1625 | 250 Watts—4-250A |
| 35 Watts—3D23, 3E22, TB35 | 350 Watts—WE363A |
| 40 Watts—RK20A, RK46, HY69, 829B, HY1269 | 400 Watts—861 |
| 45 Watts—WE339A, 5562 | 500 Watts—4X500A |
| | 750 Watts—4-750A |
| | 800 Watts—827R |

Prefixes used by tube manufacturers: AmpereX—A, HF, ZB. Continental Electric—CE. Eitel-McCullough (Eimac)—UH, RF (also suffixes T, TH & TL). Federal—F. General Electric—GL. Hytron—HY. RCA Manufacturing Co.—none. Raytheon—RK, CK, RX. Sylvania—none. Taylor—T, TT, TZ. United Electronics—BW, CV, CW, HV, UX, VE. Western Electric—D, WE. Westinghouse—WL.

MFR. NO.	HEATER OR FILAMENT TYPE	HEATER OR FILAMENT (VOLTS)(AMP)	BASE	MAX. PLATE VOL-TAGE (VOLTS)	MAX. TRIODE MU OR MAX. SCREEN VOLTAGE (VOLTS)	MAX. DC CONTROL CUR-RENT (MA.)	MAX. PLATE DISSIPATION (WATTS)	INTERELECTRODE CAPACITANCES (P-F)		MAX. FULL-RATE FREQ. (MC.)	TYPICAL OPERATION	PLATE VOLTAGE (VOLTS)	CON-TROL GRID BIAS (VOLTS)	SCREEN VOLTAGE (VOLTS)	SUP-PRES-SOR VOLTAGE (VOLTS)	PLATE CUR-RENT (MA.)	D.C. CON-TROL GRID CUR-RENT (MA.)	SCREEN CUR-RENT (MA.)	LOAD IMPEDANCE (OHMS)	POWER OUTPUT (WATTS)	MFR.	
								IN-PUT	OUT-PUT													
2C21	Twin Triode	6.3 0.6	7-Pin 48	250	10.4			2.6 1.4 2.6 2.0	2.4 1.8		Class A Audio	250	-16.5		8.3						Kenrad	
2C22	Triode	6.3 0.3	8-Pin 32	300	20		3.5	2.2 0.7	3.6		Class A Audio	300	-10.5		11						RCA	
2C25	Triode	7.0 1.18	4-Pin 3	450	8	15	15	4.1 3.0	7.0		Class C Telegraphy	450	-100		65	15		3.2		19		
2C26	Triode	6.3 1.15	8-Pin 32	350	16.3		10	2.6 1.1	2.8	250	Special Oscillator Pulse Applications	350	-15		50	12		2.2		12		
2C34	Twin Triode	6.3 0.8	7-Pin 22							250					16							
2C39	Triode	6.3 1.1	Special	1000	100	50	100	6.5 .03	1.95	500	Class C Telegraphy	600	-95		60	40		5		20	Edmac.	
2D0	Triode	6.3 0.75	6-Pin 81	450	36		5	2.1 .02	1.3		Class C Telegraphy	450			22						RCA	
2D3	Triode	6.3 0.9	5-Pin 49	500	48		5	2.7 0.1	2.0	1250	Class C Telegraphy	450									G.E. RCA	
2D5	Triode	7.0 1.18	4-Pin 3	250	3.6		10	5.0 3.0	7.7		Class A Audio	250	-40		29				1			
2E2	Pentode	6.3 1.5	5-Pin 11	750	250		30	13 8.0	0.2		Class C Telegraphy	750	-70		100	6	16	.55		53	Kenrad	
2E2A	Beam Tetrode	6.3 0.65	8-Pin 76	500	200	3.5	9	8.5 6.5	0.11	125	Class C Telegraphy	600	-50		66	3	10	.21		27	RCA	
2E2S	Beam Tetrode	6.0 0.8	7-Pin 86	450	250	4.5	15	8.5 6.0	0.15	100	Class C Telegraphy	450	-70		75	3	15	.36		22	Ryton	
2E2E	Beam Tetrode	6.3 0.8	8-Pin 77	600	200	3.5	10	13 7	0.2	125	Class C Telegraphy	600	-45		66	3	10	.17		27	RCA	
2E30	Beam Pentode	6.0 0.65	7-Pin 87	250	250	3	10	9.6 14	0.18	165	Class C Telegraphy	250	-50		50	2.5	10	.2		7.5		
2A35	Split Plate Magnatron	1.8 2.0	4-Pin 50	1000	5		4				Magnatron Oscillator	1000			4					1	RCA	
3B21	Gas Rectifier	2.5 5.5	4-Pin 51	3400 Inverse Peak							D.C. Stabilizing-Electrode Voltage, (50 volts, current, 10 MA.)				1000 Average							
3B22	Gas Rectifier	2.5 6.25	4-Pin 51	725 Inverse Peak							D.C. Stabilizing-Electrode Voltage, (50 volts, current, 10 MA.)				1000 Average							
3B23	MI-Vacuum Rectifier	2.5 8.0	4-Pin 2								For other characteristics, refer to R5-22											
3B24	MI-Vacuum Rectifier	2.5 .3 5.0 .15	4-Pin 52	2000 Inverse Peak							For other characteristics, refer to R5-22				30 60							

3B25	3C22	3C24	3C28	3C34	3C33	3C34	3E23	4C22	4C32	4C34	4C36	4D21 4-125A	4D22	4D32	4E27	6A07	6A08	6A09	6C4	6F6	6Y- 6Y5 6Y6	6L6
3B25	3C22	3C24	3C28	3C34	3C33	3C34	3E23	4C22	4C32	4C34	4C36	4D21 4-125A	4D22	4D32	4E27	6A07	6A08	6A09	6C4	6F6	6Y- 6Y5 6Y6	6L6
2.5	6.3	6.3	6.3	6.3	6.3	6.3	6.3	10	10	11	5	12.6	6.3	6.3	6.3	6.3	6.3	6.3	6.3	6.3	6.3	6.3
5.0	2.0	3.0	3.0	3.0	2.75	3.0	2.25	2	4.5	4	7.5	1.6	3.75	7.5	.65	.15	.15	.15	.7	.3	.3	.9
4-Pin 1	6-Pin 90	4-Pin 5	4-Pin 53	4-Pin 6	4-Pin 92	8-Pin Loktal	Special 24	4-Pin 5	4-Pin Giant 91	4-Pin Giant 13	4-Pin Giant 53	Special 93	Special 94	7-Pin Giant 25	8-Pin 82	7-Pin 83	7-Pin 84	7-Pin 54	7-Pin 47	Special 42	7-Pin 43	
2000 Inverse Peak	1000	2000	2000	2000	2000	2000	600	3000	3000	4000	3000	750	Special	Special	375	375	350	350	400	250	250	400
40	150	75	75	75	65	90	175	30	300	29	400	225	300	225	30	15	47	18	50	25	20	100
70	125	25	25	25	35	35	11	60	200	125	15	50	50	15	5	3	5	8	5	3	4	5
500	500	60	100	60	250	125	15	60	60	60	120	60	60	10	54	54	54	10	10	10	10	10
2.4	2.4	1.5	1.6	1.7	0.2	0.2	8.5	0.22	5.8	3.0	0.05	0.27		0.06	0.12	0.35	1.6	0.2	0.2	2.7	0.4	
.05	0.3	0.2	0.4	0.4	1.8	2.4	14	1.1	5.5	0.4	3.1	13		7.5	4.2	6.0	1.3	13	3	3.0	12	
4.3	1.7	1.8	2.5	2.5	6.5	6.5	6.0	3.2	10.8	20	10.8	28		13	3.6	7.6	1.8	6.5	3.8	3.8	10	
125	25	25	25	25	35	35	35	200	200	125	125	50	50	15	9	3	8	5	12.5	3.5	21	
70	25	25	25	25	25	25	11	60	60	29	15	50	50	15	5	3	5	8	5	4	5	
100	100	100	100	100	100	100	100	100	100	100	100	100	100	100	100	100	100	100	100	100	100	100
Class C Telegraphy	Class C Telegraphy	Class C Telegraphy	Class C Telegraphy	Class C Telegraphy	Class C Telegraphy	Class C Telegraphy	Class C Telegraphy	Class C Telegraphy	Class C Telegraphy	Class C Telegraphy	Class C Telegraphy	Class C Telegraphy	Class C Telegraphy	Class C Telegraphy	Class C Telegraphy	Class C Telegraphy	Class C Telegraphy	Class C Telegraphy	Class C Telegraphy	Class C Telegraphy	Class C Telegraphy	Class C Telegraphy
1000	2000	1000	2000	2000	1500	2000	600	2000	2000	2000	3000	600	500	2000	375	375	350	300	250	250	250	
-200	-170	-175	-300	-300	-300	-300	-55	-165	-200	-200	-200	-100	-100	-100	-250	-27	-27	-27	-30	-30	-30	
140	63	75	70	110	90	160	160	275	250	250	167	152	260	215	175	30	15	47	25	20	20	
65	4.5	25	15	15	10	7	6.5	20	20	20	9	9	10	6	1	3	7	7	7	2	2.5	
65	100	35	100	130	140	72	67	400	375	400	375	300	300	520	7.5	4	11	5.5	14	3	3	
RCA Kernad			Taylor		Sylvania	RCA		RCA Kernad	AMP.	AMP.					RCA	RCA	RCA	RCA	RCA	Bytron	RCA	
For R.F. characteristics, refer to R22B																						
For other characteristics, refer to RP31a1																						
For other characteristics, refer to RP31a																						
For other characteristics, refer to RP31a																						
For other characteristics, refer to 4B22																						
Identical to type 3F01																						
Max. screen current 11 MA.																						
Max. screen current 12 MA.																						

MFR. NO.	HEATER OR FILAMENT TYPE	HEATER OR FILAMENT (VOLTS)(AMP)	BASE	MAX. PLATE VOL-TAGE (VOLTS)	MAX. PLATE CUR-RENT (MA)	TRIODE MU OR MAX. SCREEN VOLTAGE (VOLTS)	MAX. DC CONTROL CUR-RENT (MA)	MAX. DIS-SIPATION (WATTS)	INTERELECTRODE CAPACITANCES (P-F)			MAX. FULL-RATING (MC)	TYPICAL OPERATION	PLATE VOLTAGE (VOLTS)	CON-TROL GRID BIAS (VOLTS)	SCREEN VOLTAGE (VOLTS)	SUP-PRES-SOR (VOLTS)	PLATE CUR-RENT (MA)	D.C. CON-TROL CUR-RENT (MA)	SCREEN CUR-RENT (MA)	GRID DRIVING POWER APPROX P TO P (WATTS)	LOAD IMPEDANCE (OHMS)	POWER OUTPUT TYPICAL (WATTS)	MFR. C
									G-F	P-F	G-P													
6K7	Diode Triode	6.3	.8	8-Pin 85	30 per plate	35	5 per grid	5.5 per plate				10	Class C Telegraphy										14.5	REA
6X6 6T	Beam Tetrode	6.3	.45	7-Pin 43	47	250	5	8	9.5	7.5	0.7	10	Class C Telegraphy	Max screen current 7 MA.									11	REA
7A24	Triode	12.6	.29	Special	1400	25	300	2000	19	0.45	16	110	Class C Telegraphy	-400									4550	REA
10 10Y RK-10	Triode	7.5	1.25	4-Pin 3	450	8	15	15	4.1	3.0	7.0	60	Class C Telegraphy	-350									2600	REA
RK-11	Triode	6.3	.3	4-Pin 6	750	20	35	25	7	0.9	7		Class C Telegraphy	-120									55	RAT.
HN-12	Triode	10	.4	4-Pin Giant 28	2500	12	60	200	8.5	4	14.0	30	Class C Telegraphy	-300									300	Indial
RK-12	Triode	6.3	.3	4-Pin 6	750	100	40	25	7	0.9	7	60	Class C Telegraphy	-100									55	RAT.
15E	Triode	5	.4	56	12500	25	20	20	1.4	0.3	1.15	400	Oscillator at 400 MC.										15	ETMAC
15R	Hi-Vacuum Rectifier	5	.4	Spec-1A	150 peak								Half-Wave Rectifier											ETMAC
HN-18	Triode	10	3.85	4-Pin Giant 13	2500	18	60	200	5	1.5	6.5	20	Class C Telegraphy	-300									375	(Indial)
RK-18	Triode	7.5	.3	4-Pin 6	1250	18	40	40	6	1.8	4.8	60	Class C Telegraphy	-160									95	RAT.
RK-19	Hi-Vacuum Rectifier	7.5	2.5	4-Pin 2	3500 Inverse Peak								Full-Wave Rectifier	1250										RAT.
RK-20A	Pentode	7.5	3.25	5-Pin 11	1250	300	15	40	14	12	0.01		Class C Telegraphy	-100									84	RAT.
T-20	Triode	7.5	1.75	4-Pin 6	750	20	200	20	4.85	0.65	5.05	60	Class C Telegraphy	-85									44	Taylor
TUF-20	Triode	6.3	2.75	5-Pin 31	750	10	20	20	1.8	0.9	3.5	250	Class C Telegraphy	-135									38	Taylor
TZ-20	Triode	7.5	1.75	4-Pin 6	750	62	30	20	5.25	0.55	4.95	60	Class C Telegraphy	-100									40	Taylor
KY-21	Grid Control Mercury Vapor Rectifier	2.5	10	4-Pin 6	11000 Inverse Peak								Half-Wave Rectifier	750										ETMAC

Model	Diode Type	Pinout	600 Peak	3500 Inverse Peak	4-Pin	4-Pin	2.5	4	3500 Inverse Peak	600 Peak	5	21	3-5	11-5	11-5	1-4	30	Diode Type	1250 per Plate	200	RAY		
RK-21	Hi-Vacuum Rectifier	4	2.5	4	4-Pin	3500 Inverse Peak	600 Peak	5	21	3-5	11-5	11-5	1-4	30	Class C Telegraphy	400	45	300	95	5	16	.4	17
RK-21	Mercury Vapor Rectifier	10	2.5	10	5-Pin	11000 Inverse Peak	3000 Peak	10	5	3-5	11-5	11-5	1-4	30	Class C Telegraphy	400	45	300	95	5	16	.4	17
T-21	Beam Triode	9	6.3	9	5-Pin	400	95	5	21	3-5	11-5	11-5	1-4	30	Class C Telegraphy	400	45	300	95	5	16	.4	17
RK-22	Hi-Vacuum Rectifier	8	2.5	8	4-Pin	3500 Inverse Peak	600 Peak	10	25	8	10	10	0.2		Class C Telegraphy	500	+45	200	55	4	38	.5	22
RK-23	Penode	2	2.5	2	7-Pin	500	60	10	25	8	10	10	0.2		Class C Telegraphy	400	-90	150	43	6	30	.8	13.5
HK-24	Triode	3	6.3	3	4-Pin	2000	75	25	25	2.1	0.2	1-3	1-3	300	Class C Telegraphy	2000	-140		56	18		4	90
HK-24G	Triode	3	6.3	3	4-Pin			25	25	2.1	0.2	1-3	1-3	300	Class C Telegraphy	1500	-145		50	25		5.5	60
HY-24	Triode	13	2	13	4-Pin	180	20	4.5	2	2.7	2.3	5-4	5-4	60	Class B Audio	180	-18		20			.26	9200
RK-24	Triode	12	2	12	4-Pin	180	20	6	1.5	3.5	3	5-5	5-5	125	Class C Telegraphy	180	-45		16.5	6		.5	2
25-T	Triode	3	6.3	3	4-Pin	2000	75	25	25	2.7	0.3	1-5	1-5	110	Class C Telegraphy	2000	-130		63	18		4	100
HY-25	Triode	2.25	7.5	2.25	4-Pin	800	75	25	25	4.2	1.0	4-6	4-6	60	Class C Telegraphy	750	-45		70	15		.2	42
RK-25	Penode	.9	6.3	.9	7-Pin	500	60	10	10	8	10	0.2	0.2		Class C Telegraphy	500	-90	200	55	4	38	.5	22
RK-25B	Penode	.9	6.3	.9	7-Pin	500	60	10	10	8	10	0.2	0.2		Class C Telegraphy	400	-90	150	43	6	30	.8	13.5
VT-25A	Triode	1.18	7	1.18	4-Pin										Sup. Mod. Telegraphy	500	-125	200	31	4	39	.5	6
25TG	Triode	3	6.3	3	4-Pin										Class C Telegraphy	180	-45		20	4.5		.2	2.7
3-25G3	Triode	3	6.3	3	4-Pin										Class C Telegraphy	180	-45		20	4.5		.3	2-5
HY-27	Triode	4	10	4	4-Pin	2500	210	26	200	8.5	3.5	14-5	14-5	30	Class C Telegraphy	2000	-300	200	200	12		9	300
RK-28A	Penode	5	10	5	5-Pin	2000	150	400	125	15	15	0.02	0.02		Class C Telegraphy	1500	-100	400	135	10	60	1.6	250
HY-30Z	Triode	2.25	6.3	2.25	4-Pin	850	90	87	30	6	1	4-8	4-8	60	Class C Telegraphy	850	-75	90	90	25		2.5	58
RK-30	Triode	3.25	7.5	3.25	4-Pin	1250	80	15	35	2.75	2.75	2.5	2.5	60	Class C Telegraphy	1000	-200	180	90	15		3.5	47
										2.75	2.75	2.5	2.5	60	Class C Telegraphy	1250	-180	180	90	18		2	110
															Class B Audio	1250	-70	130	130	26		3.4	106

MFR. NO.	TYPE	HEATER OR FILAMENT		MAX. PLATE VOLTAGE (VOLTS)	MAX. TRIODE OR SCREEN VOLTAGE (VOLTS)	MAX. DC CONTROL GRID CURRENT (MA.)	MAX. PLATE DISSIPATION (WATTS)	INTERELECTRODE CAPACITANCES (P.F.)		MAX. FULL-RATING (MC)	TYPICAL OPERATION	PLATE VOLTS (VOLTS)	CON-TROL GRID BIAS (VOLTS)	SCREEN VOLTS (VOLTS)	SUP-PRES-CUR-VOLTS (VOLTS)	I-PLATE CUR-RENT (MA.)	D.C. CON-TROL GRID CUR-RENT (MA.)	SCREEN CUR-RENT (MA.)	GRID DRIVING POWER (APPROX TO P)	LOAD IMPEDANCE (OHMS)	POWER OUTPUT (WATTS)	MFR.
		VOLTS	(AMP.)					G-F IN-PUT	P-F OUT-PUT													
8Y-31Z	Triode	6.3	3.5	500	45	3.2	22	5	1.5	5.5	Class C Telephony	500	-45		150	25		2.5		56	10 Iron	
	Triode	6.3	3.5	400				per section		60	Class C Telephony	400	-45		150	30		3.5	7000	45		
	Triode	6.3	3.5	500						51	Class B Audio	500	C		150			1.3		51		
8K-31	Triode	7.5	3	1250	75	76	40	7	2	10	Class C Telephony	1250	-80		130	30		3.9		90	RAY	
	Triode	7.5	3	1000						50	Class C Telephony	1000	-80		100	25		3.5	18000	70		
	Triode	7.5	3.25	1250	11	25	50	2.5	0.7	5.4	Class B Audio	1250	0		220	76		4.4		190		
8K-32	Triode	7.5	3	1250	11	25	50	2.5	0.7	5.4	Class C Telephony	1250	-225		100	14		4.8		90	RAY	
	Triode	7.5	3	250	15	6	2.5	3.0	2.5	2.0	Class C Telephony	1000	-510		100	21		8.7		70		
	Triode	7.5	3	250						100	Class C Telephony	1000	-510		100	21		8.7		70		
8K-33	Triode	7.5	3	1250	11	25	50	2.5	0.7	5.4	Class C Telephony	1250	-60		20	6		.5%		3.5	RAY	
	Triode	7.5	3	1000						100	Class C Telephony	1000	-60		20	6		.5%		3.5		
8K-34	Triode	6.3	4	3000	30	20	10	4.2	0.8	2.7	Class C Telephony	300	-36		80	22		1.8		16	RAY	
	Triode	6.3	4	2000						250	Class B Audio	300	-15		70	12		.5	10000	13		
8B-35	Beam Triode	6.3	2.75																			
	Triode	5	4	1500	30	55	70	1.4	0.2	1.6	Class C Telephony	1500	-170		150	30		7		170	RAY	
	Triode	5	4	1500						60	Class C Telephony	1500	-120		100	30		5		160		
35T	Triode	5	4	2000	50	50	50	4.1	0.3	1.8	Class C Telephony	2000	-135		125	45		13		230	RAY	
	Triode	5	4	2000						100	Class C Telephony	2000	-120		100	30		15		150		
	Triode	5	4	2000						167	Class B Audio	2000	-40		167			4	27500	235		
35T6	Triode	5	4	2000	30	50	50	2.5	0.4	1.8	Class C Telephony	1500	-250		115	15		5		120	RAY	
	Triode	5	4	1500						60	Class C Telephony	1500	-250		100	14		4.6		95		
8K-36	Triode	5	4	3000	14	35	100	4.5	1.2	5.0	Class C Telephony	2000	-860		150	30		15		230	RAY	
	Triode	5	4	3000						60	Class C Telephony	2000	-560		150	30		15		230		
8K-37	Triode	7.5	4	1500	30	35	50	3.5	0.2	3.2	Class C Telephony	1500	-130		115	30		7		124	RAY	
	Triode	7.5	4	1500						60	Class C Telephony	1500	-150		100	23		5.6		90		
8K-38	Triode	5	6	3000	30	40	100	4.6	0.9	4.3	Class C Telephony	2000	-200		160	30		10		225	RAY	
	Triode	5	6	3000						60	Class C Telephony	2000	-200		160	30		10		225		
8K-39	Beam Triode	6.3	2.5	600	300	5	25	11.5	10	6.2	Class B Audio	600	-52		265	39		5.8	16000	350		
	Triode	6.3	2.5	600						60	Class C Telephony	600	-90	200	93	5	10	.88		36	RAY	
	Triode	6.3	2.5	600						60	Class C Telephony	475	-50	250	85	2.5	9	.2		26		
8Y-40	Triode	7.5	2.25	1000	25	25	40	6.2	1.1	6.5	Class B Audio	1000	-30	300	200	20	.4	6660		80		
	Triode	7.5	2.25	1000						60	Class C Telephony	1000	-30		125	20	5		9000	195	10 Iron	
	Triode	7.5	2.25	1000						60	Class C Telephony	850	-90		125	15	3.5		82			
	Triode	7.5	2.25	1000						60	Class B Audio	1000	-22.5		250	250				195		
8Y-42Z	Triode	7.5	2.5	1000	20	30	40	6.2	1.1	6.5	Class C Telephony	1000	-27.5		125	25	5			34		
	Triode	7.5	2.5	1000						60	Class C Telephony	1000	-30		125	30	7		9000	185	10 Iron	

For other characteristics, refer to 1021

Same as 35T except grid lead through envelope side

T-40	Triode	7.5	2.5	4-Pin	1500	150	25	40	40	4.5	0.8	4.8	60	Class C Telegraphy	1500	-140	150	22	9	158	Raytor	
TZ-40	Triode	7.5	2.5	4-Pin	1500	150	62	45	40	4.8	0.8	5.0	60	Class C Telegraphy	1500	-50	115	20	5.25	134	Raytor	
RK-41	Beam Triode	2.5	2.4	5-Pin	600	100	300	5	25	3.5	15	10	0.2	Class B Audio	1500	-20	55	3	10	36	RAY	
RK-42	Triode	1.5	.06	4-Pin	180	7.5	2			3	2.1	6		Class A Audio	180	-15.5	5.9	2.5	.2	26	RAY	
RK-43	Beam Triode	1.5	.12	6-Pin	135	15	15	3		1.9	2.1	4.2		Class C Telegraphy	135	-20	14	3	.2	125	RAY	
RK-44	Pentode	12.0	.7	7-Pin	500	80	200	9	12	8	16	10	0.2	Class C Telegraphy	500	-75	60	4	15	22	RAY	
RK-45	Pentode	12.6	.35	7-Pin	500	60	250	10	10	10	10	0.02		Class C Telegraphy	500	-90	43	6	30	13.5	RAY	
RK-46	Pentode	12.0	2.5	5-Pin	1250	92	300	15	40	15	14	12	0.1	Class C Telegraphy	1250	-100	92	11.6	1.6	34	RAY	
RK-47	Beam Triode	10	5.25	5-Pin	1250	150	300	10	50	10	13	10	0.12	Class C Telegraphy	1250	-70	138	7	14	120	RAY	
RK-48	Beam Triode	10	5	5-Pin	2000	180	400	25	100	22	17	15	0.15	Class C Telegraphy	2000	-120	90	7.5	23	55	RAY	
RK-49	Beam Triode	6.3	.9	6-Pin	400	100	300	6	21	3.5	11.5	10.6	1.4	Class C Telegraphy	400	-50	55	3	8	25	RAY	
UH-50	Triode	7.5	3.25	4-Pin	1250	125	15	25	50		2.2	2.4	60	Class C Telegraphy	1250	-225	125	20	7.5	115	FMW	
50-T	Triode	5	6	4-Pin	3000	100	12	30	75		2.0	0.4	2.0		Class C Telegraphy	3000	-600	100	25	10	115	FMAC
UH-51	Triode	3	6.5	4-Pin	2000	175	10.0	25	50		2.2	0.3	2.0	60	Class C Telegraphy	2000	-500	150	20	15	225	FMAC
HY-51A	Triode	7.5	3.5	4-Pin	1000	175	25	25	65		7.1	1.1	7.0		Class C Telegraphy	1000	-75	175	20	7.5	131	Hytron
HY-51B	Triode	10	2.25	6										Class C Telegraphy	800	-7.5	150	15	7.5	104	Hytron	
HY-51Z	Triode	7.5	3.5	4-Pin	1000	175	85	35	65		7.1	1.1	7.0	Class B Audio	1250	0	300		5	9000	225	Hytron
RK-51	Triode	7.5	3.75	4-Pin	1500	150	20	40	80		6	2.5	6		Class C Telegraphy	1500	-250	150	31	10	170	RAY
RK-52	Triode	7.5	3.75	4-Pin	1500	130	150	50	62.5		6.6	2.4	12		Class C Telegraphy	1500	-120	130	40	7	135	RAY
SG-4	Triode	5	12.5	55	15000		55		55		3.4	0.4	1.5	Oscillator at 3000 KC.	1250	0	300	100	7.5	10000	250	FMW
HK-54	Triode	5	5	4-Pin	3000	135	27	20	50		1.5	6.2	1.5	220	Class C Telegraphy	2000	-200	190	20	9	210	RAY
														Class C Telegraphy	1500	-45	198		8	200	RAY	

MFR. NO.	TYPE	HEATER OR FILAMENT		BASE	MAX. PLATE VOLTAGE	MAX. PLATE CURR. (MA.)	TRIODE OR MAX. SCREEN VOLTAGE (VOLTS)	MAX. DC CONTROL GRID CURR. (MA.)	MAX. PLATE DISSIPATION (WATTS)	INTERELECTRODE CAPACITANCES (P-F)		MAX. FREQ. RATING (MC.)	TYPICAL OPERATION	PLATE VOLTS	CON-TROL GRID BIAS (VOLTS)	SCREEN VOLTS	SUP-PRESOR VOLTS	PLATE CURR. (MA.)	D.C. CONTROL GRID CURR. (MA.)	SCREEN CURR. (MA.)	GRID DRIVING POWER APPROX. TO P (WATTS)	LOAD IMPEDANCE (OHMS)	POWER OUTPUT TYPICAL (WATTS)	MFR. C
		IN-PUT	OUT-PUT							G-F	F-F													
T-55	Triode	7.5	3	4-Pin	1500	166	20	40		4.55	1.15	5.85	Class C Telegraphy	1500	-140			165	20		5.6		153.5	RAY
RK-56	Tetrode	6.3	.55	5-Pin	300		300		8	16	0.2	60	Class C Telegraphy	400	-40	300		62	1.6	12	.1		12.5	RAY
HY-57	Pentode	5.0	5.0	Special 25	3000	150	500	15	50	7.5	3.1	200	Class C Telegraphy	3000	-175	450	0	100	1	2	0.16		250	RAY
HY-57	Triode	6.3	2.25	4-Pin	850	110	50	25	40	4.9	1.7	60	Class C Telegraphy	760	-45			110	15		2.5		70	RAY
RK-57	Triode	10	3.25	4-Pin Giant																				RAY
RK-58	Triode	10	3.25	4-Pin Giant 20	1250	175		70	100	8.5	10.5	30	Class C Telegraphy	1000	-135			150	30		6		130	RAY
RK-59	Triode	6.3	1.0	4-Pin	500	90	25	25	15	5	1	3	Class C Telegraphy	500	-60			90	14		1.3		32	RAY
T-60	Triode	10	2.5	4-Pin	1600	150	20	60	60	5.5	2.5	30	Class C Telegraphy	1500	-150			150	9				100	RAY
RK-60	Hi-Vacuum Rectifier	5	3	4-Pin 2 Inverse Peak	2120	250							Full-wave Rectifier	750				250	Average					RAY
HY-60	Beam Tetrode	6.3	0.5	5-Pin	425	60	225	5	15	10	8.5	60	Class C Telegraphy	425	-15	225		60	2	7	.25		16	RAY
HY-61	Beam Tetrode	6.3	0.9	5-Pin	600	100	300	5	25	11	7	60	Class C Telegraphy	600	-50	250		100	3	9	.22		40	RAY
HY-63	Beam Tetrode	2.5 1.25	.125 .225	7-Pin	250	25	180	2	3	9.5	7.4	60	Class C Telegraphy	250	-35	195		20	2	3	.2		27.5	RAY
RK-63	Triode	5	10	4-Pin Giant	3000	250	37	60	200	2.7	1.1	3.3	Class C Telegraphy	3000	-200			233	45		17		525	RAY
RK-64	Pentode	6.3	0.5	5-Pin	400		100		6	10	9	60	Class C Telegraphy	400	-30	100	30	35	3	10	.18		10	RAY
U-65A	Beam Tetrode	6.0	3.5	Special 96	3000	150	400	20	85	8.0	2.1	50	Class C Telegraphy or PA	1500	-75	250		125	12	25	1.6		138	RAY
HY-65	Beam Tetrode	6.3	.8	7-Pin	450	63	250	6	10	9.5	7.4	60	Class C Telegraphy	360	-45	200		63	3	7	.5		19	RAY
RK-65	Tetrode	5	14	4-Pin Giant	3000		500		215	10.5	4.75	0.24	Class C Telegraphy	3000	-100	400		240	24	70	6		510	RAY
RK-66	Tetrode	6.3	1.5	5-Pin	600		300		30	12	10.5	0.25	Class C Telegraphy	500	-50	300		90	5	11	.5		40	RAY

For other characteristics, refer to 945.

MFR. NO.	TYPE	HEATER OR FILAMENT		BASE	MAX. PLATE VOL-TAGE	MAX. CUR-RENT (MA)	TRIODE OR MAX. SCREEN VOLTAGE	MAX. DC CONTROL GRID CUR-RENT (MA)	MAX. PLATE DISSIPATION (WATTS)	INTERELECTRODE CAPACITANCES (P.F.)			TYPICAL OPERATION	PLATE VOLTS	CON-TROL GRID BIAS (VOLTS)	SCREEN VOLTS	SUP-PRES-SOR VOLTS	PLATE CUR-RENT (MA)	D.C. CON-TROL GRID CUR-RENT (MA)	SCREEN CUR-RENT (MA)	GRID DRIVING POWER APPROX P TO P (WATTS)	LOAD IM-PED-ANCE (OHMS)	POWER OUTPUT (WATTS)	MFR.
		G-F	F-F							G-P														
F-127A	Triode	10	4	4-Pin Giant 25	3000	325	38	70	200	13	13	4	Class C Telegraphy	3000	-250	250	250	47	18	18	600	600	PTD.	
V1-127A	Triode	5	10.5	Baseless 55	16000		15		170				Class C Telegraphy	2000	-540	210	210	65	25	25	315	315		
F-128A	Triode	11	13	Special 55	3500	1000	36	175	700	12	4.5	15.5	Class C Telegraphy	3500	-400	854	854	107	73	73	2660	2660	PTD.	
HF-130	Triode	10	3.25	4-Pin Giant	1250	210	12.5		125		9		Class C Telegraphy	1250	-210						170	170	AMP.	
HF-140	Triode	10	3.25	4-Pin Giant	1250	175	12		100		12.5	15	Class C Telegraphy	1250			175				150	150	AMP.	
GL-146	Triode	10	3.25	Special Large 4-Pin 6	1500	175	78	60	125	7.2	3.9	9.2	Class C Telegraphy	1000	-200	160	160	40			100	100	G.F.	
HF-150	Triode	10	3.25	4-Pin Giant	1500	210	12.5		125		7.2	30	Class C Telegraphy	1500			210				200	200	AMP.	
TH-150	Triode	10	4.1	4-Pin Giant 13	3000	200	35	60	150	3.9	3.8	2	Class C Telegraphy	3000	-170	200	200	45	17	17	470	470	TAJ/OT	
150-T	Triode	5	10	4-Pin Giant 13	3000	200	13	50	150	3	0.5	3.5	Class C Telegraphy	3000	-600	200	200	35			450	450	ETMAC	
4X150A	Tetrode	6	2.8	8-Pin Loktal 65	1000	250	4.5		150	12.1	4.6	0.02	Class C Telegraphy	1000	-150	300	300	7	43	1-12	162	162	ETMAC	
6L-152	Triode	10	3.25	Special 4-Pin Large 6	1500	175	25	60	125	7	4	8.8	Class C Telegraphy	1250	-150	180	180	30			150	150	G.F.	
152-TH	Triode	5	12.5	4-Pin Special 79	3000	450	20	85	150	5.7	0.8	4.8	Class C Telegraphy	3000	-300	250	250	70	27	3	600	600	ETMAC	
152-TL	Triode	10	6.25	4-Pin Special 79	3000	450	12	75	150	4.5	0.7	4.4	Class C Telegraphy	3000	-150	335	335				700	700	ETMAC	
HK-154	Triode	5	6.5	4-Pin 5	1500	175	6.7	30	50	4.3	1.1	5.9	Class C Telegraphy	1500	-580	167	167	20	15		200	200	HK	
HK-158	Triode	12.0	2.5	4-Pin 5	2000	200	25	40	50	4.7	1	4.6	Class C Telegraphy	2000	-140	105	105	25	6		170	170	HK	
6L-159	Triode	10	9.6	Special Large 4-Pin 6	2000	400	20	100	250	11	5	17.6	Class C Telegraphy	2000	-200	400	400	17	6		620	620	G.E.	
6L-169	Triode	10	9.6	Special Large 4-Pin 6	2000	400	85	100	250	11.5	4.7	19	Class C Telegraphy	1500	-100	400	400	42	10		450	450	G.F.	
HF-175	Triode	10	4	4-Pin Giant	2000	250	18		125		6.3	30	Class C Telegraphy	2000	-18	250	250				300	300	AMP.	

Two parallel connected T1's in one envelope

MFR. NO.	TYPE	HEATER OR FILAMENT		BASE	MAX. PLATE VOLTAGE (VOLTS)	MAX. DC CONTROL GRID CURRENT (MA)	MAX. SCREEN CURRENT (MA)	MAX. PLATE CURRENT (MA)	INTERELECTRODE CAPACITANCES (P.F.)		MAX. FULL-RATING (MC.)	TYPICAL OPERATION	PLATE VOLTS	CON-TROL GRID BIAS (VOLTS)	SCREEN VOLTS	SUP-PRES-SOR VOLTS	PLATE CURRENT (MA)	D.C. CONTROL GRID CURRENT (MA)	SCREEN CURRENT (MA)	GRID DRIVING POWER APPROX TO P (WATTS)	LOAD IMPEDANCE (OHMS)	POWER OUTPUT TYPICAL (WATTS)	MFR. NO.
		G-F IN-PUT	F-P OUT-PUT						G-B FEED BACK														
Z-25	Mercury Vapor Rectifier	2.5	5	4-Pin	1000 Inverse Peak			1000 Inverse Peak			200	Half-Wave Rectifier				250 Average							
Z27-A	Triode	10.5	10.6	55	15000	30			3.25	0.3	2.45	oscillator at 300 MF.										75	
WE-241-B	Triode	14	6	3-Pin Special																			
242-C	Triode	8	3.25	4-Pin Giant	1250	12.5	50	150	6.1	1.7	1.7	Class C Telegraphy	1250	-225			150	20	7			130	W.F.
242-C	Triode	8	3.25	4-Pin Giant	1250	12.5	50	150	6.1	1.7	1.7	Class C Telegraphy	1000	-260			150	35	14			100	W.F.
242-C	Triode	8	3.25	4-Pin Giant	1250	12.5	50	150	6.1	1.7	1.7	Class B Audio	1250	-95			300	8				200	W.F.
249-B	Mercury Vapor Rectifier	2.5	7.5	4-Pin	1000 Inverse Peak			1500 Inverse Peak				Half-Wave Rectifier					375						
T-249-B	Rectifier																						
HF-250	Triode	10.5	4	4-Pin Giant	2500	18		150		5.8	20	Class C Telegraphy	2500				200					375	AMP.
250-TH	Triode	5	10.5	4-Pin Giant	3000	37	100	250	5.5	3.7	4.3	Class C Telegraphy	3000	-210			330	75	99			750	FDMAC
250-TH	Triode	5	10.5	4-Pin Giant	3000	37	100	250	5.5	3.7	4.3	Class C Telegraphy	3000	-210			330	75	99			750	FDMAC
250-TL	Triode	5	10.5	4-Pin Giant	4000	14	50	250	3.7	0.7	3.1	Class B Audio	1250	-175			500	17		3280		540	FDMAC
4-250-A	Beam Tetrode	5	14.5	5-Pin	4000	600	30	250	3.7	0.7	3.1	Class C Telegraphy	4000	-500			310	40	33			1000	FDMAC
4-250-A	Beam Tetrode	5	14.5	5-Pin	4000	600	30	250	3.7	0.7	3.1	Class C Telegraphy	4000	-600			330	45	99			750	FDMAC
4-250-A	Beam Tetrode	5	14.5	5-Pin	4000	600	30	250	3.7	0.7	3.1	Class B Audio	3000	-175			500	17		13000		1000	FDMAC
WE-251-A	Triode	10	16	Special Clips	3000	10.5		1000			30	Class C Telegraphy										1000	W.F.
HK-252-L	Triode	5	13	Special																			ARK
HK-253	Rectifier	5	10	6.5																			
HK-253-L	Rectifier	5	10	6.5	10000 Inverse Peak			1500 Inverse Peak				Half-Wave Rectifier					360 Average						
WE-253-A	Mercury Vapor Rectifier	2.5	3	2-Pin Special	3500 Inverse Peak			1000 Inverse Peak				Half-Wave Rectifier					250 Average						
HK-254	Triode	5	7.5	4-Pin Giant	4000	25	40	100	2.5	2.4	2.7	Class C Telegraphy	3000	-251			167	40	19			400	ARK
HK-254	Triode	5	7.5	4-Pin Giant	4000	25	40	100	2.5	2.4	2.7	Class B Audio	3000	-100			245	14		30000		550	ARK
WE-254-A	Tetrode	5	3.25	4-Pin	750	175	20	5	4.6	9.4	0.1	Class C Telegraphy	750	-90			60					25	W.F.
WE-254-B	Tetrode	7.5	3.25	4-Pin	750	150	25	4	11.2	5.4	0.85	Class C Telegraphy	750	-125			75					37.5	W.F.
HK-257	Beam Pentode	5	7.5	7-Pin Giant	3000	500	25	75	12.5	4.7	2.08	Class C Telegraphy	2000	-200			150	6	11			230	ARK
HK-257-B	Beam Pentode	5	7.5	7-Pin Giant	3000	500	25	75	12.5	4.7	2.08	Class C Telegraphy	1800	-130			135	8	1.7			178	ARK

For other characteristics, refer to 212F

For other characteristics, refer to 150-TI.

Model	Mercury Vapor Rectifier	2.5	7.5	2-Pin Special 74	7500 Inverse Peak	2500 Peak	12.5	50	125								640 Average	W.F.			
WE-258-B	Diode	10	3.25	4-Pin Giant 12	1250	210	12.5	50	125		5.5	3.5	9	30	Class C Telegraphy	1250	-250	200	10	3.5	170
261-A	Triode			4-Pin Giant 12											Class C Telephony	1250	-300	166	8	3.5	148
F-266-B	Mercury Vapor Rectifier	5	30	Special Clips	22000 Inverse Peak	40000 Peak									Class B Audio	1250	-90	400		4.5	320
WE-267-B	Mercury Vapor Rectifier	5	6.75	2-Pin Special 74	7500 Inverse Peak	4000 Peak									Half-Wave Rectifier			10000 Average			
WE-268-A	Triode	5	3.25	4-Pin 6	750	60	5		25					30	Class C Telegraphy						
WE-270-A	Triode	10	9.75	Special 16	3000	375	16	75	350		18	2	21	7.5	Class C Telegraphy	3000	-375	350	70	37	700
WE-276-A	Triode	10	3	4-Pin Giant 12	1250	125	12	50	100		6	4	9	30	Class C Telephony	2250	-300	300	70	32	450
WE-276-A	Triode	10	3	4-Pin Giant 12	1250	125	12	50	100		6	4	9	30	Class B Audio	2000	-105	750		75	850
WE-279-A	Triode	10	21	Special Clips	3000	800	10		1200						Class C Telegraphy	1250	-225	125	20	7	100
WE-282-A	Triode	10	2	4-Pin Giant 9	1000	100	150	50	70		5	12.2	6.8	0.2	Class C Telephony	1000	-150	100		150	67
WE-284-D	Triode	10	3.25	4-Pin Giant 12	1250	150	4.8	100	85		6	5.6	8.3		Class C Telephony	1250	-500	150	25		125
WE-295-A	Triode	10	3.25	4-Pin Giant 12											Class A Audio	1250	-200	64			40
HF-300	Triode	11	4	4-Pin Giant 13	3000	275	23	60	200		6	1.4	6.5	60	Class C Telegraphy	2000	-200	275	36	13	410
WE-300-B	Triode	5	1.2	4-Pin 3	450	100	3.8		40		9	4.3	1.5		Class C Telephony	2000	-300	250	36	17	385
WE-301-A	Mercury Vapor Rectifier	5	3	4-Pin 51	1800 Inverse Peak	2000 Peak									Class R Audio	2000	-72	480		14	9600
303-A	Triode	10	3.25	4-Pin Giant 12											Class A Audio	450	-97	80			14.6
304-A	Triode	11	3.85	Special 16											Full-Wave Rectifier			1000 Average			
304H	Triode	5	25	4-Pin Giant 79	3000	900	20	170	300		13.5	0.7	10.2	40	Class C Telegraphy	3000	-300	500	135	53	1200
304-L	Triode	5	25	4-Pin Special 79	3000	900	12	150	300		8.5	0.6	9.1	175	Class B Audio	3000	-150	667	6	10/200	1400
WE-305-A	Triode	10	3.1	4-Pin 3	1000	125	200	40	60		6	10.5	5.4	0.14	Class C Telephony	2000	-400	500	90	70	800
305-D	Triode	4.5	1.6	4-Pin 3											Class A ₂ Audio	1600	-150	600		1.8	4500

For other characteristics, refer to 270-A

For other characteristics, refer to 294-A

For other characteristics, refer to 294-A

For other characteristics, refer to 294-F

MFR. NO.	HEATER OR FILAMENT TYPE	HEATER (VOLTS)(AMP.)	MAX. PLATE VOLTAGE	MAX. PLATE CURRENT	TRIODE OR MAX. SCREEN VOLTAGE	MAX. DC CONTROL GRID CURRENT	MAX. PLATE DISSIPATION	INTERELECTRODE CAPACITANCES		MAX. FREQ. FULL RATING	TYPICAL OPERATION	PLATE VOLTS	CON-TROL GRID BIAS	SCREEN VOLTS	SUP-PRES-SOR VOLTS	PLATE CURRENT	D.C. CON-TROL GRID CUR-	SCREEN CUR-RENT	GRID DRIVING POWER APPROX P TO F	LOAD IM-PED-ANCE	POWER OUTPUT TYPICAL	MFR. NO.
								G-F IN-PUT	P-F OUT-PUT													
ME-306-A	Pentode	2.75	300	300	300		15	6	13	13	0.35	Class C Telephony	300	-50	180	36	3	15			7	W.E.
ME-307-A	Pentode	5.5	500	60	250	7	15	6	15	12	0.55	Class C Telephony Sup. Mod. Telephony	500 500	-35 -35	250 200	60 40	1.4 1.5	13 20			20 6	W.E.
ME-308-B	Triode	14	2250	325	8	75	250		13.6	9.3	17.4	1.5	1750 1250	-400 -320		300 300	75				350 250	W.E.
311	Triode	10																				United
For other characteristics, refer to 211																						
ME-312-A	Pentode	10	1250		500		50	20	15.5	12.3	0.15	Class C Telephony Class C Telephony Sup. Mod. Telephony	1250 1000 1250	-55 -40 -50	300	100 95 50	5.5 7 5	36 35 42	.7 1 .55		90 65 23	W.E.
312-E	Triode	14																				
For other characteristics, refer to 212E																						
315-A	Mercury Vapor Rectifier	5	12500 Inverse Peak	4000 Peak																		W.E.
ME-316-A	Triode	2	450	80		12	30		1.2	0.8	1.6	500				80					7.5	W.E.
ME-319-A	Mercury Vapor Rectifier	5	7500 Inverse Peak	4000 Peak																		W.E.
ME-321-A	Mercury Vapor Rectifier	5	12500 Inverse Peak	4000 Peak																		W.E.
322-A	Pentode	10																				
327-A	Triode	10.5	19000		30		100		3.4	0.3	2.25	200									75	
331-A	Triode	10																				
ME-333-A	Pentode	5	575	125	96		45															W.E.
312-B	Triode	10																				
ME-350-A	Tetrtode	6.3	600	125	430		30															
HK-354	Triode	5	4000	300	14	50	150		4.5	0.6	3.3	30										HK
HK-354C	Triode	5																				HK
For other characteristics, refer to HK-354																						

HK-354D	Triode	5	10	3500	300	22	55	150	4.5	1.1	3.8	30	Class C Telegraphy	3500	-480	240	50	38	680	HK
HK-354E	Triode	5	10	3500	300	35	60	150	4.5	1.1	3.8	30	Class B Audio	2500	-112	280	20	20000	519	HK
HK-354F	Triode	5	10	3300	330	50	75	150	4.5	1.1	3.8	30	Class C Telegraphy	3500	-448	240	60	45	680	HK
HK-354G	Triode	5	10	3300	330	50	75	150	4.5	1.1	3.8	30	Class B Audio	2000	-37.5	372	20	11000	472	HK
WE-356-A	Triode	5	5	1500	120	50	35	60	2.25	1	2.75	100	Class C Telegraphy	3500	-368	250	75	50	720	HK
WE-357-A	Triode	5	5	4000	500	30	350					100	Class B Audio	2500	-35	300	20	20000	550	HK
WE-363-A	Triode	10	10	4000	500	300	350					85	Class C Telegraphy							h. f.
WE-364-A	Triode	5	5	1500	120	50	50					150	Class C Telegraphy							h. f.
WE-367-A	Tetrode	6.3	1.6	400	125	400	25						Class C Telegraphy							h. f.
WE-368-A	Triode	1.15	4.5	350	75	8	20					1250	Class C Telegraphy							h. f.
WE-369-A	Triode	6.3	.75	400	20	45	3.75		2.2	0.02	1.6		Class C Telegraphy	250		25				G.E. RCA
460-TH	Triode	7.5	12	6000	600	38	125	450	8.8	0.8	5.0		Class C Telegraphy	5000	-300	450	90	46	1800	FTMAC
460-TL	Triode	7.5	12	5000	450	16	75	480	7.3	0.9	5.2		Class C Telegraphy	4000	-400	400	70	100	1250	FTMAC
464-H	Triode	5	10	5000	375	30	85	250	4.6	1.4	3.4	100	Class B Audio	5000	-115	620		10	18600	2200
464-L	Triode	5	10	5000	375	12	60	250	4.6	1.4	3.4	100	Class C Telegraphy	3500	-500	480	54	42	1800	FTMAC
464-A	Triode	6.3	.75	48									Class C Telegraphy	5000	-700	400	70	100	1250	2200
468	Triode	10	4	29									Class B Audio	5000	-240	620		15	18600	2200
469	Triode	10	3	12									Class C Telegraphy	3500	-275	270	60	28	760	HK
469A	Triode	5	10	5000	375	12	60	250	4.6	1.4	3.4	100	Class C Telegraphy	3500	-450	270	45	30	760	HK
469B	Triode	6.3	.75	48									Class C Telegraphy							West.
469C	Triode	10	4	29									Class C Telegraphy							G.E. RCA
469D	Triode	10	3	12									Class C Telegraphy							West.
469E	Beam Tetrode	5	13.5	4000	350	6.2	50	500	12.8	5.6	0.05	110	Class C Telegraphy	3000	-200	400	45	95	1180	FTMAC
527	Triode	5.5	135	20000		38	300		19	1.4	12	200	Oscillator at 300 MC.						250	
575-A	Mercury Vapor Rectifier	5	10	15000	6000								Half-Wave Rectifier			1500	Average			PCA

MFR. NO.	TYPE	HEATER OR FILAMENT		BASE	MAX. PLATE CUR-RENT (MA)	TRIODE OR MAX. SCREEN VOLTAGE (VOLTS)	MAX. DC GRID CUR-RENT (MA.)	MAX. DC PLATE DISSIPATION (WATTS)	INTERELECTRODE CAPACITANCES			MAX. FREQ. FULL-RATING (MC.)	TYPICAL OPERATION	PLATE VOLTS	CON-TROL GRID BIAS (VOLTS)	SCREEN VOLTS (VOLTS)	SUP-PRES-SOR VOLTS	PLATE CUR-RENT (MA.)	D.C. CON-TROL CUR-RENT (MA.)	SCREEN CUR-RENT (MA.)	GRID DRIVING POWER APPROX. TO P (WATTS)	LOAD IMPEDANCE (OHMS)	POWER OUTPUT TYPICAL (WATTS)	MFR. & G.	
		G-F IN-PUT	P-F IN-PUT						G-P FEED-BACK																
6L-592	Triode	10	5	No Base 88	350	24	50	300	3.6	0.41	3.3	110	Class C Telephony	3600	-250			350	45		18				G.E.
HY-615	Triode	6.3	.15	Oscul. 32	300	22	4	3.5	1.4	1.45	1.85	112	Class C Telephony	300	-35			20	1.4		.2		4.5		Hytron
HR-654	Triode	7.5	15	4-Pin Giant 13	4000	25	100	300	6.2	1.5	5.5	20	Class C Telephony	2500	-406			500	75		59		950		HRK
673	Mercury Vapor Rectifier	5	10	4-Pin Giant Inverse Peak 63	6000								Half-Wave Rectifier	1500	-45			643			50		675		RCA
4-750A	Tetode	7.5	20	Special	6000	700		750	26.85	7.78	0.24		Class C Telephony	6000	-700			625			93		3000		ETD/MC
750-7L	Triode	7.5	21	4-Pin Special 97	7500	35	125	1000	9.3	0.5	5.1		Class C Telephony	6000	-350			894			30	16300	3500		ETD/MC
756	Triode	7.5	2	4-Pin 3	850	8	25	40	3	2.7	7		Class C Telephony	500	-75			130			3	10000	46		RCA Hytron G.E.
800	Triode	7.5	3.1	4-Pin 5	1250	8	15	15	2.75	2.75	2.5	60	Class C Telephony	1250	-175			70	15		4		65		RCA G.E. West.
801 801-A	Triode	7.5	1.25	4-Pin 3	600	8	15	15	4.5	1.5	6	60	Class C Telephony	600	-150			65	15		4		25		RCA Hytron G.E.
802	Pentode	6.3	0.9	7-Pin 7	600	250	7.5	13	12	8.5	0.15	30	Class C Telephony	600	-120			55	2.4	16	.3		23		RCA G.E. West.
803	Pentode	10	5	5-Pin Giant 11	2000	600	50	125	17.5	29	0.15	20	Class C Telephony	2000	-90			160	12	45	2		210		RCA G.E.
804	Pentode	7.5	3	5-Pin 11	1500	300	15	50	16	14.5	0.01	15	Class C Telephony	1500	-100			100	7	35	1.95		110		RCA G.E. West.
805	Triode	10	3.25	4-Pin Giant 29	1500	46	60	125	8.5	10.5	6.5	30	Class C Telephony	1250	-160			160	60	16	16		140		RCA G.E. Taylor
806	Triode	5	10	4-Pin Giant 29	3300	12.6	50	225	5.5	0.4	4	30	Class C Telephony	3000	-670			300	40	34	34		780		RCA G.E. West
807	Beam Tetode	6.3	.9	5-Pin 30	750	300	5	30	11	7	0.2	60	Class C Telephony	750	-45			100	3.5	6	.2		50		RCA G.E. Ken.

808	Triode	7.5	4	4-Pin 5	1500	150	47	35	50		5.3	0.25	2.8	30	Class C Telegraphy	1500	-200	125	30	9.5	140	RCA
809	Triode	6.3	2.5	4-Pin 6	1000	100	50	35	30		5.7	0.9	6.7	60	Class C Telegraphy	1000	-75	100	25	3.8	105	RCA G.E. Ken. West.
810	Triode	10	4.5	4-Pin Giant 29	2750	300	36	75	175		8.7	12	4.8	30	Class C Telegraphy	2500	-180	300	60	19	575	RCA
811	Triode	6.3	4	4-Pin 6	1500	150	160	50	55		5.5	0.6	5.5	60	Class C Telegraphy	1500	-113	125	50	11	120	G.E.
812	Triode	6.3	4	4-Pin 6	1500	150	29	35	55		5.3	0.8	5.3	60	Class C Telegraphy	1500	-175	150	25	6.5	170	RCA
812-H	Triode	6.3	4	4-Pin 6	1750	200	29	45	300		5.3	0.8	5.3	30	Class C Telegraphy	1750	-175	170	26	6.5	225	West. G.E.
813	Beam Tetrode	10	5	7-Pin 28	2250	225	400	25	100		16.3	14	0.2	30	Class C Telegraphy	2250	-155	220	15	40	375	RCA
814	Beam Tetrode	10	3.25	5-Pin 10	1500	150	300	15	65		13.5	13.5	0.1	30	Class C Telegraphy	1500	-90	150	10	24	160	West. G.E.
T-814	Triode	10	4	4-Pin Giant 29											Class C Telegraphy	1250	-150	144	10	20	130	RCA
815	Twin Beam or Tetrode	6.3 or 12.6	.8 Unit	8-Pin 27	500	150	200	10	25		14	8.5	0.2	125	Class C Telegraphy	500	-45	150	3.5	17	56	RCA
816	Mercury Vapor Recti- fier	2.5	2	4-Pin 1	5000 Inverse Peak	500									Class C Telegraphy	400	-45	150	3	15	46	G.E.
T-822	Triode	10	4	4-Pin Giant 29											Half-Wave Rectifier			125 Average				RCA
826	Triode	7.5	4	Special 34	1000	125	31	35	60		3.7	1.4	2.9	250	Class C Telegraphy	1000	-70	125	35	5.8	86	RCA
827-R	Beam Tetrode	7.5	25	Special 35	3500	500	1000	150	800		21	13	0.18	127	Class C Telegraphy	3500	-300	428	100	50	1050	RCA
828	Beam Pentode	10	3.25	5-Pin 10	2000	180	750	15	80		13.5	14.5	0.05	30	Class C Telegraphy	1500	-100	180	12	28	200	RCA
829-8	Twin Beam Tetrode	6.3 12.6	2.25 1.12	Special 24 9	750	240	225	15	40		14.5	7	0.1	200	Class C Telegraphy	1250	-140	160	12	28	150	West.
830	Triode	10	2	4-Pin 3	750	110	8	18	40		4.9	2.2	9.9	15	Class C Telegraphy	750	-180	110	15	5	55	RCA
															Class C Telegraphy	600	-220	100	15	6.5	50	United
															Class B Audio	750	-85	110			102	United

MFR. NO.	TYPE	HEATER OR FILAMENT		BASE	MAX. PLATE VOLTAGE	MAX. CURR. PLATE	TRIODE OR MAX. SCREEN VOLTAGE	MAX. DC. CONTROL GRID CURR.	MAX. PLATE DISSIPATION	INTERELECTRODE CAPACITANCES		MAX. FREQ. FULL-RATING	TYPICAL OPERATION	PLATE VOLTS	CON-TROL GRID BIAS	SCREEN SUP-PRESOR VOLTS	PLATE CURR. (MA.)	D.C. CON-TROL GRID CURR. (MA.)	SCREEN CURR. (MA.)	GRID DRIVING POWER (WATTS) APPROX TO P	LOAD IMPEDANCE	POWER OUTPUT (WATTS) TYPICAL	MFR.
		(VOLTS)	(AMP.)							G-F (P-P) IN-PUT	OUT-PUT												
830-B	Triode	10	2	4-Pin 6	1000	150	25	30	60	5	1.8	11	Class C Telegraphy	1000	-110		140	30	7			90	RCA
832-A	Tri. Beam Tetrode	6.3 12.6	1.6 0.8	Special 24 8	750	90	250	6	15	7.5	3.8	0.05	Class C Telegraphy	750	-65	200	48	2.8	15	.19	7600	26	RCA
833-A	Triode	10	10	Special 36	4000	500	35	100	450	12.3	8.5	6.3	Class C Telegraphy	4000	-225		500	95	35		1800	RCA	
834	Triode	7.5	3.1	4-Pin 5	1250	100	10.5	20	50	2.2	0.6	2.6	Class C Telegraphy	1250	-225		90	15	4.5		75	RCA	
835	Triode	10	3.25	4-Pin 12									Class C Telegraphy	1000	-310		90	17.5	6.5		58	G.E.	
836	RT- Vacuum Rectifier	2.5	5	4-Pin 1	5000 Inverse Peak	1000							Half-wave Rectifier				250 Average						RCA
837	Pentode	12.6	.7	7-Pin 7	500	50	200	8	12	16	10	0.2	Class C Telegraphy	500	-75	+10	60	4	.4		22	RCA	
838	Triode	10	3.25	4-Pin 12	1250	175	High	70	100	6.5	5	8	Class C Telegraphy	1250	-90	+10	150	30	6		130	R.C.A. G.E. Taylor	
841	Triode	7.5	1.25	4-Pin 3	450	60	30	20		4	3	7	Class C Telegraphy	450	-34		50	15	1.8		15	RCA	
841-A	Triode	10	2	4-Pin 6	1250	150	14.6	30	50	3.5	2.5	9	Class C Telegraphy	350	-47		50	15	2		11	Ray	
841-SM	Triode	10	2	4-Pin 6	1000	150	14.6	30	50				Class B Audio	1250	-5		114		3.6		28		
842	Triode	7.5	1.25	4-Pin 12	405		3		12	4	3	7	Class A Audio	425	-100		28				3	RCA	
843	Triode	2.5	2.5	5-Pin 4	450	40	7.7	7.5	15	4	4	4.5	Class C Telegraphy	450	-140		30	5	1		7.5	G.E.	
845	Triode	10	3.25	4-Pin 12	1250	120	5.3		100	6	6.5	13.5	Class C Telegraphy	350	-150		30	7	1.6		5	RCA	
848 848-H	Triode	11	5	Special 16	3000	350	19	35	400	17	3	33.5	Class A Audio	1250	-195		80				30	RCA	
850	Tetrode	10	3.25	4-Pin 15	1250	175	175	40	100	17	25	0.25	Class C Telegraphy	2500	-250		300	20	8		550	RCA	
851	Triode	11	15.5	Special 16	3000	1000	20.5	200	750	25.5	4.5	47	Class C Telegraphy	2000	-300		300	30	14		425	RCA	
													Class B Audio	3000	-135		650		16	6400	900	AMP.	
													Class C Telegraphy	1250	-150		160	35	10		130	RCA	
													Class C Telegraphy	2500	-250		900	100	45		1700	G.E. RCA	
													Class B Audio	3000	-135		1200		6	5600	2400	West.	

For other characteristics, refer to 281-A

852	Triode	10	3.25	10	150	12	40	100	1.9	1	2.6	30	Class C Telegraphy Class C Telegraphy	3000 2000	-600 -500	85 67	15 30	12 23	165 75	RCA
HK-854-H	Triode	7.5	12	600	600	30	110	450	8	0.5	4	125	Class C Telegraphy Class C Telegraphy Class B Audio	5000 4000 4000	-310 -285 -140	450 475 670	75 100	40 50 45	1820 1520 1970	RAK
HK-854L	Triode	7.5	12	600	600	14	80	450	6	0.5	5	125	Class C Telegraphy Class B Audio	5000 4000	-575 -315	450 660	45 65	40 58 45	1800 1520 1880	RAK
860	Tetrode	10	3.25	150	3000	300	40	100	7.75	7.5	0.08	30	Class C Telegraphy Class C Telegraphy	3000 2000	-150 -200	85 85	15 38	7 17	165 105	RCA West. G.E.
861	Tetrode	11	10	350	3500	500	75	400	14.5	10.5	0.1	20	Class C Telegraphy Class C Telegraphy	3500 3000	-250 -200	300 200	40 55	40 35	700 400	West. RCA G.E.
865	Tetrode	7.5	2	60	750	15	15	15	8.5	8	0.1	15	Class C Telegraphy Class C Telegraphy	750 500	-80 -120	40 40	5.5 9	1 2.5	16 10	G.E. RCA
866	Mercury Vapor Rectifier	2.5	5	10000 Inverse Peak	10000 Inverse Peak								Half-Wave Rectifier			250 Average				RCA and Duerra
866-B	Mercury Vapor Rectifier	5	5	8500 Inverse Peak	8500 Inverse Peak								Half-Wave Rectifier							
HY-866 JR	Mercury Vapor Rectifier	2.5	3	5000 Inverse Peak	5000 Inverse Peak								Half-Wave Rectifier			125 Average				Bytron
866	Mercury Vapor Rectifier	2.5	3	3500 Inverse Peak	3500 Inverse Peak								Half-Wave Rectifier			125 Average				Taylor
871	Mercury Vapor Rectifier	2.5	2	5000 Inverse Peak	5000 Inverse Peak								Half-Wave Rectifier			250 Average				RCA
872	Mercury Vapor Rectifier	5	7.5	10000 Inverse Peak	10000 Inverse Peak								Half-Wave Rectifier			1250 Average				RCA and Others
933-B	Triode	10	2																	
938	Triode	10	3.25																	
975-A	Mercury Vapor Rectifier	5	10	15000 Inverse Peak	15000 Inverse Peak								Half-Wave Rectifier			1500 Average				United
1000T	Triode	7.5	17	7500	7500	35	125	1000	9.3	0.5	5.1		Class C Telegraphy Class B Audio	6000 6000	-350 -135	667 1110	110	60 35	3000 4600	EDMAC
HY 1231-Z	Triode	12.6	1.5	500	500	45	30	30	5	1.9	5.5	60	Class C Telegraphy Class C Telegraphy Class B Audio	500 400 500	-150 -100 0	150 150 150	30 30 30	2.5 3.5 1.8	56 45 51	Bytron

For other characteristics, refer to 830-B

For other characteristics, refer to 838

MFR. NO.	TYPE	HEATER OR FILAMENT		BASE	MAX. PLATE VOLTAGE (VOLTS)	MAX. TRIODE OR MAX. SCREEN VOLTAGE (VOLTS)	MAX. DC CONTROL GRID CURRENT (MA.)	MAX. MAX. PLATE DISSIPATION (WATTS)	INTERELECTRODE CAPACITANCES (P.F.)		MAX. FULL-RATING FREQ. (MC.)	TYPICAL OPERATION	PLATE VOLTAGE (VOLTS)	CON-TROL GRID BIAS (VOLTS)	SCREEN VOLTAGE (VOLTS)	SUP-PRESOR VOLTAGE (VOLTS)	PLATE CURRENT (MA.)	D.C. CONTROL GRID CURRENT (MA.)	SCREEN CUR-RENT (MA.)	GRID DRIVING POWER APPROX. TO P (WATTS)	LOAD IMPEDANCE (OHMS)	POWER OUTPUT (WATTS)	MFR. C
		G-F IN-PUT	P-F OUT-PUT																				
HY 1288	Beam Tetrode	12.6	1.5	5-Pin 10	750	300	7.5	40	15.3	3	0.19	6	Class C Telegraphy	750	-70	300	120	4	12.5	.25	63	63	BYRON
1500T	Triode	7.5	2.4	4-Pin Special 98	8000	24	175	1500	9.9	1.5	7.2	40	Class B Audio	6000	-150		860	110		85	4500	4500	EDMAC
1802	Triode	7.5	1.25	4-Pin 3	450	8	15	15	4	3	7	6	Class C Telegraphy	450	-115		55	15	3.3	13	13	8	G.E.
1808	Triode	2.5	2.5	4-Pin 3	425	20	25	20	8.5	3	9	45	Class C Telegraphy	425	-200		95	25		3.5	8	20	RCA
1610	Penode	2.5	1.75	5-Pin 19	400	200	3	6	8.6	13	1.2	20	Class C Telegraphy	400	-50	150	22.5	1.5	7	.1	5	5	RCA
1613	Penode (Metal)	6.3	.7	7-Pin 47	350	275	5	10	6.5	13.5	0.26	45	Class C Telegraphy	300	-35	200	50	3.5	10	.22	9	9	RCA
1614	Beam Tetrode (Metal)	6.3	.9	7-Pin 47	375	300	5	21	10	12	0.4	80	Class C Telegraphy	375	-35	200	88	3.5	9	.18	17	17	G.E.
1616	Hi-Vacuum Rectifier	2.5	5	4-Pin 1	5500 Immense Peak								Half-Wave Rectifier				130 Average						RCA G.E.
1619	Beam Tetrode (Metal)	2.5	2	7-Pin 37	400	300	5	15	9.6	12.5	0.29	45	Class C Telegraphy	400	-55	300	75	5	10.5	.36	18.5	18.5	RCA
1623	Triode	6.3	2.5	4-Pin 6	1000	20	25	30	5.7	0.9	6.7	60	Class C Telegraphy	750	-85		100	17		2.5	55	55	RCA G.E.
1624	Beam Tetrode	2.5	2	5-Pin 10	600	300	5	25	11	7.5	0.25	60	Class C Telegraphy	600	-60	300	90	5	10	.43	35	35	RCA
1625	Beam Tetrode	12.6	.45	7-Pin 38									Class B Audio	750	-25		200			4	8400	100	RCA
1626	Triode	12.6	.25	5-Pin 39	250	5	8	5	3.2	3.4	4.4	30	Class C Telegraphy	250	-70		25	5		.5	4	4	RCA
1627	Triode	5	9	4-Pin Giant 29																			RCA
1628	Triode	3.5	3.25	Special Baseless	1000	23	15	40	2	0.4	2	500	Class C Telegraphy	1000	-65		50	15		1.7	35	35	RCA
1642	Twin Triode	6.3	.6	7-Pin 48																			EDMAC
2000T	Triode	10	25	4-Pin Special 98	6000	23	200	2000	12.7	1.7	8.5	40	Class B Audio	7000	-250		1860			75	8500	9000	EDMAC
3X 2500A3	Triode	7.5	48	Special	5000	20	500	2500	48	1.2	20	110	Class C Telegraphy	4000	-360		1600			237	5000	5000	EDMAC

5514	Triode	7.5	3	4-Pin 6	1500	175	145	60	65				7.8	1	7.9	60	Class C Telegraphy	200	RCA
5516	Beam Pentode	6	.7	8-Pin 67	600	30	250	6	15	5	5	8.5	6.5	0.12	0.12	80	Class C Telegraphy Class C Telegraphy Class AB ₂ Audio	32 22 67	RCA
5556	Triode	4.5	1.1	4-Pin 3	350	40	8.5	10	7				4	3	8.3	6	Class C Telegraphy Class C Telegraphy	6 4	RCA
5558	Mercury Vapor Rectifier-Clear	5	4.5	4-Pin 1000 Inverse Peak 80	15000	15000 Peak											Half-Wave Rectifier		RCA
5562	Beam Tetrode	6.3	3		2000	125	400	20	45			6.5	1.8	0.2	0.2	120	Class C Telegraphy Class C Telegraphy		Unlabeled
5588	Triode			Special	1000	300	23	200				13	0.32	6.5	6.5	120	Class C Telegraphy		RCA
7193	Triode	6.3	.3	8-Pin 32													For other characteristics, refer to 3522		
8000	Triode	10	4.5	4-Pin Giant 29	2250	275	16.5	40	150			5	3.3	6.4	6.4	30	Class C Telegraphy Class C Telegraphy Class B Audio	475 335 725	RCA
8001	Beam Pentode	5	7.5	7-Pin Giant 25	2000	150	500	25	75			11	5.5	0.1	0.1	75	Class C Telegraphy Class C Telegraphy Sup. Mod. Telegraphy	230 178 35	RCA
8003	Triode	10	3.25	4-Pin Giant 29	1350	250	12	50	100			5.8	3.4	11.7	11.7	30	Class C Telegraphy Class C Telegraphy Class B Audio	167 460	RCA
8005	Triode	10	3.25	4-Pin 6	1500	200	20	45	85			6.4	1	5	5	60	Class C Telegraphy Class B Audio	220 300	RCA
8008	Mercury Vapor Rectifier-Clear	5	7.5	4-Pin Inverse Peak 63	10000	5000 Peak											Half-Wave Rectifier		RCA
8010-R	Triode	6.3	2.4	Special	1350	150	30	20	50			2.3	0.07	1.5	1.5		Class C Telegraphy		G.E.
8012-A	Triode	6.3	1.92	Special Base-Less	1000	80	18	20	40			2.7	0.4	2.5	2.5	500	Class C Telegraphy Class C Telegraphy	35 22	G.E.
8013-A	Hi-Vacuum Rectifier-Clear	2.5	5	4-Pin Inverse Peak 1	40000	150 Inverse Peak											Half-Wave Rectifier		RCA
8020	Hi-Vacuum Rectifier-Clear	5	5.5	4-Pin Inverse Peak 1	40000	750 Inverse Peak											Half-Wave Rectifier		
8025-A	Triode	6.3	1.92	4-Pin 6V	1000	80	18	20	30			2.7	0.4	3.0	3.0	500	Class C Telegraphy Class C Telegraphy	35 22	RCA

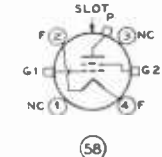
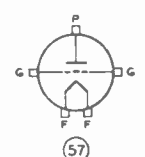
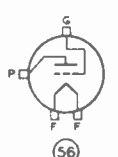
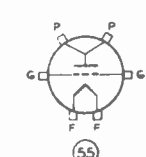
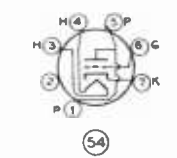
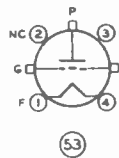
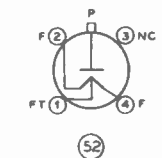
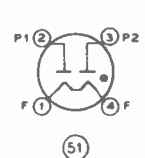
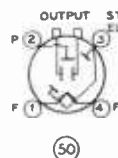
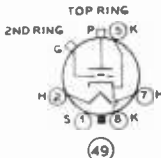
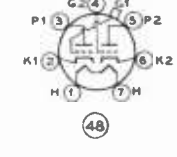
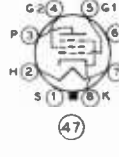
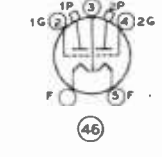
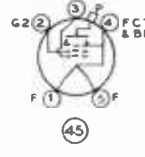
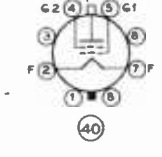
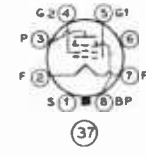
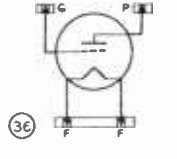
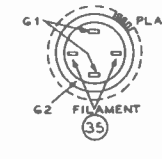
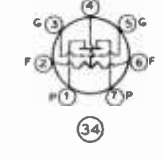
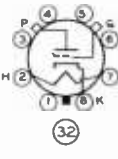
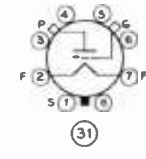
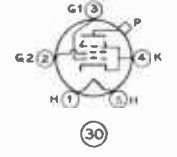
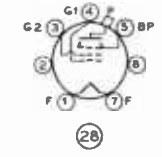
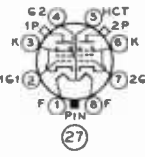
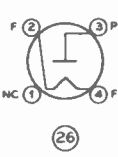
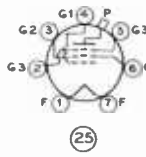
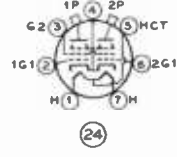
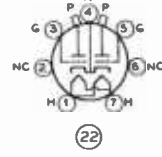
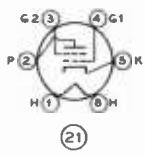
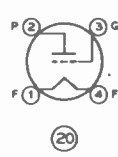
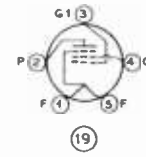
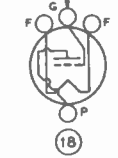
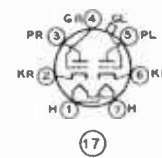
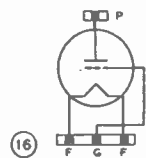
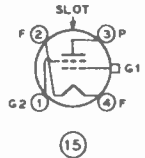
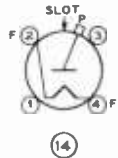
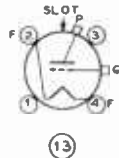
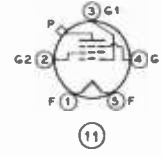
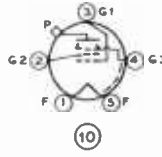
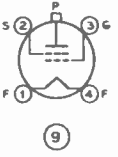
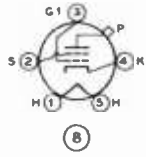
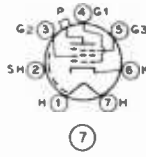
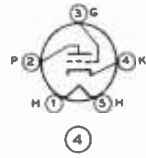
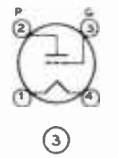
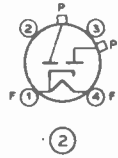
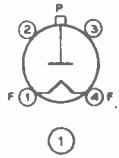

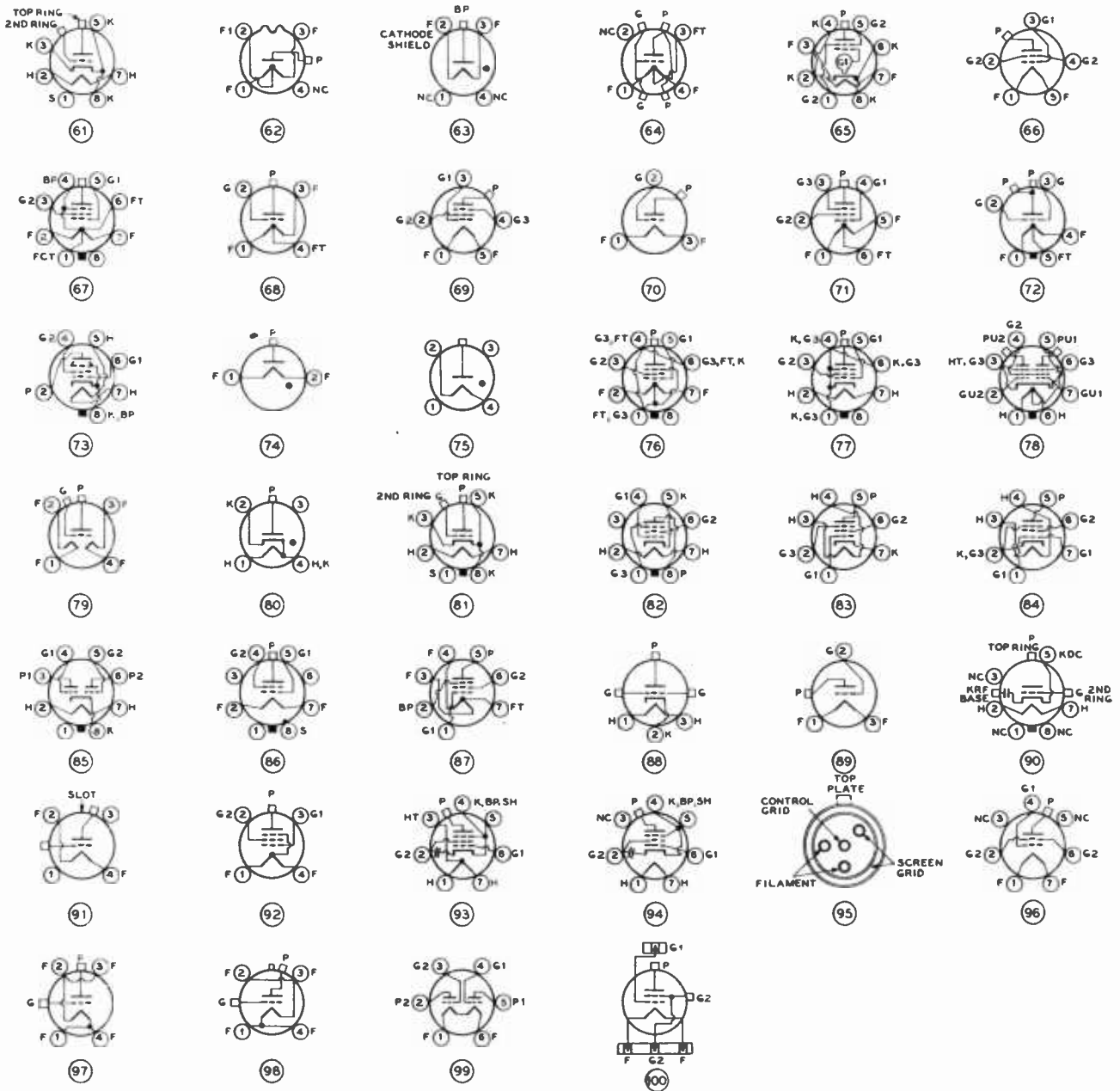

REFERENCES INDICATED IN TUBE TABLES

- ¹S—small; M—medium; L—large; O—octal. The final numbers in this column refer to socket connection diagrams.
- ²Plate-screen modulation is assumed in the Class-C Telephony application of tetrodes and pentodes.
- ³For Class-B and Class-AB Audio, plate current is the maximum signal value for two tubes.
- ⁴For Class-B and Class-AB Audio, grid current is the maximum signal value.
- ⁵Grid driving requirements for r.f. service are subject to wide variation depending upon impedance of the plate circuit.

- Values given are for typical plate impedances.
- ⁶Manufactured by the following: Amperex (Amp); Eimac; Federal Telephone and Radio Corp. (Fed.); General Electric (G.E.); Heintz & Kaufman (H & K); Hytron; Raytheon (Ray); RCA Manufacturing Co. (RCA); Taylor; United Electronics Co. (United); Westinghouse Electric Corp. (West).
- ⁷Grid connected to pins 2 and 3.
- ⁸Socket is provided with built-in by-pass capacitors.
- ⁹Cathode connected to pin 4.
- ¹⁰Bias must be adjusted at no signal for rated dissipation.
- ¹¹Triode connected, screen tied to plate.

High-Frequency Receiver Construction

THERE is a question as to whether or not it is wise to construct the communications receiver for use in an amateur station. Excellent commercial receivers are available on the market in all price range groups. Many of these receivers have been expressly designed for amateur communication, and to be able to equal their performance would require a very large expenditure of time and energy that might better be applied to work on the transmitter and its control system, or on antennas. Further, some excellent surplus receivers are available for all frequency ranges commonly used at prices far below the cost of the components in the receivers. Some of the aircraft receivers which cover only a single frequency range and

require only a simple rewiring of the heater circuits to operate from the simplest power supply are available at an extremely low price.

However, there is a considerable amount of satisfaction in having constructed one's own equipment. The intimate knowledge of circuits and the actual experience of having constructed an operable receiver are always of value to the experimentally inclined person. It is for this reason that we have included in this chapter constructional details on two receivers of a differing degree of complexity and for different frequency ranges. An adapter unit for obtaining FM reception of the narrow-band variety with any communications receiver having

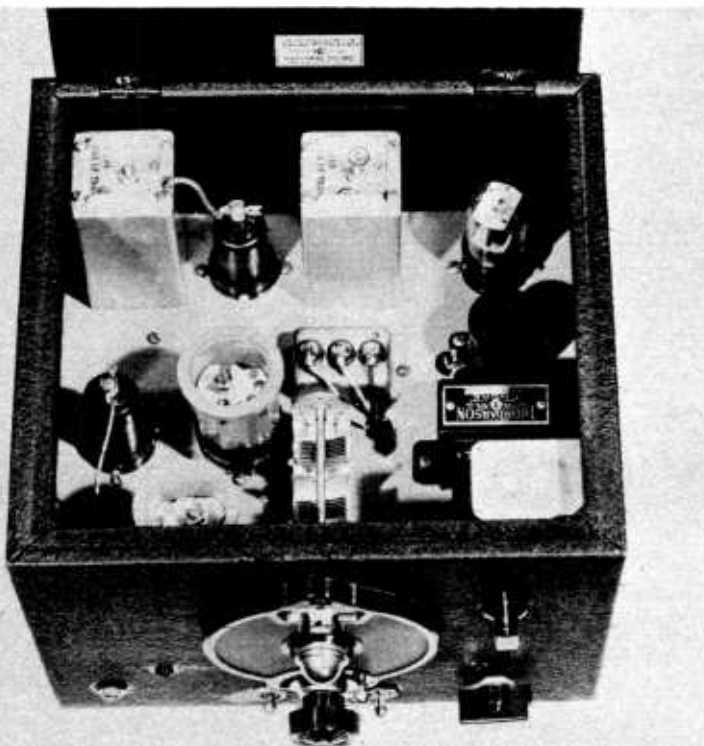

COIL TABLE				
Four-Tube Superheterodyne Receiver				
	Detector		Oscillator	
3.5 Mc.	L ₁	10 turns no. 18 close-wound	L ₁	16 turns no. 18 close-wound tapped 12 turns from ground
	L ₂	20 turns no. 18 close-wound tapped 15 t. from ground	L ₂	6 turns no. 18 close-wound
	C ₂	100-μfd. APC	C ₂₁	100-μfd. APC
7.0 Mc.	L ₁	6 turns no. 18 close-wound	L ₁	11 turns no. 18 spaced to 1" tapped 6 t. from gnd. end
	L ₂	14 turns no. 18 spaced to 1 1/4" tapped 7 t. from gnd. end	L ₂	6 turns no. 18 close-wound
	C ₂	100-μfd. APC	C ₂₁	100-μfd. APC
14 Mc.	L ₁	5 turns no. 18 close-wound	L ₁	7 turns no. 18 spaced to 1/2" tapped 2 1/2 t. from gnd. end
	L ₂	9 turns no. 18 spaced to 3/8" tapped 4 t. from gnd. end	L ₂	3 turns no. 18 close-spaced
	C ₂	50-μfd. APC	C ₂₁	50-μfd. APC

Figure 1.
TOP VIEW OF THE FOUR-TUBE RECEIVER.

an i-f in the 460-kc. range is also described. A "signal lifter" of the broad-band variety for improving the performance of an existing 28-Mc. or 50-Mc. receiver is described and constructional details are given.

FOUR-TUBE SUPERHETERODYNE RECEIVER FOR 3.5 AND 7 MC.

A receiver capable of dependable emergency or field-day operation combining the advantages of minimum power and space requirements with light weight and good stability is a valuable asset as a fixed-station standby receiver. The receiver to be described was designed with just these points in mind. Unlike most receivers of this sort it is unusually stable in operation because trick circuits such as regenerative i-f or regenerative detector circuits have been avoided. However, the overall gain is extremely high and 90 volts of plate supply is sufficient in most cases to give good headphone volume.

Almost any number of power sources can be employed due to the arrangement of the heater connections and the low "B" supply drain. Referring to Figure 3 it can be seen that with the series-parallel heater connection either 6 or 12 volt heater supply may be used. One of the surplus type 12-volt motor-generators operated on two 6-volt automobile storage batteries makes an ideal arrangement. Alternatively the receiver may use two 45-volt "B" batteries while an emergency transmitter may be supplied from the motor-generator.

Circuit of the Receiver The converter and amplifier are conventional in design. Both the oscillator and first detector portions of the 6K8 converter are tuned together by C₃ and C₂₀, thus eliminating the detuning effect due to pulling of the local oscillator when the two are tuned separately.

For the i-f amplifier, which uses a 6K7 tube, iron-core transformers of the type used in the BC-312 receiver were found

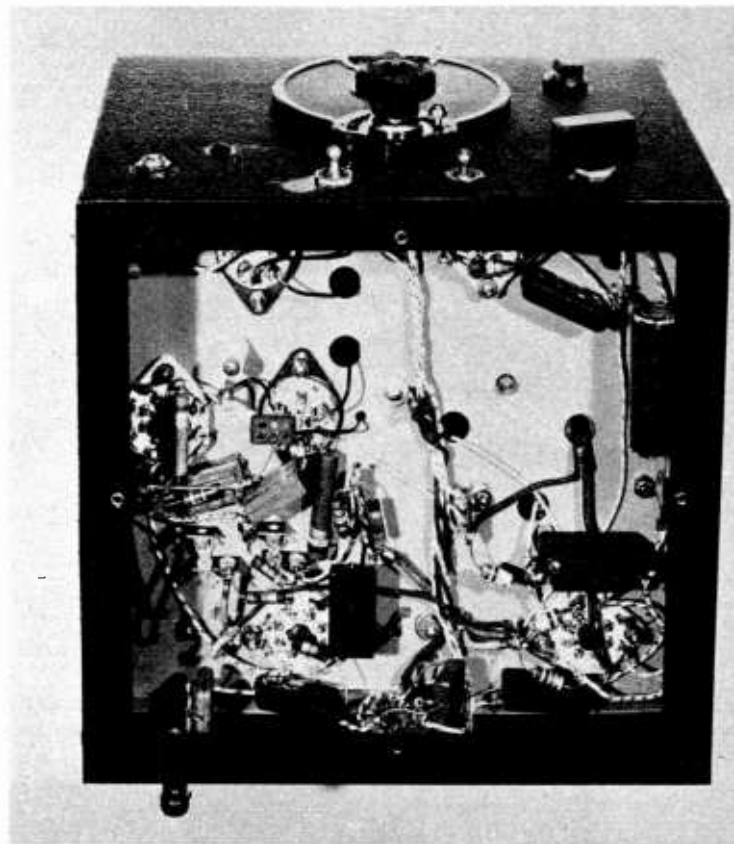

Figure 2. UNDERCHASSIS VIEW OF THE SIMPLE RECEIVER.

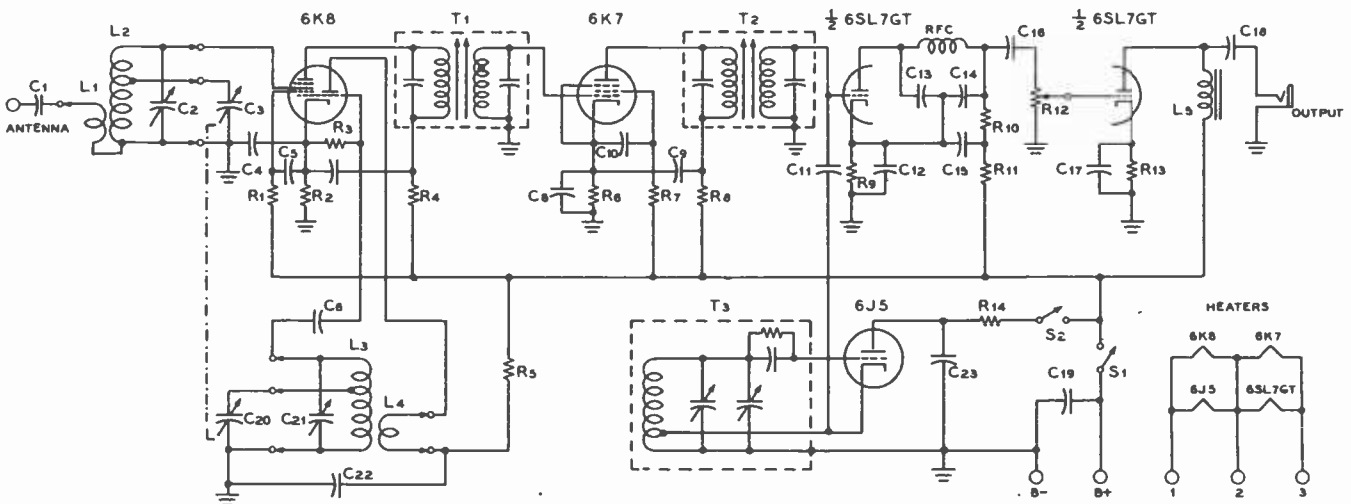

Figure 3.

SCHEMATIC DIAGRAM OF THE 4-TUBE 80-40 RECEIVER.

- | | | | |
|--|---|--|---|
| C ₁ —0.002- μ fd. midget mica | C ₁₁ —See text | R ₁ —25,000 ohms 1/2 watt | R ₁₁ —500,000-ohm potentiometer |
| C ₂ —APC across coil, see coil data | C _{12, C₁₇} —Dual 0.25- μ fd. bathtub | R ₂ —180 ohms 1/2 watt | R ₁₂ —5000 ohms 1/2 watt |
| C _{3, C₂₀} —50- μ fd. dual midget var. | C _{13, C₁₄} —0.00025- μ fd. mica | R ₃ —50,000 ohms 1/2 watt | R ₁₃ —100,000 ohms 1/2 watt |
| C _{4, C₅} —0.01- μ fd. 400-volt tubular | C _{15, C₁₆} —0.01- μ fd. 400-volt paper | R ₄ —200 ohms 1/2 watt | Coils—See coil table |
| C ₆ —100- μ fd. silver mica | C ₁₇ —25- μ fd. 25-volt tubular | R ₅ —10,000 ohms 2 watts | L—300-hy. 5-ma. choke |
| C ₇ —0.01- μ fd. 400-volt tubular | C ₁₈ —0.01- μ fd. 600-volt paper | R ₆ —200 ohms 1/2 watt | RFC—85-mh. r-f choke |
| C ₈ —0.05- μ fd. 400-volt tubular | C ₁₉ —0.002- μ fd. mica | R ₇ —250,000 ohms 1/2 watt | T _{1, T₂} —465-kc. iron-core inter-stage i-f transformers |
| C _{9, C₁₀} —0.01- μ fd. 400-volt tubular | C ₂₀ —See C ₃ | R ₈ —200 ohms 1/2 watt | T ₃ —465-kc. b-f-o transformer |
| C ₁₁ —0.01- μ fd. 400-volt tubular | C ₂₁ —See coil data | R ₉ —50,000 ohms 1/2 watt | S ₁ —S.p.s.t. plate switch |
| | C ₂₂ —0.01- μ fd. mica | R ₁₀ —100,000 ohms 1/2 watt | S ₂ —S.p.s.t. b-f-o switch |
| | C ₂₃ —0.01- μ fd. 400-volt paper | R ₁₁ —25,000 ohms 1/2 watt | |

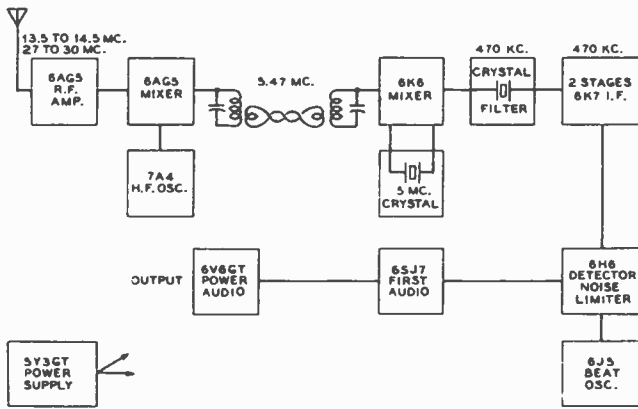

Figure 4.
BLOCK DIAGRAM OF THE DOUBLE-CONVERSION SUPERHETERODYNE.

on the surplus market. The use of these iron-core transformers helps account for the high sensitivity of the set. They are slug tuned and their adjustment is held by a locking nut. Standard manufactured 465-kc. iron-core i-f transformers can be used in place of the ones illustrated. A 6SL7-GT double triode serves both as second detector (plate detection) and as one stage of audio amplification.

The fourth tube, a 6J5, provides the beat frequency signal for c-w reception. Capacitor C₁₁, which may be just a few turns of wire around the second detector grid lead, feeds the signal into the second detector grid from the beat oscillator cathode. A little experimenting with the values of C₁₁ and R₁₁ will result in optimum signal-to-noise ratio for c-w reception. Coil data is given in the coil table.

Controls The receiver is built into a National SW-3 cabinet. On the front panel are the main tuning, beat-oscillator tuning and audio-gain control as well as two toggle switches for b-f-o and plate voltage control. A National type "B" dial is used for the main tuning with type HRP knobs for the b-f-o tuning and audio-gain controls.

The antenna connection and an octal power plug are mounted at the rear of the cabinet. With the octal plug extra connections such as audio output and a connection to the drop side of S₁, the B-switch, may be brought out for remote operation of the receiver.

The receiver may be operated on the 14-Mc. band, and coil data for this band is given in the coil table, but difficulty with

image responses will be encountered. The presence of images is the result of feeding the antenna directly into the mixer stage without an intermediate r-f amplifier and preselector stage.

DOUBLE-CONVERSION SUPERHETERODYNE FOR 14 AND 28 MC.

In designing a high-performance superheterodyne communications receiver for the 14-Mc. and 28-Mc. bands theory tells us that, from the standpoint of signal-to-noise ratio, it is necessary only to use a single r-f stage. The only reason for using more than one r-f stage in the conventional communications receiver is that the intermediate frequency is in the vicinity of 460 kc. and hence all the image rejection of the receiver must come from the r-f circuits. But if we convert first to a rather high value of intermediate frequency (5.47 Mc. is used in the receiver described) a single r-f stage will give adequate image rejection since the image will fall 10.94 Mc. away from the desired signal.

Now if we were to use the 5.47-Mc. channel as the only i-f amplifier of the receiver the set would be excessively broad and satisfactory operation of a crystal filter for c-w use would not be possible. So in the receiver described a second conversion is used to feed the second i-f amplifier channel on 470 kc. This second i-f channel is conventional in every respect and uses a standard 470-kc. crystal filter.

Block Diagram Figure 4 gives a block diagram of the complete receiver. A 6AG5 tube is used as a tuned r-f amplifier to feed a 6AG5 first detector. The h-f beating oscillator uses a 7A4 which is operated on the low side of the incoming signal to the receiver. The tuning capacitors for the oscillator, the r-f stage, and the first detector are grouped in a three-gang midget variable capacitor.

Shielded plug-in permeability-trimmed coils are used in all three of the high-frequency circuits of the receiver. The use of this type of inductor permits trimming of the slug position for tracking of the three tuned circuits over the desired frequency range. If the tapping points given in the coil table are used it will be possible to obtain accurate tracking of the receiver over both frequency ranges simply by adjustment of the tuning slugs in the inductors.

COIL TABLE		
DOUBLE-CONVERSION SUPERHETERODYNE FOR 10 AND 20.		
Band	R-F and Detector Coils	Oscillator Coils
28 Mc.	Secondary 12 turns no. 20 bare spaced to 3/4 inches. Tapped at 10 turns	Grid Coil 6 turns no. 20 bare spaced to 1/2 inch. Tuning capacitor across entire coil.
	Primary 5 turns no. 20 enam. close spaced. Separated 1/8" from secondary	Plate Coil 4 turns no. 20 enam. close spaced. Separated 1/8" from grid coil
14 Mc.	Secondary 20 turns no. 20 enam. spaced to 3/4 inches. Tapped at 16 turns	Grid Coil 7 turns no. 20 bare spaced to 1/2 inch. Tuning capacitor tapped 5 turns from ground end.
	Primary 7 turns no. 24 enam. close spaced. Separated 1/8" from secondary	Plate Coil 5 turns no. 20 enam. close spaced. Separated 1/8" from grid coil.

Figure 5.
TOP VIEW OF THE 10-20 DOUBLE-CONVERSION SUPER.



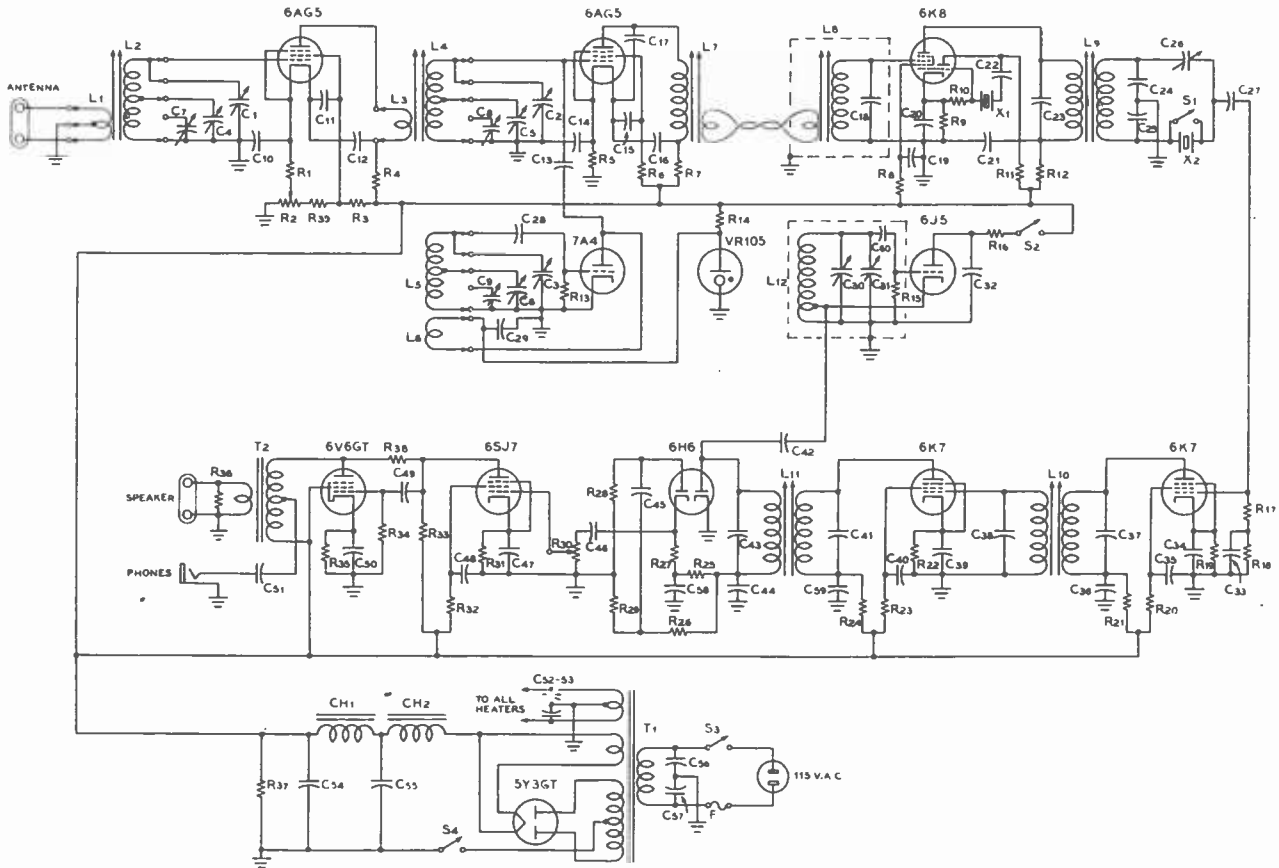

Figure 6.

SCHEMATIC DIAGRAM OF THE DOUBLE-CONVERSION SUPERHETERODYNE.

- | | | | |
|---|---|---|--|
| <p>C₁, C₂, C₃—3-gang 35-μfd. midget variable</p> <p>C₄, C₅, C₆—100-μfd. air padders</p> <p>C₇, C₈, C₉—50-μfd. air padders</p> <p>C₁₀, C₁₂, C₁₄, C₁₇—0.005-μfd. mica</p> <p>C₁₁, C₁₃—0.01-μfd. tubular</p> <p>C₁₅—5-μfd. midget mica</p> <p>C₁₆, C₁₈—50-μfd. silver mica</p> <p>C₁₉—0.02-μfd. 400-volt tubular</p> <p>C₂₀—0.1-μfd. 400-volt tubular</p> <p>C₂₁—0.01-μfd. 400-volt tubular</p> <p>C₂₂—0.002-μfd. mica</p> <p>C₂₃, C₂₄, C₂₅, C₂₆—Capacitors in i-f trans.</p> <p>C₂₇—0.006-μfd. mica</p> <p>C₂₈—50-μfd. midget mica</p> <p>C₂₉—0.005-μfd. mica</p> <p>C₃₀, C₃₁—Capacitors in b-f-o trans.</p> <p>C₃₂—0.01-μfd. 400-volt tubular</p> <p>C₃₃, C₃₄, C₃₅, C₃₆—0.1-μfd. 400-volt (dual metal-can type)</p> <p>C₃₇, C₃₈—Capacitors in i-f trans.</p> | <p>C₃₉, C₄₀—Dual 0.1-μfd. 400 volts</p> <p>C₄₁, C₄₂—Capacitors in i-f trans.</p> <p>C₄₃—Twisted-wire capacitor</p> <p>C₄₄—100-μfd. midget mica</p> <p>C₄₅—0.05-μfd. 400-volt tubular</p> <p>C₄₆—0.01-μfd. 400-volt tubular</p> <p>C₄₇—25-μfd. 25-volt elect.</p> <p>C₄₈—0.1-μfd. 400-volt tubular</p> <p>C₄₉—0.01-μfd. 400-volt tubular</p> <p>C₅₀—25-μfd. 25-volt elect.</p> <p>C₅₁—0.05-μfd. 400-volt tubular</p> <p>C₅₂, C₅₃, C₅₄, C₅₅—0.002-μfd. mica</p> <p>C₅₆—20-μfd. 450-volt elect.</p> <p>C₅₇—8-μfd. 450-volt elect.</p> <p>C₅₈, C₅₉—Dual 0.1-μfd. 400-volt</p> <p>C₆₀—250-μfd. midget mica</p> <p>R₁—200 ohms $\frac{1}{2}$ watt</p> <p>R₂—5000-ohm potentiometer</p> <p>R₃—47,000 ohms $\frac{1}{2}$ watt</p> <p>R₄—200 ohms $\frac{1}{2}$ watt</p> <p>R₅—470 ohms $\frac{1}{2}$ watt</p> <p>R₆—68,000 ohms $\frac{1}{2}$ watt</p> <p>R₇—1000 ohms $\frac{1}{2}$ watt</p> <p>R₈—22,000 ohms 2 watts</p> | <p>R₉—180 ohms $\frac{1}{2}$ watt</p> <p>R₁₀—270,000 ohms $\frac{1}{2}$ watt</p> <p>R₁₁—100,000 ohms $\frac{1}{2}$ watt</p> <p>R₁₂—200 ohms $\frac{1}{2}$ watt</p> <p>R₁₃—10,000 ohms $\frac{1}{2}$ watt</p> <p>R₁₄—3000 ohms 10 watts</p> <p>R₁₅—47,000 ohms $\frac{1}{2}$ watt</p> <p>R₁₆, R₁₇, R₁₈—100,000 ohms $\frac{1}{2}$ watt</p> <p>R₁₉—470 ohms $\frac{1}{2}$ watt</p> <p>R₂₀—68,000 ohms $\frac{1}{2}$ watt</p> <p>R₂₁—200 ohms $\frac{1}{2}$ watt</p> <p>R₂₂—470 ohms $\frac{1}{2}$ watt</p> <p>R₂₃—68,000 ohms $\frac{1}{2}$ watt</p> <p>R₂₄—200 ohms $\frac{1}{2}$ watt</p> <p>R₂₅—1.0 megohm $\frac{1}{2}$ watt</p> <p>R₂₆—100,000 ohms $\frac{1}{2}$ watt</p> <p>R₂₇—1.0 megohms $\frac{1}{2}$ watt</p> <p>R₂₈, R₂₉—470,000 ohms $\frac{1}{2}$ watt</p> <p>R₃₀—500,000-ohm potentiometer</p> <p>R₃₁—1000 ohms $\frac{1}{2}$ watt</p> <p>R₃₂—470,000 ohms $\frac{1}{2}$ watt</p> <p>R₃₃—220,000 ohms $\frac{1}{2}$ watt</p> <p>R₃₄—270,000 ohms $\frac{1}{2}$ watt</p> <p>R₃₅—270 ohms 2 watts</p> <p>R₃₆—22 ohms 2 watts</p> | <p>R₃₇—50,000 ohms 20 watts</p> <p>R₃₈—470,000 ohms $\frac{1}{2}$ watt</p> <p>R₃₉—47,000 ohms $\frac{1}{2}$ watt</p> <p>L₁, L₂, L₃, L₄, L₅, L₆—See coil table</p> <p>L₇, L₈—18 turns no. 24 enam. closewound on $\frac{1}{2}$" XR-30 coil form with 3-turn coupling links</p> <p>L₉—470-kc. crystal-filter transformer</p> <p>L₁₀, L₁₁—470-kc. i-f transformers</p> <p>L₁₂—470-kc. b-f-o transformer</p> <p>T₁—700 v. c.f. 90 ma., 5 v. 3 a., 6.3 v. 3.5 a.</p> <p>T₂—Push-pull plates to voice coil</p> <p>CH₁, CH₂—10.5-hy. 110-ma. chokes</p> <p>S₁—Crystal-filter switch in transformer</p> <p>S₂—5-p.s.t. b-f-o switch</p> <p>S₃—A-c line switch</p> <p>S₄—Plate-voltage switch</p> <p>F—3-ampere fuse</p> <p>X₁—5000-kc. crystal</p> <p>X₂—470-kc. crystal in i-f trans.</p> |
|---|---|---|--|

The 5.47-Mc. difference-frequency output of the 6AG5 first detector is link coupled from a tank in its plate circuit to another tuned circuit in the grid of the 6K8 second mixer. Since a low-impedance link is used between these two circuits the spacing between the two circuits is not critical and may be any reasonable distance.

The 6K8 second mixer stage uses an inexpensive 5-Mc. surplus crystal, for greatest stability, to convert the 5.47-Mc. incoming signal to the second i-f amplifier frequency of 0.47 Mc. or 470 kc. The plate of the 6K8 is coupled to a 470-kc. crystal-filter transformer and then through two 6K7 i-f amplifier stages to a 6H6 which acts as a combined third-detector

and noise limiter. The noise-limiter circuit is conventional, and is described in Chapter 5, using the circuit shown in Figure 30 of that chapter. The 6J5 beat-frequency oscillator for c-w use is coupled into the 6H6 third detector.

Since the receiver was designed primarily for c-w use no provision for a.v.c. has been included. But if it should be desired to use a.v.c. on the r-f and i-f stages of the receiver the a-v.c. voltage may be obtained from the load resistor of the detector portion of the 6H6 by means of a 2-megohm resistor and the conventional isolating and feed circuits to the grids of the r-f and i-f stages.

The audio system of the receiver is quite conventional, using

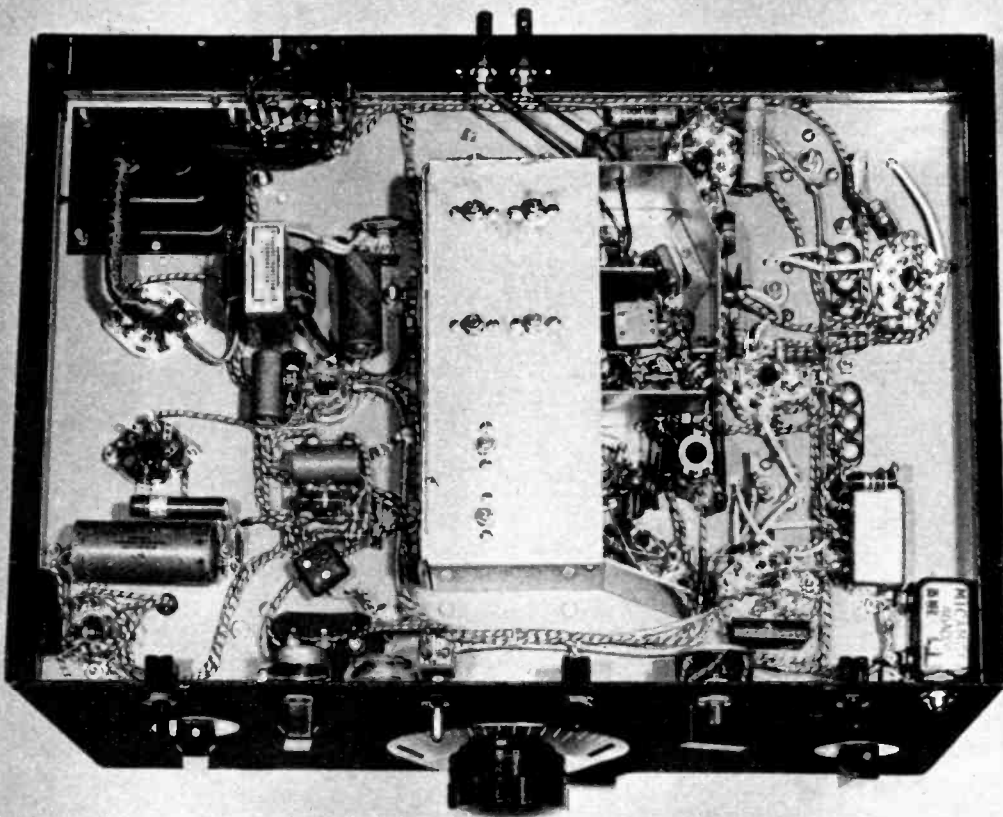

Figure 7.
UNDERCHASSIS VIEW OF THE
DOUBLE SUPERHET.

a 6SJ7 and a 6V6-GT with feedback from the plate of the 6V6-GT to the plate of the 6SJ7 to reduce harmonic distortion and improve the frequency response of the audio system.

Alignment The receiver is most satisfactorily aligned by starting at the 6H6 third detector with a signal on 470 kc. and working backward toward the crystal-filter transformer. After all circuits back to the crystal-filter transformer have been aligned the crystal may be switched into the circuit and the signal generator tuned back and forth across the nominal frequency of the filter crystal until the resonance peak is found. When this peak has been found, the signal generator should be left on this frequency, the crystal filter switched out of the circuit and the i-f transformers re-peaked slightly to insure that the aligned frequency of the channel is exactly on the crystal frequency.

After the 470-kc. channel has been aligned the signal generator is switched to 5.47 Mc. and the 5-Mc. crystal turned on. With the lead from the signal generator on the plate connec-

tion of the 6AG5 first mixer the two 5.47-Mc. tank circuits are aligned. After this has been done the h-f oscillator and r-f stages are aligned in the conventional manner, and tracked by the procedure discussed at the beginning.

The performance of the receiver is excellent, giving good signal-to-noise ratio on both bands and a complete absence of image responses on both the 14-Mc. and 28-Mc. bands. The dial for the receiver is a National NPW-O and the receiver is housed in an NC-100 blank cabinet.

BROAD-BAND "SIGNAL LIFTER" FOR 28-MC. AND 50-MC. BANDS

On occasion, after a receiver for one of the higher-frequency bands has been purchased or constructed, it is felt that the gain or the signal-to-noise ratio of the receiver leaves something to be desired. A conventional pre-selector may then be

Figure 8.
TOP VIEW OF THE TWO-CHANNEL BROAD-BAND
"SIGNAL LIFTER."

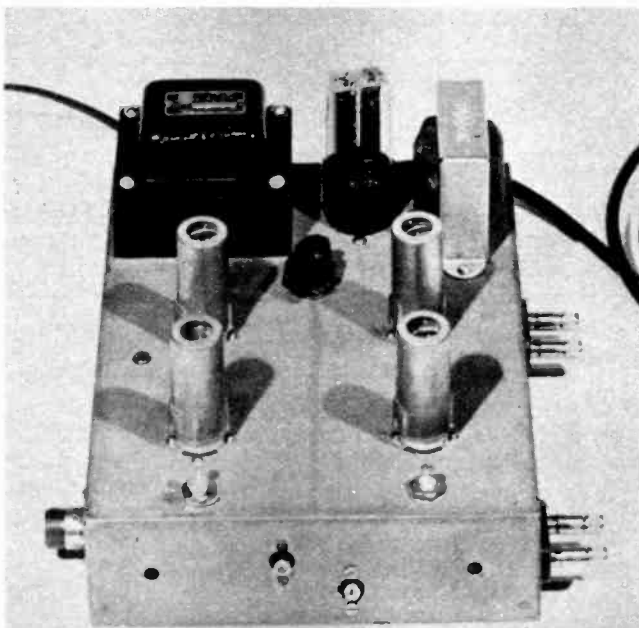
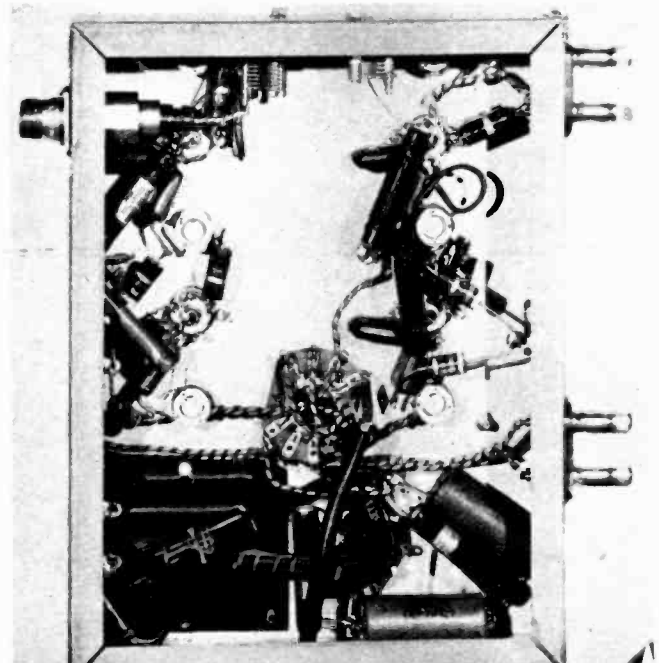

Figure 9.
UNDERCHASSIS VIEW OF THE SIGNAL AMPLIFIER
UNIT.

A coaxial fitting is used for the signal input to the 6-meter portion of the unit and a pair of open terminals are used for the input connections to the 10-meter channel.



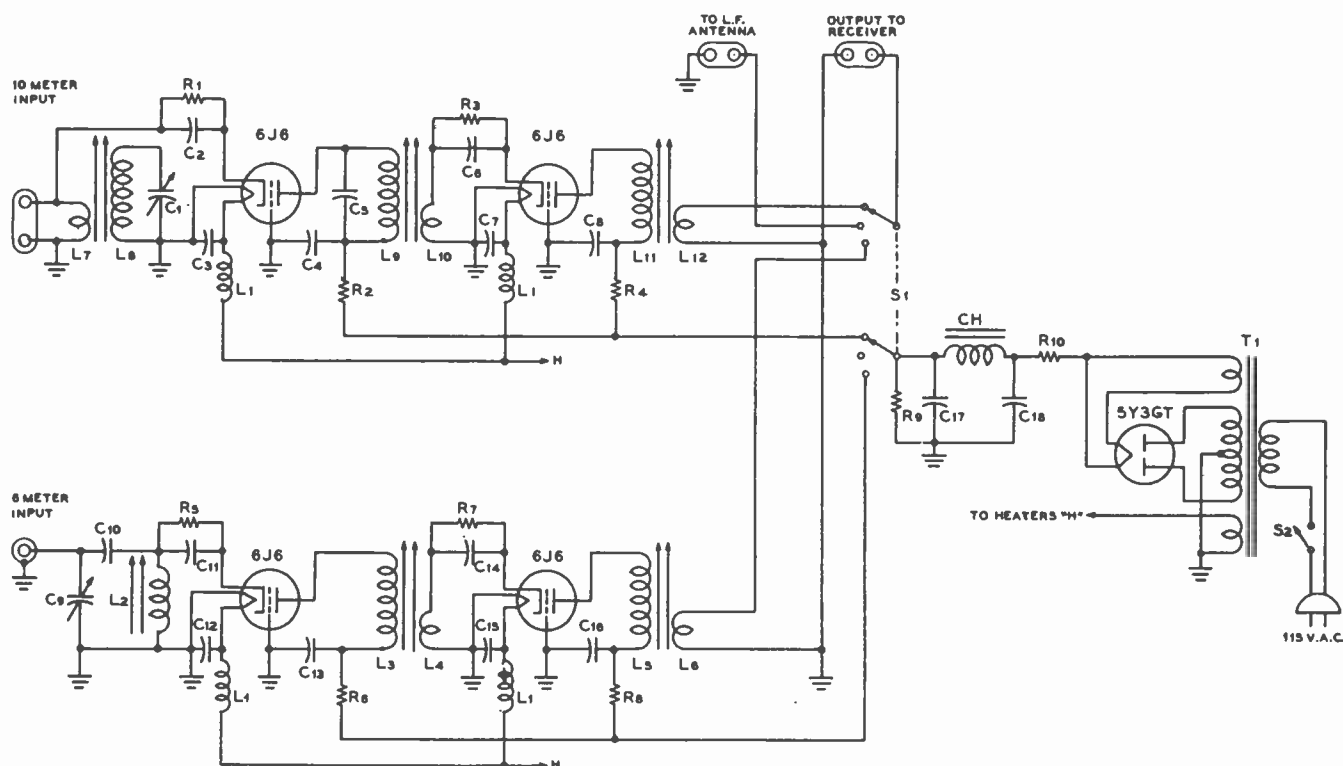

Figure 10.

SCHEMATIC DIAGRAM OF THE DUAL-CHANNEL SIGNAL AMPLIFIER.

- | | | | |
|--|--|---|--|
| C ₁ —25-μfd. air padder | C ₁₄ —500-μfd. midget mica | S ₁ —Channel switch, 2-pole 3-position wafar type | L ₅ —14 turns no. 30 enam. on 3/8" slug-tuned form |
| C ₂ —500-μfd. midget mica | C ₁₅ , C ₁₇ —0.003-μfd. mica | S ₂ —S.p.s.t. a-c line switch | L ₇ —2-turn link of hookup wire below L ₅ |
| C ₃ , C ₄ —0.003-μfd. mica | C ₁₇ , C ₁₈ —8-μfd. 450-volt elect. | L ₁ —5.5 microhenry 1000-ma. u-h-f r-f choke | L ₇ —3-turn link of hookup wire on L ₅ |
| C ₅ —5-μfd. (3" 75-ohm twin line) | R ₁ , R ₂ , R ₅ , R ₇ —100 ohms 2 watts | L ₂ —6 turns no. 22 enam. on 3/8" slug-tuned form | L ₇ —28 turns no. 30 enam. on 3/8" dia. slug-tuned form |
| C ₆ —500-μfd. midget mica | R ₂ , R ₄ , R ₆ , R ₈ —4700 ohms 2 watts | L ₃ —14 turns no. 30 enam. on 3/8" slug-tuned form | L ₈ —Same as L ₅ |
| C ₇ , C ₈ —0.003-μfd. mica | R ₉ —25,000 ohms 10 watts | L ₄ —4 turns no. 30 enam. on 3/8" slug-tuned form | L ₁₀ —Same as L ₇ |
| C ₉ —50-μfd. air padder | R ₁₀ —5000 ohms 10 watts | T ₁ —600 v. c.t. 55 ma., 5 v. 2 a., 6.3 v. 2.7 a. | L ₁₁ —Same as L ₅ |
| C ₁₀ —25-μfd. midget mica | CH—13 hy. at 65 ma. choke | | L ₁₂ —Same as L ₇ |
| C ₁₁ —500-μfd. midget mica | | | |
| C ₁₂ , C ₁₃ —0.003-μfd. mica | | | |

constructed or purchased to improve the performance of the receiver. But the addition of a pre-selector to the receiver means that an additional unit of equipment must be placed on the operating desk within easy reach since the tuning control on the pre-selector must be tuned along with the tuning of the receiver. Thus operating convenience is sacrificed for the improvement in performance.

If it were possible to connect a broad-band signal amplifier between the antenna circuit and the input of the receiver, such a unit could be placed out of the way, since it would not need tuning, and yet the improvement in signal-to-noise ratio and overall gain could still be obtained. It is for this application that the unit shown in Figures 8 and 9 was developed.

Circuit of the Broad-Band "Signal Lifter"

Figure 10 shows the circuit of the dual broad-band signal lifter for the 28-Mc. and 50-Mc. bands. Two channels are provided, one for each band, and each channel uses a pair of 6J6's in a cascaded grounded-grid triode amplifier. However, the two channels operate independently so that either one may be constructed. Only one triode section of each of the 6J6's is used in each stage, the other section being allowed to float. In a grounded-grid circuit such as is used it is possible to use the tube in only one circuit, and no appreciable improvement in performance will be obtained if both halves of the tube are used in parallel since the interelectrode capacitances are doubled at the same time that the transconductance is doubled.

Through the use of triodes in the r-f amplifier unit it is possible to obtain a substantial amount of gain with a relatively small increase in the noise level. In an actual test of this unit ahead of a good post-war communications receiver, the addition of the signal booster added less than one "S" division to the reading of the receiver but the strength of incoming signals was increased by three "S" divisions. This test was made on the 28-Mc. band and represents an improvement of 8 to 10 db in the noise factor of the receiver. Almost all the improvement may be attributed to the fact that triodes are used in the signal-amplifier. The balance of the improvement may be attributed to the fact that an increased signal level was being applied to the grid of the mixer stage in the receiver, thus further overriding the inherent noise of the mixer stage.

When the signal amplifier was used ahead of a 50-Mc. receiver using a conventional pentode tube in the r-f stage the improvement in the signal-to-noise ratio was even more striking. The addition of the external amplifier added only a just appreciable amount of noise to the output of the receiver but the strength of incoming signals was increased by more than three "S" divisions, or more than 15 db.

Triode versus Pentode R-F Amplifier Stages

The higher the frequency on which a test is made, the more striking will be the improvement in the performance of a triode r-f amplifier stage in a receiver over that of a pentode. This improvement may be attributed to a number of factors, all of which have been grouped together into

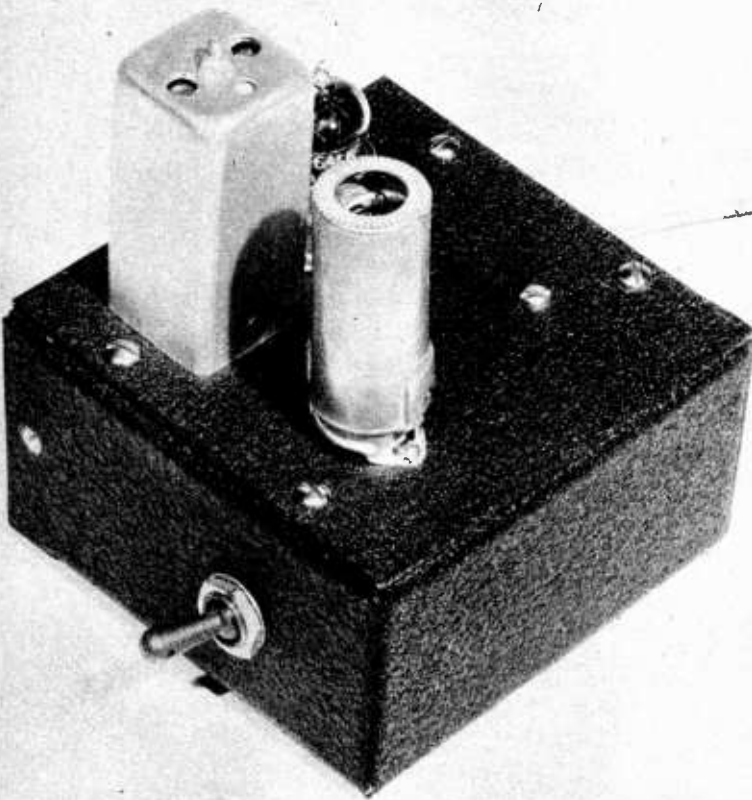

Figure 11.
TOP VIEW OF THE NBFM ADAPTER.

a quantity called the "equivalent noise resistance" of the tube. The tube having the lowest equivalent noise resistance for this type of application as a broad-band r-f amplifier is the 6J4 triode, which is also designed for use as a grounded-grid r-f amplifier. Close upon the 6J4 is the 6J6 which has been used in this unit of equipment. 6J4 tubes may be used in the unit to obtain even more striking performance, but the cost of the 6J4 tube is considerably greater than that of the 6J6.

Image Ratio Although the signal amplifier described gives an increase of approximately 15 db in the signal level fed to the receiver input, the very fact that it is a broad-band device means that the unit will contribute nothing to the image ratio of the receiver. Since the unit amplifies the level of all signals in the band, those signals which produce image responses are amplified the same amount as the desired signal. This is a fundamental disadvantage of the broad-band type of signal amplifier. (The broad-band type of converter, however, does not have this disadvantage since a very much higher value of effective intermediate frequency is used following the broad-band type of converter.) Hence, if the receiver into which the signal amplifier is operating already has a good image ratio, the amplifier will be quite satisfactory. But if the receiver has a poor image ratio, it will still have the same image ratio after the amplifier is installed, but the images will appear considerably stronger since they will be amplified sufficiently so that they will override the noise level within the receiver under conditions where they would have been lost in the receiver noise before the signal amplifier was installed.

Input Circuits for the "Signal Lifter"

Two different input circuits have been used in the signal lifter for coupling the antenna to the cathode of the first r-f amplifier stage. The circuit shown for 10-meter input is best for feeding of greater than 200 ohms to the first cathode and the circuit shown for 6-meter input is best for matching to an impedance of less than the approximate cathode impedance of the 6J6 of 200 ohms. Actually the input circuits chosen were for feeding from a 300-ohm line for the 10-meter input and for feeding from a 52-ohm coaxial line for the 6-meter input.

Provision has been made for three antenna inputs to the amplifier and for a single lead from the amplifier to the input circuit to which it is coupled. The 6-meter antenna is connected directly to the amplifier for this band and the 10-meter antenna is connected to the 10-meter input. The low-frequency antenna is connected to another set of terminals on the amplifier and when switch S₁ is in the center position the low-frequency amplifier is fed directly into the receiver. Both signal amplifiers are inoperative when the switch is in the center position.

NARROW BAND FM 465 KC. ADAPTER

The unit diagrammed in Figure 12 and shown in Figures 11 and 13 has been developed to fill a need for an adapter to convert a conventional communications receiver to give satisfactory reception of narrow-band FM signals. The unit is relatively simple to build, can be installed inside the receiver housing and is quite easy to adjust. Although NBFM can be received on a conventional communications receiver by tuning the receiver to one side or the other of the incoming signal, a tremendous improvement in signal to noise ratio and in signal-to-amplitude modulated interference will be obtained by using a true FM detection system for the reception of FM waves.

Circuit The circuit of the adapter is relatively simple, using two newly developed miniature tubes. A type 6AU6 tube is used as a limiter and a type 6AL5 as a discriminator. A conventional 465-kc. push-pull diode detector transformer has been used as a discriminator transformer. This type of transformer operates quite satisfactorily even though it is not designed for use in a discriminator circuit. Somewhat greater signal output voltage for a given amount of deviation can be obtained if a discriminator transformer designed for 465-kc. use is available. The limiter circuit itself is conventional using

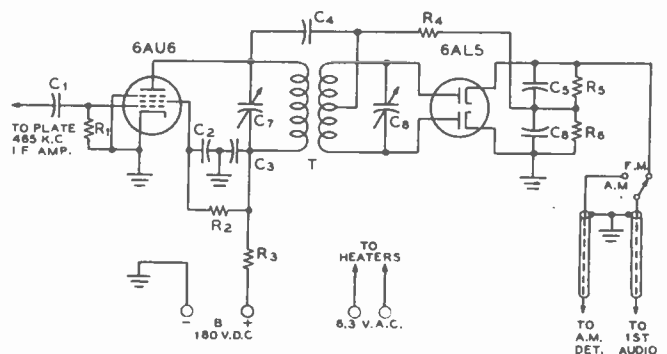

Figure 12.
SCHEMATIC DIAGRAM OF THE NBFM ADAPTER.
C₁—50-μfd. midget mica
C₂, C₃—Dual 0.1-μfd. bathtub
C₄—50-μfd. midget mica
C₅, C₆—100-μfd. midget mica
C₇, C₈—Trimmers on i-f trans.
R₁, R₂—220,000 ohms ½ watt
R₃—39,000 ohms 2 watts
R₄, R₅, R₆—100,000 ohms ½ watt
T—465-kc. discriminator trans. if available, if not a 465-kc. push-pull diode input trans. may be used.

grid-leak bias and reduced screen voltage on the 6AU6 tube. The discriminator circuit is also quite conventional and utilizes a resistor R_1 in place of a more bulky and more expensive r-f choke in the return lead for the discriminator transformer. The particular transformer used in the equipment shown is manufactured by the J. W. Miller Co. of Los Angeles and the type number is O12-C3.

The audio output level from the discriminator is approximately 10 volts peak for the maximum deviation which can be handled by a conventional 465 kc. i-f communications receiver. This amount of voltage is sufficient to drive directly a pentode or tetrode audio amplifier stage to adequate output; or if desired, the audio output of the unit may be run through the complete audio system of the receiver in place of the output of the AM detector. The simple circuit for accomplishing this result is shown in the circuit diagram for the equipment, Figure 12.

Operating Conditions The adapter unit requires approximately 3 ma. at 180 volts and 0.6 ampere at 6.3 volts for heaters. In most cases the small additional drain may be placed upon the regular power supply incorporated in the receiver.

The r-f grid voltage on the 6AU6 tube may be any value above about 0.5 volt for proper limiting action. This amount of voltage can usually be obtained by winding about 10 turns of hookup wire between the i-f coils in the last i-f transformer of the receiver. One side of the added coil should be grounded and the other side should be fed through a shielded lead or a coaxial cable to capacitor C_1 in the adapter unit. If it is not desired to go inside the i-f transformer a $10\text{-}\mu\text{fd.}$ capacitor may be connected to the plate of the last i-f or the next to last i-f stage and this lead then run through the shielded cable to the adapter unit. This latter procedure, however, will require re-aligning of the plate section of the i-f transformer, and unless considerable care is taken may result in a tendency toward i-f instability in the receiver.

Tuning Procedure After the adapter unit has been installed and connected into the receiver i-f channel, an unmodulated signal should be fed into the receiver. The receiver is then tuned by means of its tuning meter or other indication so that the incoming signal is peaked exactly in the center of the i-f channel. Then a high resistance d-c voltmeter (50,000 ohms per volt if possible) is placed across R_a . The primary of the discriminator transformer T is then tuned for maximum indication on the voltmeter. Following this the secondary of the discriminator transformer is peaked for maximum indication. The ungrounded voltmeter lead is then removed and connected across the audio output terminal of the discriminator.

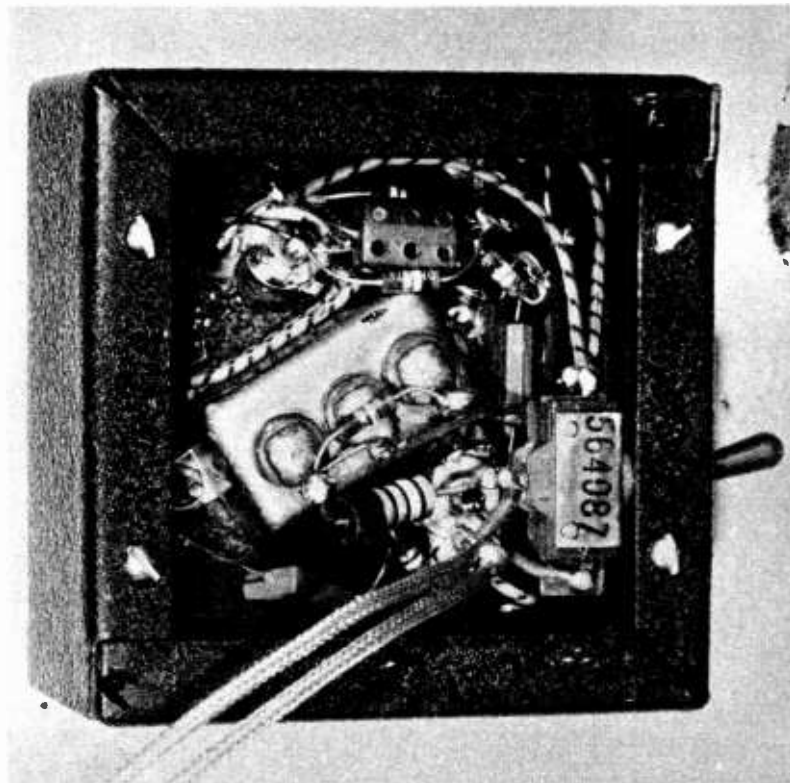

Figure 13.
UNDERCHASSIS OF THE 465-KC. FM ADAPTER.

The communications receiver is now swung back and forth across the frequency of the incoming signal and the movement of the voltmeter noted. When the receiver is exactly tuned on the signal the voltmeter reading should be zero. When the receiver is tuned to one side of center, the voltmeter should increase to a maximum value and then decrease gradually to zero as the signal is tuned out of the pass band of the receiver. When the receiver is tuned to the other side the voltmeter reading should increase to the same maximum value but in the other direction (requiring that the meter leads be reversed) and then fall to zero. It will undoubtedly be necessary to make small adjustments in the trimmer on the secondary of the discriminator transformer to make the voltmeter read zero when the signal is tuned in the center and rise to the same value if the receiver is tuned the same distance either side of center.

Converters for the 28-Mc. and 50-Mc. Bands

THE upper frequency limit for most of the war surplus receivers is about 18 Mc., and the upper frequency limit for the great majority of amateur communications receivers is usually some frequency just above 30 Mc. Consequently, many amateurs desiring to operate on the 28-Mc. and 50-Mc. bands are forced to use some sort of converter ahead of their regular communications receiver. Also, an increasing percentage of amateurs operating on the 28-Mc. band are using converters ahead of their communications receiver even though coverage of the 28-Mc. band is afforded by the receiver. Through the

use of a good "hot" converter operating into an intermediate frequency in the range from 1.5 to perhaps 12 Mc. it is possible in many cases to obtain a worthwhile improvement in signal-to-noise ratio, an increase in overall gain, and a great reduction in image responses.

Types of Converters Although the basic principle of operation of all converters is the same, there are several possible procedures whereby signals on different frequencies may be selected so that they will fall in the pass band of the receiver. The two most practicable methods are: (A) Utilizing a fixed second beating oscillator and a fixed intermediate frequency of 1.5 to 12 Mc., tuning in of the desired signal being accomplished by varying the frequency of the first beating oscillator and then tracking the r-f circuits with this oscillator. (B) Utilizing a fixed first beating oscillator with broad-band circuits in the antenna and mixer circuits, selection of the desired signal being accomplished by varying the frequency of the second beating oscillator and the first intermediate frequency.

Each system of frequency conversion offers advantages and disadvantages. The system (A) has long been used and is more or less the standard procedure for constructing a converter. The system is effective and is easy to align since sharply resonant circuits are used in all stages. It does, however, have the strong disadvantage that the high-frequency beating oscillator must be stable and yet must be tunable over a considerable frequency range, and in addition the tuned circuits associated with the r-f and mixer tubes must be tracked with the oscillator. Another consideration, which may be an advantage or a disadvantage in different cases, is the fact that such a converter often may have a relatively large signal-voltage gain

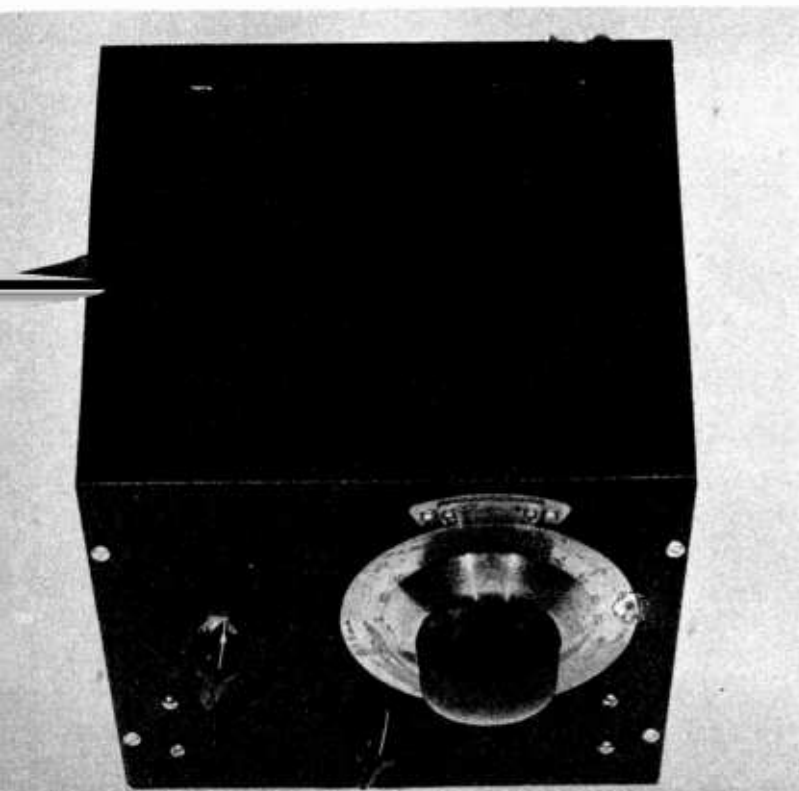

Figure 1.
LOOKING DOWN ON THE 28-MC. CONVERTER.

which sometimes will overload the a-v-c system of the receiver into which the converter is operated.

The (B) system is much more recent, and has become practicable with the introduction of tubes which are capable of delivering considerable gain over a band of frequencies measured in terms of megacycles. The 6J4, 6J6, and 6AK5 are three relatively recent tubes which are excellently suited for use in broad-band amplifier circuits. The (B) system has the strong advantage that no tuning whatsoever is required in the converter after it has once been adjusted to obtain proper operation. Hence there are no difficult mechanical problems, there are no ganging troubles, and further, the calibration on the dial of the communication receiver may often be used as the calibration for frequencies coming into the converter simply by adding the frequency of the oscillator in the converter to the frequency reading of the communications receiver dial. This latter assumes, of course, that the beating oscillator in the converter is operating at a frequency below the frequency of the desired incoming signal, by the value of intermediate frequency chosen.

Converters of the broad-band (B) type have the disadvantage, however, that unusual precautions must be taken to minimize spurious responses. These responses are of two general types: those which arise as a result of signals being received directly on the tuned frequency of the receiver into which the converter operates. These signals may come straight through the converter due to its broad-band characteristics, or the signals may get into the receiver due to insufficient shielding. In either event a series-resonant trap circuit connected across the antenna leads of the converter will greatly attenuate these signals coming through on the frequency to which the receiver is tuned.

The second type of spurious response comes about as a result of harmonics of the local oscillator in the receiver which the converter feeds. Very little can be done about these responses, but since they normally come at only one or two places in the band their presence may usually be tolerated.

Converters of the (A) type may be used with any type of receiver, including a broadcast receiver, which may be tuned to the frequency chosen for the intermediate amplifier. One of

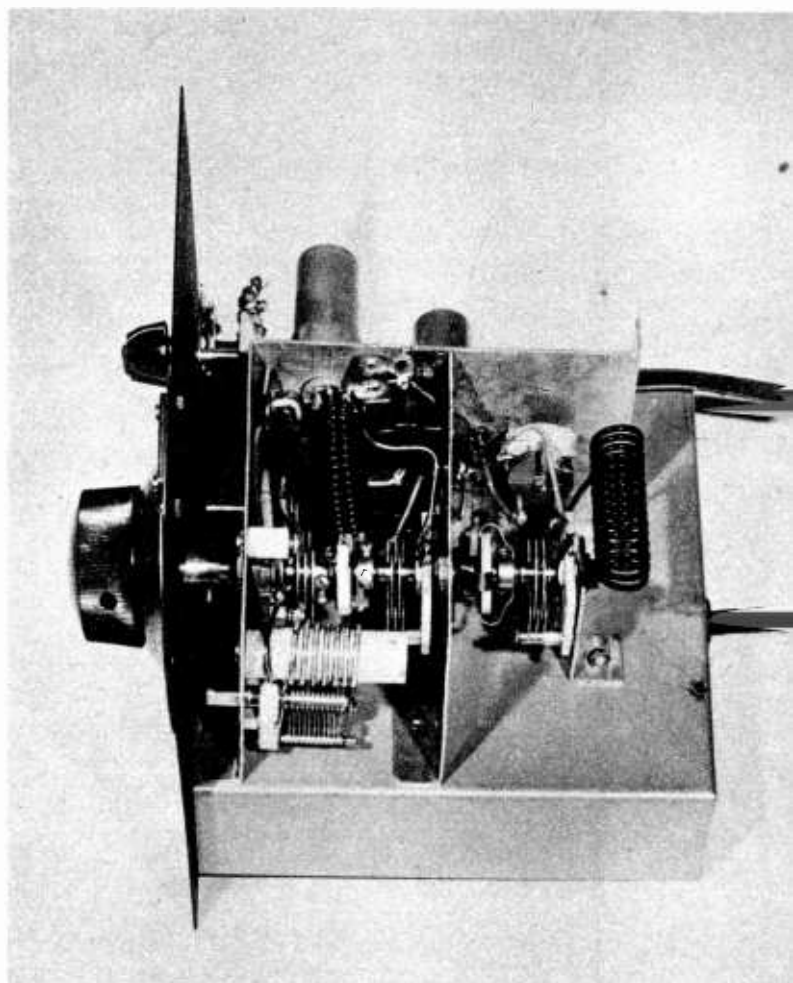

Figure 2.
SIDE VIEW OF THE CONVERTER REMOVED FROM THE CABINET.

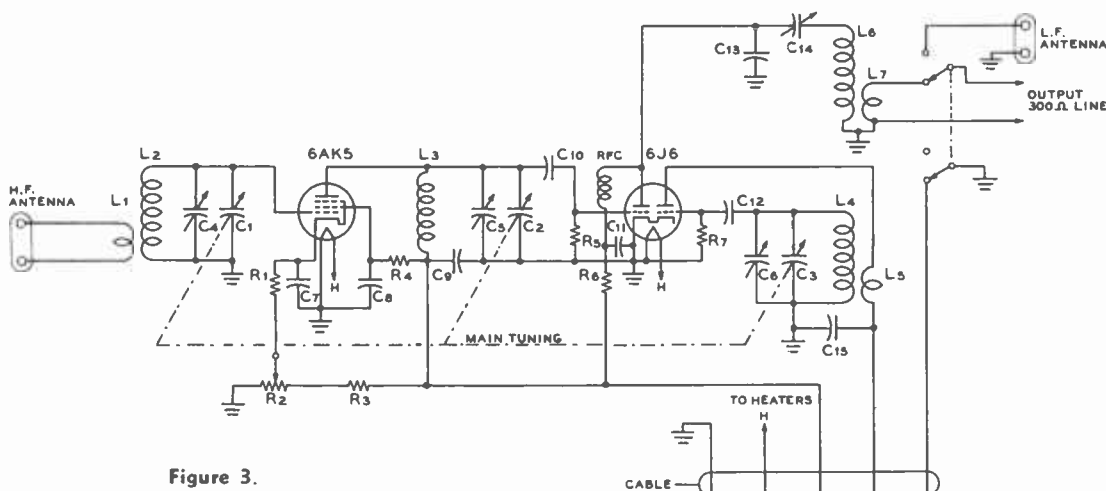

Figure 3.

SCHEMATIC DIAGRAM OF THE 28-MC. CONVERTER.

- | | |
|---|--|
| C ₁ , C ₂ —15- μ fd. midget variables | C ₁₁ —100- μ fd. air padder |
| C ₃ —35- μ fd. midget variable | C ₁₂ —0.005- μ fd. mica |
| C ₄ , C ₅ —25- μ fd. air padder | R ₁ —270 ohms 1/2 watt |
| C ₆ —100- μ fd. air padder | R ₂ —3000-ohm potentiometer |
| C ₇ , C ₈ , C ₉ —0.005- μ fd. mica | R ₃ —47,000 ohms 2 watts |
| C ₁₀ —15- μ fd. ceramicon | R ₄ —27,000 ohms 2 watts |
| C ₁₃ —0.005- μ fd. mica | R ₅ —100,000 ohms 1/2 watt |
| C ₁₄ —25- μ fd. ceramicon | R ₆ —100 ohms 1/2 watt |
| C ₁₅ —300- μ fd. ceramic | R ₇ —39,000 ohms 1/2 watt |
| | RFC—2.5-mh. 125-ma. r-f choke |

- | | |
|--|--|
| L ₁ —6 turns no. 14 1/2" dia. | L ₂ —2 turns no. 18 enam. wound 5/16" from cold end of L ₁ |
| L ₂ —15 turns no. 12, 1/2" dia. spaced to 2 inches | L ₃ —1 1/8 inches no. 30 enam. closewound on 1" diameter form |
| L ₃ —Same as L ₂ | L ₄ —7 turns no. 14 bare cemented on 3/8" dia. ceramic form, spaced to 1" |
| L ₄ —7 turns no. 14 bare cemented on 3/8" dia. ceramic form, spaced to 1" | L ₅ —7 turns hookup wire on cold end of L ₄ |

the aircraft receivers of the ARC-5 or SCR-274N series makes a good i-f amplifier for a converter of this type. For a converter of the (B) type a good communications receiver with accurate dial calibrations is best.

6AK5-6J6 CONVERTER FOR THE 28-MC. BAND

Figures 1 and 2 illustrate a very effective converter for the 28-Mc. band using a 6AK5 r-f stage and a 6J6 as a combined oscillator and mixer. Since the coils for this receiver are soldered in place for single-band operation it is possible to obtain optimum L to C ratio and good Q for high gain and excellent image rejection in the converter. Three midget variable capacitors are ganged for tuning the converter. C_1 and C_2 are each 15- μ fd. midgets and C_3 , which tunes the high-frequency oscillator, is a 35- μ fd. variable of a slightly larger type than C_1 and C_2 . Padder capacitors have been placed across all the r-f and oscillator coils so that accurate alignment is possible. With the values of capacitance as shown and the coil dimensions given the converter tracks accurately over the range from 27 to 30 Mc.

A cathode-bias control is used on the 6AK5 r-f stage. Due to the extremely high gain in this stage if the gain control is turned full open there is some regeneration in the stage. In fact, with the antenna disconnected, the stage will oscillate due to the residual grid-to-plate capacitance within the 6AK5 tube. The socket for the 6AK5 tube is mounted so that the shield between the r-f stage and the detector-oscillator compartment bisects the socket. A soldering lug is run from the center shield of the miniature socket to a bolt on the inter-stage shield.

The 6J6 combined oscillator-mixer stage is operated with the cathode grounded and with grid-leak bias on both the oscillator portion and the mixer portion. No external provision for local-oscillator injection into the mixer portion of the 6J6 has been included since ample coupling exists within the tube itself. The circuit shown was chosen after several other circuits were tried, this particular circuit giving the best performance with best oscillator stability.

The mixer plate of the 6J6 is coupled to the 1.8-Mc. output circuit in a rather unconventional manner. Due to the relatively low plate resistance of the 6J6, if the plate current of the tube is fed through L_a in the conventional manner the tuning of the output circuit will be extremely broad as a result of loading on the tank circuit by the 6J6 plate resistance. However, through the use of the impedance matching network (or tapped-tank circuit, whichever you may wish to call it) between the plate of the 6J6 and the output tank it is possible to obtain considerably greater voltage gain out of the mixer stage and in addition the output tank circuit tunes quite sharply. With the value of components shown for the output tank circuit an i-f of from 1.5 Mc. to 1.9 Mc. may be used. Some experimentation with the value of the intermediate frequency to be used should be made. While the tracking will be good over the entire range given, it will be best at some frequency within the range specified above.

An output control switch has been provided so that when the converter is switched out of the circuit the input circuit of the low-frequency receiver is removed from the converter output and connected to a low-frequency antenna.

The entire converter may be operated from a supply which delivers 6.3 volts at 0.625 amperes and 125 volts at 25 ma., with a resistor of 6800 ohms at 2 watts connected between the plus 125-volt terminal and the plus 90 volt terminal for the oscillator. Or, if desired, the voltage fed to the oscillator tube may be stabilized by means of a VR-90 and an 1800-ohm 2-watt resistor running from the 125-volt lead to the anode of the VR-90 tube.

TUNED CONVERTER FOR 28-MC. AND 50-MC. BANDS

The converter shown in Figures 4, 5, and 6 uses a 6AK5 r-f stage, a 6BE6 mixer, and a 6C4 oscillator, with a 5Y3-GT and a VR-105 in the self-contained power supply. By using an i-f output frequency of 11.75 Mc. it is possible to use only one local-oscillator range for both the 10-11 and the 6-meter bands, the 6C4 oscillator covering the frequency range from 38.2 to 42.3 Mc., with the 6-meter band 11.75 Mc. on the high side of the oscillator and the 10-11 meter band the same number of megacycles on the low side of the oscillator. The 6-meter band covers the entire dial of the converter, and the 10-11 meter band covers from a dial reading of approximately 20 to 80 with a gap, of course, between the 11-meter and the 10-meter bands. Provision has been made for the use of plug-in coils in all three stages even though the oscillator coil need not be changed when changing from the 6-meter band to the 10-meter band. This provision has been made in the event that it is desired to wind a set of coils for the 21-Mc. frequency range.

As mentioned before, the power supply for the converter is self-contained, and a VR-105 tube has been used to obtain stabilization of the plate voltage on the high-frequency oscillator. The screen voltage for the 6AK5 r-f stage is controlled by potentiometer R_a as the gain control on the converter. The stability of the converter, constructed as is shown in the photographs, is unusually good. Drift is very small and the total drift is complete within two or three minutes after the power has been applied. The note of the high-frequency oscillator is clean and stable, permitting a c-w signal on the 50-Mc. band to be copied with ease. Also, since the high-frequency oscillator coil is not changed for either 6 or 10 meter operation, the stability of the converter is the same on both the 6-meter and the 10-11 meter bands.

Coils Coils for the converter are wound as described in the data below Figure 7. Then the local oscillator padder capacitor C_a is trimmed until the oscillator tunes the range (as determined if possible by listening to another receiver) from 38.2 to 42.3 Mc. Some juggling of the point at which C_a taps onto the coil will undoubtedly be necessary to make the oscillator cover the exact frequency range given. Then padder capacitors C_1 and C_2 are tuned for maximum noise-level output from the converter, with the 10-11 meter coils in place in their



Figure 4.
TOP VIEW OF THE 6 AND 10 CONVERTER IN ITS CABINET.

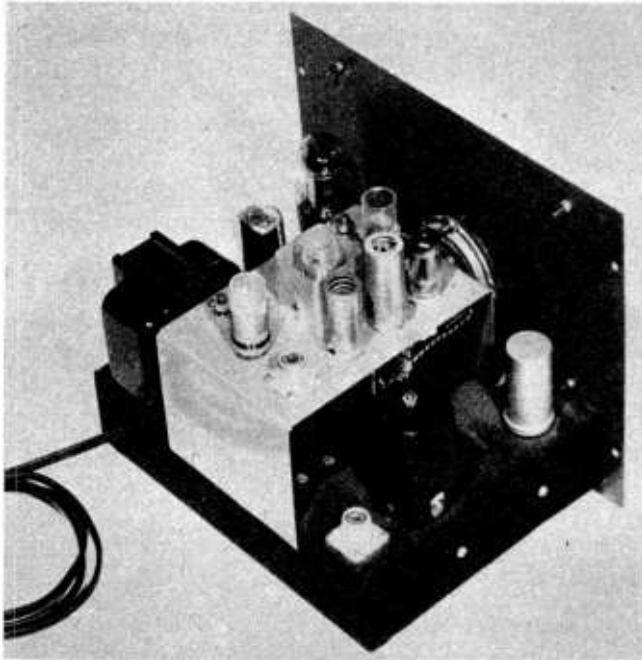

Figure 5.
SIDE VIEW OF THE CONVERTER CHASSIS.

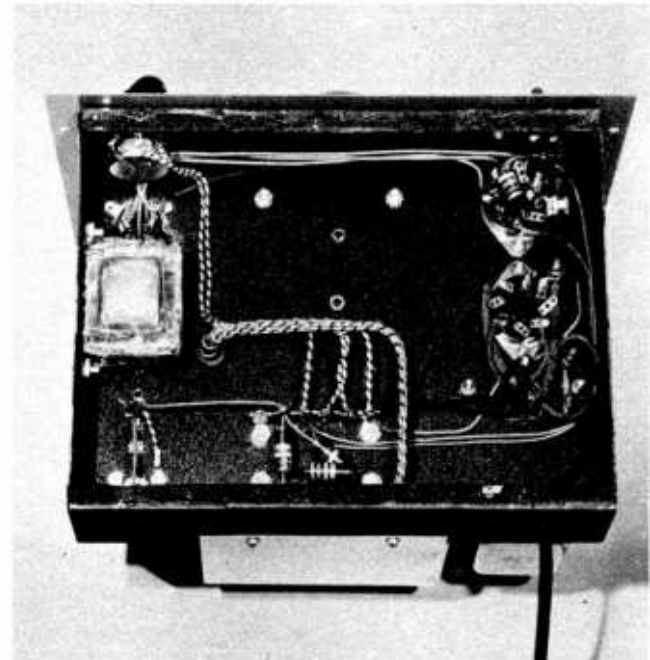

Figure 6.
UNDERCHASSIS VIEW OF THE 10-11 AND 6 METER CONVERTER.

respective sockets. Excellent tracking on this band was obtained with tuning capacitors C_1 and C_2 tapped across the entire coils. Note that a 220,000-ohm $\frac{1}{2}$ -watt resistor is placed inside the coil form across the grid circuit of the 6BE6 mixer on this band. This resistor was required since the input resistance of the 6BE6 when operating with separate excitation as a mixer is negative for the optimum operating conditions chosen. Hence it is necessary to parallel the input tank circuit for the tube with a resistor of such value to cancel the negative input resistance of the tube. The signal-to-noise ratio of the converter is improved by the addition of this resistor, and any tendency toward instability in the mixer stage is eliminated.

The coils for the 6-meter band are wound on slug-tuned forms which have been cemented into sawed-off forms of the same type as used for the 10-11 meter range. After the paddler capacitors for the 10-11 meter range have been set, the slugs in the 6-meter coils are adjusted for peaking on the 6-meter range. It may be necessary to vary the tapping point for the tuning capacitors C_1 and C_2 for accurate tracking over the entire band. Due to the high gain of the 6AK5 r-f stage and due to the relatively high feedback capacitance of this tube, the gain cannot be advanced fully on the 50-Mc. band.

Construction The converter is assembled on a 9 by 7 by 2 inch chassis, with a separate chassis made from a bent piece of aluminum mounted on top of the main chassis for the r-f section of the unit. The additional chassis is constructed from 0.032" aluminum and its dimensions are $4\frac{1}{4}$ by $2\frac{1}{2}$ inches above the chassis by $5\frac{1}{2}$ inches deep. Lips are extended downward in the rear and bent outward in front for mounting the chassis. All supply voltages to the chassis are brought through a single cable so that the chassis may be disconnected from the main chassis and bent back for working on it. An inter-stage shield is built into the chassis between the r-f and mixer-oscillator compartments. This shield is centered below the socket for the 6AK5 r-f amplifier tube. Coaxial connectors are used for input and output cables from the converter.

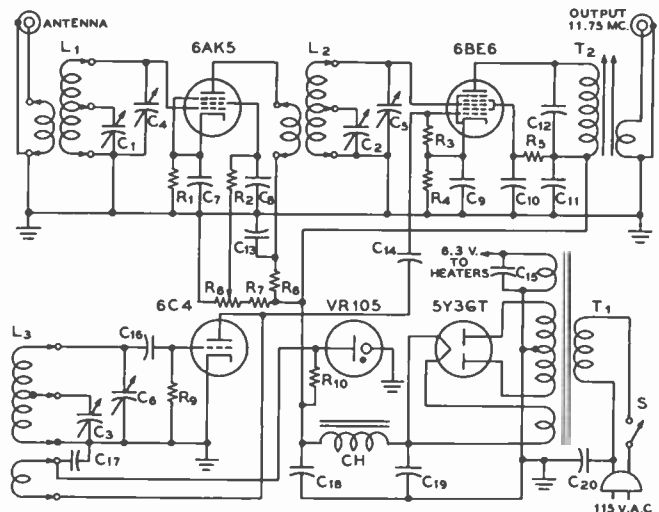

Figure 7.
SCHEMATIC DIAGRAM OF THE TWO-BAND CONVERTER.

- C_1, C_2 —Dual 10- μ fd. variable
- C_3 —50- μ fd. midget variable
- C_4, C_5 —25- μ fd. air padders
- C_6 —100- μ fd. air paddler
- $C_7, C_8, C_9, C_{10}, C_{11}$ —0.003- μ fd. mica
- C_{12} —25- μ fd. silver mica
- C_{13} —0.003- μ fd. mica
- C_{14} —10- μ fd. midget ceramic
- C_{15} —0.003- μ fd. mica
- C_{16} —50- μ fd. midget mica
- C_{17} —0.003- μ fd. midget mica
- C_{18}, C_{19} —Dual 10- μ fd. 450-volt electrolytic
- C_{20} —0.003- μ fd. midget mica
- R_1, R_2 —100 ohms $\frac{1}{2}$ watt
- R_3 —22,000 ohms $\frac{1}{2}$ watt
- R_4 —180 ohms $\frac{1}{2}$ watt
- R_5 —22,000 ohms 2 watts
- R_6 —50,000-ohm potentiometer
- R_7 —47,000 ohms 2 watts
- R_8 —100 ohms $\frac{1}{2}$ watt
- R_9 —100,000 ohms $\frac{1}{2}$ watt
- R_{10} —4700 ohms 2 watts
- L_1, L_2 —28 Mc.: $8\frac{1}{2}$ t. no. 18 tinned on $\frac{3}{4}$ " form spaced to $\frac{3}{8}$ ". Pri. 4 t. no. 20 enam. closewound, Detector coil has 220K res. 50 Mc.: 5 t. spaced to $\frac{5}{8}$ " on $\frac{1}{2}$ " dia. slug-tuned form. Pri. 4 t. no. 24 enam. closewound
- L_3 — $2\frac{1}{2}$ t. no. 12 plated copper on $\frac{3}{4}$ " dia. form spaced wire dia. Tickler 5 t. no. 20 enam. on cold end.
- T_1 —640 v. c.t. 40 ma., 6.3 v. 2 a., 5 v. 2 a. power trans.
- T_2 —8 turns no. 28 enam. closewound on $\frac{3}{8}$ " dia. permeability-tuned form. Link 8 t. same wire spaced $\frac{1}{8}$ " from ground end.
- S—A-c line switch, s.p.s.t.

SIMPLE BROAD-BAND CONVERTERS FOR 28-MC. AND 50-MC. BANDS

The broad-band converter using triode tubes is the most satisfactory device for the person desiring the utmost in simplicity along with top performance. The two simple converters shown in Figures 8 and 9 utilize a grounded-grid r-f amplifier and impedance matching stage coupled to the grid of a 6J6 combination oscillator-mixer. The grounded-grid r-f stage gives a very worthwhile amount of signal gain with a very low value of inherent noise level. The use of a triode r-f stage coupled with a triode mixer results in a unit having a remarkably good signal-to-noise ratio and still having ample signal gain. With either of the units shown coupled into the antenna circuit of a BC-348 receiver the gain of the overall receiver-converter combination is greater than that of the receiver alone, and the signal-to-noise ratio is unusually good.

The Circuit The circuit of the 28-Mc. converter is given in Figure 10. The converter for the 50-Mc. band has the same circuit except that a transformer is used as the interstage coupling impedance L_1 . The plate current of the 6J4 r-f stage passes through the primary winding and the grid coupling capacitor C_1 is connected to the hot end of the secondary winding with the other end of the secondary grounded. Data for construction of the interstage coupling impedance L_1 is given in the coil table for both bands.

It was deemed best to build two converters for the two bands rather than to try and use plug-in coils both from the standpoint of circuit efficiency and simplicity and as a result of the fact that separate antenna systems are almost invariably used for the 28-Mc. and 50-Mc. bands. The type 6J4 tube has an unusually high transconductance coupled with low interelectrode capacitances, making it ideally suited to use as a grounded-grid r-f amplifier stage in a broad-band system. The cathode input impedance of approximately 100-ohms means that a special coupling circuit must be used to couple into the cathode circuit of the tube. The L_1 - C_1 circuit shown in Figure 10 permits the matching of a relatively wide range of impedances to the cathode circuit of the tube and still has sufficiently great bandwidth so that approximately 3 megacycles may be covered with no apparent variation in stage gain.

The 6J6 mixer circuit is quite conventional, and is essentially the same as that in the 6AK5-6J6 converter described at the beginning of this chapter. The oscillator is tuned to a frequency of 20 Mc. for tuning of the 10-11 meter band from 7.16 Mc. to 9.7 Mc. on the dial of the receiver into which the converter is coupled. The frequency of the incoming signal is obtained simply by mentally placing a 2 in front of the dial reading of the receiver. For the 6-meter band the beating oscillator is on a frequency of 36 Mc. so that the 6-meter band covers from 14. to 18 Mc. on the receiver dial. In this case one adds 36 to the dial reading, although it is simpler mentally to subtract 4 and add 40 to the receiver calibrated frequency. In the case

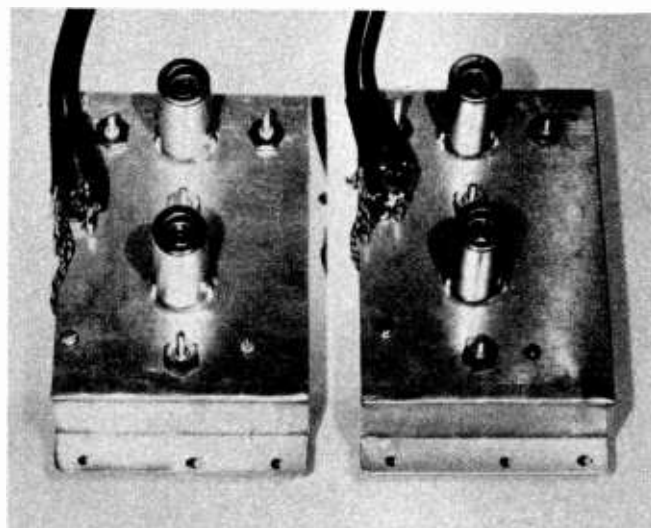

Figure 8.
TOP VIEW OF THE 28-MC. AND THE 50-MC. BROAD-BAND CONVERTERS.

of the 10-meter converter the output coupling circuit L_2 is tuned to 8.43 Mc., and for the 6-meter band the output coupling circuit is tuned to 16 Mc. although slightly improved gain will be obtained on the lower half of the band if the circuit is peaked on 15 Mc.

Construction The converter units are very simple to construct, and if the placement of components shown in the photographs is followed no difficulty with self-oscillation should be encountered. The chassis are bent from strips of aluminum $3\frac{3}{4}$ inches wide, and the top surface of the chassis is $5\frac{1}{4}$ inches long. Lips are bent down at each end so that the unit may be mounted with the same holes which originally held the dynamotor of the BC-348. Although the particular units shown were constructed to be mounted inside a BC-348 receiver, they operate equally well when coupled into any well-shielded receiver covering the frequency ranges mentioned above. It was found necessary to use a coaxial cable for the input and output circuits of the converter to eliminate reception of signals on the frequency to which the main receiver of the combination is tuned. With the converter mounted in the receiver as shown in Figure 11, however, reception of undesired signals was found to be satisfactorily low.

There is one undesirable condition which comes about as a result of operating a broad-band converter into a receiver in this manner. At several points on the dial the harmonics of the local oscillator in the main receiver will be picked up by the converter and passed back into the receiver. With the BC-348 operating on the 10-meter band in this manner there is one such response at about 28.550 Mc. On the 50-Mc. band a relatively strong response is obtained at about 51.2 Mc. and several less strong responses are obtained near the high-frequency end of the band with a BC-348 receiver.

Aligning the Converters The first step in aligning the converters is to adjust the tuning slug of the coil L_1 until the frequency of the beating oscillator is 20 Mc. for the 10-meter band or 36 Mc. for the 6-meter band. Then the receiver into which the converter is to operate is fed from

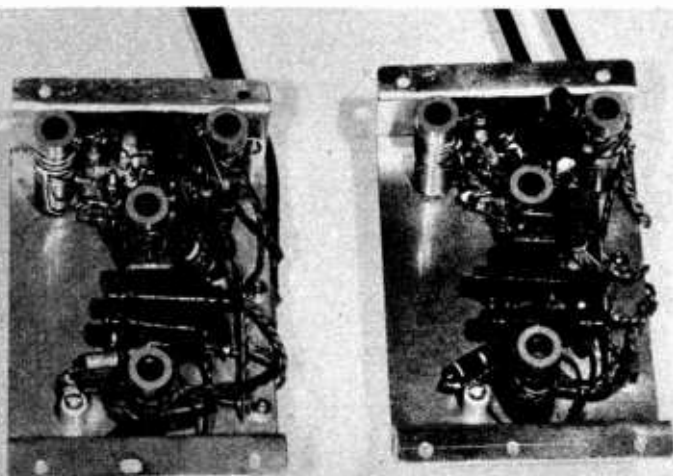

Figure 9.
UNDERCHASSIS VIEW OF THE TWO BROAD-BAND CONVERTERS.

COIL TABLE		
BROAD-BAND CONVERTERS FOR 28 AND 50 MC.		
Coil	28-Mc. Band	50-Mc. Band
L ₁	12 turns no. 24 enam. tapped 2 turns from ground end for cathode. 3-turn link of hookup wire at ground end for antenna	6 turns no. 24 enam. tapped 2 turns from ground end for cathode. 3-turn link of hookup wire at ground end for antenna
L ₂	16 turns no. 24 enam. closewound	Plate coil—3 t. no. 24 enam. closewound spaced 1/8" from grid coil Grid coil—4 turns no. 24 enam. closewound on end opposite mounting. A 15-μfd. ceramic capacitor is placed across the grid coil.
L ₃	7 turns no. 14 bare spaced to fill form. Tapped at 2 turns from plate end.	4 turns no. 14 bare spaced to fill form. Tapped at 1 1/2 turns from plate end.
L ₄	30 turns no. 28 enam. closewound with 5-turn link of hookup wire at ground end of coil	26 turns no. 24 enam. closewound with 5-turn link of hookup wire at ground end of coil

the output of the converter and the receiver is tuned to 8.43 Mc. for 10 or to 15 Mc. for 6. With the converter operating the slug in coil L₄ is varied until maximum noise level is apparent at the output of the main receiver. The tuning process will be facilitated if an output meter is fed from the output of the main receiver. After L₄ has been peaked, L₃ is peaked on noise and then L₁ is peaked on noise without the antenna connected. Then the antenna is coupled to the input of the converter and L₁, L₂, and L₃ are re-peaked for maximum noise output with no signal being received.

The main receiver is now tuned to cover the frequency range over which the amateur band should be received. There should be but a very small variation in the average background noise level over the whole of the 10-11 meter band and over the major portion of the 6-meter band.

The stability of the oscillators shown in the converters is such that c-w signals may be copied with ease on both the 28-Mc. band and on the 50-Mc. band. If the ultimate in stability is desired a crystal oscillator on 20 Mc. or on 36 Mc. using one of the new miniature high-frequency crystals may be used as the beating oscillator in the converter.

Input and Output Circuits The input and output tuned circuits for the converter have proven to be satisfactory for operation of the converter from a 300-ohm feed line into the input of a BC-348 receiver. However, for use

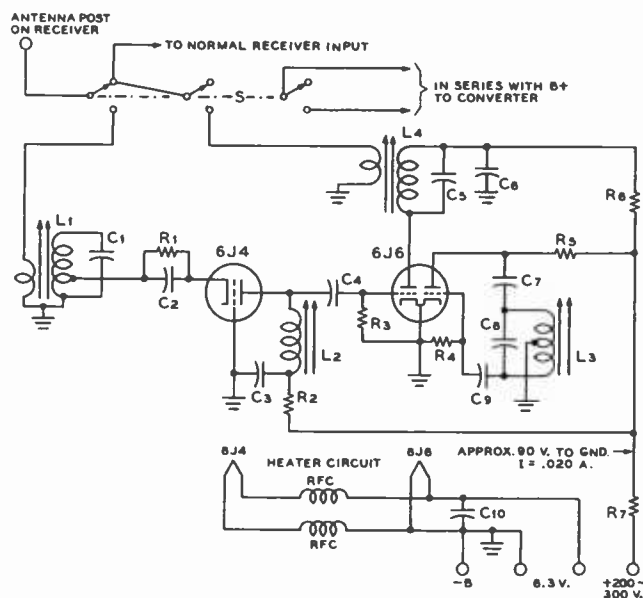

Figure 10. SCHEMATIC DIAGRAM OF THE BROAD-BAND CONVERTERS.

- C₁—5-μfd. miniature ceramic, or 3" 75-ohm twinlead
- C₂—500-μfd. midget mica
- C₃—0.002-μfd. midget mica
- C₄—50-μfd. midget mica
- C₅—15-μfd. midget mica
- C₆, C₇—0.002-μfd. mica
- C₈—100-μfd. zero-coefficient ceramic capacitor
- C₉—50-μfd. midget mica
- C₁₀—0.002-μfd. midget mica
- R₁—47 ohms 1/2 watt
- R₂—4700 ohms 2 watts
- R₃—100,000 ohms 1/2 watt
- R₄—47,000 ohms 1/2 watt
- R₅—4700 ohms 2 watts
- R₆—1000 ohms 2 watts
- R₇—5000 ohms 10 watts
- RFC—5.5-μhy. 1000-ma. chokes (midget v-h-f type)
- S—Converter on-off switch (not mounted in the chassis of unit)
- Coils—See coil table

with other types of feed line and other receivers it may be possible to obtain slightly improved bandwidth and perhaps a small increase in overall gain with other types of input and output circuits. Two alternative input circuits suitable for feeding the cathode of a broad-band grounded-grid amplifier are shown in the "signal lifter" described in Chapter 18. The circuit shown for the 6-meter portion of the signal lifter may be found to be slightly better for feeding this converter from a 52-ohm coaxial cable. Improved performance with this type of converter may be obtained, when space is available, by adding an additional 6J4 broad-band amplifier stage ahead of the one shown, using identical circuit constants.

Figure 11. VIEW SHOWING THE 28-MC. BROAD-BAND CONVERTER INSTALLED IN THE DYNAMOTOR WELL OF A BC-348P.

With a similar installation of the 50-Mc. converter in this manner difficulty was encountered with interference from signals getting through in the 14 to 18 Mc. range. If this difficulty is encountered it is suggested that a separate connector be mounted for the 50-Mc. antenna, and that the switch on the panel be used only for changing the input of the receiver from the antenna post on the front to the coaxial cable from the converter. Then, with the low-frequency antenna removed from the front terminal the pickup of signals in the 14 to 18 Mc. range should be sufficiently reduced.

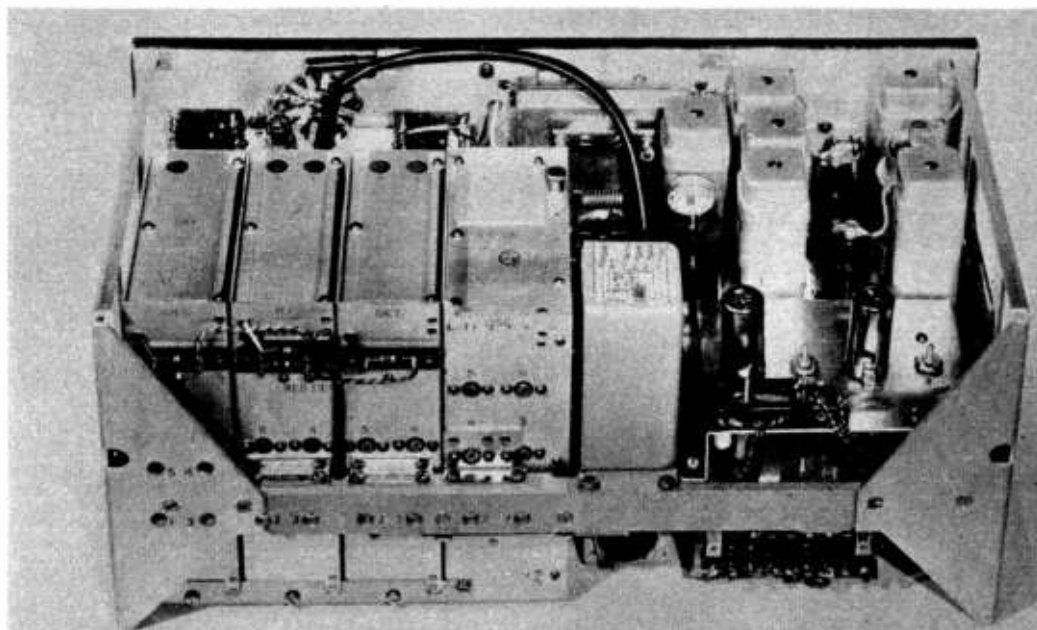

V-H-F and U-H-F Receiver Construction

ALTHOUGH it is relatively easy to build receivers for use up to about 200 Mc., receivers for the frequency range above 300 Mc. are difficult to construct in the home workshop. In fact, obtaining operation with conventional tubes at frequencies as high as the 420 to 450 Mc. band is impracticable. However, tubes of the acorn type can be used in conventional circuits at this frequency range if sufficient attention is given to the problem of obtaining low lead inductances. Miniature tubes such as the 6J6 may be used as mixers at frequencies as high as 600 Mc., but if we go much above this frequency limit with conventional negative-grid circuits the use of disc-seal tubes such as the lighthouse series becomes necessary.

The practicability of conventional coil-capacitor tank circuits becomes questionable at frequencies above about 300 Mc. One reason for this condition lies in the fact that the inductance of the stator plates becomes of the same order of magnitude as that of the coil required to hit such a frequency range. One way of extending the range of the coil-capacitor circuit is to use a tank circuit whereby the tank inductance is split and one half placed on either side of the tuning capacitor. Through this expedient it is possible to cause the currents in the stator plates to flow in opposite directions from the two halves of the tank coil and hence to reduce the effective inductance of the capacitor. The use of the new midget butterfly u-h-f tuning capacitors is a further help in extending the frequency range since the rotor of the butterfly capacitor has a much lower effective inductance than the rotor of the conventional split-stator tuning capacitor. A tank circuit using one of the new midget butterfly capacitors in conjunction with a split tank inductor is shown as the tuned circuit for the 6J6 mixer stage in the u-h-f superheterodyne converter shown in this chapter.

Through the use of an arrangement whereby the tank inductance is made up of continuations of the stator plates of a butterfly tuning capacitor the frequency range of a coil-capacitor circuit may be extended to frequencies as high as 3000 Mc. Such tank arrangements are called "butterfly" circuits and have been discussed in Chapter 5. An example of such a tank circuit is shown in Figure 36 of Chapter 5.

Even though the practicability of the coil-capacitor circuit may be extended well into the u-h-f range through the use of the butterfly arrangement, much better tank circuit Q may be obtained in the u-h-f range through the use of short sections of coaxial line or through the use of the resonant cavity. The shortened coaxial line is most practicable in the frequency range from perhaps 200 to 2000 Mc. The resonant cavity becomes practicable at frequencies of the order of 1500 Mc. and above about 2500 or 3000 Mc. it becomes the most satisfactory sort of resonant circuit.

The frequency range of the coaxial tank circuit when operating with disc-seal tubes may be extended considerably through the use of $\frac{3}{4}$ -wave lines in either the grid or the plate circuit. This expedient becomes useful when the nodal point for a $\frac{1}{4}$ -wave line would fall inside the tube structure. If a $\frac{1}{4}$ -wave line may be used in one circuit satisfactorily, then a $\frac{3}{4}$ -wave line may often be used in the other circuit connected to the tube and still obtain satisfactory operation.

The most practicable type of low-power oscillator for frequencies greater than about 750 Mc. is the reflex klystron. This tube type is available in a large range of frequencies of operation up through the 20,000-Mc. range. Such tubes are very effective as the local oscillator in a receiver, and they may be used for transmission with highly directive antennas over moderate line-of-sight distances.

Mixers for frequencies above perhaps 600 Mc. can most

Figure 1.
FRONT VIEW OF THE SUPER-
REGENERATIVE RECEIVER.

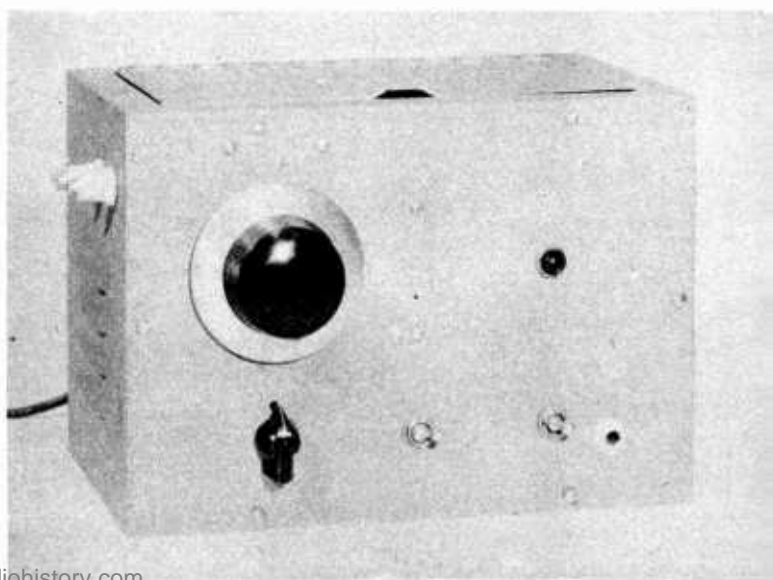

satisfactorily be of the silicon-crystal type. The 1N21B crystal, of which large quantities are available on the surplus market, is specifically designed for use as a mixer in the 3000-Mc. range. Such crystals may be used, however, on the amateur 1200-Mc. band as mixers as well as on the higher frequency bands. In fact, at frequencies as low as the 420-Mc. band the crystal mixer begins to give a good account of itself. When used in a mixer circuit the 1N21B is normally fed sufficient local-oscillator voltage so that from 0.4 to 0.8 milliampere of rectified crystal current is flowing.

SUPERREGENERATIVE RECEIVER FOR 2, 1 1/4, AND 3/4 METERS

The difficulty of constructing a receiver for the 144-Mc., 235-Mc., and 420-Mc. bands can be greatly reduced through the use of one of the excellent oscillator units manufactured by the Cardwell Mfg. Co. These oscillators are designed to use a relatively new u-h-f acorn tube called the 6F4 and are provided with coil sets for each of the three above bands. However, in the case of several of the coil sets tested in the laboratory it was impossible to reach a frequency much above 400 Mc. on the highest frequency coil. Consequently, new coils were made for the oscillator from strips of copper. In the process of determining the exact size of the coils for the 420 to 450 Mc. band it was found that there is comparatively little difficulty in getting the oscillator up to a frequency as high as 570 Mc. using short pieces of copper strap at each end of the oscillator assembly. Also, it is very simple to use a slightly

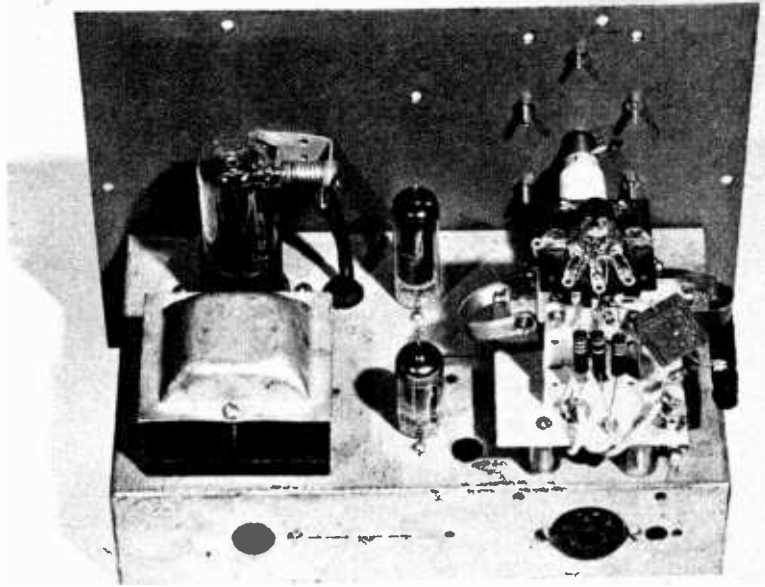

Figure 2. REAR VIEW OF THE SUPERREGENERATIVE RECEIVER SHOWN REMOVED FROM ITS CABINET.

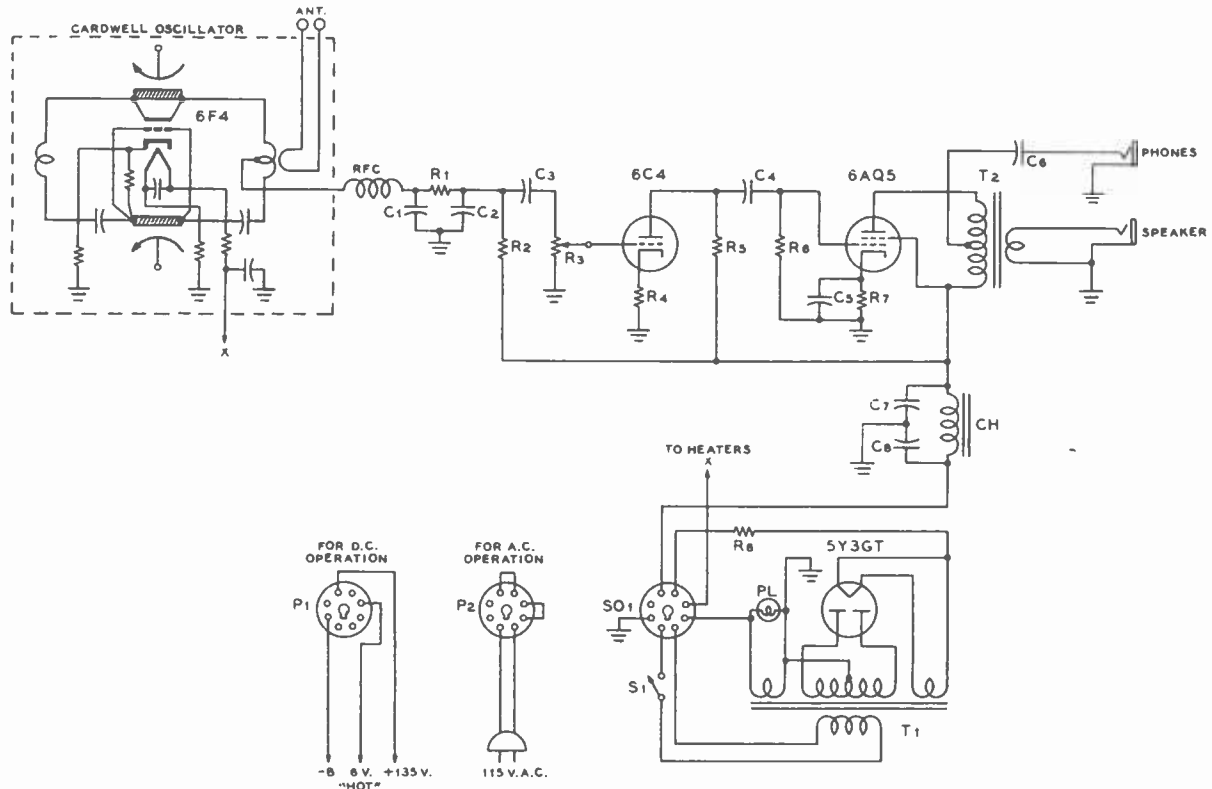

Figure 3.

SCHMATIC OF THE 2, 1 1/4, AND 3/4 METER SUPERREGEN.

- C₁—0.005-μfd. midget mica
- C₂—500-μfd. midget mica
- C₃—0.003-μfd. midget mica

- C₄—0.05-μfd. 400-volt tubular
- C₅—25-μfd. 25-volt elect.
- C₆—8-μfd. 450-volt elect.
- C₇—16-μfd. 450-volt elect.

- C₈—8-μfd. 450-volt elect.
- R₁—1000 ohms 2 watts
- R₂—22,000 ohms 2 watts
- R₃—500,000-ohm potentiometer
- R₄—3300 ohms 2 watts
- R₅—100,000 ohms 2 watts

- R₆—220,000 ohms 1/2 watt
- R₇—270 ohms 2 watts
- R₈—5000 ohms 10 watts
- CH—10-hy. 55-ma. filter choke

- T₁—55-ma. power trans., 6.3 v. fil.
- T₂—Midget pentode output transformer
- RFC—U-h-f r-f choke
- Oscillator assembly—Cardwell 20,024

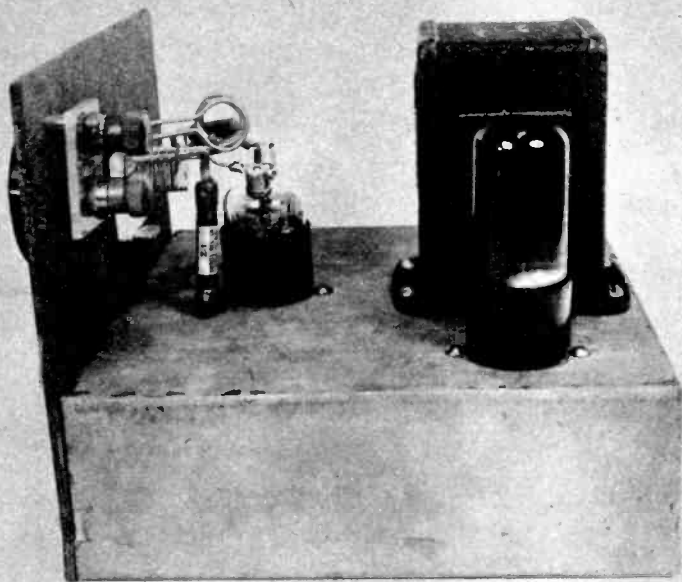

Figure 4.
SIDE VIEW OF THE 144-Mc. SUPER-
REGENERATIVE RECEIVER.

shorter piece of strip than the dimensions given below for operation on the 460-Mc. citizens-radio band.

The actual inductors used for the 420-450 Mc. band can be seen in the photograph of Figure 1. The two inductors are the same and are cut from 1/32-inch copper. The strips are 3/8 inch wide and 2 3/4 inches long before bending. The two mounting holes are spaced 2 3/8 inches on centers. After the strips have been cut and the holes drilled they are bent into the shape shown in Figure 1, and then mounted on the oscillator assembly. The plate-voltage connection for the oscillator is soldered to the center of the loop on the same side as for the coils supplied with the unit.

Checking Frequency The frequency of the superregenerator may be checked first with the aid of a pair of lecher wires. With a conventional lecher frame having a pair of no. 14 wires spaced about 1 1/2 inches the successive drop-outs in the hiss of the receiver should come at approximately 40 inches for the 144-Mc. band, at 25 inches for the 235-Mc. band, and at somewhere between 13 and 14 inches for the 420 to 450 Mc. band. For this test the ends of the wires of the lecher frame should be coupled to the antenna terminals of the receiver.

Figure 5.
UNDERCHASSIS VIEW OF THE 144-Mc. SUPERREGEN-
ERATOR.

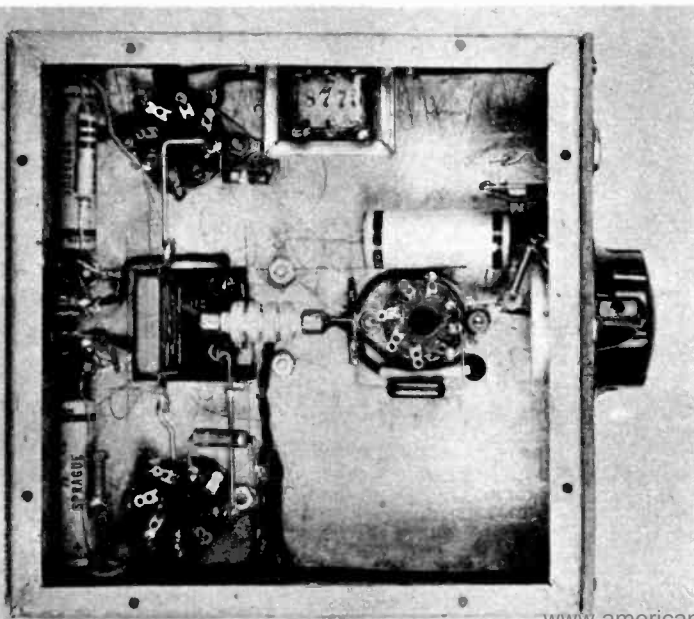

A more accurate check for calibration of the receiver on the 420-Mc. band may be obtained by listening to the third harmonic of a 144-Mc. transmitter, since the third harmonic of the 144-Mc. to 148-Mc. band falls inside the band limits of the 420 to 450 Mc. band. An accurate check on the center of the 235-Mc. band may be obtained by listening to the 8th harmonic of a transmitter on 29.7 Mc.

Construction The only critical portion of the superregenerative receiver is the oscillator portion which comes as an assembled unit. In the particular receiver shown the power supply is placed upon one end of the chassis, with the filter components underneath, the oscillator is placed upon the other end, and the audio amplifier is placed in the center of the chassis.

Provision has been made for feeding either a pair of phones from the center tap of the output transformer, or for feeding the voice coil of a dynamic loudspeaker from the secondary of the output transformer. Although the unit has a 115-volt a-c power supply built on the chassis, provision has been made for operation of the receiver from batteries or from a storage battery and a vibrator pack merely by inserting an octal plug with the proper connections into the socket on the rear of the chassis.

The receiver is mounted in a small cabinet housing, with the antenna terminals consisting of a pair of feedthrough insulators on the side of the cabinet. A length of stiff hookup wire running from the antenna terminals with a two-turn loop on the end is coupled to the tank coil of the superregenerative detector.

SIMPLE 144-Mc. SUPERREGENERATIVE RECEIVER

If operation only on the 144-Mc. band is desired of a superregenerative receiver the construction problem is greatly simplified. Figures 4 and 5 illustrate a very simple superregenerator which may be constructed with a minimum of difficulty of simple materials.

The receiver employs a HY615 tube as the superregenerative detector followed by a 6C5 and a 6F6 audio amplifier to drive the loudspeaker. There are only two controls, a main tuning dial and a regeneration control which also serves as the volume control. The regeneration control knob is directly under the main dial where it may be seen clearly in Figure 5. The jack to the left of the regeneration control receives the plug from a permanent-magnet-type loudspeaker. The output transformer to couple the 6F6 to the loudspeaker has been included in the receiver. However, if the particular loudspeaker used is equipped with an output transformer the plug may be connected to the plate and screen of the 6F6 tube.

Construction The layout of components is clearly visible in the photographs of Figures 4 and 5. The two coil L_1 and L_2 , tuning capacitor C_1 and the r-f choke RFC, are mounted behind the panel directly in back of the main tuning dial and as close to the top cap terminals of the HY615 as is possible. This type of construction results in short leads which are so important in successful v-h-f apparatus. The antenna terminals are mounted on a small polystyrene strip supported from the rear corner of the front panel.

For best results coil L_2 should be soldered directly to the two terminals of capacitor C_1 , as shown in the photographs.

Operation When the superregenerative receiver is in operation a continuous hiss will be heard from the loudspeaker. This noise disappears completely when a strong signal is tuned in and is reduced considerably by weaker signals. The

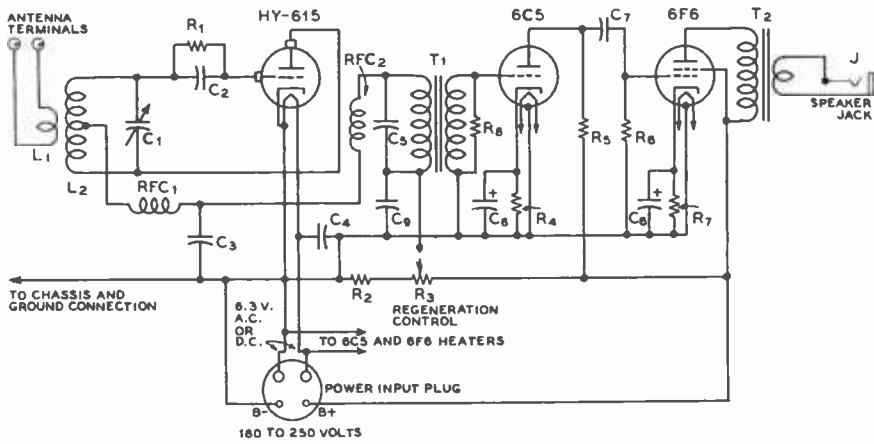

SCHEMATIC OF THE SUPERREGENERATIVE RECEIVER

FIGURE 6.

- C₁—15- μ fd. ultra-midget variable
- C₂—100- μ fd. midget mica
- C₃—0.001- μ fd. midget mica
- C₄—0.005- μ fd. midget mica
- C₅—0.002- μ fd. midget mica
- C₆—10- μ fd. 25-volt elect.
- C₇—0.01- μ fd. mica
- C₈—25- μ fd. 25-volt elect.
- C₉—0.25- μ fd. 400-volt tubular
- R₁—10,000 ohms 1/2 watt
- R₂—100,000 ohms 1/2 watt
- R₃—100,000-ohm potentiometer
- R₄—2200 ohms 1 watt
- R₅—47,000 ohms 1 watt
- R₆—470,000 ohms 1/2 watt
- R₇—350 ohms 2 watts
- R₈—100,000 ohms, 1/2 watt
- L₁—Single turn of no. 18 enam. 1/2-inch dia. and near grid end of L₂.
- L₂—For 2 meters: 2 turns no. 14 tinned, 1/2-inch dia., turns spaced 1/4 inch. Tap 1/2 turn from plate end.
- J—Open-circuit phone jack
- RFC₁—Ohmite Z-1 v-h-f choke
- RFC₂—2.5-mh. 125-ma. r-f choke
- T₁—2-to-1 ratio interstage trans.
- T₂—Universal output transformer

best position of regeneration control R₃ will be that which gives strong signals with best voice quality and lowest hiss.

The spacing between the two coils L₁ and L₂ must be adjusted by bending L₁ to or away from L₂ until the point is found where the antenna has the least effect upon the receiver. When coupling is too close a dead spot in the tuning range will be found at one or more points on the dial. Signals will disappear at these dead spots; hence it is undesirable to have them within the normal tuning range of the receiver. When the coupling is of the proper amount no such dead spots will occur within that part of the tuning range of the amateur bands, although they will probably appear outside of this range on either one side or the other.

The operation of a superregenerative receiver causes the radiation of a signal which may produce serious interference in the receivers of other stations in the immediate vicinity. It is therefore advisable to use the smallest amount of voltage on the HY615 detector which will give satisfactory reception.

U-H-F SUPERHETERODYNE CONVERTER

If serious work is contemplated on the frequency bands of 144 Mc. and above a superheterodyne receiver is the only satisfactory answer. Aside from the fact that the superregenerative is likely to cause serious interference to local stations working on the same band, the fact remains that the superregenerator is a less satisfactory receiver from all standpoints except simplicity for u-h-f work. The superregenerator is a poor receiver of FM signals unless they have a large deviation, and although such a receiver is satisfactory for reception of AM signals, it does not have as good a signal-to-noise ratio and has far less selectivity than a superheterodyne. Of course the point may be made that a large number of the signals on the u-h-f bands do not have sufficient stability to warrant the use of a selective superheterodyne receiver. But the use of a superheterodyne will permit greatly improved reception of those signals having good stability. Also, if the converter is

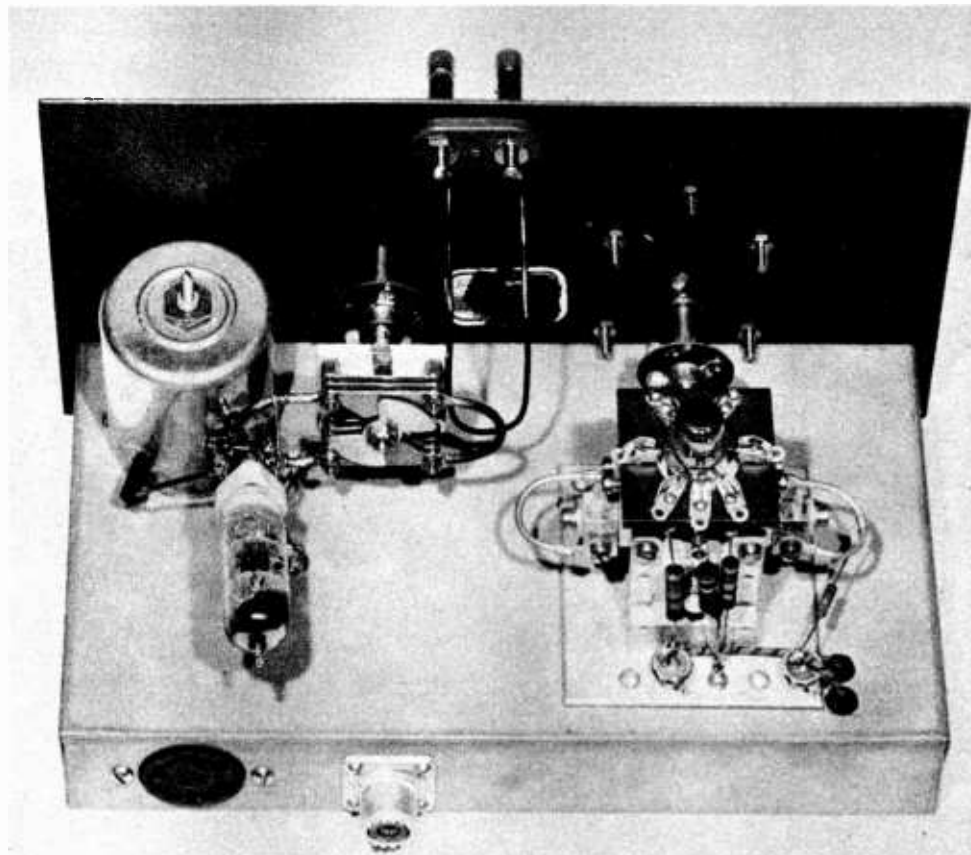

Figure 7.
REAR VIEW OF THE U-H-F CONVERTER.
The coils for the 420-Mc. band are in place in this photograph.

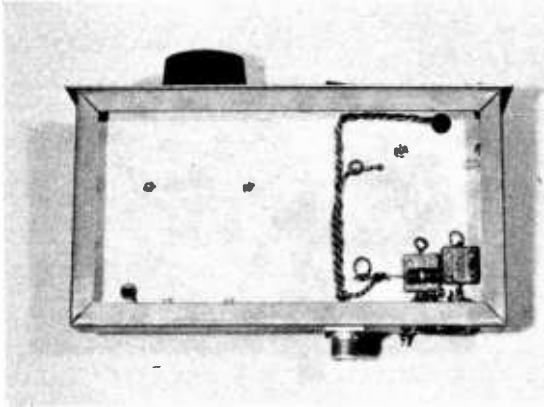

Figure 8.
UNDERCHASSIS VIEW OF THE CONVERTER.

operated ahead of a receiver having a broad i-f channel satisfactory reception may be obtained even from the modulated-oscillator type of transmitter if the operator of the station is requested to turn down the gain on the transmitter, and if the signal is then received as a wide-band FM signal.

The superheterodyne converter shown in Figures 7 and 8 has been designed for operation into a receiver operating somewhere in the 42 to 54 Mc. range and having both broad i.f. and provision for the reception of FM signals. One of the most satisfactory types of tail end for use with this converter is an FM receiver or converter of the type designed for use on the pre-war FM band from 42 to 50 Mc. A large number of these receivers and converters are not being used at this time, since the FM band has been moved up to the 88 to 108 Mc. range, hence their use as an i-f to audio system for the converter being described is an excellent application.

Circuit of the Converter Since the oscillator units tested covered the approximate frequency range from 360 to 410 Mc., this range may be used unchanged for operation into an i-f channel of approximately 50 Mc. in covering the 420-Mc. band. Trimming to the exact frequency range desired is discussed in the instructions furnished with the oscillator units and involves merely the adjustment of the setting of two screws.

One of the tank coils of the oscillator is inductively coupled to the grid tank on the 6J6 mixer stage. The stage is operated with the grids in push-pull and the plates in parallel with a 50-Mc. tank circuit as a load for the plates of the tube. The 50-Mc. tank is link coupled to a coaxial cable which runs over to the receiver. The input circuit of the receiver is, of course, tuned to 50 Mc. or to some frequency in this range which has been chosen as the first i.f. of the complete receiving system.

The tank coils for the grid of the mixer stage in the converter were made from no. 12 bare copper wire. For the 420-

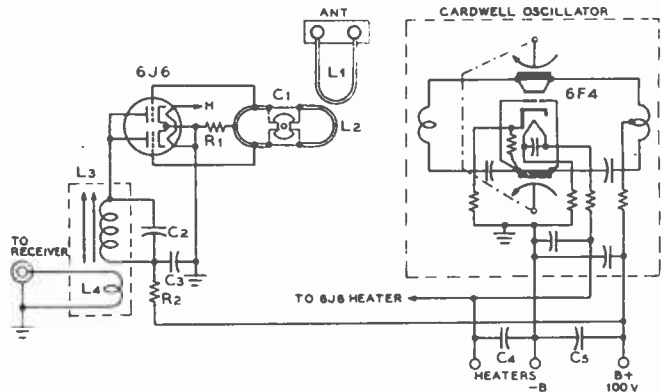

Figure 9.
SCHEMATIC DIAGRAM OF THE U-H-F CONVERTER.

C ₁ —8- μ fd. midget butterfly	R ₂ —100 ohms 2 watts
C ₂ —50- μ fd. midget mico	L ₁ —One-turn antenna loop
C ₃ , C ₄ , C ₅ —0.003- μ fd. midget mico	L ₂ —See text
R ₁ —50,000 ohms $\frac{1}{2}$ watt	L ₃ —7 turns on $\frac{1}{2}$ -inch dia. form Oscillator assembly

Mc. band the coils each consist of half-loops, with the loops extending out about $\frac{7}{8}$ inch on each side of the tuning capacitor. The grids of the 6J6 are tapped up on the coil on one end of the capacitor about one-third the distance from the center of the coil to the tuning capacitor. Connections to the ends of the no. 12 wire conductors have been made by pounding the ends of the wire flat and then drilling for the screws on the stator of the capacitor. The coils for the 235-Mc. and 144-Mc. band are made in the same general way except that the 235-Mc. coil consists of 2 turns on each side of the tuning capacitor about one-half inch in diameter and the 144-Mc. coil consists of 4 turns on each side. The inductance of the coils may be trimmed by squeezing and the sharpness of resonance of the grid circuit of the mixer may be varied by adjusting the distance either side of the center of the tank coil where the grids of the 6J6 are tapped.

The output circuit coil L₂ is tuned by turning up the gain on the receiver into which the converter operates and then adjusting the tuning slug for the greatest noise level. The oscillator and mixer circuits are tuned separately, the signal being tuned in by the oscillator and then C₁ is peaked for maximum signal strength. The tuning range of C₁-L₂ is quite large so that some pulling of the oscillator frequency will probably take place when the mixer grid circuit is tuned to its lowest frequency. A slight increase in the hiss level will be noticed, with an antenna coupled to the mixer grid, when the mixer grid circuit is tuned through resonance—this frequency is of course the intermediate frequency chosen plus the oscillator frequency.

H-F Exciters and Low-Power Transmitters

IN ASSEMBLING an amateur station it is wise, whenever practicable, to purchase and construct units toward a definite goal. This is particularly true in regard to the transmitting equipment. Thus it is wise to start out with a simple transmitter which may later serve as the exciter for a higher-powered r-f amplifier. In most cases the first transmitter will be crystal controlled, but provision should be made for the addition of an external variable-frequency oscillator at a later date. If a rack-mounted transmitter is the ultimate objective, the transmitter which is later to be used as an exciter should be mounted on a standard rack panel.

V-f-o operation is much to be desired on all the bands below 54 Mc. The use of a v.f.o. is almost a necessity for operation in the phone bands below 29.7 Mc. and for c-w operation on the 14-Mc. band. But provision for the use of one or more crystals alternative to the v.f.o. should be made for edge-of-band operation and for working on spot frequencies for nets.

Transmitters for the beginning amateur usually are constructed on a wood baseboard or frame so that when more experience and knowledge is acquired the units may be disassembled for components with as little loss as possible from scrapped panels and chassis.

SIMPLE C-W TRANSMITTER FOR 3.5 AND 7.0 MC.

Figures 1, 2, and 3 show a simple and stable c-w transmitter of the type frequently used by newcomers when first getting on the air. All components required in the set are quite inexpensive. While a keyed crystal oscillator working directly into

the antenna system could be used, the additional stability, power output and absence of keying chirps usually encountered when the crystal oscillator is keyed directly, make the extra few parts well worthwhile.

The Circuit A type 6J5 tube operating as a grid-plate Pierce oscillator is fed into a 6L6 power amplifier or frequency multiplier. While glass tubes have been shown, metal ones would be as satisfactory if pin no. 1 of the metal tubes is connected to the ground bus. The transmitter will deliver between 10 and 15 watts to the antenna on the 80-meter band and approximately 5 to 8 watts on the 40-meter band with the same crystal and coil being used on both bands.

Construction Both the power supply and the transmitter are mounted on simple wooden chassis constructed of "battens" having dimensions of $1\frac{3}{4} \times \frac{3}{8}$ inch. More than enough material to build these two chassis can be obtained from a lumber mill for around twenty cents. The pieces are nailed together with one-inch long thin nails called brads. Several coats of gray paint improve the appearance considerably. In the units illustrated in Figures 1 and 2 the power supply chassis is 8 inches long and $4\frac{3}{4}$ inches wide and $2\frac{1}{8}$ inches high. The transmitter chassis is 14 inches long with the other dimensions being the same as the power supply.

As a safety precaution the circuit has been designed so that no parts above the chassis have high voltage on them. Connections between the transmitter and the power supply are made by means of Fahnestock clips bolted to the rear of the chassis.

Figure 1.
THE 40-80 METER TRANSMITTER AND POWER SUPPLY.

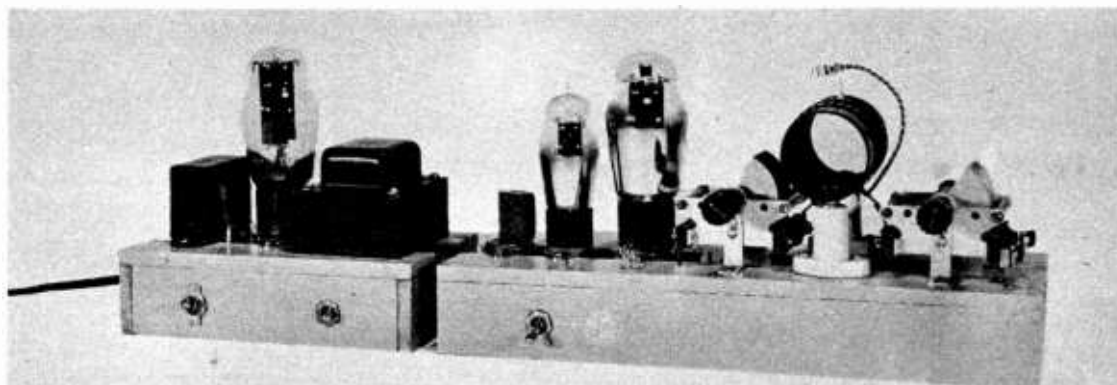

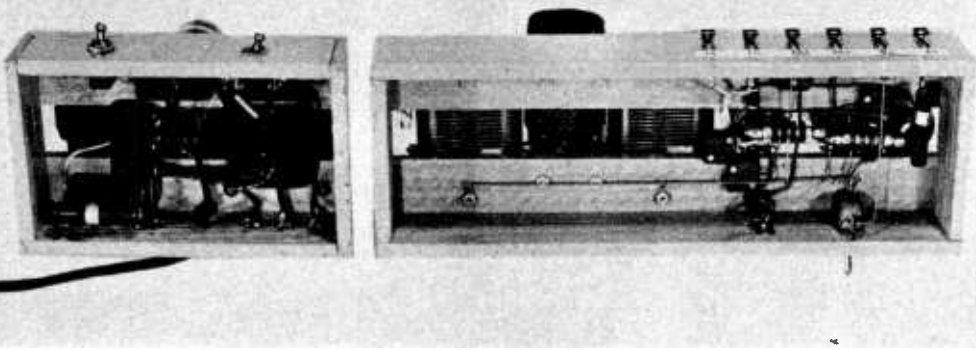

Figure 2.
BOTTOM VIEW OF THE 80-40
METER TRANSMITTER.

No high voltage appears above the chassis. Note busbar to which all grounds are made.

Circuit Details A dial lamp of the type used with 2-volt battery sets and drawing 60 ma. is incorporated as a tuning indicator. It may be seen in front of the 6L6 tube in Figure 1. A regular 0-150 d-c milliammeter is, however, much to be preferred for making more accurate adjustments. Antenna and ground connections to the transmitter are made to two Fahnestock clips attached to the rotor and stator respectively of the righthand variable capacitor.

No additional antenna tuning network is required when using a "pi" network tuning system. However, a good ground must be connected to the B- lead of the transmitter. On the 80-meter band both the crystal oscillator and the power amplifier operate on the crystal frequency. On 40 meters the crystal continues to operate on 80, but half the turns in the coil L₁ are shorted out by the flexible shorting wire and clip seen extending over the coil in Figure 1, permitting the power amplifier to double to the second harmonic of the crystal frequency. To permit operation within the limits of the 40-meter band, however, the crystal frequency must be between 3500 and 3650 kc.

Tuning the Transmitter Apply plate voltage to the transmitter and hold the key down. Then, watching the indicator light, rotate C₃ very slowly until the light dims and then comes back as the capacitor is rotated further. The center of this dip is the correct adjustment of C₃. If no dip is found, rotate capacitor C₃ one way or the other and try again until the point of dip is found. A loop of wire connected to a flashlight or dial light bulb and held near the coil will light up brightly as will a small neon bulb touching the antenna

terminal. Connect the antenna to the antenna terminal and retune C₃ for either minimum dip in the bulb or maximum brightness of the lamp which is coupled to the tank circuit by means of the loop. If the antenna is a half wavelength long tune both capacitors for maximum brilliance in the neon bulb, touching the antenna terminal. If the antenna is a quarter wavelength long or shorter, use the loop as an indicator that the greatest amount of energy is present in the output tank circuit. The use of a milliammeter in place of the 60-ma. dial lamp greatly facilitates this tuning procedure since it permits a more accurate indication of how the antenna is drawing power from the amplifier. As the antenna loading increases the current reading at minimum dip will go up, while the dip itself will be found to be less and less pronounced. With 350 volts from the power supply the amplifier when properly loaded will draw between 60 and 70 ma. Plate voltage on the oscillator and screen voltage on the 6L6 will be 130 volts under these conditions.

For 40-meter operation follow exactly the same tuning procedure except that half of the coil should be shorted out by means of the flexible lead attached to one end of the coil. Do not look for a dip in the indicator light but tune instead for maximum brilliance in the lamp which is connected to the load.

7C5/807 TRANSMITTER EXCITER

The transmitter shown in Figures 4, 5, and 6 is capable of approximately 40 watts output on all bands from 80 through 10 meters. Plug-in coils are used both in the plate circuit of the oscillator-multiplier and the 807 final amplifier.

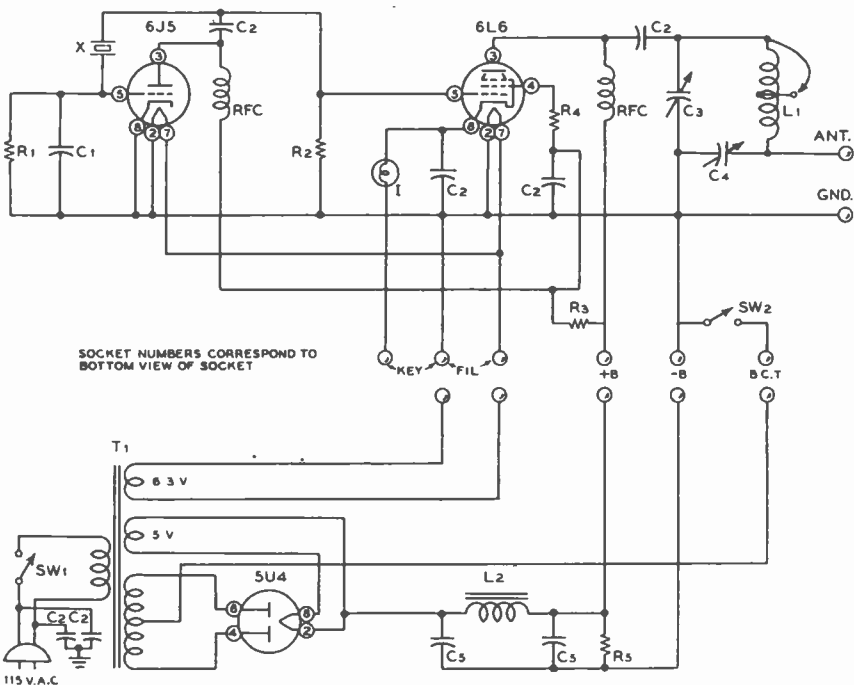

SOCKET NUMBERS CORRESPOND TO
BOTTOM VIEW OF SOCKET

SCHEMATIC OF THE 6J5-6L6 TRANSMITTER

Figure 3.

- C₁—50-μfd. midget mica
- C₂—0.002-μfd. midget mica (6 needed)
- C₃, C₄—260-μfd. variables (2 needed)
- C₅—8-μfd. 450-volt elect. (2 needed)
- R₁—22,000 ohms, 1/2 watt
- R₂—47,000 ohms, 1/2 watt
- R₃—25,000-ohm 10-watt wirewound
- R₄—47 ohms, 2 watts
- R₅—50,000 ohms, 20 watts
- I—60-ma. dial lamp bulb
- RFC—2.5-mh. 125-ma. r-f choke
- SW₁, SW₂—S.p.s.t. toggle switch
- T₁—700 v. c.t., 90 ma.; 5 v. 2 a.; 6.3 v. 3.5 amp.
- L₁—20 turns of hookup wire closewound on 2-inch tube, tapped at 10th turn
- L₂—8-hy. 85 to 100 ma. choke
- X—80-meter crystal

Circuit The transmitter consists of a 7C5 crystal oscillator in a hot-cathode Colpitts circuit. The plate circuit of the crystal oscillator may be tuned to two, three or four times the crystal frequency, or the oscillator may be run straight through on the crystal frequency. The 807 amplifier may be run either as a doubler or as a straight amplifier on the excitation frequency. Any crystal from 80 through 20 meters may be employed in the oscillator stage so that it is possible to run the 807 as an amplifier on all amateur bands if the proper crystal frequency is used for the 7C5.

Construction The transmitter is built on a 7 x 17 x 3 inch metal chassis. Open chassis type of construction has been employed, but the unit may be enclosed in a cabinet or mounted behind a standard relay-rack panel if it is so desired. The oscillator coils, which are wound on 1/4 inch diameter polystyrene forms, are plugged into a 4-contact socket and covered by the 2 1/2 inch diameter metal shield can seen directly behind the 7C5 tube in Figure 4. This shield can is held to the chassis by four thumb screws and is replaced each time the oscillator coil is changed. The manufactured plug-in coils for the 807 amplifier may be of the fixed link or variable link type and are mounted in the jack base which is supported on ceramic pillars just to the right of the 807 amplifier. The 80-meter coil is shown in place in the photograph. Another 2 1/2 inch diameter shield can surrounds the 807 tube. Both of these shield cans are important to proper operation of the transmitter and must not be omitted in construction of the equipment. Jacks J₁ and J₂ are mounted directly through the front drop of the chassis since they do not require insulation. Jack J₃, however, is in the high voltage plate lead to the 807 and must be insulated from the chassis. This jack may be seen mounted on a small lucite sub-panel under the chassis and slightly back from the front in the photograph of Figure 5. The coaxial output fitting J₄ is mounted directly on the rear drop of the chassis.

Each of the tuning capacitors C₁ and C₁₀ and the coupling capacitor C₂ likewise must be insulated from the chassis. Capacitors C₁ and C₂ are mounted on the small polystyrene sub-panel supported from the front drop of the chassis by four studs and are connected to the tuning dials through flexible

7C5-807 TRANSMITTER Oscillator Coil Table, L₁

80-METER BAND. 30 turns no. 20 d.c.c. wire closewound on a 1 1/2-inch diameter plug-in form.
40-METER BAND. 16 turns no. 20 d.c.c. wire on a 1 1/2-inch diameter plug-in form. Space to 1 1/2 inches.
20-METER BAND. 8 turns no. 20 d.c.c. wire on 1 1/2-inch diameter plug-in form. Space to 1 1/2 inches.
10- and 11-METER BANDS. 6 turns no. 16 enamelled wire on a 1 1/2-inch diameter plug-in form. Space to 1 1/2 inches.

couplings and bakelite rod. The amplifier tuning capacitor C₁₀ is mounted by long ceramic posts on top of the chassis and is tuned by means of the large bakelite knob seen in the top view photograph.

Operation With antenna disconnected from the transmitter, connect a jumper between the terminals 4 and 5 on the rear chassis terminal strip. Plug in a crystal and a coil combination which will deliver output on the desired band. Connect the power supply unit and apply plate voltage.

Insert a 0-10 d-c milliammeter into jack J₂ and tune capacitor C₁ for maximum deflection of the meter. Adjust capacitor C₂, readjusting C₁, until the maximum meter deflection is not more than 5 ma.

Connect a 0-100 or 0-150 d-c milliammeter in jack J₃ and adjust tuning capacitor C₁₀ for dip. Do not permit the transmitter to run very long in this condition since the screen of the 807 tube will be exceeding its dissipation rating. Coaxial transmission line from the antenna or antenna coupler may now be plugged into jack J₄ and C₁₀ returned to dip. The plate current with normal loading on the stage will be from 90 to 100 ma.

For c-w operation plug the key into jack J₁. For AM phone transmission remove the jumper terminals 4 and 5 on the rear chassis terminal strip and connect in its place the output leads from the external modulator unit. The amplifier will present a load impedance of approximately 5000 ohms to the modulator, and approximately 25 watts of average audio power will be required for complete modulation.

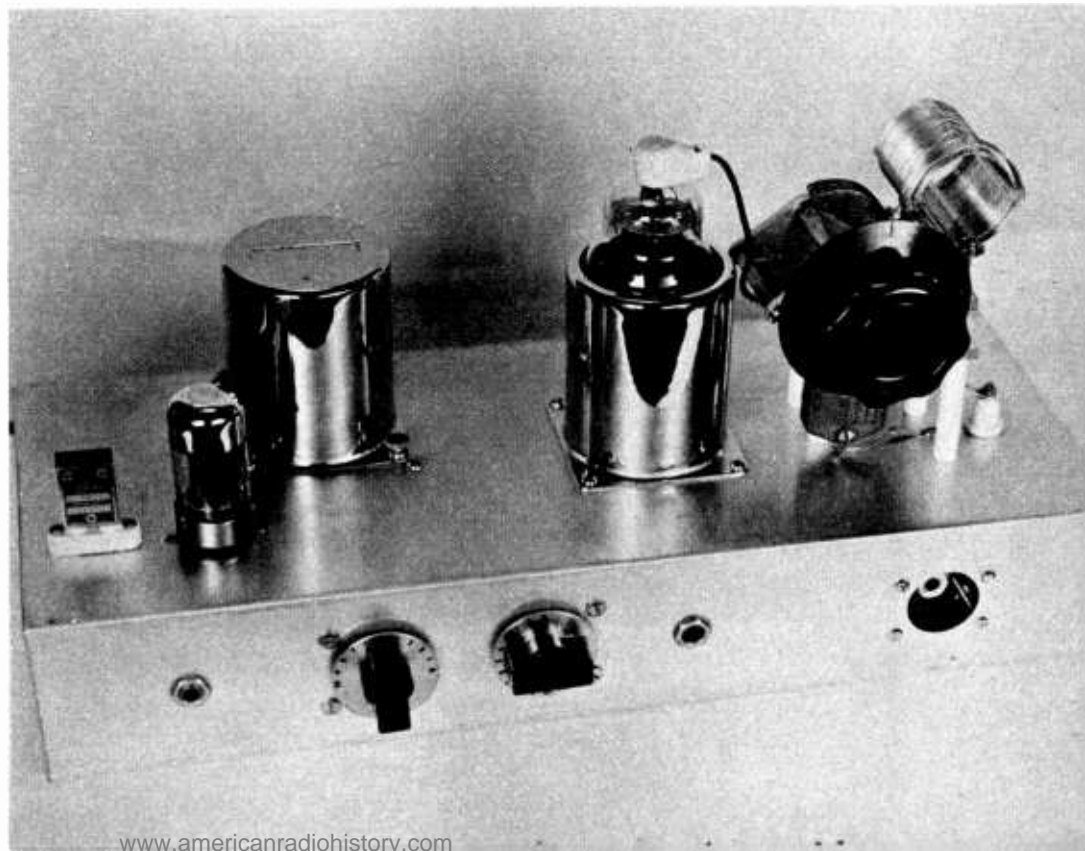

Figure 4.
TOP VIEW OF THE 7C5-807
TRANSMITTER.

The plate coil for the 7C5 is in the shield can behind and to the right of the tube. The jack for the plate milliammeter on the 807 is behind the hole on the front drop of the chassis.

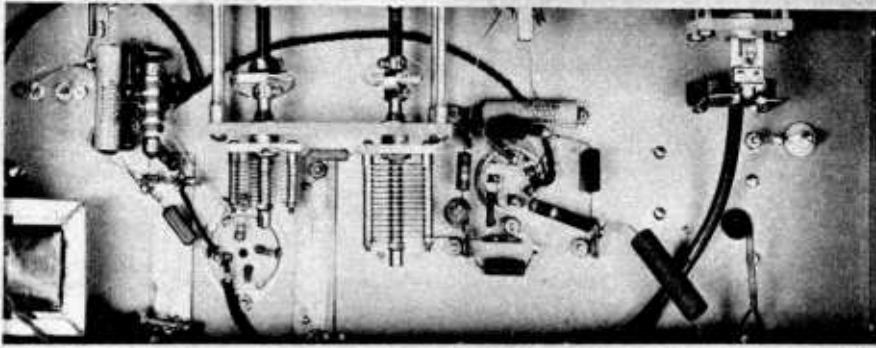

Figure 5.
UNDERCHASSIS VIEW OF THE
7C5-807 TRANSMITTER/EX-
CITER.

6L6-809 TRANSMITTER

The unit shown in Figures 7 and 8 is a modernized version of an exciter-transmitter that has proven very popular in previous editions of the RADIO HANDBOOK. It is capable of 30 to 60 watts output on all bands from 3.5 through 30 Mc. and will serve equally well as an exciter for driving a high-powered amplifier or as a transmitter when used to feed the antenna directly.

Circuit A 6L6 crystal oscillator of the hot-cathode Colpitts type is used with crystals from 3.5 to 10 Mc. The oscillator circuit is not satisfactory for use with harmonic cut crystals but will give excellent results with the conventional type of crystal which is normally used in the above frequency range. Plug-in coils, which are described in the accompanying coil table, are used in the plate circuit of the 6L6 oscillator multiplier. The 809 stage is neutralized and therefore may be used either as a straight amplifier or as a frequency doubler.

The output from the stage when doubling will be practically as great as when operating straight through, but the plate current will be found to run somewhat higher. A split-stator tuning capacitor has been used in the plate circuit of the 809 to insure that neutralization will be accurately maintained over the complete frequency range of the transmitter.

For normal operation of the equipment the 6L6 oscillator/multiplier is normally used to excite the 809 as a straight amplifier on all bands through 14.4 Mc. Crystals in the 3.5-Mc. band or the 7-Mc. band may be used with the 6L6 for this type of operation. With a 40-meter crystal in the grid circuit of the 6L6 and the plate circuit tuned to 14 Mc., the 809 will give quite satisfactory power output as a doubler to the 28-Mc. band. However, slightly greater power output can be obtained from the 809 by utilizing a crystal in the 9 to 10 Mc. region in the grid circuit of the 6L6 and tripling in the plate circuit of the 6L6 to the 28 Mc. band.

All tuning capacitors in the amplifier are operated at ground potential so far as plate voltage is concerned. So there is no

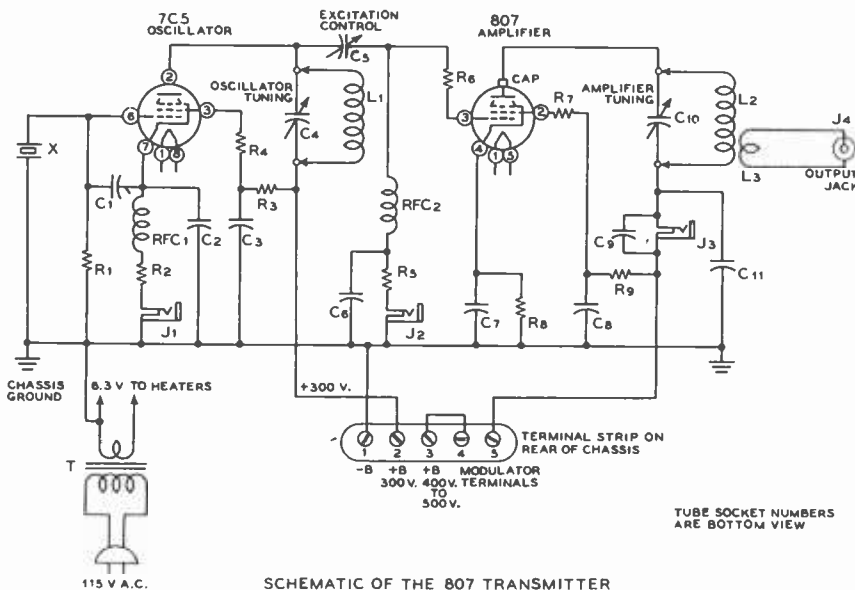

Figure 6.
C₁—40- μ fd. midget mica
C₂—250- μ fd. midget mica
C₃—0.002- μ fd. midget mica
C₄—100- μ fd. midget variable
C₅—50- μ fd. midget variable
C₆, C₇, C₈, C₉—0.005- μ fd. mica
C₁₀—100- μ fd. variable
C₁₁—0.005- μ fd. mica
R₁—100K 1/2-watt carbon
R₂—150-ohm 5-watt wirewound
R₃—10,000-ohm 1-watt carbon
R₄—47-ohm 1/2-watt carbon
R₅—10,000-ohm 1-watt carbon
R₆, R₇—47-ohm 1-watt carbon
R₈—300-ohm 5-watt wirewound
R₉—40,000-ohm 10-watt wirewound
RFC₁, RFC₂—2 1/2-mh. 125-ma. r-f chokes
T—6.3-volt, 2-amp. fil. trans.
J₁, J₂, J₃—Midget closed-circuit jacks
J₄—Coaxial r-f output jack
L₁—Osc. coil, see Coil Table
L₂, L₃—Manufactured end-link assembly

danger of electrical shock from these components. Shunt feed of the plate current is used on the 809 and series feed with a separate blocking capacitor is used for the plate current of the 6L6.

Keying of the exciter unit is accomplished in the cathode return of the 6L6 oscillator multiplier. With crystals of normal activity quite satisfactory keying for break-in operation may be obtained by this method.

Operating Conditions Normal plate voltage for the 6L6 stage is 300 volts. At this value of plate voltage and with normal tuning with an active crystal in the grid plate current will be approximately 35 ma. The grid current to the 809 stage varies from 20 to 30 ma. for normal tuning. The amplifier is designed for from 600 to 750 volts on the plate of the 809. If it is desired to run higher plate voltage than this on the amplifier stage, 150-watt coils may be substituted in the plate circuit of the 809 for the 50 watt series of coils used in the equipment shown. If this change is made, voltages up to 1000 may be used with an 809 tube in the final amplifier and voltages as high as 1250 may be used with an 811 tube substituted for the 809.

A 0-100 d-c milliammeter has been mounted on a small sloping panel atop the chassis of the unit. The meter switch in the center of the front panel selects the circuit whose current is to be measured by this instrument. When the meter is switched to the plate of the 6L6 or to the grid of the 809, its full scale reading is 100 ma. However, when the meter is switched to the plate circuit of the 809 stage, a shunt is placed across the meter so that its full scale reading then becomes 200 ma. The value of the shunt must be determined experimentally, but in the unit shown the shunt was made by using approximately a 1½ inch length of resistance wire obtained from a 50-ohm center tap resistor of the open-wound type frequently used as a filament center tap. The 809 stage may be amplitude modulated for phone operation as long as the tube is operating as a straight amplifier if the plate voltage on the tube is not allowed to exceed 600 volts under carrier conditions.

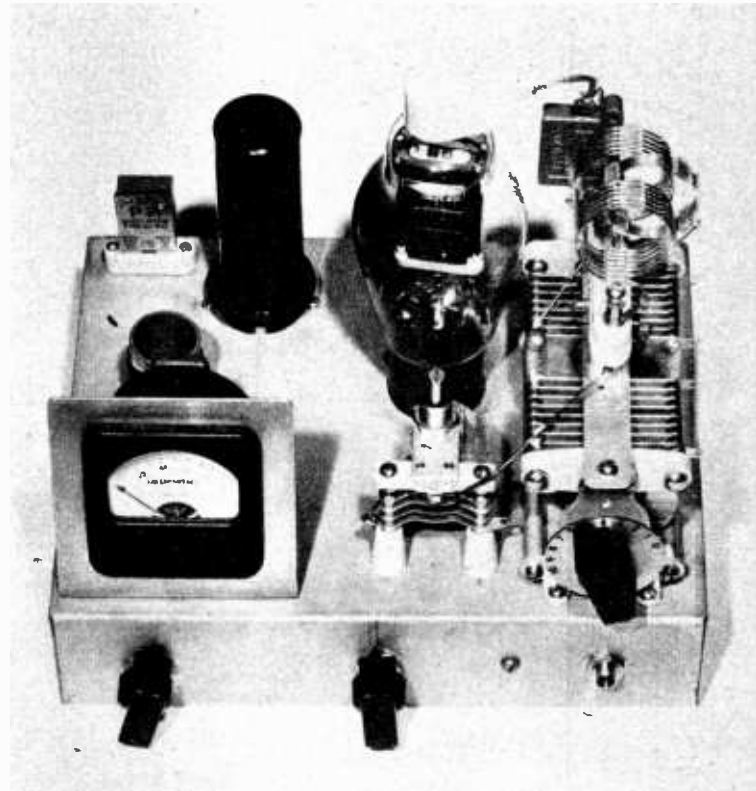

Figure 7.
TOP VIEW OF THE 6L6-809 TRANSMITTER.

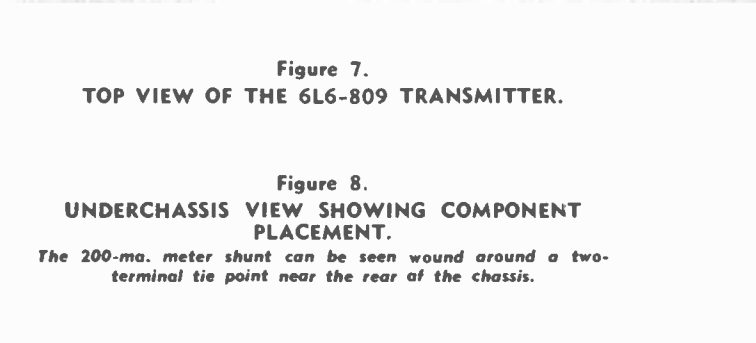

Figure 8.
UNDERCHASSIS VIEW SHOWING COMPONENT PLACEMENT.
The 200-ma. meter shunt can be seen wound around a two-terminal tie point near the rear of the chassis.

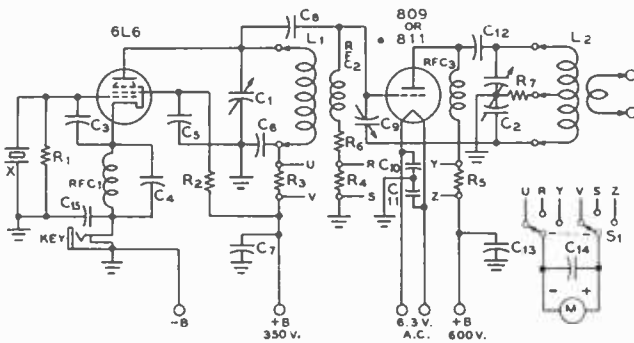
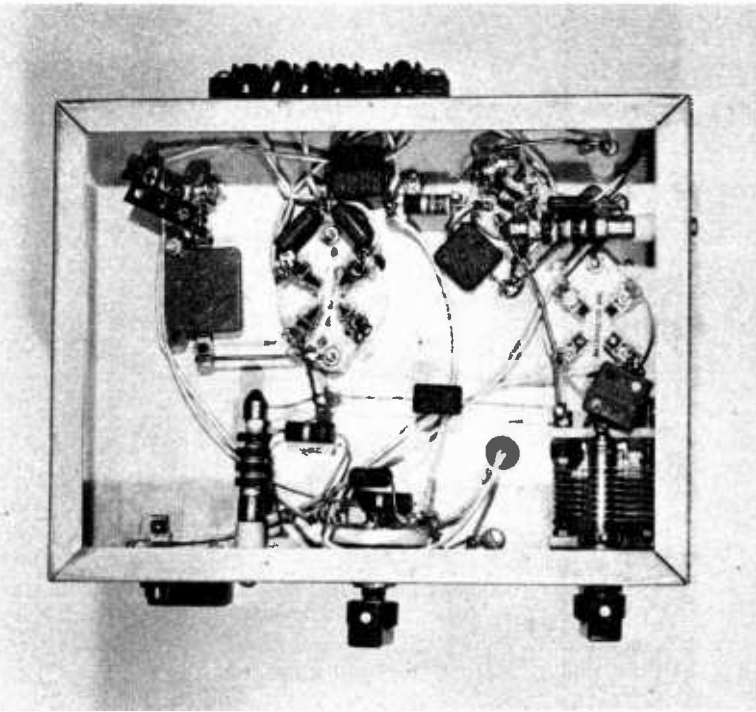

Figure 9.
SCHEMATIC DIAGRAM OF THE 6L6-809 TRANSMITTER.

- C₁—75-μfd. variable
- C₂—100-μfd. per section split stator variable capacitor
- C₃—10-μfd. ceramic capacitor
- C₄—100-μfd. midget mica
- C₅, C₆, C₇—0.003-μfd. midget mica
- C₈—100-μfd. midget mica.
- C₉—18-μfd. 3000-volt neut.
- C₁₀, C₁₁—0.003-μfd. midget mica
- C₁₂—0.002-μfd. 1250-volt mica
- C₁₃—0.001-μfd. 1250-volt mica
- C₁₄—0.003-μfd. midget mica
- C₁₅—0.01-μfd. midget mica
- R₁—100,000 ohms ½ watt
- R₂—47,000 ohms 2 watts
- R₃—100 ohms 2 watts
- R₄—100 ohms 2 watts
- R₅—1.0 ohm shunt resistor
- R₆—4700 ohms 2 watts
- RFC₁, RFC₂—2.5-mh. 125-ma. chokes
- RFC₃—1-mh. 300-ma. r-f choke
- L₁—80 meters: 43 t. no. 24 enam.
- 40 mtrs: 16 t. no. 24 enam. spaced to 1 inch
- 20 mtrs: 10 t. no. 24 enam. spaced to 1 inch
- L₂—50-watt center-link mfd. coils
- S₁—2-pole 3-position sw.



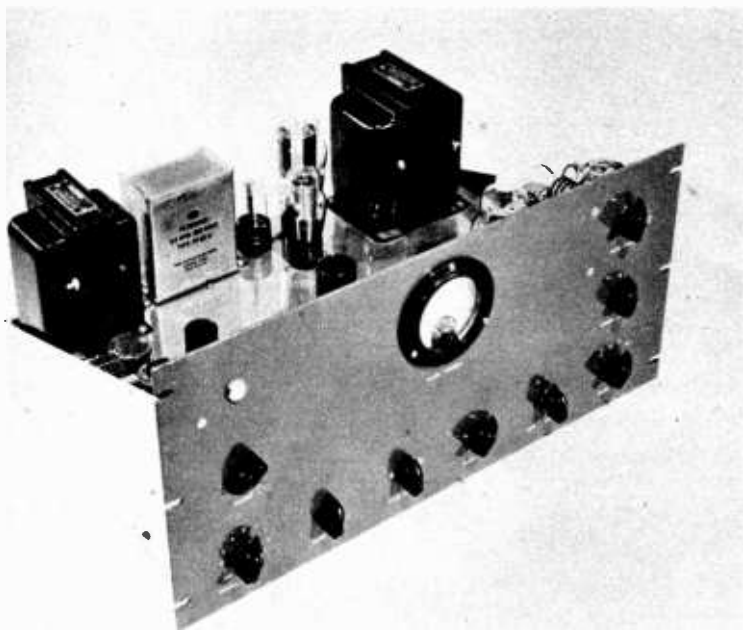

Figure 10.
LOOKING DOWN ON THE ALL-BAND BANDSWITCHING EXCITER

Decals have been used to identify the various controls.

807/HY69 ALL-BAND BANDSWITCHING EXCITER

The all-band exciter shown in Figures 10, 11, and 12 is capable of 25 to 30 watts output on all bands from 3.5 to 30 Mc. and will deliver approximately 15 watts on the 50 Mc. band with the output tube acting as a doubler. Either a HY69 or an 807 may be used interchangeably in the final stage. The socket for the final tube is connected in such a manner that no changes are required when changing from one tube type to the other. Crystals from 1.5 Mc. to 9 Mc. may be used for operation on any band from 3.5 through 54 Mc. as long as the output frequency is equal to or higher than the frequency of the crystal. The exciter has positions for 10 crystals and an eleventh position for v-f-o input. Excitation energy from the v.f.o. on any frequency from 1.5 to 9 Mc. may be used. Provision has been made for plate modulation of the final amplifier tube simply by removing the jumper on the terminal strip at the rear of the chassis and applying the output voltage from the modulator between these two points. A keying circuit has been provided which operates by blocking the grid of the 6AG7 first amplifier/multiplier when the key is up. With the particular values of resistance and capacitance shown in the keying circuit a very cleanly keyed signal without chirps or clicks will be obtained. For operation on telephony or in conjunction with an FM exciter the key positions on the terminal strip are shorted.

The Circuit The schematic diagram of the equipment is shown in Figure 13. A 6V6 tube, triode connected, is used as a cathode-follower crystal oscillator when crystal excitation is being used for the transmitter. A voltage regulator tube has been used to apply a constant potential of 105 volts to the plate of the crystal oscillator stage. Through this expedient complete absence of keying chirps is obtained even for straight c-w operation with crystal control on the 50 Mc. band. When v-f-o input is in use the 6V6 is inoperative

and the signal from the v.f.o. is used to excite the 6AG7 first amplifier or multiplier. An input voltage of only about 15 volts peak is required across the coaxial input line for full output from the 6AG7 stage. The plate circuit of the 6AG7 tunes from 3.1 to 9 Mc. and may be used in excitation position A to excite the grid of the HY69 or 807 final amplifier. In excitation positions B or C the 6AG7 output is used to excite the first 6L6 multiplier.

The plate circuit of the first 6L6 multiplier tunes from 7 to 14.9 Mc. and is normally used for exciting the 807 or HY69 over this frequency range. Any tendency toward self-oscillation in the 6L6 when it is operating as a straight amplifier on the 7-Mc. band is eliminated by inductively coupling the output of the tube to the grid of the 807 or HY69. The coupling coil L_c is wound in the opposite direction from the plate coil L_1 and the capacitance between the leads going to and from S_2 serves as neutralizing capacitance for the 6L6 tube.

The second 6L6 multiplier tunes over the frequency range from 21 to 30 Mc. and is normally used for excitation of the final amplifier on the 15 meter band, the 10 and 11 meter bands, and is further used for exciting the final stage as a frequency doubler on the 50-Mc. band.

The HY69 or 807 final stage receives its excitation from either the 6AG7 or the first or second 6L6 by selecting the proper switch position of S_2 . Five tank coils have been provided in the plate circuit of the final stage to permit front panel selection of operation on all the amateur bands previously listed. The coil which has been specified for the 10-meter band also tunes with capacitor C_1 at nearly full capacitance to the 15-meter band. Separate links on each of the tank coils are selected by a section on S_1 for coupling the energy into the output coaxial transmission line. Another function of switch S_1 is to short the coil which tunes to the 80-meter band when the transmitter is operating on any other band. In addition,

Figure 11.
REAR VIEW OF THE EXCITER.

The output circuit band switch and the associated tank circuits can be seen in the left front of the chassis. The coaxial output connector is on the extreme left of the rear drop of the chassis and the input connector for the v-f-o signal is just to the right of the output connector.

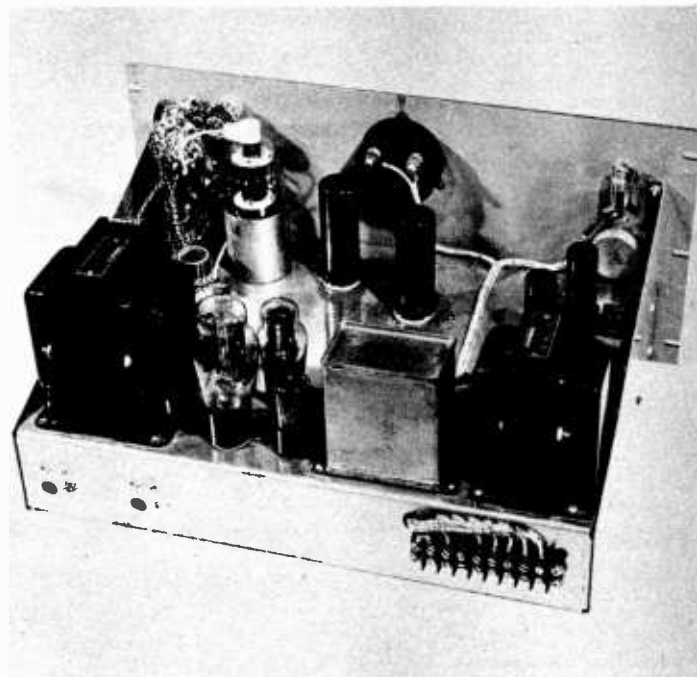

another section of this switch shorts the 40-meter coil when the unit is operating on any other band than 40. Some experimentation with the grounding of capacitors C_8 and C_9 may be required in order to obtain completely stable operation of the stage on all frequency ranges. Although an 807 or HY69 is shown as being used in the output stage, a 2E26 tube could be used with no change in the equipment other than the tube socket.

Power Supply A self-contained 400-volt, 150-ma. power supply and a 120-volt bias supply have been included within the equipment. Meter switching is used to measure the current drain of each of the tubes other than the crystal oscillator in the transmitter. Normal plate currents on the various tubes are as follows: 6AG7, from 5 ma. to 30 ma., dependent upon the amount of excitation required; first 6L6, 15 ma.; second 6L6, 25 ma.; HY69 or 807 final amplifier, 70 to 85 ma.

Potentiometer R₁ serves as an excitation control for the entire exciter by varying the screen voltage and hence the power output of the 6AG7 first stage. This control should be varied until the point of maximum power output from the final stage is reached and then the control should be increased slightly past this point to insure that adequate excitation is provided for all stages.

Two terminals on the connection strip on the rear of the chassis have been provided to control application of plate voltage to the transmitter. A plate voltage switch was not included on the front panel of the unit since it is intended to serve as an exciter in a high powered transmitter where plate voltage will be controlled by a set of contacts on the main power relay.

COIL TABLE
807/HY69 All-Band Exciter

- L₁—3.5 Mc.: 44 t. no. 22 closewound on XR-2 form. Output link 8 t. hookup wire on cold end of coil.
- L₂—7.0 Mc.: 26 t. no. 18 enam. closewound on XR-2 form. Output link 5 t. hookup wire on cold end.
- L₃—14 Mc.: 14 t. no. 18 enam. closewound on 3/4" polystyrene form. Output link 5 t. hookup wire on cold end.
- L₄—28 Mc.: 9 t. no. 14 enam. closewound on 3/4" polystyrene form. Output link 4 t. hookup wire on cold end.
- L₅—50 Mc.: 4 1/2 t. no. 14 enam. spaced to 3/4" on 3/4" polystyrene form. Output link 2 t. hookup wire on cold end.
- L₆—17 turns no. 18 enam. spaced to 3/4" on 1" XR-2 form.
- L₇—11 turns no. 18 enam. spaced to 3/8" on 1" XR-2 form.
- L₈—15 turns no. 18 enam. closewound on 3/4" polystyrene form inside coil form of L₁.
- L₉—7 turns no. 14 enam. spaced to 7/8" on 3/4" polystyrene form.

SIMPLE OPERATING-TABLE V-F-O UNIT

The convenient v.f.o. shown in Figures 14 and 15 is the result of considerable experimentation in an effort to develop a simple operating-table v.f.o. giving adequate frequency stability that could be home constructed. The output circuit of the unit covers the total frequency range from 3100 kc. to 4050 kc. in four discreet frequency ranges. The output power is approximately 0.5 watt over the entire frequency range.

Coupling to Transmitter The v-f-o unit is designed for placement on the operating table with a 52-ohm coaxial cable of RG-58/U running from the v.f.o. to the transmitter. At the transmitter the 52-ohm cable should be coupled into the first stage of the exciter unit. The center conductor of the coaxial cable may be coupled

Figure 12.
UNDERCHASSIS VIEW SHOWING PLACEMENT OF COMPONENTS.

From right to left the panel controls are: meter switch, excitation switch to grid of output stage, second 6L6 tuning capacitor, first 6L6 tuning capacitor, 6AG7 tuning capacitor, crystal/v.f.o. switch. The resistor board parallel to the panel holds the screen resistors and the meter resistors. The other resistor board holds the bias pack filter and the voltage divider on the h-v supply with the exception of R₁₁ which is mounted vertically from the chassis. The components associated with the keying circuit can be seen just to the left of R₁₁.

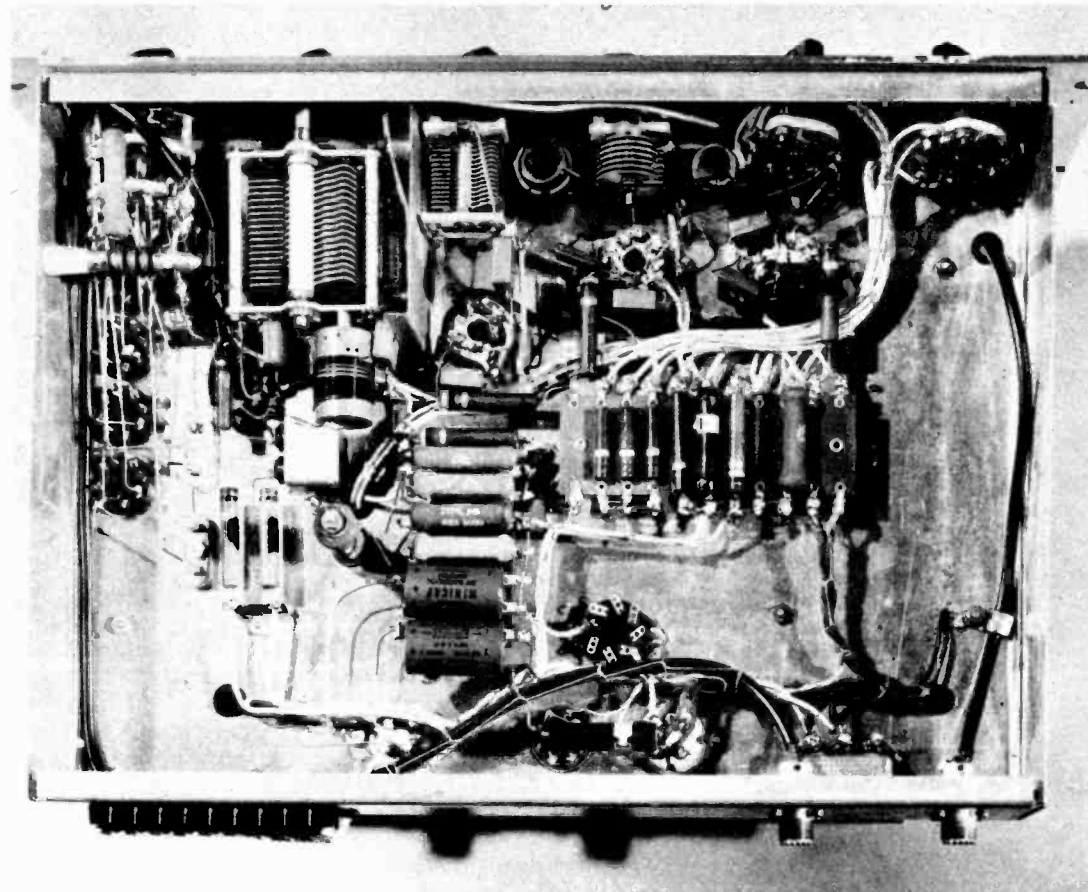
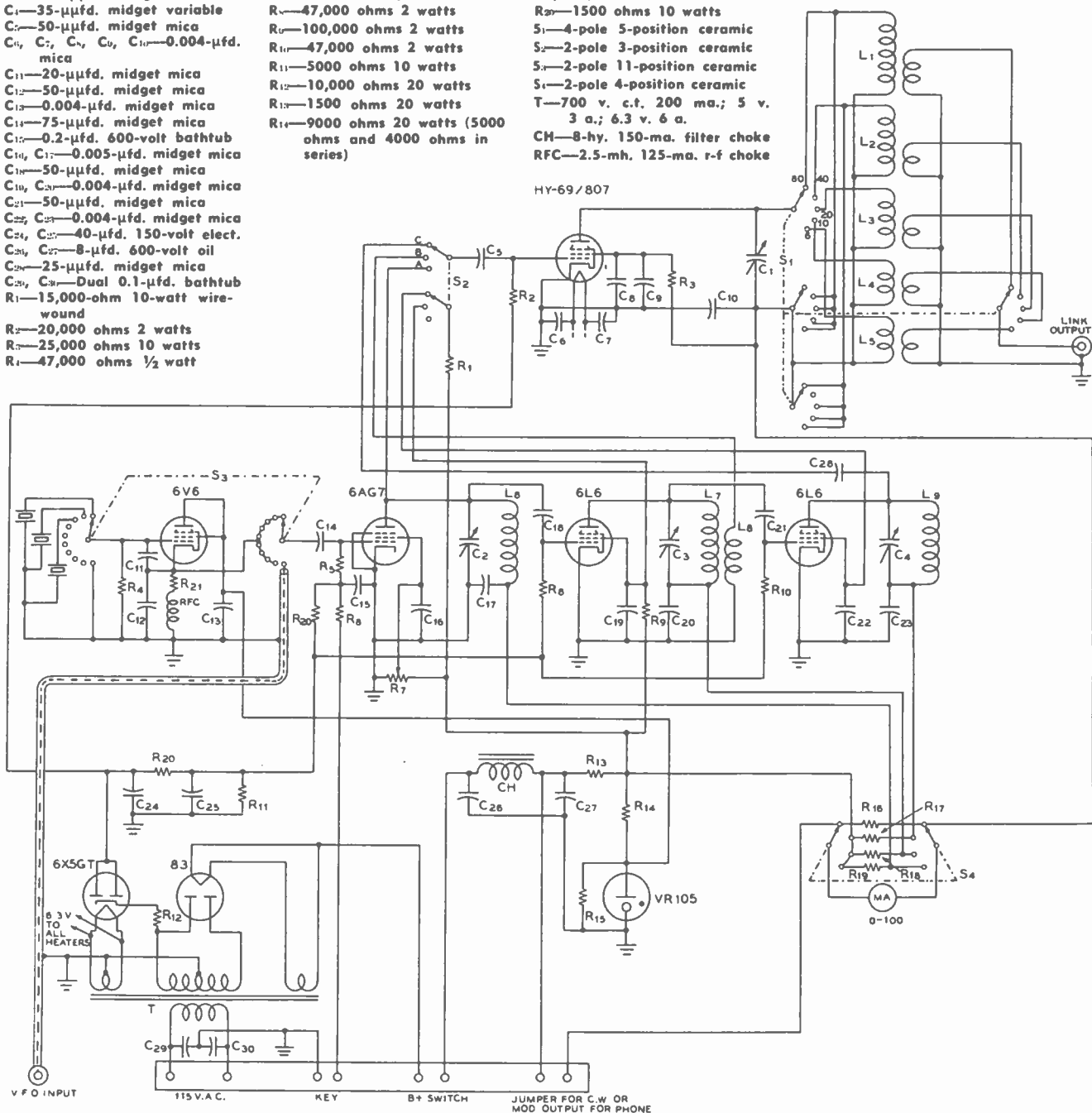

Figure 13.
CIRCUIT DIAGRAM OF THE BANDSWITCHING EXCITER UNIT.

- C₁—50- μ fd. midget variable
- C₂—365- μ fd. variable
- C₃—140- μ fd. midget variable
- C₄—35- μ fd. midget variable
- C₅—50- μ fd. midget mica
- C₆, C₇, C₈, C₉, C₁₀—0.004- μ fd. mica
- C₁₁—20- μ fd. midget mica
- C₁₂—50- μ fd. midget mica
- C₁₃—0.004- μ fd. midget mica
- C₁₄—75- μ fd. midget mica
- C₁₅—0.2- μ fd. 600-volt bathtub
- C₁₆, C₁₇—0.005- μ fd. midget mica
- C₁₈—50- μ fd. midget mica
- C₁₉, C₂₀—0.004- μ fd. midget mica
- C₂₁—50- μ fd. midget mica
- C₂₂, C₂₃—0.004- μ fd. midget mica
- C₂₄, C₂₅—40- μ fd. 150-volt elect.
- C₂₆, C₂₇—8- μ fd. 600-volt oil
- C₂₈—25- μ fd. midget mica
- C₂₉, C₃₀—Dual 0.1- μ fd. bathtub
- R₁—15,000-ohm 10-watt wire-wound
- R₂—20,000 ohms 2 watts
- R₃—25,000 ohms 10 watts
- R₄—47,000 ohms 1/2 watt

- R₅—47,000 ohms 1 watt
- R₆—20,000 ohms 1 watt
- R₇—50,000-ohm potentiometer
- R₈—47,000 ohms 2 watts
- R₉—100,000 ohms 2 watts
- R₁₀—47,000 ohms 2 watts
- R₁₁—5000 ohms 10 watts
- R₁₂—10,000 ohms 20 watts
- R₁₃—1500 ohms 20 watts
- R₁₄—9000 ohms 20 watts (5000 ohms and 4000 ohms in series)

- R₁₅—100,000 ohms 2 watts
- R₁₆—100 ohms 2 watts
- R₁₇, R₁₈, R₁₉—100 ohms 1 watt
- R₂₀—1500 ohms 10 watts
- S₁—4-pole 5-position ceramic
- S₂—2-pole 3-position ceramic
- S₃—2-pole 11-position ceramic
- S₄—2-pole 4-position ceramic
- T—700 v. c.f. 200 ma.; 5 v. 3 a.; 6.3 v. 6 a.
- CH—8-hy. 150-ma. filter choke
- RFC—2.5-mh. 125-ma. r-f choke



directly into the grid circuit of a 6L6, 6V6, 6AG7, or 7C5 tube. The output from the first tube in the transmitter will be small with this circuit, however, since only a small amount of exciting voltage will be applied to the grid. A better arrangement affording a much improved impedance match from the coaxial cable to the first tube is to operate this first stage as a grounded-grid amplifier in the manner shown in Figure 17. With this circuit arrangement the inner conductor of the coaxial cable is connected directly to the cathode of the first tube. With this grounded grid arrangement as shown no tendency toward oscillation will be experienced and improved output from the tube can be obtained either operating the

stage as an amplifier or as a frequency multiplier. Of course the v.f.o. may be coupled to the grid of the first tube by link coupling the coaxial line to a tuning circuit in the conventional manner. However, this system requires an additional tuning control and in addition a tendency toward oscillation may be encountered unless a well-shielded tube such as a 6AG7 or 2E26 is used in the first stage of the exciter.

Frequency Coverage On all frequency ranges the fundamental of the 6SK7 oscillator is on the 160-meter band. The 6AG7 tube operates as a broad band frequency doubler covering from 3100 to 4050 kc. On range 3,

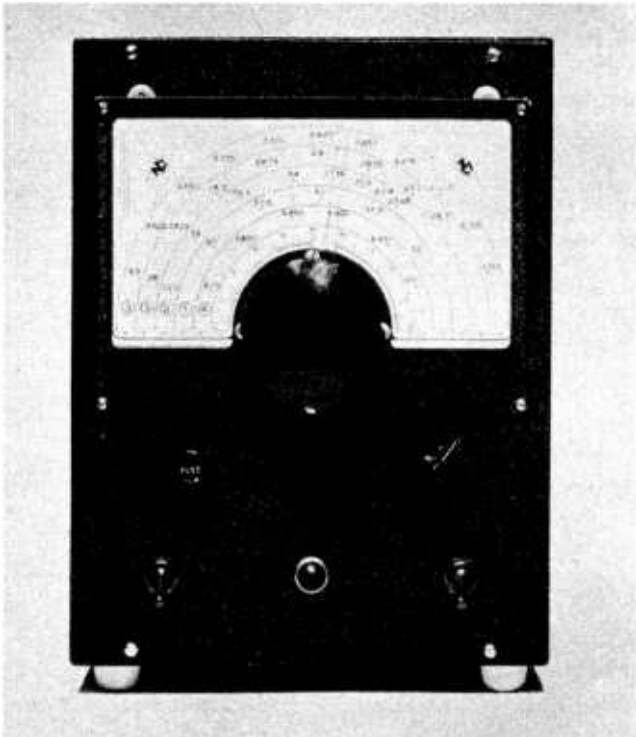

Figure 14.
FRONT VIEW OF THE OPERATING-TABLE V-F-O UNIT.

the fundamental frequency range of the unit, the oscillator hits 3500 kc. at 10 on the dial and 3750 kc. at 90. Thus the 10 meter band covers most of the dial, 20 covers about 40%, and the 40 meter band covers about 60%. Note from Figure 16 that there is no additional impedance connected to the tank circuit on this frequency range by S_1 . This has been done to obtain the highest degree of stability on this most commonly used range of the v.f.o. for c-w operation on these bands.

The balance of the 80 meter band is covered on range 4 by paralleling L_1 across L_2 . This additional coil L_1 is wound on a National XR50 slug-tuned coil form. Adjustment of the tuning slug will allow placement of the 3750 kc. point at about 10 on the dial and 4000 kc. at about 85.

The 11-meter band and the range above 52.5 Mc. on the 6-meter band are covered on range 2 by paralleling additional capacitance across the tank circuit of the 6SK7 oscillator. On this frequency range the v.f.o. covers from approximately 3250 kc. to 3500 kc.

Range 1 is used for the 50 to 52.8 Mc. portion of the 6 meter band by paralleling still more capacitance across the tank circuit than was used for range 2. With the value of capacitance shown the range is from approximately 3100 to 3300 kc., a frequency multiplication of 16 times being required to go from v-f-o output to the desired frequency in the 50 Mc. band.

Any of these frequency ranges may be dropped simply by eliminating the additional capacitors and the switch position. It was felt most advisable, however, in the design of the v.f.o. to incorporate additional ranges for the non-harmonically related amateur bands to allow the greatest degree of band-spread on each range. This is particularly important in the case of the 14,000 to 14,400 kc. range. Constructional information for all coils for the v.f.o. has been given in Figure 16.

Frequency Stability The outstanding problem in any variable-frequency oscillator is to obtain adequate frequency stability for the use of a crystal filter at the receiving position on the 28-Mc. band. This is usually the limiting factor in so far as frequency stability is concerned for amateur band work. Thus the frequency must be stable with respect to warm-up, ambient temperature variations, line voltage shift, and the presence of a strong r-f field in the vicinity of the v.f.o. Stability with respect to tube heating has been obtained by using very high C across the oscillator tank circuit. At 3500 kc. there is nearly 900 $\mu\text{mfd.}$ across the tank circuit. With this large value of tank capacitance tube heating causes substantially no effect on the oscillator stability after an initial warm-up period of approximately three minutes.

Temperature stability in the v-f-o unit has been obtained by using zero-coefficient ceramic capacitors for the majority of the tank capacitors. In addition both a fixed and an adjustable negative-coefficient compensating capacitor are used across the tank circuit to equalize for the positive temperature coefficient of the other components in the oscillator. An air padder capacitor has also been placed across the tank circuit to set the band edge and to reset the band edge when an adjustment in the amount of negative-coefficient capacitance has been made. As a further aid to temperature stability the

Figure 15.
INTERIOR VIEW OF THE SIMPLE V-F-O- UNIT.

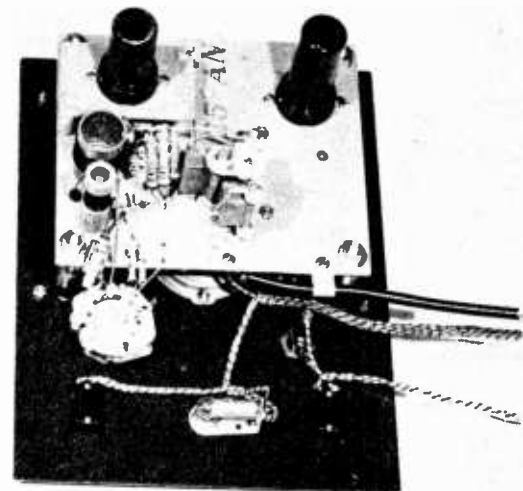
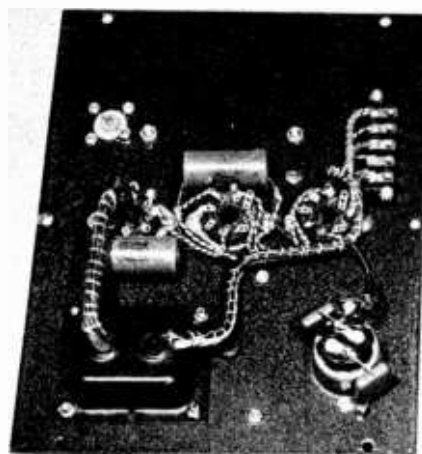

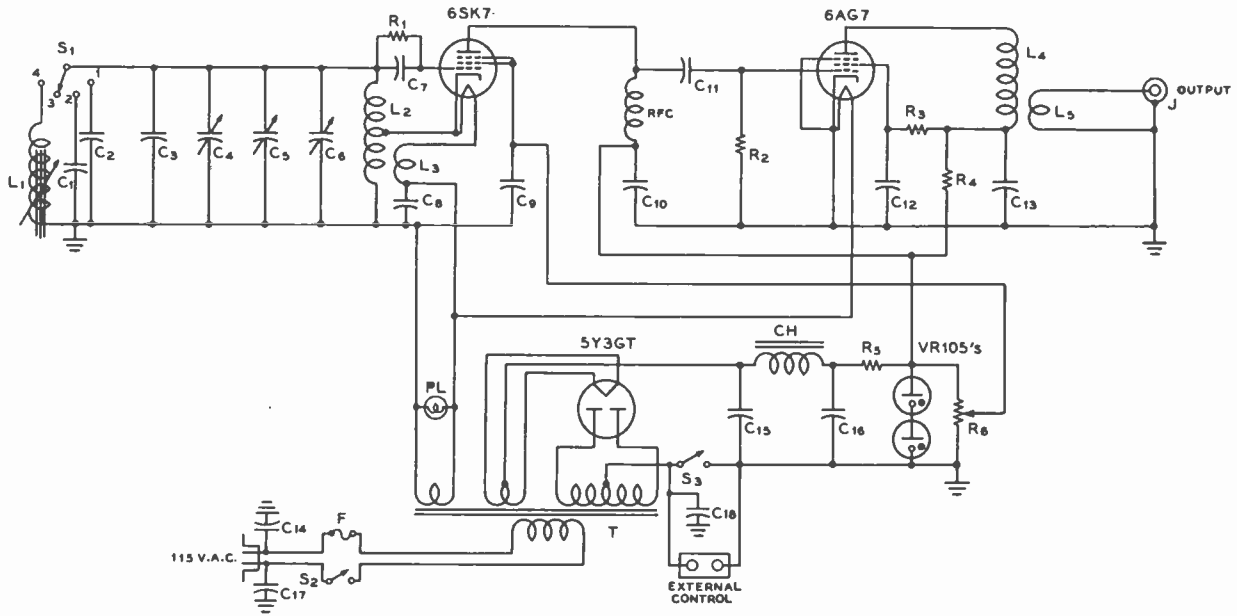

Figure 16.

SCHEMATIC DIAGRAM OF THE OPERATING-TABLE V-F-O UNIT.

- | | | | |
|--|---|---|--|
| <p>C₁—125-μfd. zero-coefficient ceramic</p> <p>C₂—250-μfd. zero-coefficient ceramic</p> <p>C₃—700-μfd. ceramic made up of three 200-μfd. zero coefficient, one 50-μfd. zero coefficient, and one 50-μfd. negative coeff., all in parallel.</p> <p>C₄—Main tuning capacitor, 150-μfd. midget variable, double bearing</p> <p>C₅—50-μfd. air padder capacitor</p> | <p>C₆—35-μfd. negative-coefficient ceramic trimmer capacitor</p> <p>C₇—100-μfd. midget ceramic</p> <p>C₈, C₉, C₁₀—0.003-μfd. midget mica</p> <p>C₁₁—0.0001-μfd. midget mica</p> <p>C₁₂, C₁₃, C₁₄—0.003-μfd. midget mica</p> <p>C₁₅, C₁₆—8-μfd. 450-volt elect.</p> <p>C₁₇, C₁₈—0.003-μfd. midget mica</p> | <p>R₁—100 ohms 2 watts</p> <p>R₂—2250 ohms 10 watts</p> <p>R₃—20,000 ohms 25 watts, slider-type divider</p> <p>R₄—1.0 megohm 1/2 watt</p> <p>R₅—100,000 ohms 1/2 watt</p> <p>R₆—22,000 ohms 2 watts</p> | <p>L₁—7 turns hookup wire around cold end of L₄</p> <p>T—650 v. c.t. 40 ma., 5 v. 2 a., 6.3 v. 2 amperes</p> <p>CH—13 hy. at 65 ma. choke</p> <p>S₁—V-f-o range switch, 1-pole 4-position 90° ceramic</p> <p>S₂—A-c line switch, toggle</p> <p>S₃—Local plate-voltage switch for checking v-f-o freq. in receiver, s.p.s.t. toggle</p> <p>RFC—2.5-mh. 125-ma. r-f choke</p> <p>PL—6.3-volt pilot lamp</p> |
|--|---|---|--|

components of the power supply which give off large amounts of heat have been placed on the outside of the housing.

Frequency variations resulting from line voltage variations have been minimized through the use of an electron coupled oscillator circuit and through the use of VR tubes across the plate voltage supply for the oscillator. The effect of external r-f fields has been minimized by completely shielding the oscillator unit, by using a coaxial output fitting, and by the use of by-pass capacitors across the a-c line voltage leads as they enter the housing through the male a-c cord receptacle.

Construction The v-f-o unit is housed in a 7" by 8" by 10" sheet-metal cabinet. In order to improve the mechanical stability of the assembly the thin sheet-metal front panel provided with the cabinet is replaced by a piece of 1/8" 24ST dural. In addition, the entire r-f unit of the v.f.o. is constructed on a piece of 1/8" dural 5 1/2" by 6 1/2". This dural sub-chassis is supported 2" behind the dural front panel by means of 1/4" flat-head brass bolts and spacers. The tube socket for the 6SK7 oscillator is supported 1" behind the dural sub-chassis by standoff pillars, the socket itself being mounted upon a piece of 1/8" dural 1 1/2" by 3".

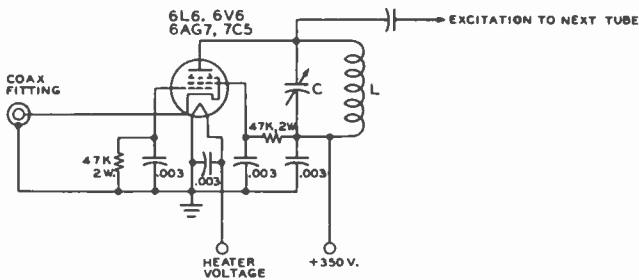

Figure 17.

SUGGESTED COUPLING CIRCUIT FROM V-F-O AT TRANSMITTER.

Although any of the tubes shown may be used, the 6AG7 tube is recommended since the suppressor in this tube may be grounded to reduce coupling between the output circuit and the input line. For greatest output the tank circuit C-L should be tuned to a frequency in the 3 to 4 Mc. range; however the stage may be used as a doubler with reduced output.

Figure 18.

FRONT VIEW OF THE SIX-BAND V-F-O UNIT.

The key jack is in the lower left-hand corner. Note that the dial shown on the v.f.o. is of an early type and has been superseded by a slide-rule type dial.



Figure 19.
TOP VIEW OF THE 15-WATT
V-F-O UNIT.

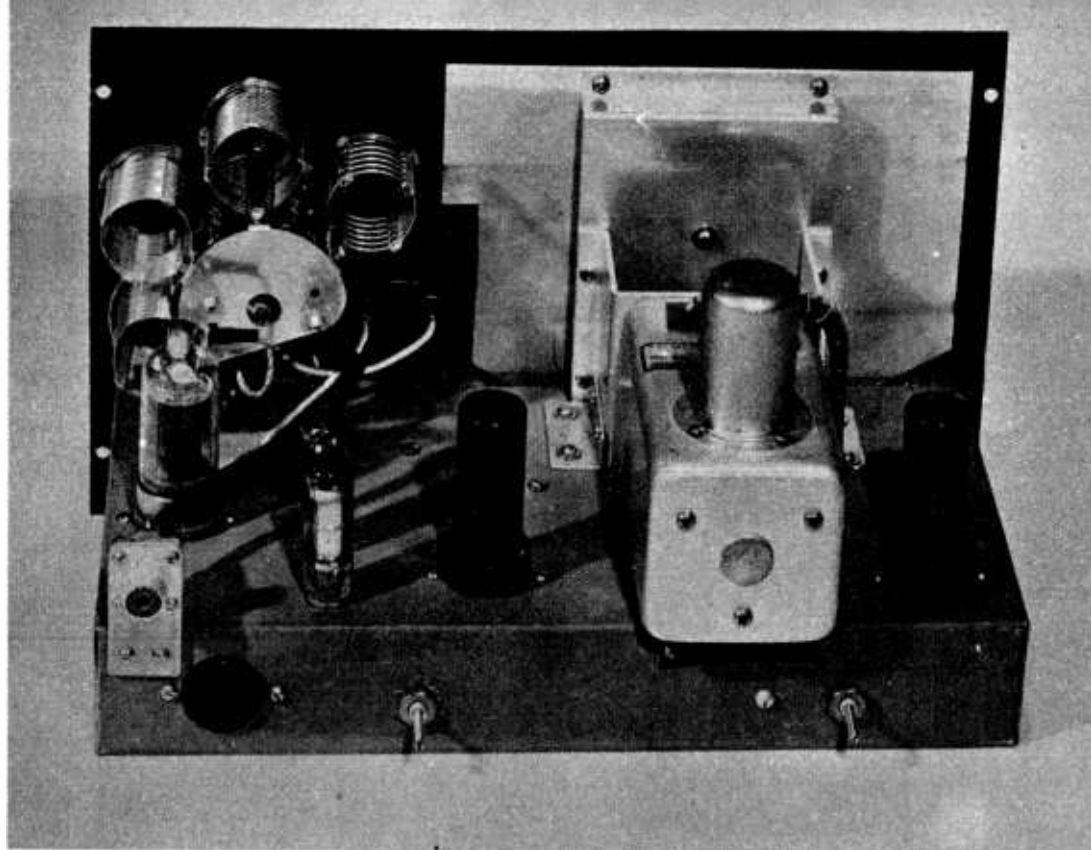

All the power supply components are mounted upon the sheet-metal back cover for the housing. The filter and by-pass capacitors are mounted inside and the tubes and bleeder resistors are mounted outside.

Care should be taken to insure that all components are mounted as rigidly as possible and that short, heavy interconnecting leads are used. Note that C_4 , the negative-coefficient trimmer capacitor, should be mounted in free air and not fastened to the chassis so that it will be affected by the air temperature inside the housing and not by the temperature of the chassis.

SIX BAND EXCITER UNIT USING COLLINS 70E-8 V.F.O.

The v-f-o exciter unit shown in Figures 18, 19, and 20 is capable of delivering 10 to 15 watts output on the 3.5, 7.0, 14.0, 21.0, 27.2 and 28 Mc. bands. A Collins 70E-8 permeability tuned variable-frequency oscillator is used in conjunction with two broadly tuned multiplier stages and a 2E26 transmitting beam tetrode in the output stage. The 2E26 output stage operates as an amplifier on the 3.5 Mc. and 14 Mc. bands and acts as a doubler on the 7, 21, 27 and 28 Mc. bands. Ample power output is available to drive a triode final amplifier to 200 to 400 watts input, and more than sufficient power is available to drive a pair of 4-125A's, 4-250A's or 813's to one kilowatt input.

The Circuit The Collins 70E-8 permeability-tuned oscillator unit is supplied with 210 volts which has been regulated by the two OB-2 voltage regulator tubes. This v-f-o unit, with fundamental on the 160-meter band, delivers an output signal on all the above bands having excellent stability characteristics and negligible drift. The particular Collins oscillator unit shown in the photographs is an early model. Present production units incorporate an improved slide rule type dial such as is shown in the photograph of Figure 22.

The 6AG7 amplifying doubler stage operates into a broadly resonant slug-tuned coil L_1 . When tuning up the exciter unit this coil is peaked at 3600 kc. The stage then will deliver substantially constant output over the range from 3200 to 4000 kc. For operation of the 2E26 over this frequency range or as a

doubler for operation on twice frequency, the switch SW_2 is placed in position two.

The second 6AG7 operates either as a tripler or a quadrupler. Hence its output circuit is tuned approximately to 10.8 Mc. or to 14.2 Mc. Trimmer capacitor C_1 has sufficient range so that L_2 may be tuned to either frequency. Although this tuned circuit tunes rather broadly, if maximum output from the 2E26 stage is required on frequencies above 14 Mc., this tuned circuit should be peaked to the operating frequency.

The 2E26 final stage operates with 400 to 500 volts on the plate and the plate current on the tube should be limited to 75 ma.

The Output Circuit The tank circuit of the 2E26 stage consists of a B&W BTEL 5-band turret from which one coil has been removed to make room on the panel for the Marion 0-100 ma. hermetically sealed 2-inch meter. The regular coils are used for the 80, 40 and 20 meter bands. The 10-meter coil is removed from the turret, and one turn is then removed from the 15-meter coil. This latter coil is then used for the 10 meter, 11 meter and 15 meter bands. It was found necessary to place capacitor C_3 in series with the lead from tuning capacitor C_2 to the coil turret to avoid damaging the meter in the event of flashover of C_2 . The addition of this series capacitor had no noticeable effect on the output of the exciter. A receptacle for RG-58/U coaxial cable has been placed on the rear of the chassis. At the transmitter the coaxial cable should be link coupled to the grid circuit of the stage being driven by the exciter.

Control Circuit SW_1 is the off-tune-operate switch. In the tune position a high value of resistance is placed in series with the 300-volt supply to the 6AG7's and the screen of the 2E26. With the switch in this position the unit delivers sufficient signal so that it may be heard on the 28-Mc. band. Fixed bias of 50 volts is used on the grid of the 6AG7 second doubler and the 2E26 final stage. This permits cathode keying of the first 6AG7 stage and allows the oscillator to be run continuously for greatest stability. If a very short shielded lead is run from the oscillator unit to the grid of the first 6AG7, the signal in the receiver from the oscillator with the key up is sufficiently low so that it will not cause trouble.

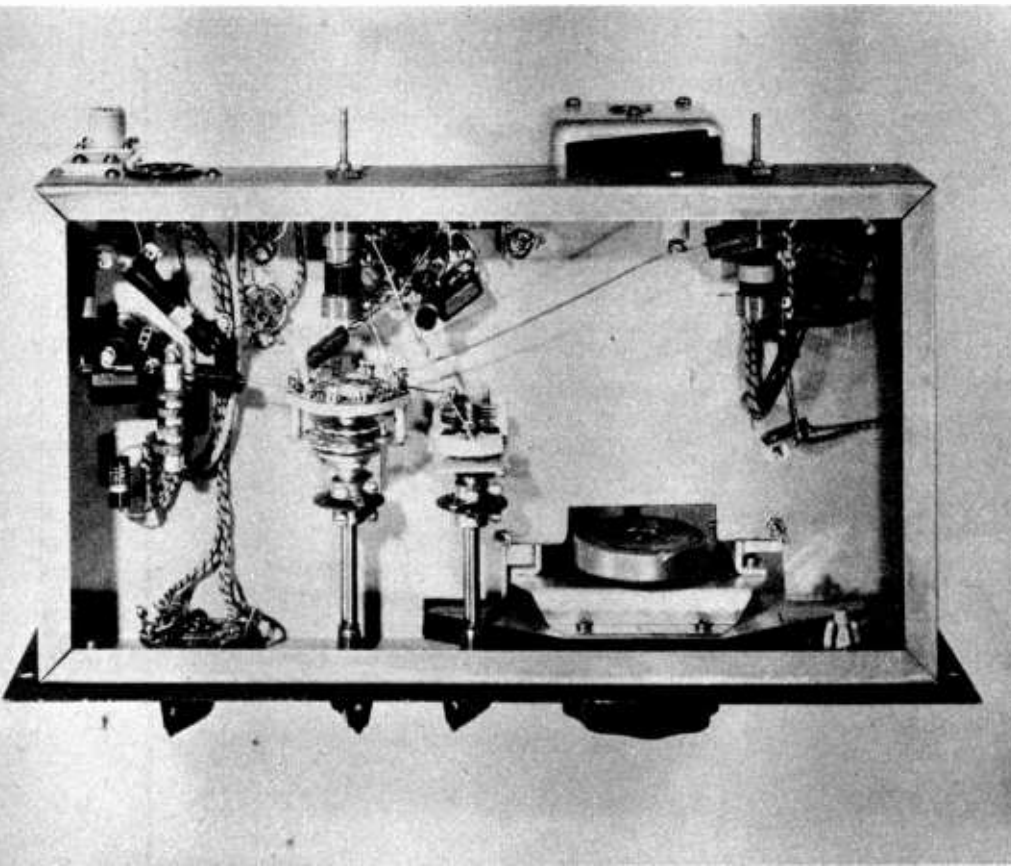

Figure 20.
UNDERCHASSIS VIEW OF THE
EXCITER UNIT.

Note that C_1 and SW_1 have been mounted in the center of the chassis to shorten the leads to the second 6AG7 stage.

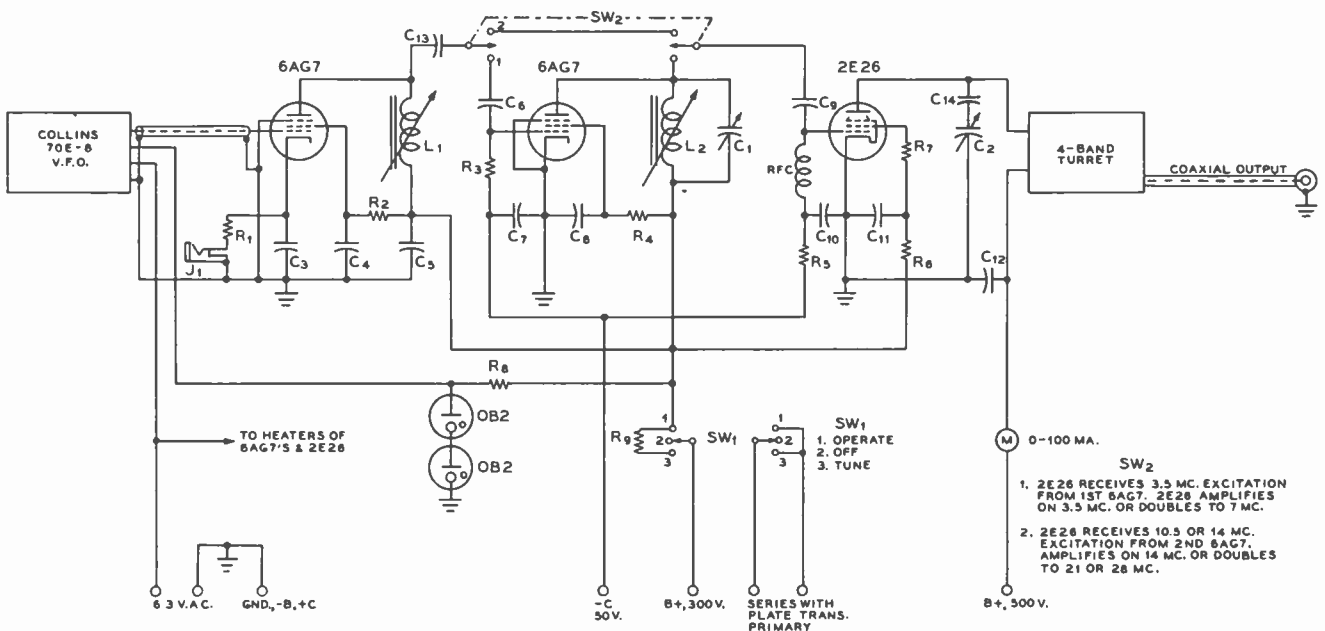

Figure 21.

SCHEMATIC DIAGRAM OF THE SIX-BAND V-F-O UNIT.

- C_1 —25- μ fd. APC capacitor
- C_2 —50- μ fd. midget variable
- C_3, C_4, C_5 —0.003- μ fd. midget mica
- C_6 —50- μ fd. midget mica
- C_7, C_8 —0.003- μ fd. midget mica
- C_9 —50- μ fd. midget mica
- C_{10}, C_{11}, C_{12} —0.003- μ fd. mica

- C_{13} —50- μ fd. midget mica
- C_{14} —0.003- μ fd. midget mica
- R_1 —1000 ohms, 2 watts
- R_2 —47K ohms, 2 watts
- R_3 —100K ohms, 1/2 watt
- R_4 —39K ohms, 2 watts
- R_5 —22K ohms, 2 watts
- R_6 —10,000 ohms, 10 watts

- R_7 —47 ohms, 2 watts
- R_8 —10,000 ohms, 10 watts
- R_9 —47K ohms, 2 watts
- J_1 —Key jack
- M —0-100 d-c milliammeter
- SW_1 —2-pole 3-pos. meter sw.
- SW_2 —D.p.d.t. ceramic switch
- L_1 —XR-50 form with one layer

- close-wound and 22 turns on second layer no. 30 enam. Scotch tape between layers.
- L_2 —XR-50 form, 19 t. no. 24 enam.
- Output Turret—Modify per text
- RFC—2.5-mh. 125-ma. r-f choke



Figure 22.

FRONT VIEW OF THE COLLINS VERSION OF THE 80-METER V.F.O.

This illustration also shows the new type dial assembly for the 70E-8 v-f-o unit as used in the six-band v-f-o unit also described in this chapter.

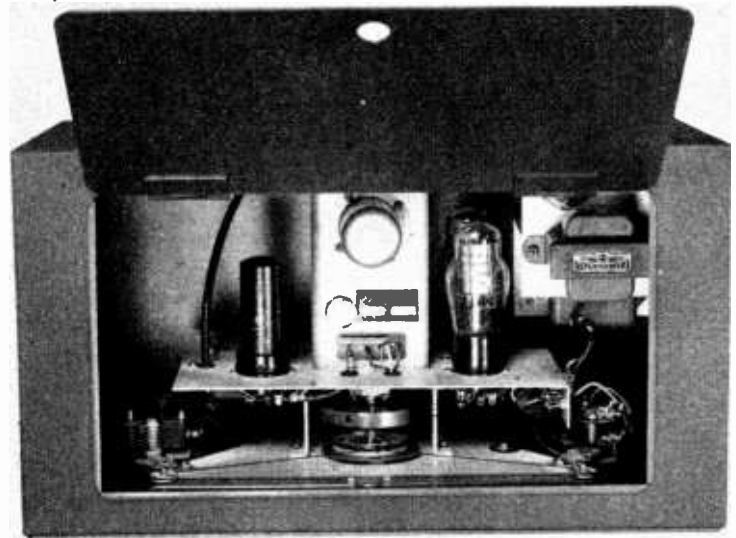

Figure 23.

LOOKING DOWN INSIDE THE HOUSING FOR THE 80-METER V.F.O.

The 6AG7 buffer-multiplier is mounted to the right of the oscillator unit and the two VR tubes are mounted on the other side of the p.t.o.

3.5 MC. V.F.O. USING COLLINS 70E-8 PTO

Figure 24 shows the circuit of a simple exciter for output on the 80-meter band using a Collins 70E-8 permeability-tuned oscillator as the v.f.o. The unit uses a single 6AG7 tube as a buffer-doubler stage with its plate circuit tuned to twice the exciter frequency as obtained from the oscillator unit. Approximately 0.2 watts is obtained from the output tube over the frequency range from 3.2 to 4.0 Mc. This amount of output is represented by approximately 80 volts r.m.s. across a 40,000-ohm resistor at the end of a 5-foot length of coaxial cable connected to the output of the 6AG7. This amount of energy is adequate to excite the crystal stage of a transmitter in place of the crystal or, if desired, an 807 may be excited as a doubler or as an amplifier. A version of this exciter unit as manu-

factured by the Collins Radio Co. and known as the no. 310-C2 is shown in Figures 22 and 23.

It is important that a coaxial line be used to couple the output of the 6AG7 to the grid circuit of the succeeding amplifier if the back wave which is present when the key is up is to be minimized. Also, this feed line should be as short as possible in order to provide the greatest amount of voltage at the grid of the succeeding amplifier. A length of five feet has proven to be quite satisfactory, although the use of a length even less than this will provide greater excitation to the following stage.

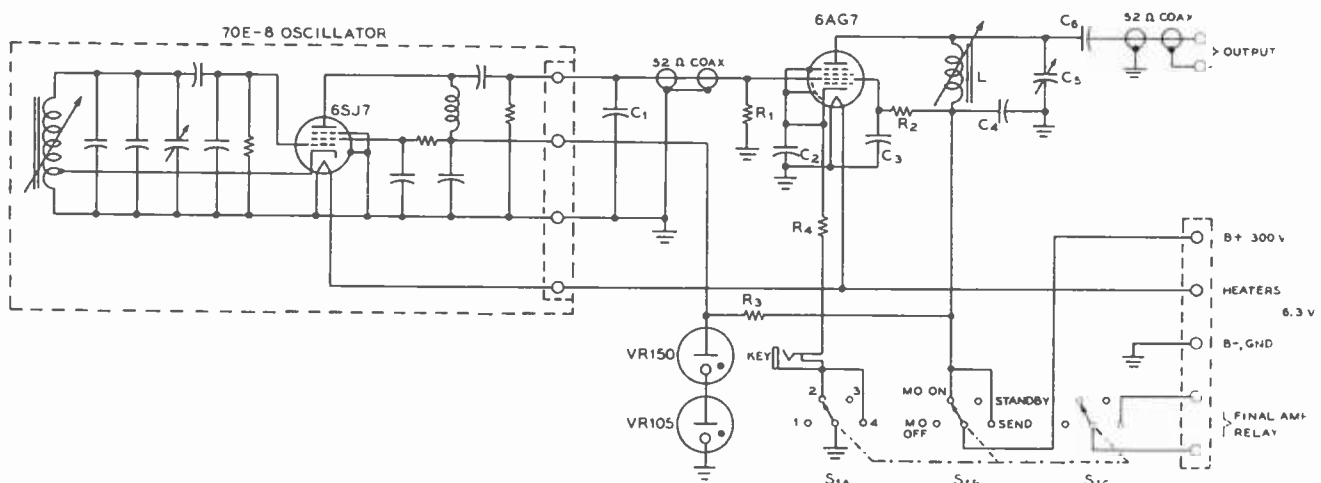

Figure 24.

SCHMATIC DIAGRAM OF THE 80-METER V.F.O.

- C₁—50- μ fd. midget mica
- C₂, C₃, C₄—0.01- μ fd. 600-volt tubular
- C₅—100- μ fd. midget variable

- C₆—150- μ fd. midget mica
- R₁—22,000 ohms 1/2 watt
- R₂—47,000 ohms 1/2 watt
- R₃—2200 ohms 1 watt

- R₄—1000 ohms 1/2 watt
- L—15-microhenry coil; 34 f. no. 24 enam. on 3/4" form, or 36 f. no. 26 enam. on XR-

- 50 slug-tuned form
- S₁—3-pole 4-position water switch

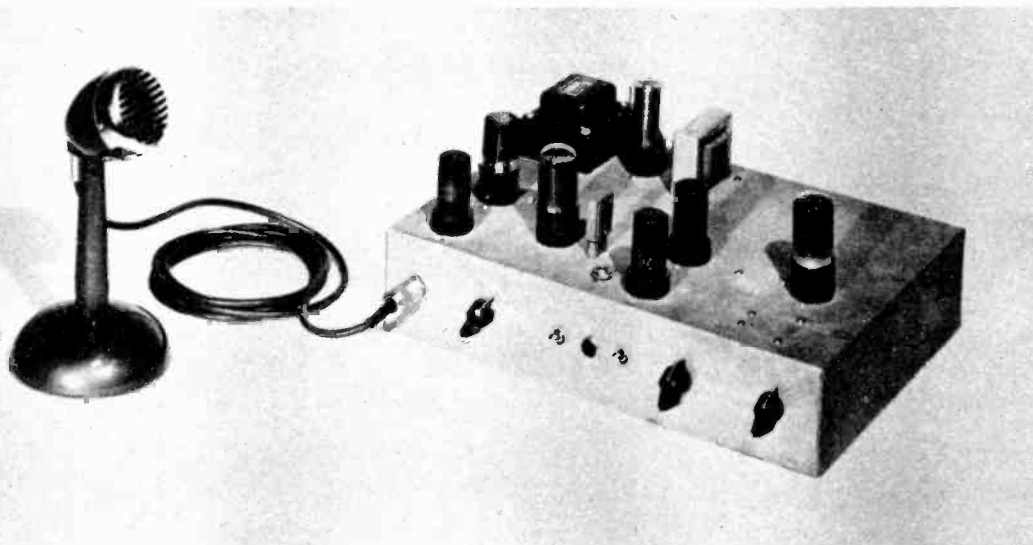

Figure 25.
OVERALL VIEW OF THE
NARROW-BAND FM
EXCITER UNIT.

In certain cases when the cable is coupled directly into the crystal socket of a crystal oscillator stage the crystal oscillator tube may oscillate as a t.p.t.g. oscillator. By inserting a small capacitor of 10 to 20 $\mu\text{fd.}$ in series with the lead from the center conductor of the coaxial cable to the crystal socket most of these cases of oscillation can be cured. The r-f output of the exciter will be reduced somewhat but it will be ample to excite all of the usual crystal oscillator stages.

Inspection of the photograph will show that the buffer-doubler assembly is mounted on an aluminum plate which mounts behind the oscillator dial and the oscillator housing. The insertion of this mounting plate into the assembly necessitates loosening the dial from the v-f-o unit. After the unit has been reassembled with the mounting plate in place the recalibration can be reset by checking the oscillator against WWV on 15 Mc. To recalibrate the oscillator it is simply necessary to tune a communications receiver to 15 Mc., set the 70E-8 dial to 15 Mc., and then to reach in between the panel and the mounting plate and adjust the oscillator tuning shaft by means

of the flexible coupler until zero beat between the output of the oscillator and WWV is obtained. After accurate recalibration has been obtained the flexible coupler should be tightened.

The exciter unit is keyed in the cathode circuit of the buffer stage. The keying of the unit with the component values shown in Figure 24 has proven to be quite satisfactory although softer keying can be obtained by inserting a 2.5 millihenry r-f choke in series with the 1000-ohm resistor in the cathode of the 6AG7.

NARROW BAND FM EXCITER UNIT

Difficulty has been encountered with several types of narrow band FM exciter units as the result of the fact that tuning of one or more of the circuits in the exciter is somewhat critical for best operation. In some cases there is only a very narrow range of tuning which will give adequate deviation without distortion from the exciter unit. The simple exciter unit shown in Figures 25 and 26 and diagrammed in Figure

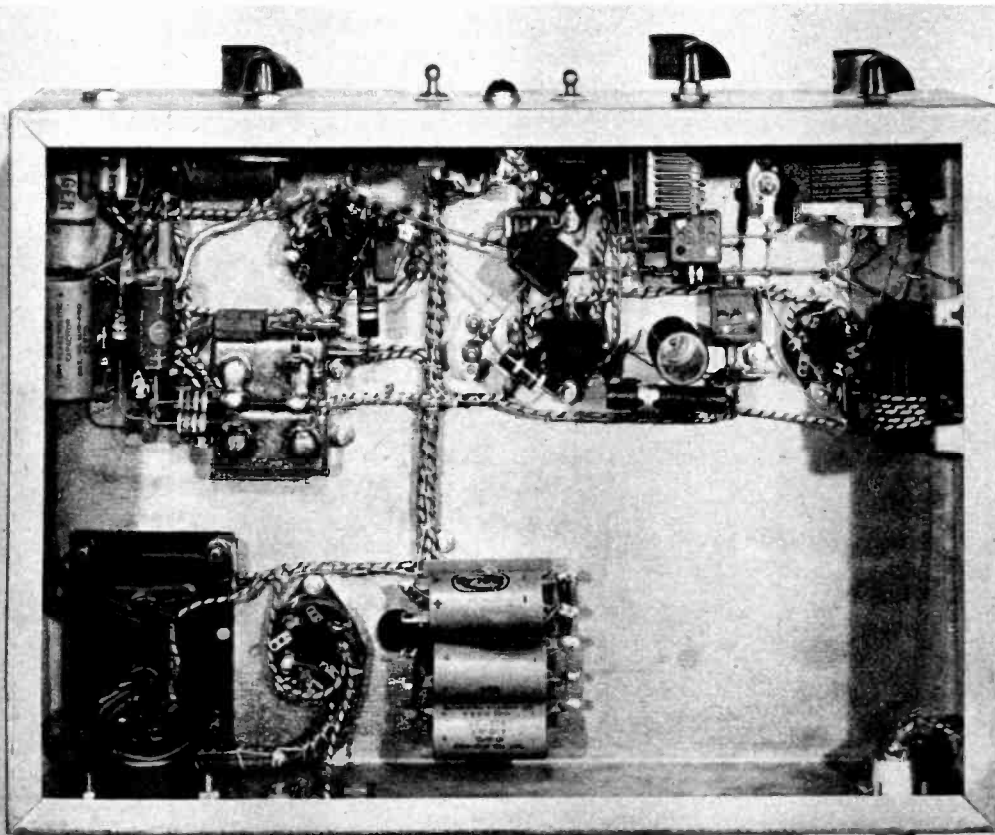

Figure 26.
UNDERCHASSIS VIEW OF THE
NBFM EXCITER UNIT.

As can be seen from the photograph, a somewhat smaller chassis could have been used for construction of the unit.

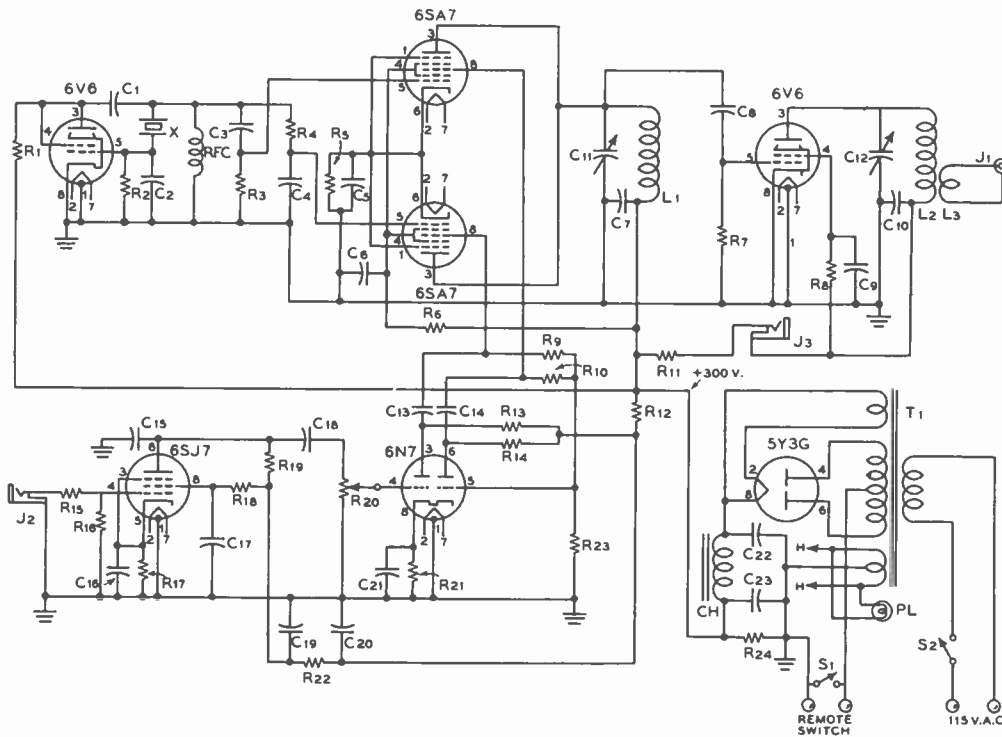

Figure 27.

SCHEMATIC DIAGRAM OF THE FM EXCITER UNIT.

- | | | | |
|--|---|--|--|
| <p>C₁—0.002-μfd. midget mica
 C₂—50-μfd. midget mica
 C₃, C₄—0.0001-μfd. midget mica
 C₅, C₆, C₇, C₈, C₉, C₁₀—0.002-μfd. midget mica
 C₁₁—140-μfd. midget variable
 C₁₂—100-μfd. midget variable
 C₁₃, C₁₄—0.05-μfd. bathtubs
 C₁₅—0.0005-μfd midget mica
 C₁₆—25-μfd. 25-volt elect.
 C₁₇—0.25-μfd. 400-volt tubular
 C₁₈—0.003-μfd. midget mica
 C₁₉, C₂₀—8-μfd. 450-volt elect.</p> | <p>C₂₁—25-μfd. 25-volt elect.
 C₂₂, C₂₃—10-μfd. 450-volt elect.
 R₁—22,000 ohms 2 watts
 R₂—47,000 ohms 1/2 watt
 R₃, R₄—470 ohms 2 watts
 R₅—100 ohms 2 watts
 R₆—10,000 ohms 10 watts
 R₇—100,000 ohms 2 watts
 R₈—47,000 ohms 2 watts
 R₉, R₁₀—220,000 ohms 1/2 watt
 R₁₁—100 ohms 2 watts
 R₁₂—4700 ohms 2 watts
 R₁₃, R₁₄—47,000 ohms 2 watts</p> | <p>R₁₅—47,000 ohms 1/2 watt
 R₁₆—470,000 ohms 1/2 watt
 R₁₇—1000 ohms 1/2 watt
 R₁₈—1.0 megohm 1/2 watt
 R₁₉—220,000 ohms 1/2 watt
 R₂₀—500,000-ohm potentiometer
 R₂₁—1800 ohms 2 watts
 R₂₂—22,000 ohms 2 watts
 R₂₃—100,000 ohms 1/2 watt
 R₂₄—100,000 ohms 1/2 watt
 X—Approx. 3.65 Mc. for 10-meter FM, 3.4 Mc. for 11 meters, and 3.3 Mc. for 6-meter FM</p> | <p>RFC—2.5-mh. 125-ma. r-f choke
 L₁—42 turns no. 24 enam. close-wound on 3/4" dia. form
 L₂—30 turns no. 20 enam. close-wound on 3/4" bakelite tube
 L₃—5-turn link around cold end of L₂
 T₁—600 v. c.t. 55 ma., 5 v. 2 a., 6.3 v. 2.7 amperes
 CH—13 henrys at 65 ma.
 S₁, S₂—S.p.s.t. toggle switches</p> |
|--|---|--|--|

27 is very simple to tune since there are no critical adjustments. It is simply necessary to plug a crystal whose harmonic hits the desired band of operation into the unit and tune C₁₁ and C₁₂ to resonance. The circuit tuned by capacitor C₁₁ is resonated at the operating frequency of the crystal and the 6V6 stage is operated as a doubler, hence is tuned to the second harmonic. Crystals in the vicinity of 2200 kc. or 3300 kc. are used for FM in the 50-Mc. band, and crystals in the vicinity of 3650 kc. are used for FM in the 29-Mc. band. The crystal frequency should be approximately 3400 kc. for operation in the 11-meter FM band.

The Circuit The operation of the circuit used has been discussed in some detail in Chapter 8. Suffice to say that C₃-R₃ and C₇-R₇ serve as a phase splitting network to excite the grids of the two 6SA7 tubes from 90 to 135 degrees out of phase. The 6N7 phase inverter in the speech amplifier supplies out of phase audio voltage to the signal grids of the two 6SA7 tubes. The phase of the output signal is alternately advanced or retarded as the audio signal applied to the 6SA7's reverses in polarity. The 6V6 stage merely acts as a multiplying amplifier. The two-stage speech amplifier is quite simple

in design and has a falling characteristic on frequencies above about 1000 cycles to compensate for the rising audio frequency characteristic of the phase-modulation circuit. The output of the 6V6 multiplier stage is fed to a coaxial cable and should be coupled to one of the multiplier stages in the transmitter. The unit is constructed on a chassis which is considerably larger than necessary. A chassis of approximately one-half the overall dimensions could be used and still leave ample room for all components. In fact, if each tube is replaced by its miniature type counterpart, the entire unit could be placed on

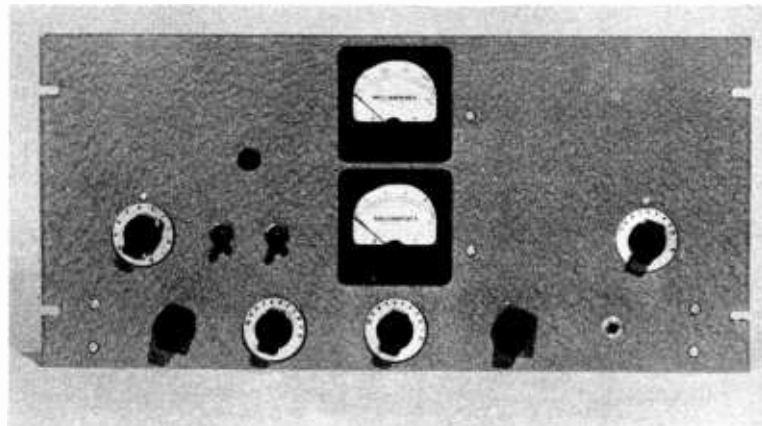

Figure 28.
FRONT-PANEL VIEW OF THE HK-57 EXCITER-TRANSMITTER.

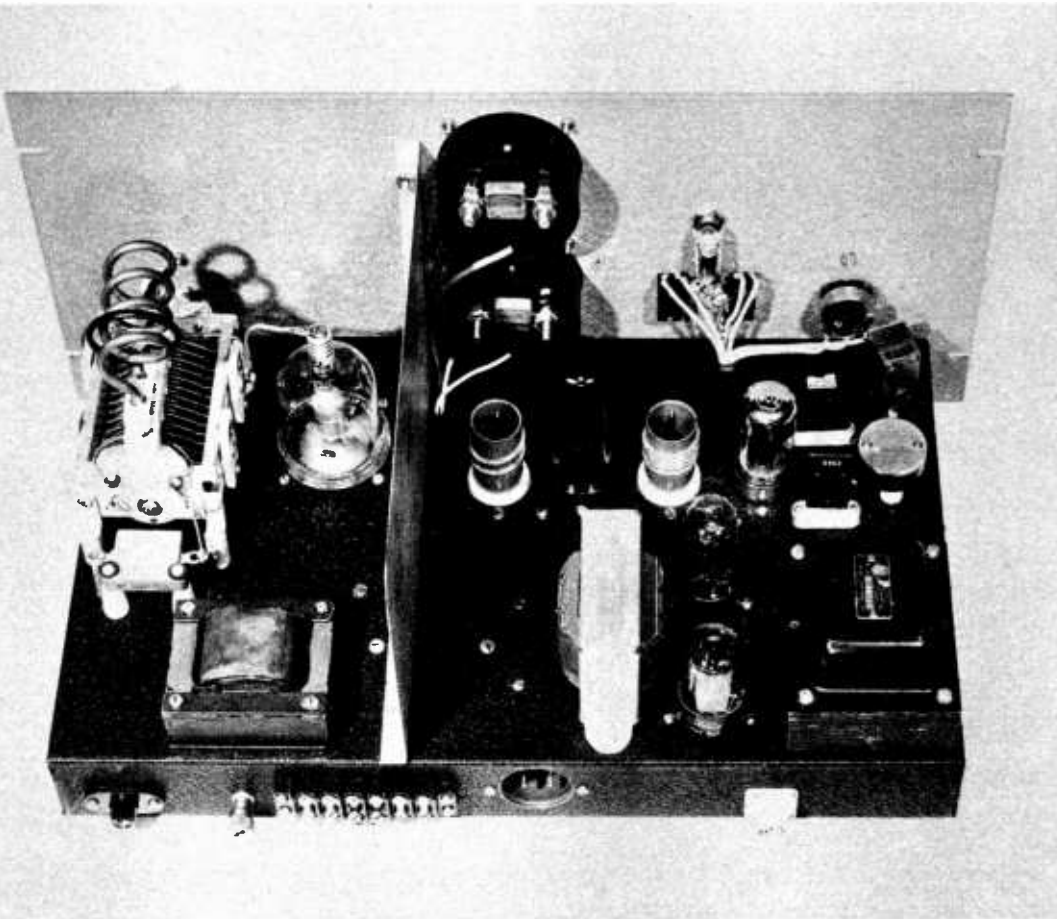

Figure 29.
REAR VIEW OF THE 150-
WATT EXCITER-TRANSMIT-
TER.

The coils for 50-Mc. operation are in place in the transmitter. The vertical shield just to the left of the meters serves both as a shield and as a chassis-supporting brace.

a chassis approximately 4 x 8 x 3 inches deep. If this substitution were to be made, 6AQ5 tubes would be used in place of the 6V6's, type 6BE6 would be used in place of the 6SA7's, 6AU6 would be used in place of the 6SJ7, and a 6J6 would be substituted for the 6N7. Such a unit might fit in very well for use as the first few stages of an exciter for a mobile FM transmitter. In this case a vibrapack would probably be used for power supply. If a miniature tube version were to be used for a-c operation, the 5Y3-GT tube could be replaced by a 6X4, and the heater of the 6X4 lighted from the 6.3 volt a-c line.

150 WATT ALL-BAND EXCITER TRANSMITTER

The unit shown in Figures 28, 29, and 30 has been designed to act as an exciter for a one-kilowatt final amplifier using triode tubes. Tests have shown that it is capable of delivering on the 50-Mc. band the maximum rated grid current of 200 ma. at rated bias for AM phone operation to the push-pull 250TH amplifier shown in Chapter 22. A still greater reserve of excitation power is available on the lower frequency bands down through 3.5 Mc. These tests were made with 1250 volts at 150 ma. on the HK57 final amplifier stage.

Since the low-voltage power supply and the bias pack for the unit are included on the chassis it is only necessary to supply an external 1250 volt, 150 ma. power supply to obtain a transmitter which is capable of 200 watts input on all amateur bands from 3.5 Mc. through 54 Mc. An internal keying circuit has been provided for c-w use. If amplitude-modulated phone is desired an external 100-watt modulator may be connected in series with the positive high voltage terminal which feeds the HK57 tube.

The Circuit A type 7C5 beam tetrode is used as a Colpitts hot-cathode crystal oscillator with plug-in coils in its plate circuit. The plate circuit of this stage may be tuned to the fundamental of the crystal frequency or to the

COIL TABLE
HK-57 Exciter/Transmitter

Grid coils	All grid coils wound on 1" diameter forms
3.5 Mc.	28 turns no. 20 enam. closewound
7.0 Mc.	14 turns no. 20 enam. spaced to 1 inch
14 and 21 Mc.	11 turns no. 20 enam. spaced to 5/8 inch
28 Mc.	5 turns no. 14 bare spaced to 3/4 inch
50 Mc.	2 1/8 turns no. 14 bare spaced to 3/4 inch
Plate coils	
3.5 Mc.	23 turns no. 14 enam. 1 7/8" dia. form closewound, link 5 turns no. 14 closewound at cold end.
7.0 Mc.	14 turns no. 14 enam. 1 7/8" dia. form spaced to 2 inches, link 5 turns closewound at cold end.
14 Mc.	8 turns no. 12 enam. 1 7/8" dia. form spaced to 1 1/2 inches, link 3 turns no. 14 at cold end.
21 and 28 Mc.	7 turns 3/16" copper tubing 1 1/4" inside diameter spaced to 2 1/4 inches at top. Link 2 turns no. 12 enam. wound outside and spaced 1/4" from plate coil. Link coil covered with high-voltage spaghetti.
50 Mc.	4 turns 3/16" copper tubing 1" inside diameter spaced to 2 1/4 inches at top. Link 1 turn no. 12 enam. wound outside and spaced 1/4" from plate coil. Link coil covered with high-voltage spaghetti.

See Buyer's Guide for suppliers of coil forms.

Figure 30.
UNDERCHASSIS VIEW OF THE
TRANSMITTER.

Note the grounding strap which has been run completely around the socket of the HK-57. Separate by-pass capacitors have been run to each filament, screen, and suppressor lead of the final amplifier tube.

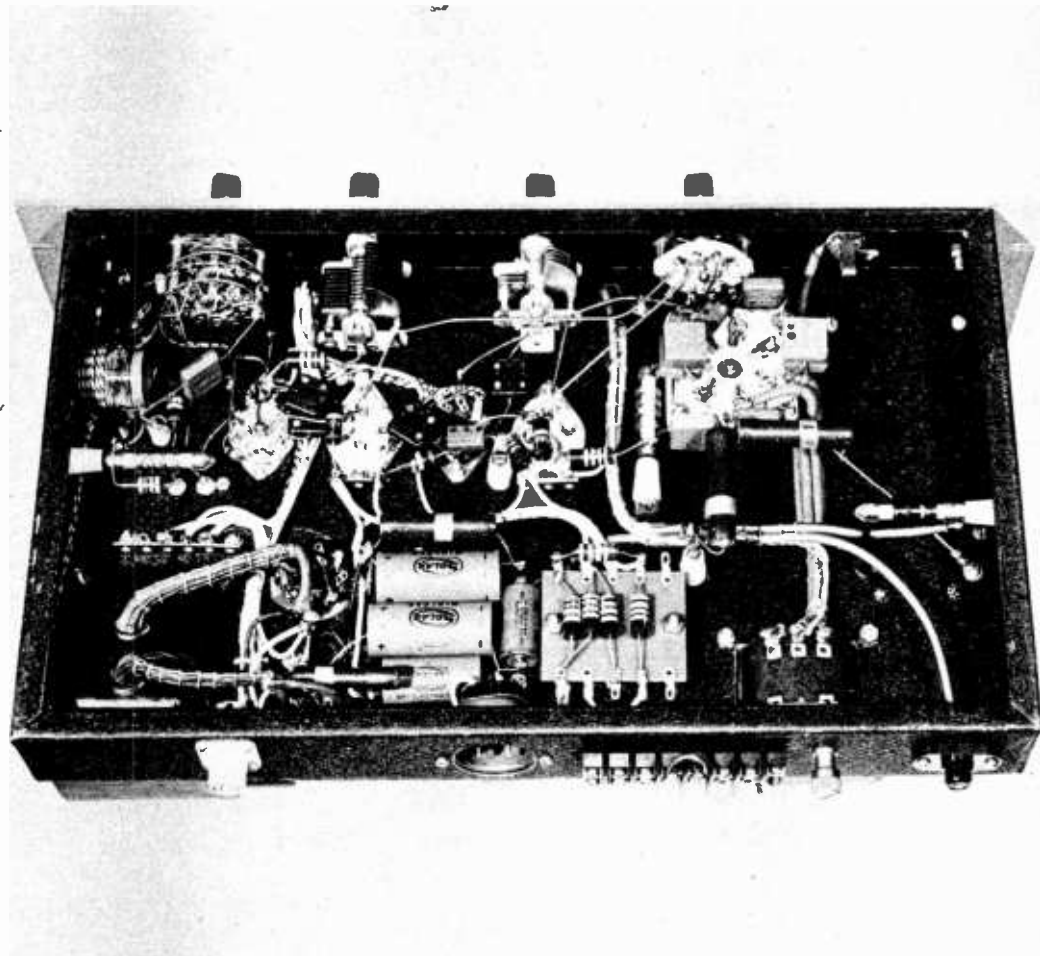

second, third or fourth harmonic of the crystal frequency. The screen voltage on the 7C5 stage is varied by means of potentiometer R₂ to serve as an excitation control for the grid of the final amplifier stage. Note that resistors R₂ and R₁ have been placed in series with this potentiometer so that the screen voltage may not be reduced below the point where the crystal will stop oscillating or raised to the point where excessive crystal current will flow. Positions for five standard crystals have been provided inside the equipment. In the sixth position of S₂ the grid of the 7C5 is grounded and excitation from an external v.f.o. may be fed to the cathode of the 7C5. The output circuit of this stage may then be tuned to the excitation frequency from the v.f.o. or to the second, third or fourth harmonic of the exciting frequency.

The 6L6 multiplier stage also uses plug-in coils in its plate circuit. Actually the same coils are used either in the plate of the 7C5 or in the plate of the 6L6, depending upon the band of operation desired and the frequency of the crystal being used. This stage is normally used on the 28 and 50 Mc. bands and may be used if desired when operating on other bands with a low frequency crystal. Fixed minimum bias is used on the grid of the 6L6 stage so that plate current on this tube will be cut off when S₁ is in the position where excitation is being delivered directly from the 7C5 to the grid of the HK57.

The HK57 stage is used as an amplifier on all bands through 54 Mc. Provision has been made for suppressor-grid keying of this tube. The full output of the bias pack which uses a

6X5GT tube is applied to the suppressor grid of the HK57 when the key is up. For AM phone operation the external key positions on the terminal strip on the rear of the unit are shorted. Two by-pass capacitors are used on both the screen grid and the suppressor grid of the HK57 tube to obtain minimum inductance in these by-pass leads. Plug-in coils wound on Millen no. 44001 coil forms are used in the plate circuit of the HK57 tube on all bands. The coil table gives data for the winding of these inductors. The by-pass capacitors shown across the grid and plate milliammeters were found to be necessary in operation of the unit. Note that leads from both sides of the plate tuning capacitor are run to the lugs on the tank coil socket. This must be done to reduce the inductance of the tank circuit leads so that the 50-Mc. band coil will hit the band properly with most of the inductance in the coil and not in the leads from the tuning capacitor.

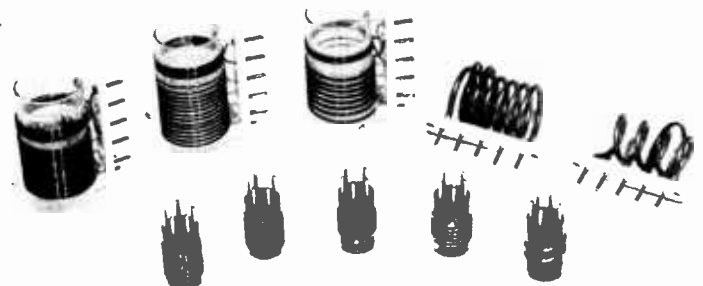

Figure 31.
COMPLETE COIL COMPLEMENT FOR THE HK-57
TRANSMITTER.

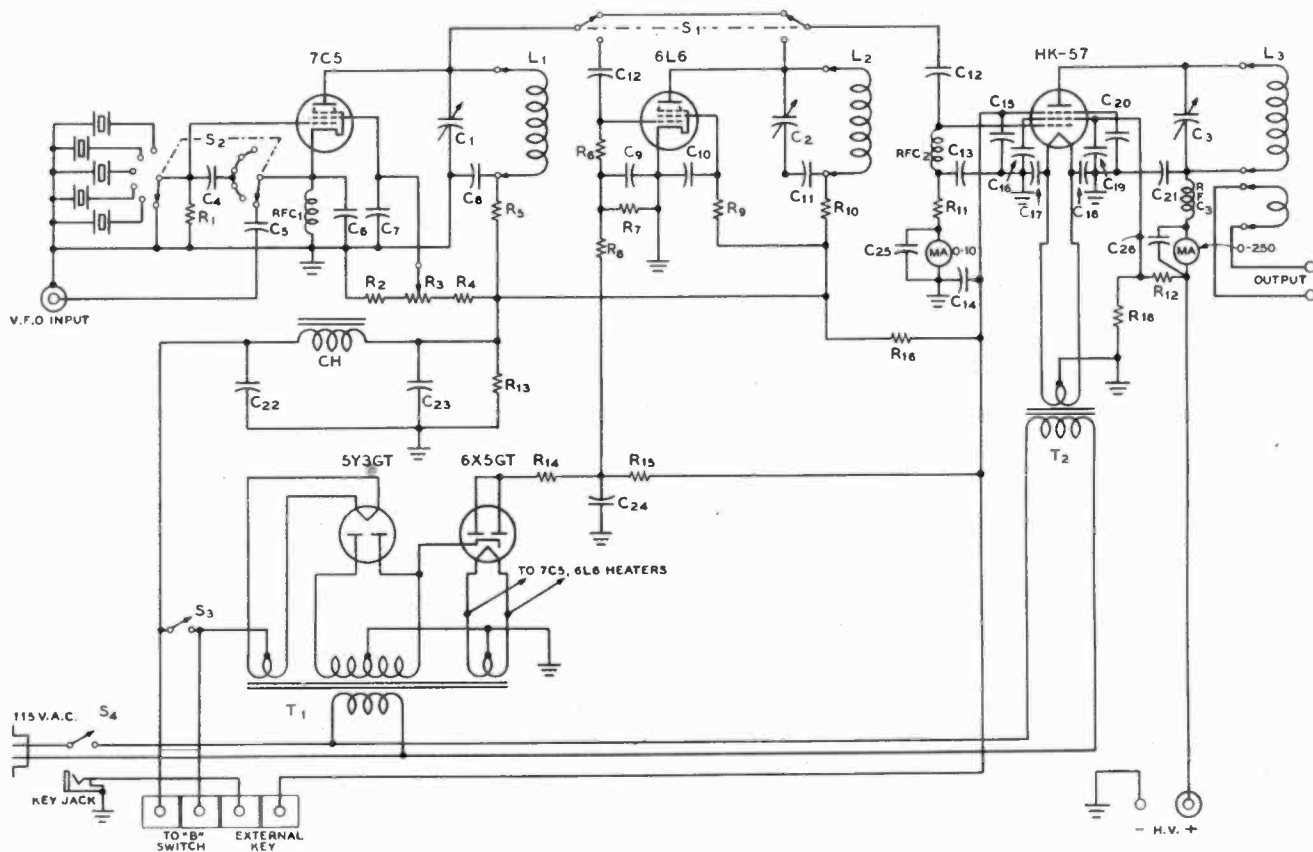

Figure 32.

SCHEMATIC DIAGRAM OF THE 150-WATT EXCITER/TRANSMITTER.

- | | | | |
|--|---|---------------------------------------|---|
| C ₁ —140- μ fd. variable capacitor | C ₁₃ —0.003- μ fd. 500-volt mica | R ₁ —39,000 ohms, 2 watts | R ₁₇ —50,000 ohms, 20 watts |
| C ₂ —50- μ fd. variable capacitor | C ₁₄ —0.01- μ fd. 600-volt tubular | R ₂ —100 ohms, 2 watts | RFC ₁ , RFC ₂ —2.5-mh. 250-ma. r-f choke |
| C ₃ —100- μ fd. 0.077" plate spacing | C ₁₅ , C ₁₆ , C ₁₇ , C ₁₈ , C ₁₉ , C ₂₀ —0.003- μ fd. 500-volt mica | R ₃ —100,000 ohms, 2 watts | RFC ₃ —1-mh. 300-ma. r-f choke |
| C ₄ —10- μ fd. ceramic fixed | C ₂₁ —0.002- μ fd. 2500-volt mica | R ₄ —22,000 ohms, 2 watts | S ₁ —2-pole 2-throw ceramic |
| C ₅ —0.003- μ fd. midget mica | C ₂₂ , C ₂₃ —8- μ fd. 450-volt elect. | R ₅ —68,000 ohms, 2 watts | S ₂ , S ₃ —S.p.s.f. toggle sw. |
| C ₆ —100- μ fd. midget mica | C ₂₄ —8- μ fd. 450-volt elect. | R ₆ —100 ohms, 2 watts | T ₁ —700 v. c.t., 120 ma.; 5 v. 3 a.; 6.3 v., 4.7 a. |
| C ₇ , C ₈ , C ₉ , C ₁₀ , C ₁₁ —0.003- μ fd mica | C ₂₅ , C ₂₆ —0.003- μ fd. 500-volt mica | R ₇ —8200 ohms, 2 watts | T ₂ —5 volts 6 amperes |
| C ₁₂ —50- μ fd. midget mica (both) | | R ₈ —50,000 ohms, 20 watts | CH—10.5-hy. 110-ma. choke |
| | | R ₉ —50,000 ohms, 20 watts | Coils—See coil table |
| | | R ₁₀ —5000 ohms, 10 watts | |
| | | R ₁₅ —47,000 ohms, 2 watts | |
| | | | |

Note: The junction between C₂ and C₁₁ should be grounded.

It is possible to use one of the recently announced 4-65A beam tetrodes in the final amplifier stage of this exciter transmitter if a few changes are made. T₂ is changed so that it supplies 6 volts at 3.5 amperes instead of 5 volts at 5 amperes as required for the HK57. Since the 4-65A is a tetrode and not a pentode, suppressor keying is not possible. However, if the screen of the 4-65A is fed through a 2000-ohm protective resistor from the 300-volt power supply on the chassis, grid-block keying of the grid of the final amplifier stage may be used with the same circuit as employed with suppressor keying of the HK57. No tendency toward spurious or parasitic oscil-

lations was encountered in testing of transmitter as shown.

Power Supply A simple 300-volt 100-ma. power supply and a 350-volt grid bias supply have been included for the sake of operating convenience on the chassis for the exciter unit. A plate voltage switch has been provided on the front panel of the equipment. Terminals are brought out to the rear of the unit for external control of the plate voltage to the exciter for operation by means of an external switch or control by the main power relay if the unit is used as a component of a larger transmitter.

High-Frequency Power Amplifiers

THE r-f amplifiers shown in this chapter are typical of those which, through popular use, have become more or less standardized for frequencies up through 30 to 54 Mc. and for power outputs of 125 watts to one kilowatt. On frequencies above the 30 to 50 Mc. range special problems arise, and for this reason amplifiers and transmitters for the higher frequencies are treated separately in Chapter 23.

Most of the amplifiers illustrated are of the push-pull type because of the relative superiority of the balanced circuit over a conventional triode amplifier stage at the higher frequencies. The single-ended amplifier finds its widest application in low-power amplifier and multiplier stages, in tetrode amplifiers of which a bandswitched example is shown in the following pages, and in grounded-grid and grounded-plate triode amplifiers.

STANDARD PUSH-PULL TRIODE AMPLIFIER

Figure 1 shows a standard push-pull amplifier circuit. While certain variations in the method of applying plate and filament voltage and in obtaining bias are sometimes found, the basic circuit remains the same in all amplifiers. All of the push-pull triode amplifiers illustrated in this chapter use this basic circuit, with such minor variations as are indicated in the descriptions of the individual amplifiers.

Filament Supply The amplifier filament transformer may be placed right on the amplifier chassis, or it may be located in the power supply, if allowance is made for the voltage drop in the connecting leads. This voltage drop can reach serious proportions where amplifier tubes having low-voltage, high-current filaments are used. In any case, the filament voltage should be the correct value specified by the tube manufacturer when measured *at the tube sockets*. A filament transformer having a tapped primary often will be found useful in adjusting the filament voltage. Where there is a choice between having the filament voltage slightly high or slightly low, the higher voltage is preferable. If the amplifier is to be greatly overloaded, a filament voltage slightly higher than the rated value will give greater tube life.

Plate Feed The series plate-voltage feed shown in Figure 1 is the most satisfactory method for push-pull stages. This method of feed puts high voltage on the plate tank coil, of course, but since the r-f voltage on the coil is in itself sufficient reason for protecting the coil from accidental bodily contact, no additional protective arrangements are made necessary by the use of series feed.

The insulation in the plate-supply circuit should be adequate for the voltages encountered. In c.w. and grid-modulated stages, the insulation of the r-f choke and wiring should be capable of withstanding voltages at least as high as the plate voltage. Where plate modulation is used, the insulation should be able to withstand at least twice the d-c plate voltage. If the plate-current meter is placed in the positive lead, it, too, must have adequate insulation between the movement and case.

Grid Bias The recommended method of obtaining bias for c.w. or plate modulated telephony is to use just sufficient fixed bias to protect the tubes in the event of excitation failure and obtain the rest from a grid leak. However, the grid leak may be returned directly to the filament circuit if an overload relay is incorporated in the plate circuit, the relay being adjusted to trip immediately when excitation is removed. For grid modulation it is necessary that all the bias be obtained from a fixed source; this makes a grid leak impracticable for this class of service.

The grid leak R_1 serves effectively as an r-f choke in the grid circuit because the r-f voltage impressed upon it is very low, and no grid r-f choke is required when a grid leak is used.

Metering It will be noticed in Figure 1 that M_2 is placed in the negative-to-filament return rather than in positive high-voltage lead. This is a safety precaution. When connected as shown in the diagram, M_2 will read plate current only, as M_1 is returned to the "hot" side of M_2 instead of to the negative plate lead. This will require an extra external lead if fixed bias is used, as the positive of the bias supply cannot be connected to the negative plate voltage under these conditions without resulting in a short across M_2 . In the event that it is desired to use a common bias supply on more than one

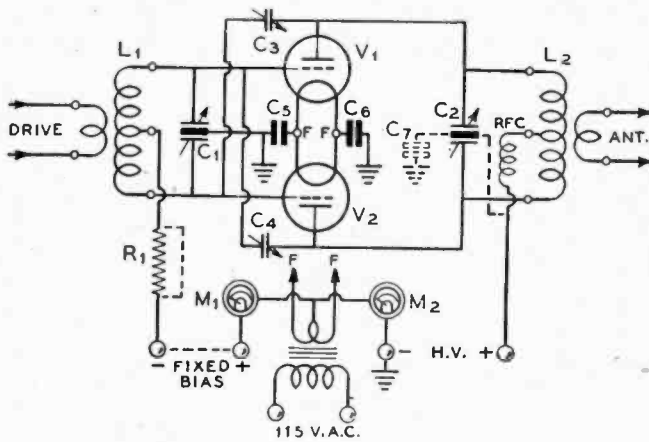

Figure 1.

STANDARD PUSH-PULL R-F AMPLIFIER CIRCUIT.

The mechanical layout should be symmetrical and the output coupling provision must be evenly balanced. If it is desired to operate the amplifier stage with essentially fixed bias R_1 may be made a 200-ohm 10-watt wirewound resistor.

- C_1 —Approximately 1 $\mu\text{fd.}$ per meter of wavelength per section.
 C_2 —Refer to plate tank capacitor design data in Chapter 6.
 C_3, C_4 —Maximum usable capacitance should be greater and minimum capacitance less than the rated grid-to-plate capacitance of the tubes to be used. 50% greater air gap than C_2 .
 C_5, C_6 —0.002- $\mu\text{fd.}$ mica, or larger
 C_7 —0.001 to 0.006 $\mu\text{fd.}$ mica, dependent upon operating conditions of amplifier and characteristics of modulation transformer if the stage is to be plate modulated.
 R_1 —Of such value that normal rated grid current will produce rated grid bias including any fixed bias. Wattage equal to I^2R .
 RFC—All-band r-f choke suitable for plate current of tubes.
 T_1 —Filament transformer of suitable voltage and current rating. Tapped primary desirable if transformer remote from amplifier.
 M_1, M_2 —Suitable instruments for d-c plate and grid currents.

stage having the plate milliammeter in the cathode circuit, the simple circuit for this purpose described in Chapter 25 may be used.

When measuring current in the filament return of filament type tubes, it is necessary that the stage have *either* an individual power supply or else a filament supply which is not used to supply any other *filament type* tubes (heater tubes may be operated from the same filament supply). If this requirement is not met, a meter jack will read the current being drawn by more than one stage at the same time. If desired, meter jacks or a switch may be substituted for the individual meters in Figure 1.

Plate Circuit In the circuit shown in Figure 1, the rotor of the plate tank capacitor is left "floating" (ungrounded). This permits a tank capacitor of less spacing to be used, as there is no d.c. impressed across it. When the rotor is "floating" it is imperative that the amplifier be symmetrical from a physical standpoint, and that the coupling to the external load be symmetrical. Because the rotor will be at high d.c. potential if the capacitor *should* arc over, it is advisable to use an insulated coupling between the rotor shaft and the tuning dial or knob.

In certain cases it may be found difficult to obtain equal loading (usually indicated by plate temperature in a metal-plate tube) of the two tubes in a push-pull amplifier. If there is assurance that each of the two tubes is obtaining the same amount of excitation, it may be possible to improve the equality of loading by by-passing the rotor of the plate tuning capacitor to ground. If the stage is to be plate modulated it will be

desirable to connect the rotor of the tuning capacitor to the modulated plate voltage lead directly, or through a 25,000-ohm to 50,000-ohm 2-watt carbon resistor. When the rotor is connected through a resistor the value of the resistor should be chosen low enough so that at the highest audio frequency to be transmitted the reactance of the by-pass capacitor will be of approximately the same value as the resistance of the series resistor. When the rotor is connected directly to the modulated plate voltage the by-pass capacitor is effectively across the secondary of the modulation transformer and may be considered as a portion of the network used to "build out" the modulation transformer for high-frequency cutoff as discussed in Chapter 7. When it is desired to operate a push-pull Class C r-f amplifier at very high plate circuit efficiency, a slight improvement in the overall efficiency will be obtained if the rotor of the plate tuning capacitor is by-passed to ground.

Plate tank coils for medium- and high-power amplifiers may be wound of bare or enameled copper wire (no. 14 or larger) or of the smaller sizes of copper tubing. Coils for 28 Mc. and sometimes for 14 Mc., may be made self supporting when wound with the larger sizes of wire or with copper tubing. For lower frequencies, high-grade ceramic forms may be used, or the coils may be made mechanically rigid by cementing the turns to celluloid strips.

Grid Circuit As the power in the grid circuit is so much lower than in the plate circuit, it is customary to use a split stator grid capacitor with sufficient capacitance for operation on the lowest frequency band, and also to ground the rotor. A physically small capacitor has a greater ratio of maximum to minimum capacitance, and it is possible to get a grid capacitor that will be satisfactory on all bands from 10 to 160 meters without need for external auxiliary capacitors. As both r.f. and d.c. voltages are relatively low in the grid circuit, the rotor of the capacitor can be grounded without increasing the cost appreciably, as very little more spacing will be required and the capacitor is relatively small anyhow (in comparison with the plate tank capacitor). Grounding of the rotor simplifies mounting of the capacitor, and also provides circuit balance and insures electrical symmetry. It also retards v-h-f parasitics by by-passing them to the ground in the grid circuit.

Coils for the grid circuit may in most cases be mounted on small jack-bar or tube-base type supports. Wire sizes up to no. 14 will be suitable for driving powers up to 100 watts. To restrict the field and thus aid in neutralizing, the grid coils should be physically no larger than absolutely necessary.

Layout The most important consideration in constructing a push-pull amplifier is to maintain electrical symmetry on both sides of the circuit. Of utmost importance in maintaining electrical balance is the stray capacitance between each side of the circuit and ground.

Large masses of metal placed near one side of the grid or plate circuits can cause serious unbalance, especially at the higher frequencies, where the tank capacitance between one side of the tuned circuit and ground is often quite small in itself. Capacitive unbalance most often occurs when a large plate or grid coil is located with one of its ends close to a metal panel. The solution to this difficulty is to mount the coil parallel to the panel to make the capacitance equal from each end to ground, or to place a large piece of metal opposite the "free" end of the coil to accomplish the same purpose.

Wherever possible, the grid and plate coils should be mounted at right angles to each other. If this is not practical, the coils should be separated as far as possible. A small amount of coupling between the two coils is not in itself greatly detrimental, since it can usually be balanced out by the neutralizing circuit, but the coupling will vary when coils are changed and

it will be necessary to readjust the neutralization when changing bands.

All r-f leads should be made as short and direct as possible, of course. The leads from the tube grids and plates should be connected directly to their respective tank capacitors, rather than to the coils. The connections between the coils and capacitors should be of wire or tubing at least as large as that used in the coils themselves. Plate and grid leads to the coils need not be as heavy as the tank circuit leads, and flexible tinned braid or flat copper strip may be used for these leads.

Many of the troubles so often associated with neutralizing can be obviated by running the neutralizing leads directly to the tube grids and plates entirely separately from the grid and plate leads to the tank circuits. Having a portion of the plate or grid connections to their tank circuits serve as part of a neutralizing lead, or vice versa, can often result in apparently mysterious neutralizing troubles. The importance of eliminating the common leads is shown by the fact that certain tubes designed for v-h-f work have entirely separate leads brought out from the elements for tank-circuit and neutralizing connections.

Excitation The excitation requirements for high- and medium-power amplifiers vary so widely that it is difficult to make definite general statements of the driving power which should be provided. However, a good average figure for the excitation power to modern triodes in a Class C amplifier is that it should approximate 10 per cent of the expected power output of the stage. Where extremely high efficiency in the amplifier is desired, the excitation may have to be as high as 20 or 30 per cent of the power output, and where the amplifier can be operated Class B for c-w purposes, the excitation power may sometimes be as low as 5 per cent of the power output. Pentodes and tetrodes generally require considerably less excitation than triodes of equivalent plate dissipation. Excessive excitation to pentodes or tetrodes will often result in reduced power output and efficiency. Except in the

case of pentodes and tetrodes, it is best to err on the side of excessive excitation, since the surplus will do no harm and a scarcity of excitation will cause a loss in output and efficiency.

The best rule to follow in adjusting the excitation to a triode amplifier is to use all the excitation available, and then adjust the bias until the grid current is at the rated operating figure given by the tube manufacturer. In push-pull or parallel stages, the current should be twice the value given for one tube, of course.

Single-Ended Stages Most of the preceding discussion, except the section on circuit balance, applies equally well to single-ended as well as push-pull stages.

Even in single-ended stages, however, it is desirable to maintain capacitive balance to ground from both sides of the plate circuit when a split-stator plate capacitor is used to obtain neutralizing voltage. In the single-ended stage, capacitive balance is obtained by *adding* a capacitance from the "free" end of the plate tank to ground, to make up for the tube's plate-filament capacitance across the other side of the circuit. The balancing capacitance may be obtained by placing an actual capacitor equal to the plate filament capacitance between the free end of the tank circuit and ground, or in the case of tubes having a low plate-filament capacitance, by locating the plate coil so that its free end is close to the chassis or panel.

Because the single-ended circuit is not inherently balanced to ground, the necessity of obtaining proper ground connections is all-important. The filament, grid, and plate by-pass capacitors should all be returned by the shortest possible *separate* leads to a common point on the chassis. Grounding these capacitors to widely separated points on the chassis, or to a common ground bus, is quite likely to lead to difficulties with feedback or instability due to coupling between the various circuits in the chassis or common lead. The connection between the filament by-pass capacitors and chassis should be as short as possible, with the other by-pass capacitors grounded to the point where the filament by-passes connect to the chassis. At

Figure 2.
FRONT VIEW OF THE MEDIUM-POWER GENERAL-PURPOSE AMPLIFIER.

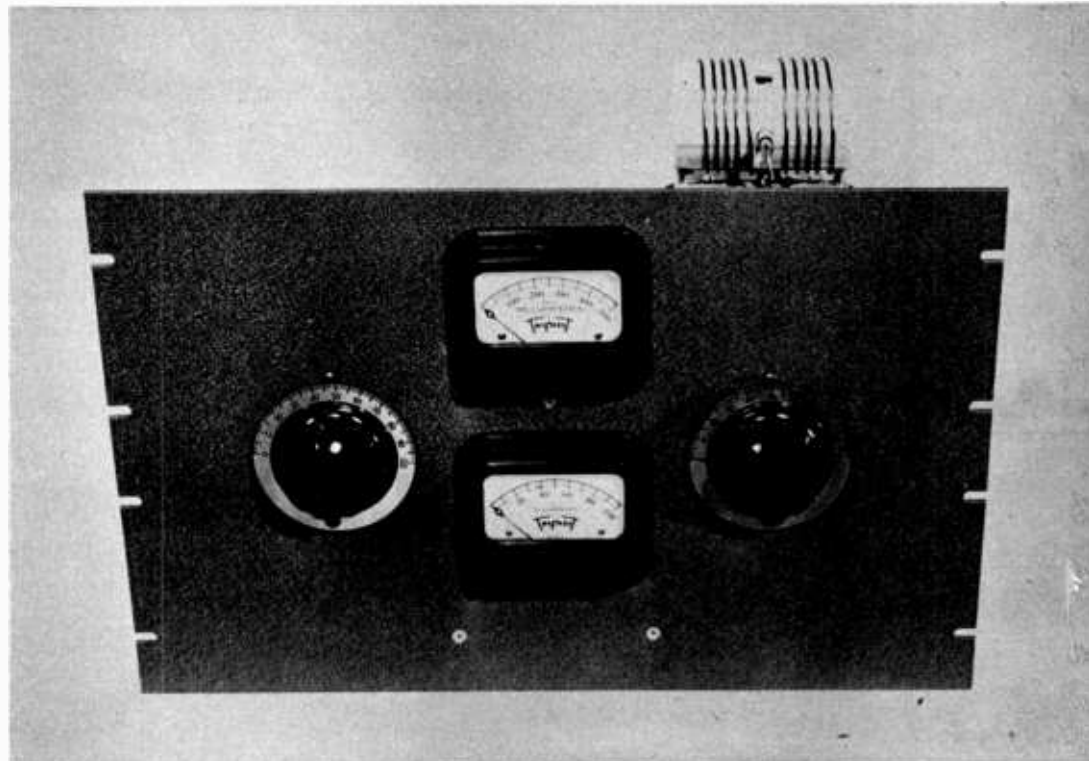

the higher frequencies it may be desirable to ground directly one side of the filament and then to by-pass the other side of the filament and all other by-pass capacitors to the grounded filament terminal.

The illustrations in this chapter will be found useful for the purpose of furnishing ideas for possible mechanical layouts. All the amplifiers shown have proven to be stable in operation and free of any parasitic oscillations. All of the arrangements shown permit relatively short r-f leads, but it is not necessary to use the particular tube types chosen in these examples. The individual constructor will often find it advisable and instructive to alter the designs to suit components on hand, or to use different tubes than those shown.

GENERAL PURPOSE AMPLIFIER

A medium power push-pull amplifier is shown in Figures 2 through 7. Tubes of a number of types may be used in this amplifier with few changes. 35TG's, 8005's, 811's and HK-54's have performed excellently. A change of filament voltage together with a slight rearrangement of plate and grid leads as described, permit a wide latitude in tube types. Power outputs ranging from 350 watts when plate modulated to 450 watts for c.w. service, depending on the tube type, are possible.

The front panel is 19 x 12 $\frac{1}{4}$ inches. Viewed from the front of this panel, the grid tuning capacitor is at the left and plate tuning capacitor on the right with plate and grid millimeters in that order from top to bottom in the center. A sub-chassis, 9 $\frac{1}{2}$ x 5 x 3 inches holds the balance of the components. On the rear lip of this chassis is a large terminal for B+ together with a terminal block for filaments, ground and C-. If only one tube type is to be used, the proper filament transformer may be mounted either on this chassis as shown in Figure 3 or on the panel.

The two tube sockets are sub-mounted by means of $\frac{7}{8}$ -inch ceramic pillars to shorten the grid and plate leads. The two neutralizing capacitors are mounted between these tube sockets, facing in opposite directions to bring their terminals closer to the plate and grid terminals of the tubes. If tubes having grid

leads coming out of the envelope are to be used, clearance must be allowed to permit insertion and turning of the tubes in their sockets without the grid lead hitting the neutralizing capacitors.

The plate r-f choke is mounted vertically by its tapped ceramic core near the front of the amplifier on the chassis. Button type feed-through insulators are used for the leads from the neutralizing capacitors to the grid terminal of the socket, again to allow clearance for inserting and removing the side grid lead type of tube. Leads from the grid coil socket are brought into the side of the chassis by $\frac{7}{8}$ -inch feed-through insulators.

These grid feed-through insulators are only necessary when tubes having the grid lead in the base are used, such as the 8005, 811 and 812 types. If tubes of the 35TG and HK-54 type are used, flexible grid leads may be soldered direct from the grid clip to the neutralizing capacitors and solid wire run from there to the grid coil socket. It is advisable however, to run the center-tap of the grid coil through a feed-through insulator into the chassis so the grid isolating resistor and by-pass capacitor may be mounted out of sight and proper connection made to the C- terminal of the terminal strip. The grid meter leads are brought out of the top of the chassis through rubber grommets and the high-voltage lead through a button insulator.

Liberal use is made of 1-inch cone insulators. Two on the side of the chassis provide terminals for r-f input while two on the rear of the plate tank capacitor make convenient terminals for output. The plate coil jack strip is held by two of these insulators which are attached to a metal bracket which in turn is bolted to a supporting member of the plate tuning capacitor. To provide additional rigidity at the rear of this plate capacitor, an L shaped bracket is run to another cone insulator on the rear of the chassis.

To provide adequate isolation between grid and plate coils, the grid capacitor is mounted right side up and the five-prong tube socket is mounted underneath it by attaching ceramic pillars to a metal strap which is run the length of the capacitor. The plate tuning capacitor is mounted upside down so the plate coil will be at the top of the amplifier. The construction

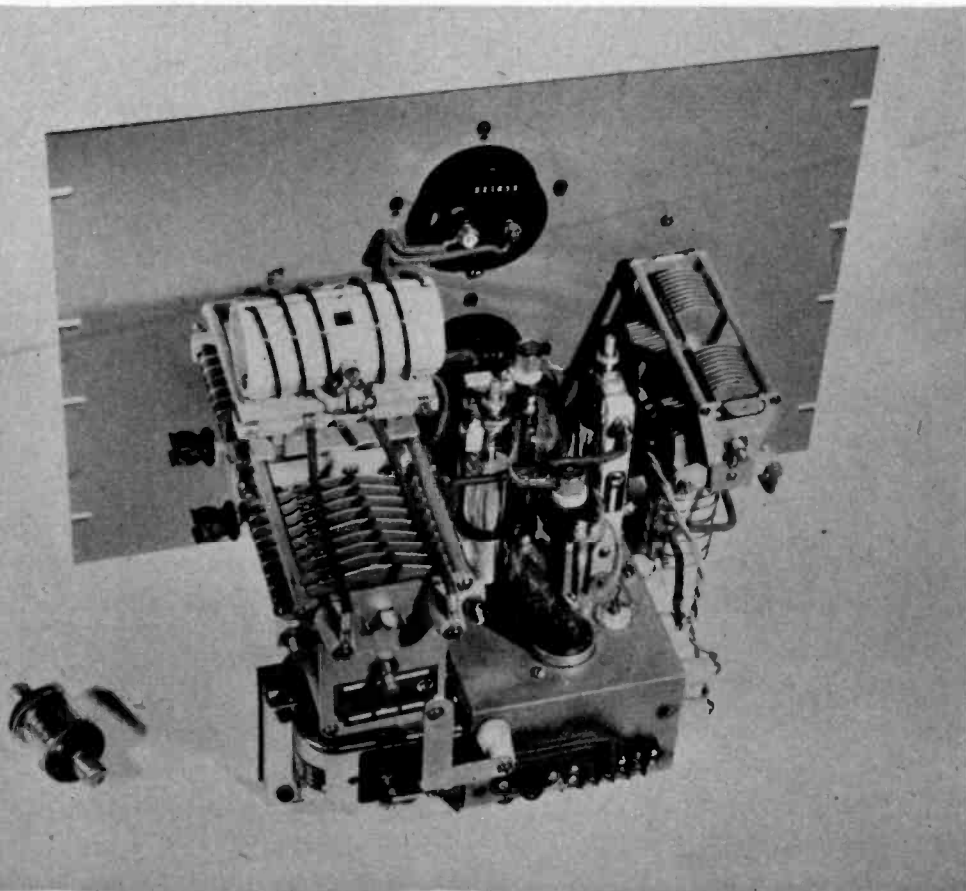

Figure 3.
REAR VIEW OF THE GENERAL-PURPOSE AMPLIFIER.
Type 8005 tubes are in use in the amplifier as shown in this photograph. The filament transformer for these particular tubes has been mounted on the side of the chassis. The 28-Mc. coils are in place in this photograph. Note that it was found necessary to remove one-half turn from each end of the Johnson 350-watt plate tank coil for 28-Mc. operation. It was similarly found necessary to remove one-half turn from each end of the 100-watt plug-in grid coil. All other coils are standard.

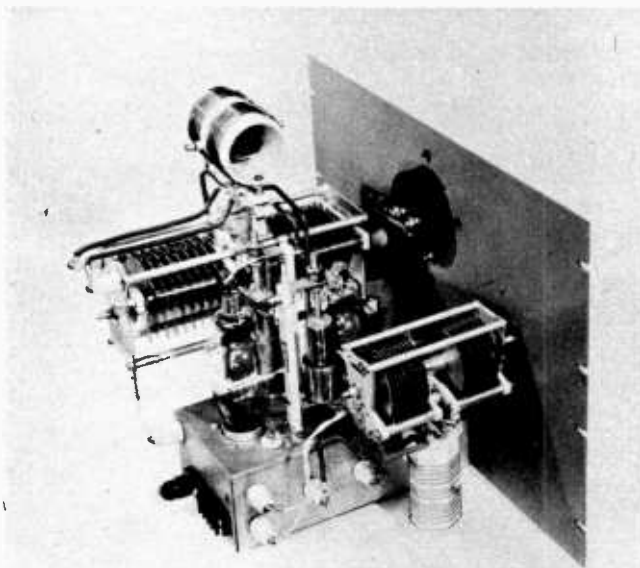

Figure 4.
SHOWING THE AMPLIFIER WITH 811 TUBES INSTALLED.

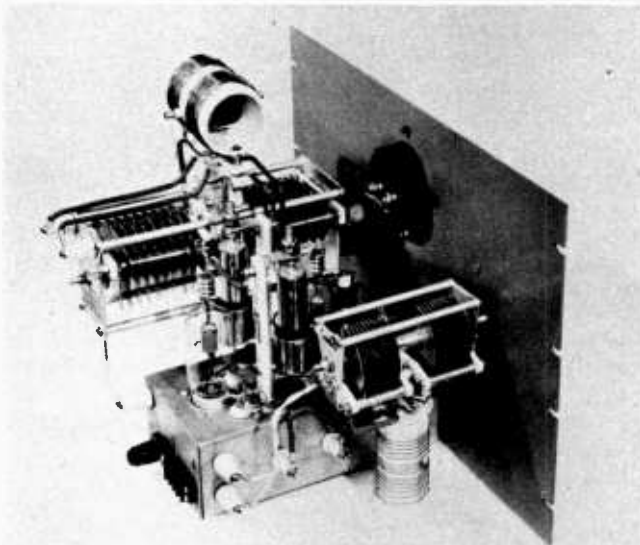

Figure 5.
35TG TUBES ARE USED IN THE AMPLIFIER IN THIS PHOTOGRAPH.

Note that the grid connection for the amplifier tubes is made to the feed-through insulator alongside the neutralizing capacitors.

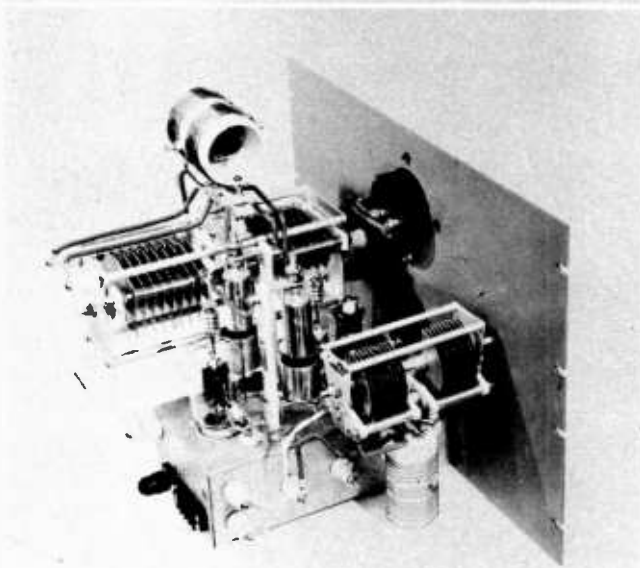

Figure 6.
IN THIS PHOTOGRAPH HK-54 TUBES ARE USED IN THE STAGE.

It is necessary to rotate the tube socket 90° when changing to HK-54 tubes from 35TG's due to differences in the basing arrangement of the two tubes.

of most variable tuning capacitors is such that it is simpler to mount coils or coil brackets on the bottom of the capacitor.

Both plate and grid coils are manufactured units. On the ten-meter coils however, half a turn is removed from each coil to provide a better tuning range in the high frequency end of that band. A handy feature of the plate coils used is the rotating antenna coupling coil inside the coil form.

The rotor of the grid tuning capacitor is grounded to the panel. The plate tuning capacitor rotor is left floating however. Mounting to the front panel is accomplished with three 1-inch cone insulators while the rotor is attached to the dial through an insulated coupling and panel bearing.

Tubes of the 35TG and HK-54 type have a very low grid-plate capacitance. With the neutralizing capacitors specified, neutralization is accomplished in these tubes at minimum setting of the capacitors. While not necessary in the amplifier illustrated, sawing off 1/2 to 3/4 of an inch of the upper cylinder will give a lower minimum capacitance and still provide sufficient range to neutralize higher internal capacitance tubes.

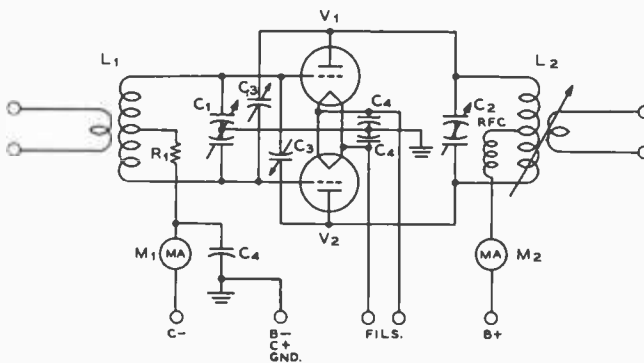

Figure 7.
SCHEMATIC DIAGRAM OF THE STANDARD PUSH-PULL AMPLIFIER SHOWN.

This standard amplifier circuit with but minor variations is used with medium-frequency medium-power r-f amplifier stages. In some cases it may be found desirable to connect a by-pass capacitor between the rotor of the plate tuning capacitor and ground. A 0.002-ufd. capacitor rated for the peak voltage which will be placed upon the amplifier (d-c plate voltage for c.w. and twice this value for AM phone) will normally be adequate for this position. If desired the lower end of the r-f choke (the end which goes to the plate milliammeter may be connected to the rotor of the plate tuning capacitor in addition to the by-pass capacitor just mentioned. In certain cases when using high-power low-filament-voltage tubes it will be found desirable to ground one side of the filament of each tube. The tubes may still be connected in series or in parallel, and filament by-pass capacitors are not required.

In the case of the particular amplifier shown in Figures 4, 5, and 6 the values of the circuit components are as follows:

- | | |
|---|---|
| C ₁ —200-μfd. per section,
0.045" spacing | C ₄ —0.003-μfd. midget mica |
| C ₂ —150-μfd. per section,
0.125" spacing | R ₁ —500-ohm 10-watt wirewound |
| C ₃ —2-12 μfd. neut. capacitors | RFC—500-ma. r-f choke |
| | Coils—See Buyer's Guide |

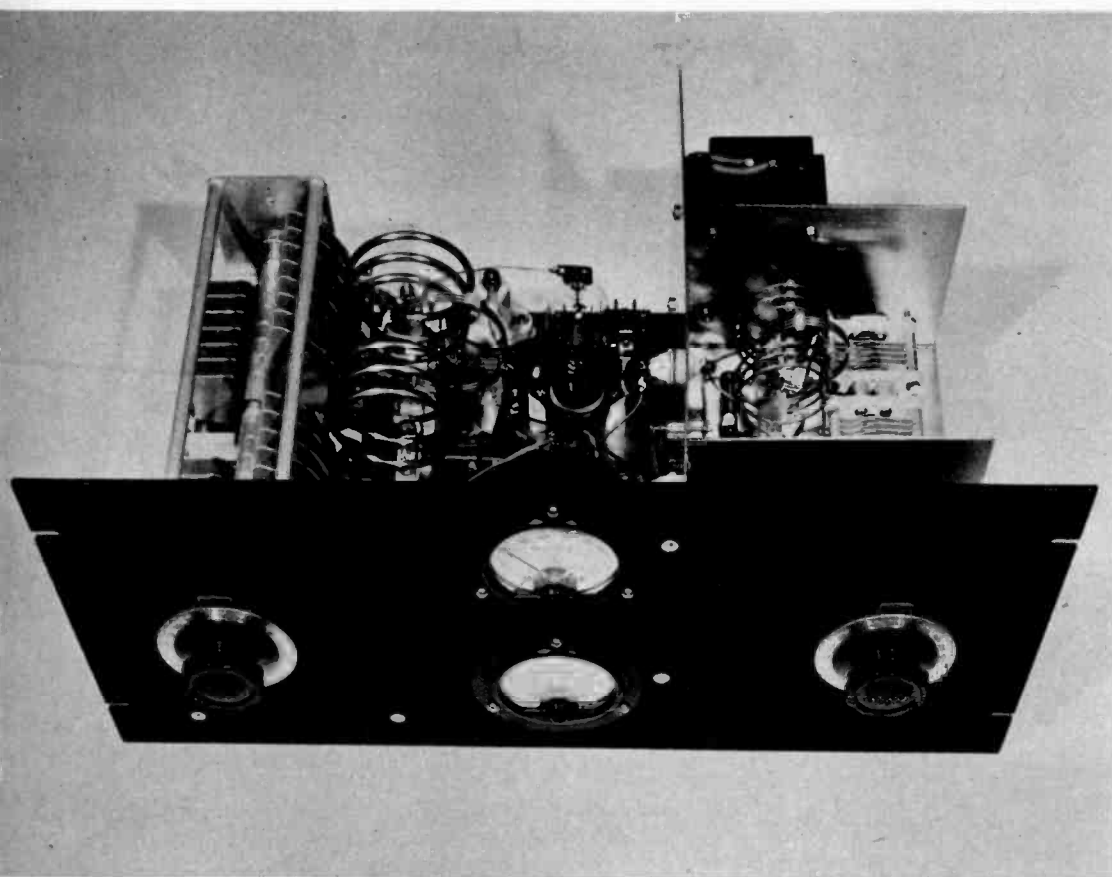

Figure 8.
TOP VIEW OF THE 8 $\frac{3}{4}$ -INCH
PANEL AMPLIFIER WITH
3C24 TUBES.

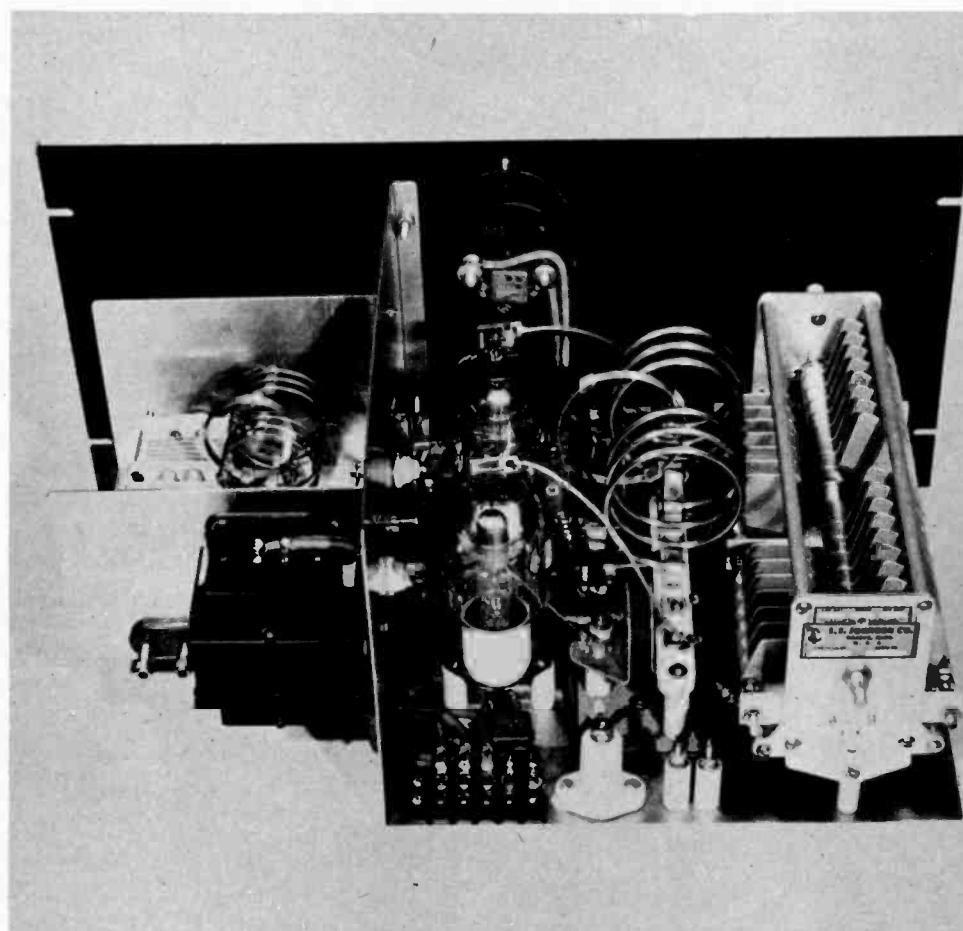

Figure 9.
REAR VIEW OF THE SHORT-
PANEL AMPLIFIER WITH HK-
54 TUBES.

*The shape of the aluminum pieces
and the placement of components
can be seen clearly in this photo-
graph.*

The 500-ohm resistor R_1 , while providing a small amount of grid leak bias, is primarily used as a form of r-f choke and isolating resistor for the grid circuit, increasing circuit stability. Grid bias of the value necessary for the particular tubes used, may be obtained from a fixed source, by grid leak or by a combination of both. Grid excitation required will also depend on the tube type and will range from 40 to 65 ma. An exciter having an output of 30 to 40 watts will be adequate to excite this amplifier on either 'phone or c.w. An 807 or other tube of equivalent output will provide this necessary power.

Link coupling would be used between the exciter output and the input of this amplifier.

If constructed as shown, no parasitics or tendency toward self-oscillation will be evident with the tube types recommended. With correct excitation and grid bias, the amplifier is completely linear under 100 per cent plate modulation conditions.

AMPLIFIER FOR LIMITED PANEL HEIGHT

Figures 8 and 9 show a slightly different method of construction from that used in the amplifier just described. By mounting the grid and plate tank coils alongside their respective tuning capacitors it is possible to reduce the panel height required for the unit from 12¼ inches on the amplifier just described to 8¾ inches on the unit shown in Figure 9. In addition to mounting the coils alongside their respective capacitors the amplifier is constructed on two simple bent pieces of metal instead of a height-consuming chassis.

The configuration of the two bent pieces of 1/16-inch aluminum can be seen in the two photographs. The aluminum sheet was marked, sawed and filed to shape in the flat piece, and then bent on the "break" in a local tinshop. Note that the tube sockets are mounted above the metal base by means of standoff pillars.

The tuning capacitors used are essentially the same as those built into the amplifier just described, but B&W type JVL inductors are used as grid coils and TVL 500-watt coils are used in the plate circuit. Since it was contemplated to use only low-capacitance side-grid tubes such as the 54, 24G, and 35TG the neutralizing capacitors were made from small pieces of aluminum sheet. The strips are 1¼ inches wide and the facing area between the two plates is 1¼ by 1¼ inches. The mounting hole on the movable plate has been slotted so that this plate may be moved back and forth to facilitate neutralization. Larger manufactured neutralizing capacitors may be used if it is desired to use tubes with higher grid-to-plate capacitance in the amplifier. The stationary plate for the neutralizing capacitors shown is attached to the bottom of the jack base for the plate tank coils.

KILOWATT AMPLIFIER FOR T-125's OR 810's

The final amplifier stage for a one-kilowatt transmitter may be constructed comparatively inexpensively around a pair of T-125 or 810 tubes in the manner illustrated in Figure 10. Such an amplifier would normally be operated at a plate potential of 2000 to 2500 volts at a plate current of 500 or 400 ma. The tubes require an actual driving power of 25 to 40 watts for the pair so that 60 to 80 watts of excitation power should be available. The operating grid bias should be 180 to 200 volts for c-w operation at a grid current of 70 to 100 ma. For radiotelephony the bias should be 300 to 350 volts at approximately 100 ma. of grid current. The operating plate voltage for phone use should be limited to 2000 volts.

All components for the amplifier are standard manufactured units. The plate tank capacitor is a Johnson 150DD70 and the grid tank capacitor is a Johnson 200ED20. Johnson 100-watt plug-in coils are used in the grid circuit and the one-kilowatt series is used in the plate tank circuit. The grid and

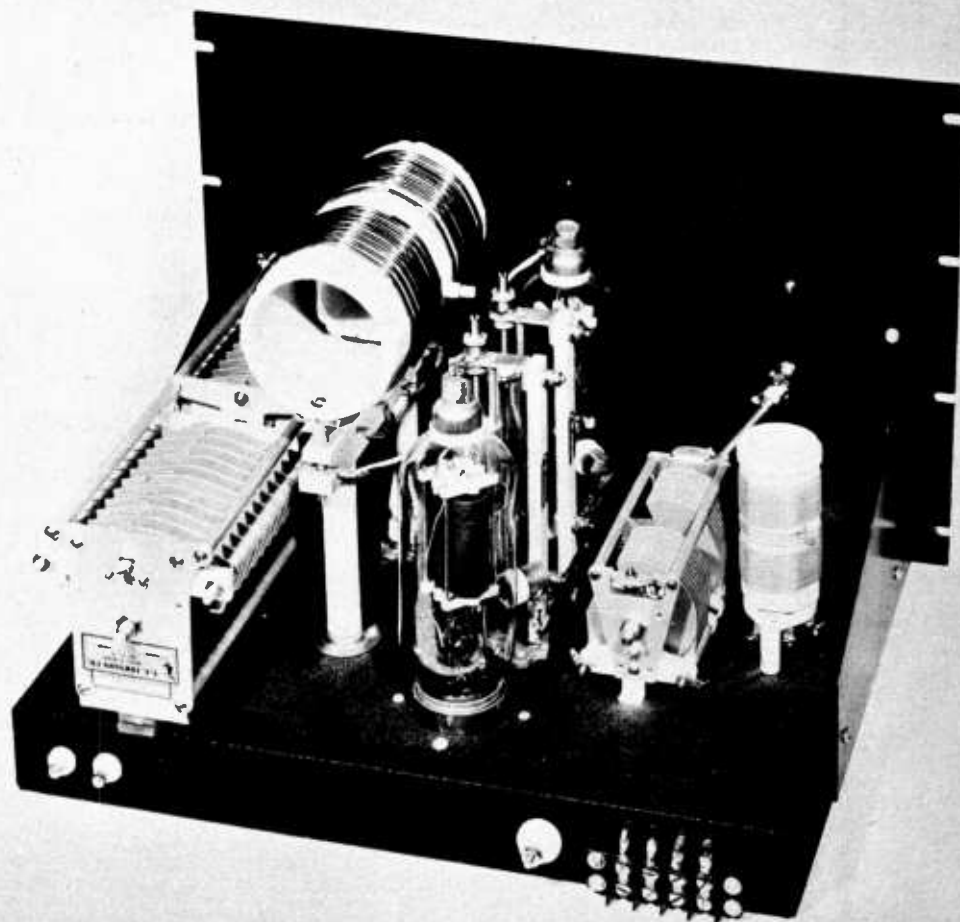

Figure 10.
REAR VIEW OF THE T-125/
810 KILOWATT AMPLIFIER.
Type 810 tubes are shown in place
in this photograph of the amplifier.

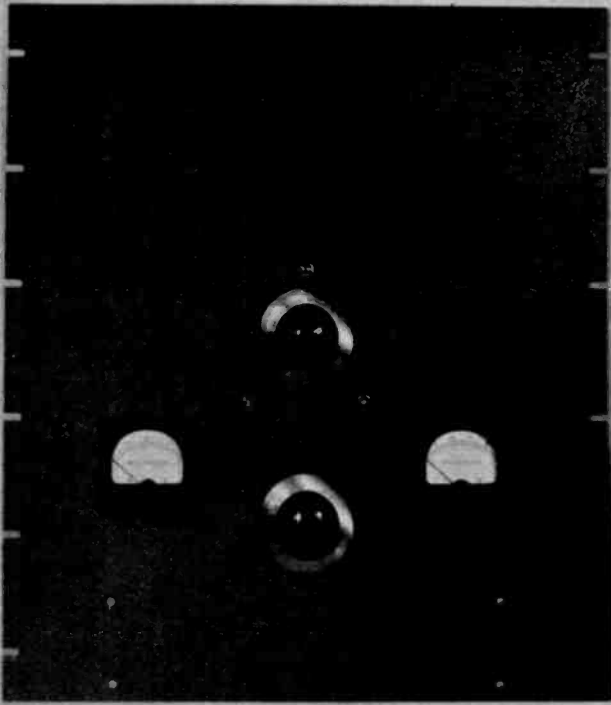

Figure 11.
FRONT-PANEL VIEW OF THE HK-254 AMPLIFIER.

Figure 12.
REAR VIEW OF THE HK-254 AMPLIFIER SHOWING THE METHOD OF CONSTRUCTION AND THE TYPE OF VACUUM PADDER CAPACITOR USED.

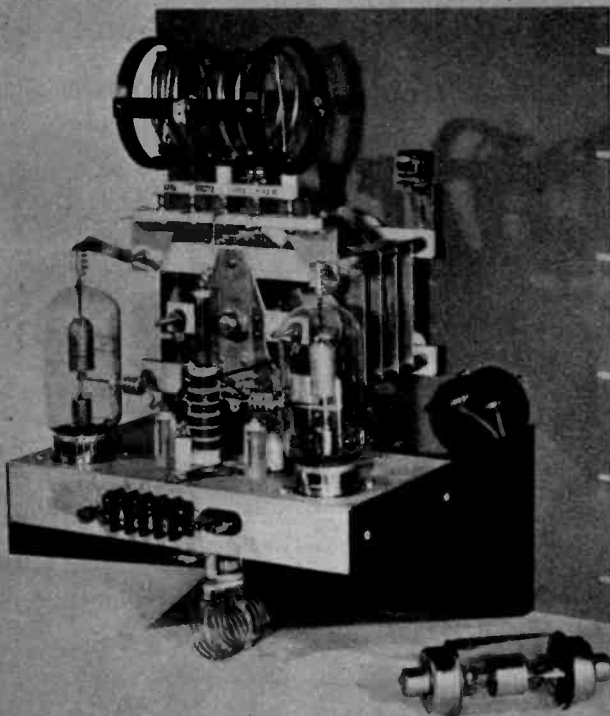

plate coils may be used without change if T-125 tubes are used but if 810 tubes are employed in the amplifier it will be necessary to trim the 14-Mc. coils due to the larger plate-to-filament capacitance of the 810 tubes. It was found necessary to remove one turn from each end of the 14-Mc. plate tank coil to hit resonance.

This amplifier was also in use for a period of time with 250TH tubes in the sockets in place of the tubes mentioned above. If 250TH tubes are used it is only necessary to change the filament voltage, the grid and plate connectors, and then to wind out the N-250 neutralizing capacitors to the lower inter-electrode capacitance of the 250TH tubes.

PUSH-PULL HK254 AMPLIFIER

The high-power amplifier illustrated in Figures 11, 12, and 13 is supported entirely from a standard 21-inch rack panel. The components associated with the amplifier are mounted on a 13 x 7 x 2 inch standard chassis which is mounted 6 inches behind the panel by means of a pair of standard 13-inch chassis-holding brackets. The construction of the amplifier is shown quite clearly in the accompanying photographs.

This amplifier is capable of inputs up to 750 watts on either c.w. or AM phone on frequencies from 3.5 through 30 Mc. Maximum operating plate voltage for coils of the type shown is approximately 2500 volts. If B&W HDVL coils are used in place of the coils of the general type of their 3400 series, inputs up to one kilowatt at 4000 volts on c.w. may be used. The particular 28-Mc. coil shown was made by cutting down an 11-14 Mc. surplus coil to 5 turns. Two and one-half turns are used on each side of center with the last half turn brought directly down to the terminal as shown in Figure 12.

The plate tank capacitor for the amplifier is a B&W type CX-40A-N3 with built-in neutralizing capacitors. This tuning capacitor has ample range for the 20, 15, 10 and 11 meter bands, but additional padding capacitance will be required on the 40 and 80 meter bands. It is recommended that a 50- μ fd. vacuum capacitor of the type shown in the photograph of Figure 12 be used on the 80-meter band and a 25- μ fd. capacitor of the same type be used on the 40-meter band.

Figure 13.
VIEW LOOKING UNDER THE CHASSIS OF THE HK-254 AMPLIFIER.

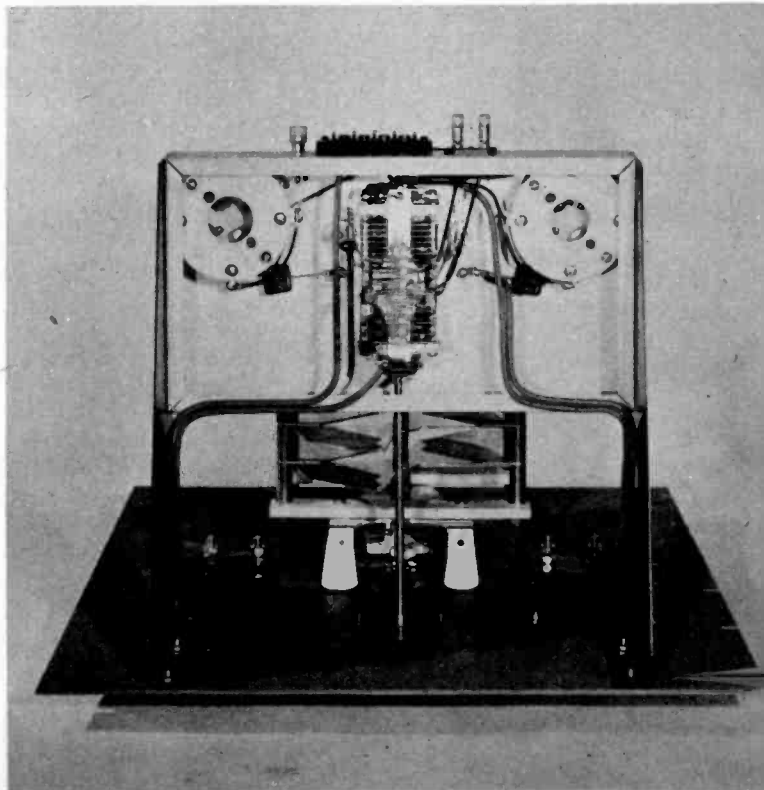

The grid tank coils are 50-watt B&W variable-link coils. Approximately 60 watts of excitation power should be available for phone operation, although c-w or FM operation can be obtained with as little as 40 watts of driving power. Normal grid current on the amplifier is 90 ma. for the two tubes and the plate current may be as high as 450 ma. if the plate dissipation rating of the tubes is not exceeded.

ONE KILOWATT 250TH AMPLIFIER

The unit shown in Figures 14, 15 and 16 is very similar in construction to the 254 amplifier previously described with the exception that the panel has been cut out for the insertion of glass viewing windows, and that 250TH tubes are used. This amplifier runs very cool at one kilowatt input on frequencies from 3.5 through 54 Mc. for either c-w, plate modulation, or FM, and it may also be used for grid modulation. Approximately 100 watts of driving power should be available for phone operation; 50 watts of driving power is required for FM or c-w operation; and 10 to 15 watts of driving power is required for grid modulation.

Coils Both grid and plate circuit coils for the bands of 3.5 through 30 Mc. are of the manufactured type. Johnson 1 kw. coils are used in the plate circuit and the 350-watt series of coils by the same manufacturer is used in the grid circuit. Coils for the 6-meter band, which are shown in place in the transmitter in the photographs, are constructed as follows:

The plate tank coil consists of 4 turns of 3/16-inch copper tubing, 1 3/8 inches inside diameter, with 3 1/2-inch mounting centers. The grid coil consists of 4 turns of no. 12 enamelled wire, 1 inch in diameter, 1 1/2 inches in winding length, mounted on a National XR13A coil form and attached to a Johnson 668 plug strip.

Capacitors The plate tank capacitor is a Johnson 50CD110 and the aluminum supporting brackets for the tank coil are bolted to the center ceramic strip of this capacitor. The grid tank capacitor is a Cardwell MT100GD, and the brackets for the plug-in coils are bolted directly to the stator terminals on the capacitor. The neutralizing capacitors for the 250TH tubes consist of 2 1/2-inch diameter aluminum disks mounted on ceramic strips facing 3-inch square aluminum plates. Neutralization of the amplifier is obtained with approximately 1/2-inch spacing between adjacent faces of the neutralizing plates. It is necessary to use a 25- μ fd. vacuum capacitor across the tank coil for the 40-meter band and a 50- μ fd. vacuum capacitor for the 80-meter band. Plate voltage on the amplifier may be 3000 to 3500 volts for c.w., FM or plate modulation on frequencies as high as 30 Mc. For grid modulation 4000 to 4500 volts may be used up to 30 Mc. and 3000 volts up to 54 Mc. For c.w. or plate modulation on the 50-Mc. band the plate voltage should be limited to about 2250 volts.

Filament Circuit The center tap of the filament transformer has been grounded as has been one leg of the filament of each tube. This places the two tubes in series and allows the use of a 10-volt, 10-ampere filament transformer instead of the 5-volt, 20-ampere filament transformer which would be required if the two tubes were in parallel. This filament arrangement has another advantage in that filament by-pass capacitors are not required when the filaments

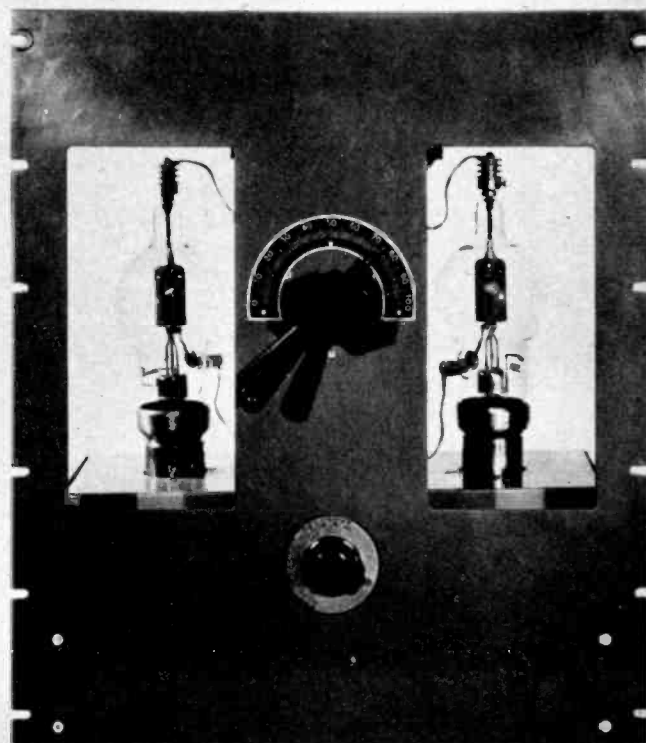

Figure 14.
FRONT-PANEL VIEW OF THE 250TH KILOWATT
AMPLIFIER.

The front panel has been cut out so that glass viewing windows could be inserted.

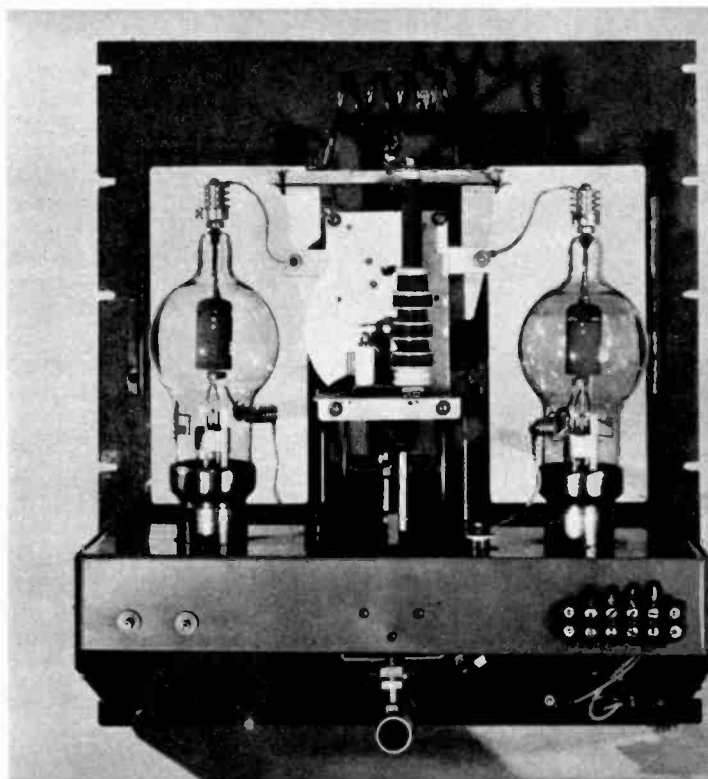

Figure 15.
REAR VIEW OF THE 250TH AMPLIFIER.
The 50-Mc. coils are in place in this photograph.

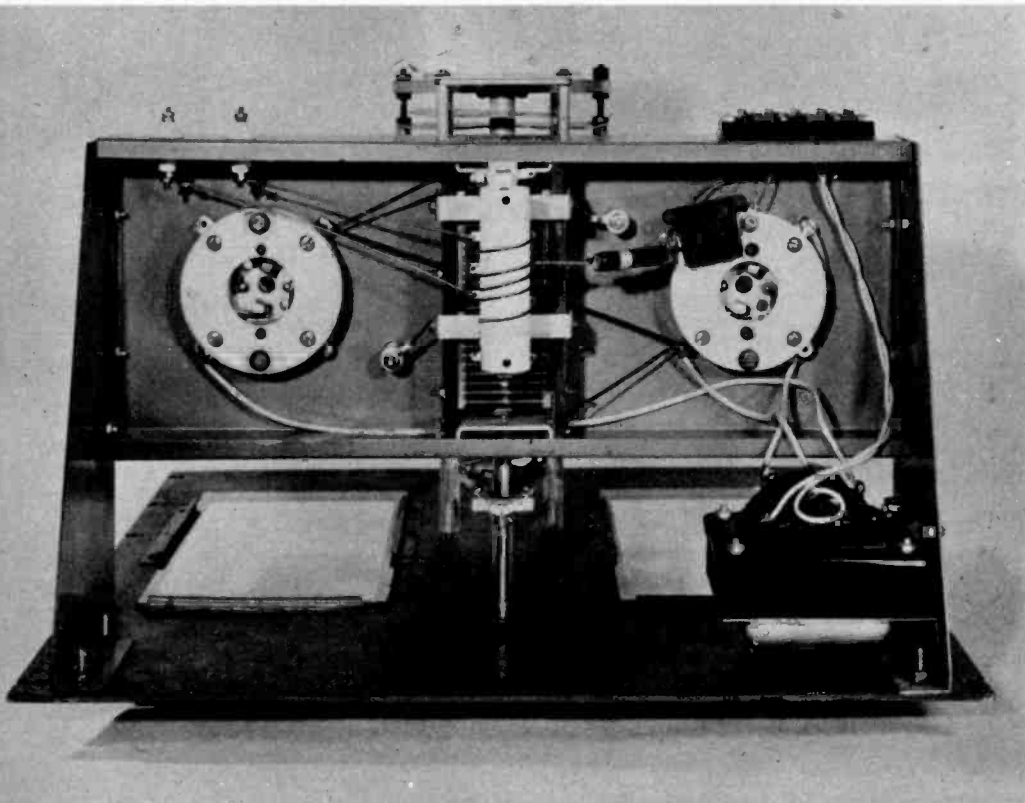

Figure 16.
UNDERCHASSIS VIEW OF THE
PUSH-PULL 250TH AMPLI-
FIER.

are operated with one filament lead of each tube connected directly to ground.

Normal grid current on the amplifier will be 5 to 15 ma. for grid-bias modulation, 80 to 150 ma. for c-w or FM, and 100 to 160 ma. for plate modulation. Maximum rated plate current for the two tubes is 0.7 ampere.

BEAM-TETRODE AMPLIFIERS

The beam tetrode tube is very well suited to use as a high-power r-f amplifier in a transmitter where it is desired to use a minimum number of stages in the exciter. Such tubes have very low excitation requirements and are capable of giving high-efficiency operation and good modulation linearity for radiotelephony. However, the high degree of power sensitivity of such stages means in itself that unusual precautions must be taken to insure that coupling between the output circuit and the input circuit must be held to an absolute minimum. This means that shielding must be used to minimize electrostatic and electromagnetic coupling and that mutual impedances between the input and the output which may exist in the screen and cathode circuits must be held to a low value.

The fact that a beam tetrode amplifier has the screen-supply circuit in addition to the grid and plate circuits means that further considerations are involved as compared to a triode amplifier. The proper values of screen voltage and screen current is just as important in a beam tetrode amplifier as the voltages and currents in the plate and grid circuits. The value of the screen voltage has just as important an effect on the plate current as does the grid voltage. And on the other hand the screen current is a function of both the plate voltage and the grid voltage. Assuming a fixed value of loading on the plate circuit of a tetrode amplifier, the screen current will increase directly with the grid current. Therefore the rated maximum value of grid current should never be exceeded, not necessarily from the standpoint of the grid itself, but because the screen current will be excessive with rated screen voltage

if the grid current is excessive. Since all the power going to the screen of the tube is dissipated directly in the screen it is a simple matter to determine the screen dissipation to determine whether or not the rating is being exceeded.

If the screen circuit is being fed from a higher voltage supply through a dropping resistor a high value of excitation and hence a high value of screen current will result in too low screen voltage which will reduce the efficiency and power sensitivity of the amplifier stage.

For plate modulation of a beam-tetrode amplifier, one of the most satisfactory methods of obtaining screen-voltage modulation in accordance with the plate-voltage variation is to use a series screen impedance. The impedance may be either a relatively high value of resistance from the plate-voltage supply or a combination of a choke and a moderate value of resistance fed from the low-voltage screen supply. Both these methods have been used in the transmitters described in Chapter 26.

150-WATT PUSH-PULL 807 AMPLIFIER

The push-pull 807 amplifier shown in Figures 17 and 18 is designed for use on 80, 40, 20, 10 and 6 meters. Plug-in coils provide quick change from one band to another and permit construction of the entire amplifier on a 19 x 7 inch panel. By using the type of combination tube socket mounting and shield illustrated, it is possible to eliminate the need for a sub-chassis. Mounting the tubes horizontally brings plate and grid leads close to their respective tuning capacitors and permits good isolation of these two parts of the circuit. Automatic protection for the 807's in event of excitation failure is provided by the 6Y6.

The location of the major components can be seen from the illustrations. At the base of the tube sockets are mounted the grid tuning capacitor, filament transformer, 6Y6 tube, grid coil socket and input terminal strip. The plate coil jack strip is mounted on 4½-inch ceramic rods which allows a 2¼-inch diameter meter to be mounted on the panel between the two

Figure 17.
PANEL VIEW OF THE P-P 807
AMPLIFIER SHOWING ALL
COILS.

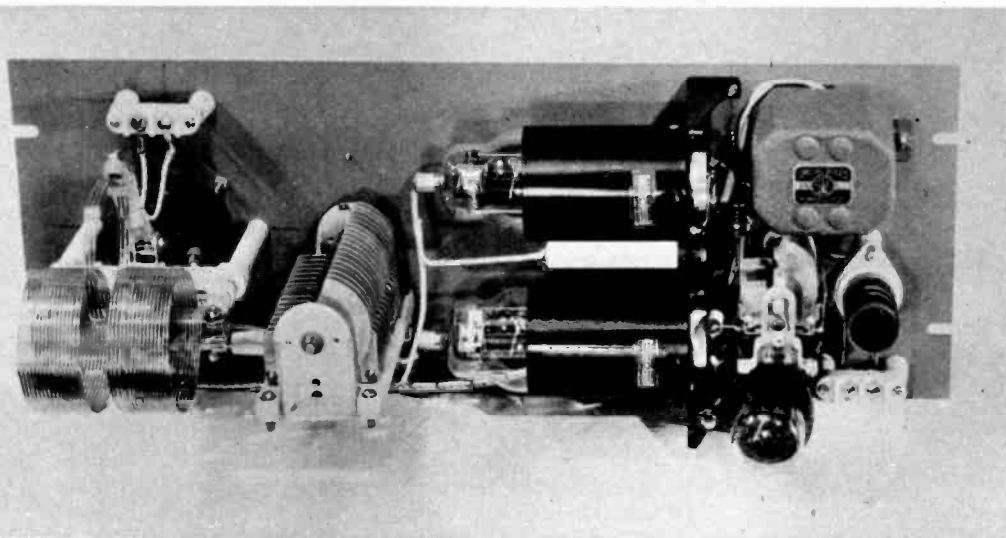
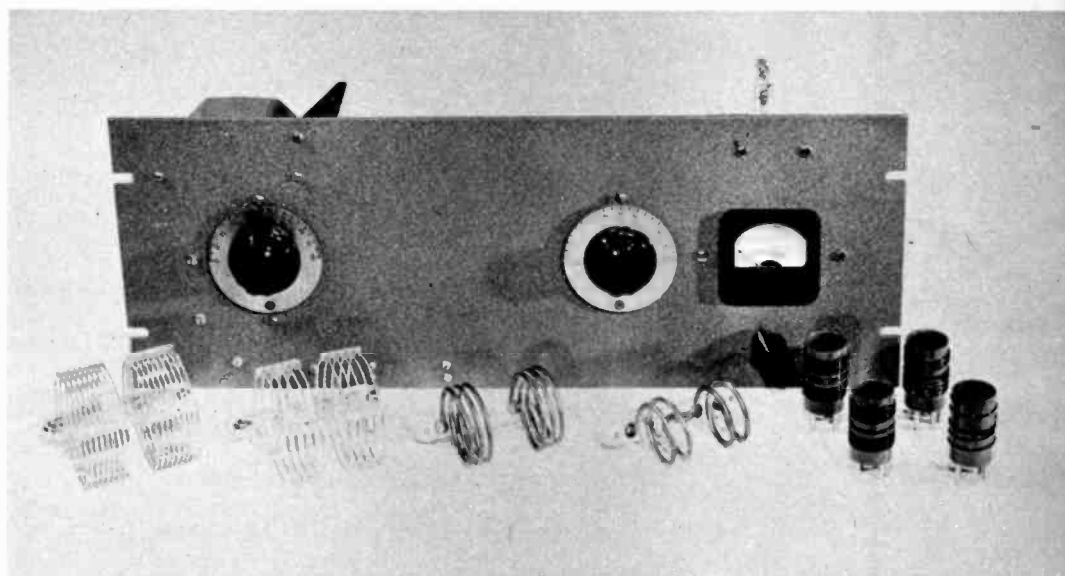

Figure 18.
REAR VIEW OF THE PUSH-
PULL 807 AMPLIFIER.

rods and under the plate coil. The output terminal strip is above this meter. Below the meter is a double-pole, three-position rotary switch used to measure either grid or plate currents or disconnect the meter entirely. The radio frequency choke is mounted by means of its cone mounting insulator and a small angle bracket to the plate tuning capacitor.

The ceramic-type grid-coil socket is mounted on 3/4-inch cone insulators as are the input and output terminal strips. Both plate and grid tuning capacitors have their rotor grounded. Mounting to the front panel is by means of the threaded front rotor bearings. Grid coils are wound on 1-inch diameter, 5-prong coil forms using a split winding with the link turns between. A bakelite wafer socket mounted on metal pillars is used for the 6Y6 tube. Since the 807's and 6Y6 draw but 3.05 amperes of filament current, the small filament transformer necessary to supply this is incorporated on the panel. The two 115-volt leads for this filament transformer, together with the high voltage positive and negative are brought to a four-post terminal strip on the lower edge of the panel.

Transfer of the milliammeter from grid to plate circuits is accomplished by placing 100-ohm 2-watt resistors in series with the grid return and B+ leads and switching the meter across these resistors. This eliminates the necessity of having an extra set of contacts on the rotary switch to close the circuit

not being measured, and the resistors do not alter the meter calibration appreciably. The rotary switch has a third position which disconnects the meter entirely from the circuit.

The plate tank circuit uses standard manufactured plug-in units. The antenna coupling coil is mounted on the jack strip and consequently does not require removal as coils are changed. It was found necessary to reduce the inductance of the 6-meter coil by removing the winding from the form and reducing its inside diameter from 1 5/8 inch to 1 1/4 inch, cutting

COIL TABLE FOR 807 PUSH-PULL AMPLIFIER

L ₁	
80 meters—	50 turns #28 enamelled close wound in two 25-turn coils separated 1/2 inch with an 8-turn link between.
40 meters—	26 turns #28 enamelled in two 13-turn coils spaced to occupy 3/8 inch each with 4-turn link between.
20 meters—	13 turns #24 enamelled in two 6 1/2-turn coils spaced to occupy 3/8 inch with 3-turn link between.
10 meters—	8 turns #20 enamelled in two 4-turn coils spaced to occupy 3/8 inch with 3-turn link between.
6 meters—	4 turns #20 enamelled in two 2-turn coils spaced to occupy 3/8 inch with 2-turn link between.

L₂
Manufactured 150-watt plug-in coils for all bands.

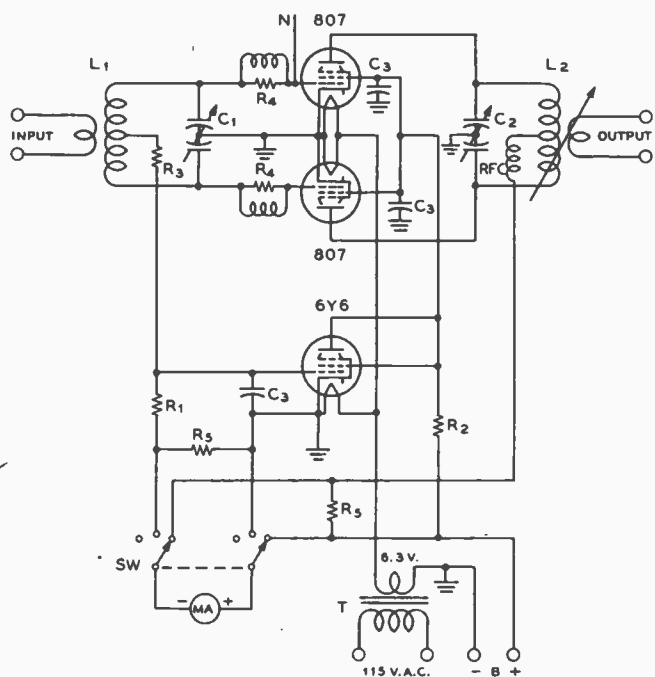

Figure 19.

SCHEMATIC DIAGRAM OF THE PUSH-PULL 807 AMPLIFIER.

- | | |
|---|---|
| L ₁ and L ₂ —See coil table | R ₂ —47 ohms, 2 watts, 7 turns bare wire wound around resistor |
| C ₁ —Dual 100- μ fd. variable capacitor | R ₃ —100 ohms, 2 watts |
| C ₂ —Dual 75- μ fd variable capacitor | M—0-300 d.c. ma. 2 $\frac{1}{4}$ inch case |
| C ₃ —0.002- μ fd. mica capacitor, receiving type | RFC—1 mh., 300 ma. radio frequency choke |
| R ₁ —7,000 ohms for c.w., 12,000 ohms for 'phone, 10 watts | SW—Two-pole three-position rotary switch |
| R ₂ —50,000 ohms, 20 watts | T—6.3 volt, 2 amp. filament transformer |
| R ₃ —470 ohms, 2 watts | |

off the surplus wire, and resoldering the coil back into the form.

Grid-leak bias is provided by resistor R₁, which also serves to bias the 6Y6 to cut-off when excitation is present. Without excitation, bias on the 6Y6 is removed and the plate current drain of this tube causes a large voltage drop to occur in screen resistor R₂, which drops the screen voltage on the 807's to a small value. This action effectively reduces the plate current

to the 807's so no damage is done to the tubes by excitation failure, as well as permitting a lower powered stage to be keyed for break-in operation. While the value of the bias resistor R₁ might have to be changed, depending on the excitation and plate voltage used, 7,000 ohms for c.w. and 12,000 ohms for 'phone will satisfy most requirements.

Resistor R₃, while providing a small amount of grid bias, is used more as a grid isolating resistor for stability than for grid bias.

While beam power tubes such as the 807 can usually be made to operate on one band without too much trouble, when operation on widely different frequencies is required, difficulties with self-oscillation and parasitics often occur. This amplifier was no exception. Ordinary neutralization was ineffective. What would stabilize operation on one band would make it erratic on another. Trial and error evolved the incorporation of parasitic suppressors R₄, made by winding 7 turns of bare hookup wire around 47-ohm resistors and inserting them in the grid leads at the tube sockets, together with .002- μ fd. by-pass capacitors wired directly on the tube sockets from screen to cathode terminals. This stabilized the amplifier except for a small tendency toward self-oscillation on 10 and 6 meters. Increasing the grid-plate capacitance of one tube by running a wire from the grid terminal to the vicinity of the plate lead and adjusting the amount of capacitance by changing the proximity of these wires to each other, completely cured the trouble.

This condition of instability on the higher frequencies, particularly where shielding is good, is due principally to screen-lead-inductance effects necessitating the introduction of in-phase voltage from the plate circuit into the grid circuit. It may sometimes be cured by series tuning the screen to ground by a small variable capacitor. The method used here, however, has the advantage of simplicity. The piece of hookup wire used to give this in-phase voltage is brought from the grid terminal of the socket through the porcelain pillar seen adjacent to one of the tube shields. It is bent into a 1-inch long piece which lies close to the plate terminal lead interconnecting the plate cap of the tube and the tuning capacitor. On bands other than 10 and 6 meters, it is moved away from the plate lead since on those bands it does exactly what it cures on the higher frequencies. An amplifier cannot be declared to be stable unless its plate current remains absolutely constant throughout the range of the plate tuning capacitor except at resonance. This condition is met in the amplifier described.

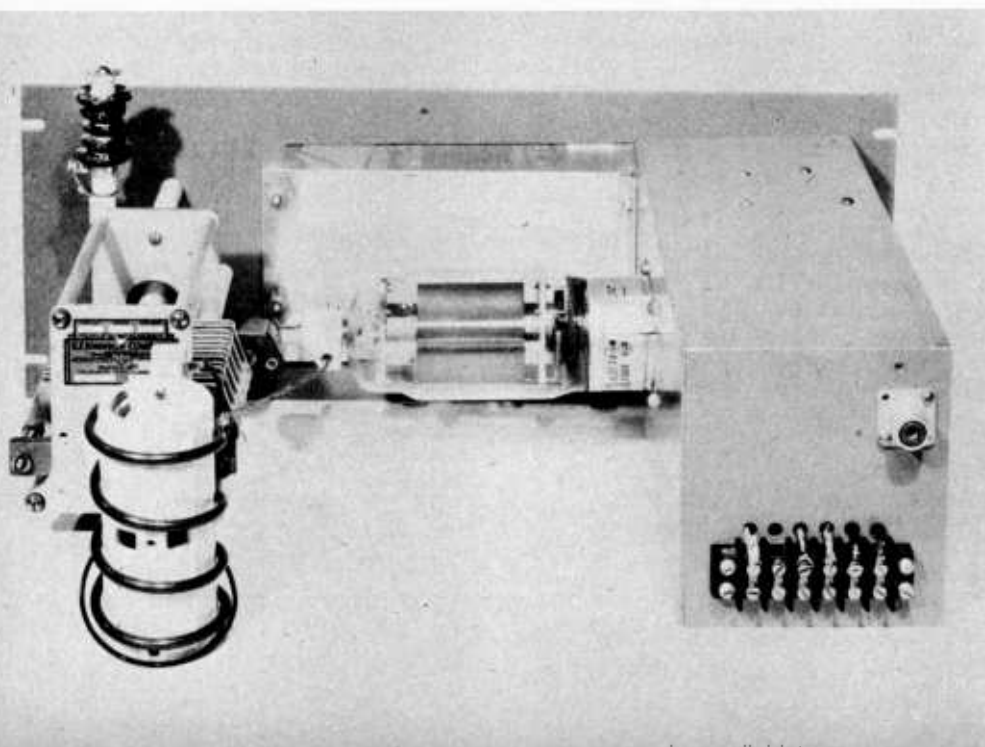
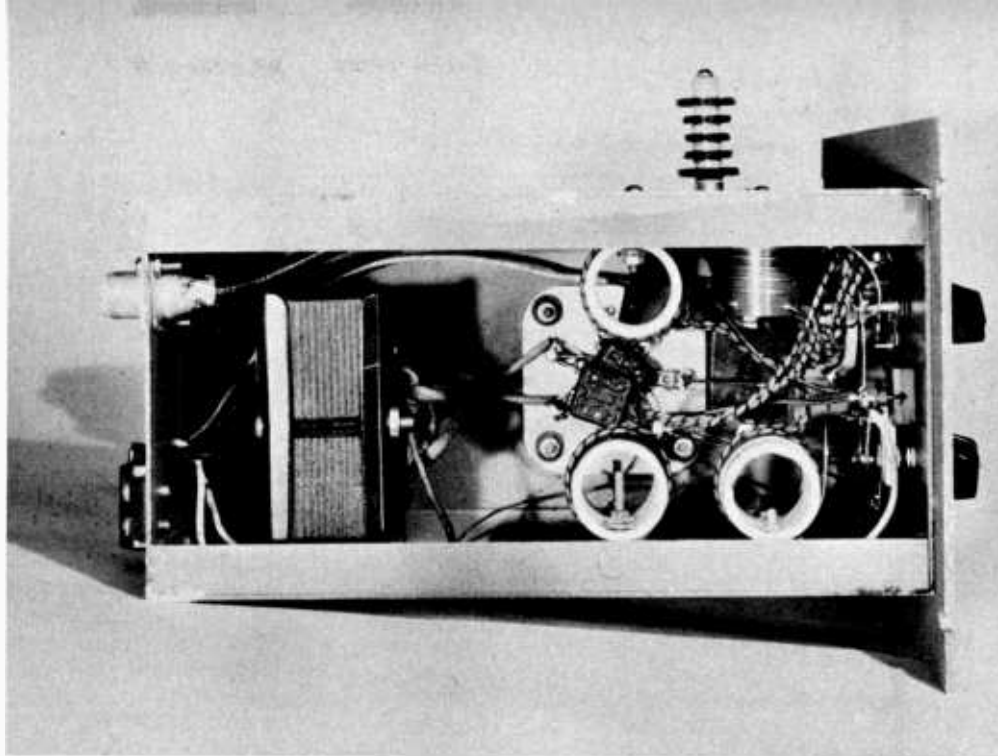

Figure 20.
REAR VIEW OF THE 813 AMPLIFIER.

Showing the amplifier removed from the rack with the 28-Mc. plate coil in place. This coil also hits the 21-Mc. band. The single-turn antenna-coupling link can also be seen in the photograph at the low-potential end of the plate tank coil. The r-f choke extending upward from the tank capacitor for the stage receives its plate voltage from the meter panel which is located directly above this amplifier in the cabinet rack.

Figure 21.
SIDE VIEW OF THE AMPLIFIER.

Showing the internal construction of the grid-filament portion of the amplifier stage. The 80, 40, 20, and 10 meter coils can be seen; the 15-meter coil is located in the same plane as the 10-meter coil and directly behind it. The coaxial input fitting for excitation to the stage can be seen on the rear of the housing.



Grid excitation should be limited to 10 milliamperes. Plate voltage and plate current should follow the tube manufacturer's specifications for c.w. and 'phone use.

BANDSWITCHING 813 AMPLIFIER

The amplifier illustrated in Figures 20 and 21 and diagrammed in Figure 22 is a unit of the 450-watt 813 transmitter described in Chapter 26. Plug-in coils are used in the plate circuit, but the grid coils for all bands are included within the completely shielded grid-circuit shield can. The coil table gives the winding data for the five coils for the 10-11, 15, 20, 40, and 80 meter bands. Each of the coils was trimmed so that it would resonate in the center of the appropriate band with the trimmer capacitor C_2 at approximately mid-scale. Quite low C

has been used on all coils so that a variable frequency exciter may be swung over the major portion of a band without any adjustment being required of C_2 . However, the plate-tank tuning capacitor C_1 must be retuned if the frequency of operation is moved more than approximately 50 kc. When tuning the exciter over a considerable frequency range C_2 should be repeaked to give grid current of 6 to 9 ma. on the 813 stage.

Neutralization of the 813 amplifier stage was found to be unnecessary as long as the amplifier is loaded even moderately by the antenna. However, for the stage to be completely stable it is important that the exciter unit be shielded in such a manner that r-f fields within the room will not be coupled back through the exciter feed line into the 813 stage. The plate circuit by-pass capacitor C_3 , consisting of 0.002- μ fd., 3500 working voltage mica, is physically attached by means of brackets between the frame of the plate tank capacitor and the

Figure 22.
SCHEMATIC WIRING DIAGRAM OF THE 813 AMPLIFIER.

- C_1 —100- μ fd. 7000-volt variable
- C_2 —15- μ fd. midget variable
- C_3 —0.002- μ fd. 3500-volt working mica
- C_4, C_5 —0.002- μ fd. midget mica
- C_6 —0.002- μ fd. 1250-volt working mica
- C_7 —0.002- μ fd. midget mica
- R_1 —5000-ohm 10-watt wirewound
- RFC—2.5-mh. 500-ma. r-f choke
- T—10-volt 5 to 8 amp. transformer
- Coils—See coil table

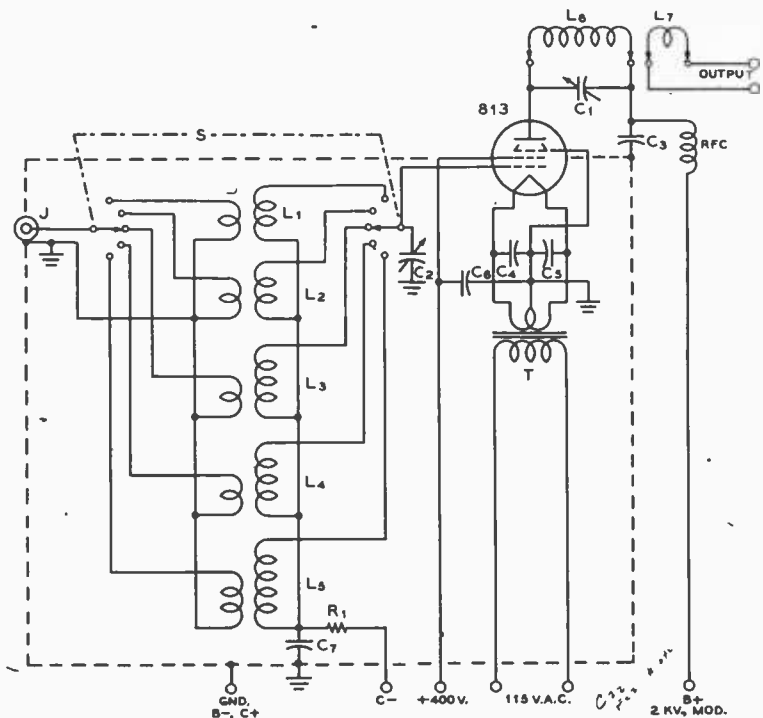

COIL TABLE	
Bandswitched 813 Amplifier.	
L ₁ —10/11 meters	6 turns no. 18 spaced to 1" on XR-2 form
L ₂ —15 meters	8 turns no. 18 spaced to 1" on XR-2 form
L ₃ —20 meters	14 turns no. 18 spaced to 1" on XR-2 form
L ₁ —40 meters	28 turns No. 24 spaced to 1" on XR-13A form
L ₂ —80 meters	57 turns no. 24 close spaced on XR-13A form
L ₁ —80 and 40 mtrs.	Johnson 350-watt coils for these bands
L ₁ —20 meters	Johnson 667 form, 8 turns 3/16" copper tubing; link, L ₁ , 2 turns no. 10
L ₁ —10/11/15 meters	Johnson 666 form, 4 turns 3/16" copper tubing; link, L ₁ , 1 turn no. 10

panel by means of one of the bolts that holds the frame for the glass window.

Fixed bias of approximately 100 volts is provided for the grid circuit of the amplifier from a separate supply. Extra bias for the stage is afforded by the added drop across resistor R₁. This resistor accomplishes the additional purpose of acting as an r-f choke to isolate r.f. from the bias lead.

Normal operating conditions for the amplifier on the bands from 3.5 through 28 Mc. are as follows: grid current, 8 ma.; plate voltage, 2000 (modulated for AM phone); screen voltage, 400 (fed through a series screen choke for plate modulation); plate current, 175 ma. for phone and 225 ma. max. for c.w. The amplifier runs quite cool and very stably under these operating conditions. Approximately 5 watts of grid driving power should be available to insure that adequate grid current can be obtained on all bands.

DE LUXE ONE-KILOWATT AMPLIFIER USING BEAM-TETRODE TUBES

The amplifier unit shown in Figures 23 and 24 is the final stage of the de luxe one-kilowatt transmitter described in Chapter 26. A pair of 4-250A tubes have been used in the amplifier in the transmitter shown in Chapter 26 since the final amplifier is plate modulated for radiotelephony. If the stage is to be used for c-w or FM work only, the 4-250A's may be replaced by a pair of 4-125A's. These smaller tubes are capable of a full kilowatt for c-w use but are rated at 760 watts maximum input for high-level plate modulation.

The amplifier stage is driven by a single 807 operating as an amplifier at a plate potential of 600 volts. Ample excitation is obtained on all bands from 3.5 through 29.7 Mc. A standard bandswitching turret assembly is used in the grid circuit of the amplifier tubes. The plate of the 807 is connected to one side of the grid circuit and a small balancing capacitor is connected to the other side to compensate for the plate-to-cathode capacitance of the 807. The complete circuit diagram of the amplifier is given in Chapter 26 along with the balance of the description of the de luxe one-kilowatt transmitter.

Screen voltage for the tubes is fed from a 600-volt power supply through a current-limiting resistor of 3000 ohms and the series screen choke for deriving screen-voltage modulation along with the modulation of the plate voltage of the stage. Normal screen voltage on the stage is about 400 volts with a screen current of 70 ma. The grid current is approximately 25 ma. with about 240 volts of bias on the grids. The operating plate voltage is 3000 and the plate current is 330 ma. The 4-250A tubes show no plate color at a full kilowatt input on all the bands for which the amplifier is designed.

Figure 23.

TOP VIEW OF THE DE LUXE KILOWATT FINAL.

The variable link and its driving mechanism cannot be seen in this photograph since the assembly is supported from the cabinet which houses the amplifier.

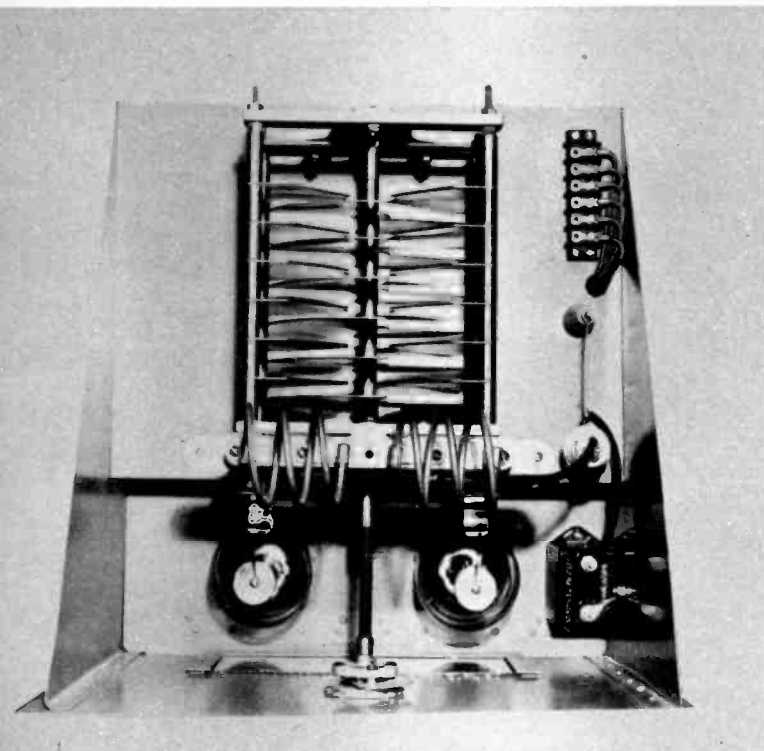
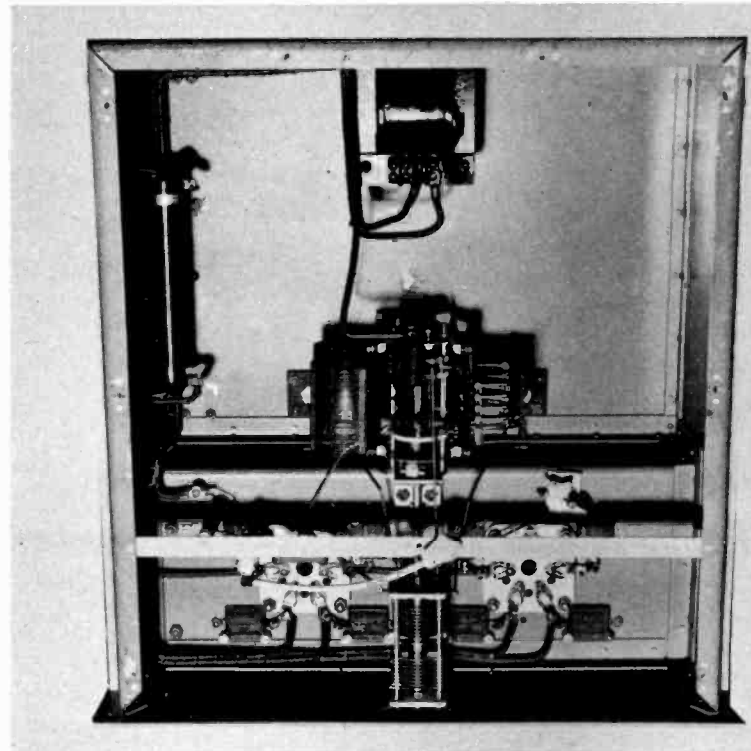

Figure 24.

UNDERCHASSIS VIEW OF THE BEAM-TETRODE FINAL.

The placement of components and the construction of the simple neutralizing capacitors can be seen in this photograph. The blower for cooling the bases and the plate seals of the tubes is mounted on the bottom cover of the amplifier chassis.



V-H-F and U-H-F Transmitters

AT THE present time there are allocated ten frequency bands for amateur use in the v-h-f and u-h-f frequency range (above 30 Mc.). These frequency bands are as follows: 50 to 54 Mc., 144 to 148 Mc., 235 to 240 Mc., 420 to 450 Mc., 1215 to 1295 Mc., 2300 to 2450 Mc., 3300 to 3500 Mc., 5650 to 5850 Mc., 10,000 to 10,500 Mc., and 21,000 to 22,000 Mc. It will be observed that the limits of these bands are not in harmonic relation as was the case with the pre-war amateur bands in the spectrum above 30 Mc. Equipment designed for use in these frequency ranges generally is quite different from apparatus for use at frequencies below 30 Mc. This chapter will deal with equipment for the 50 to 54 Mc., 144 to 148 Mc., 235 to 240 Mc., and 420 to 450 Mc. frequency ranges. No equipment for use on frequencies above 1000 Mc. is described since apparatus for these frequency ranges is very difficult mechanically to construct, almost invariably requiring the use of a lathe and other machine tools. Most of the amateurs operating on the

frequencies above 1000 Mc. are using converted surplus radar equipment in which the plumbing of the r-f circuits may be used substantially intact.

It is desirable to use m.o.p.a. or crystal-controlled operation on the v-h-f range, and wherever practicable on the u-h-f range above 300 Mc. However, great simplicity is obtainable in transmitters for frequencies above 144 Mc. by directly modulating the r-f power oscillator. But even in modulated oscillators some attempt is usually made to stabilize the oscillator through the use of a high-Q tank circuit as the frequency-controlling element.

60-WATT FM TRANSMITTER

Figures 1, 2, 3, and 4 show a 60-watt FM transmitter designed for narrow-band FM on the 10 and 11 meter bands and either narrow-band FM or medium band FM on the

Figure 1.
FRONT VIEW OF THE 60-
WATT FM TRANSMITTER IN
ITS HOUSING.

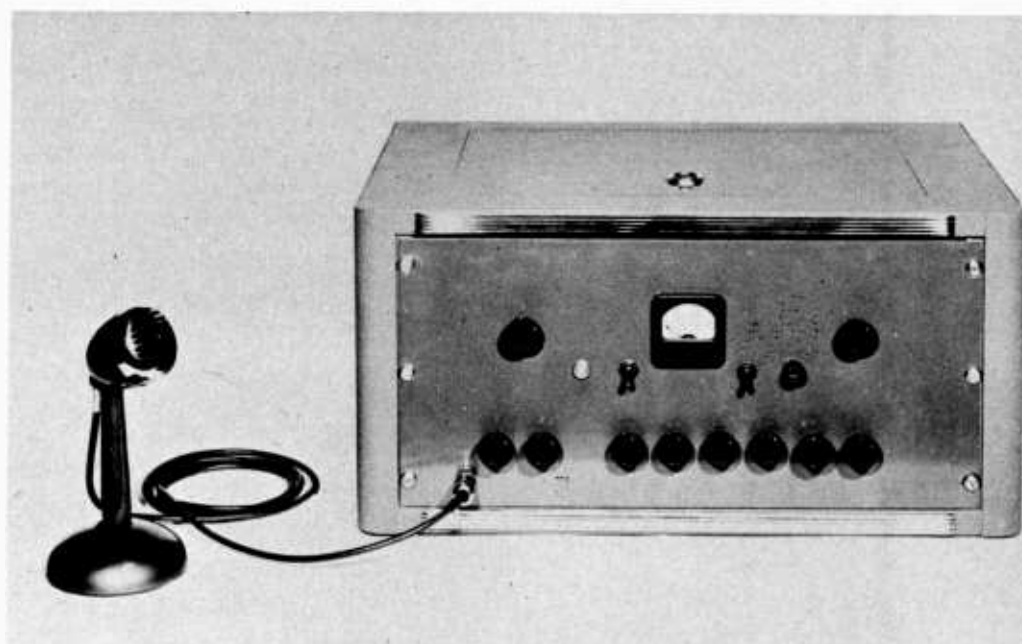

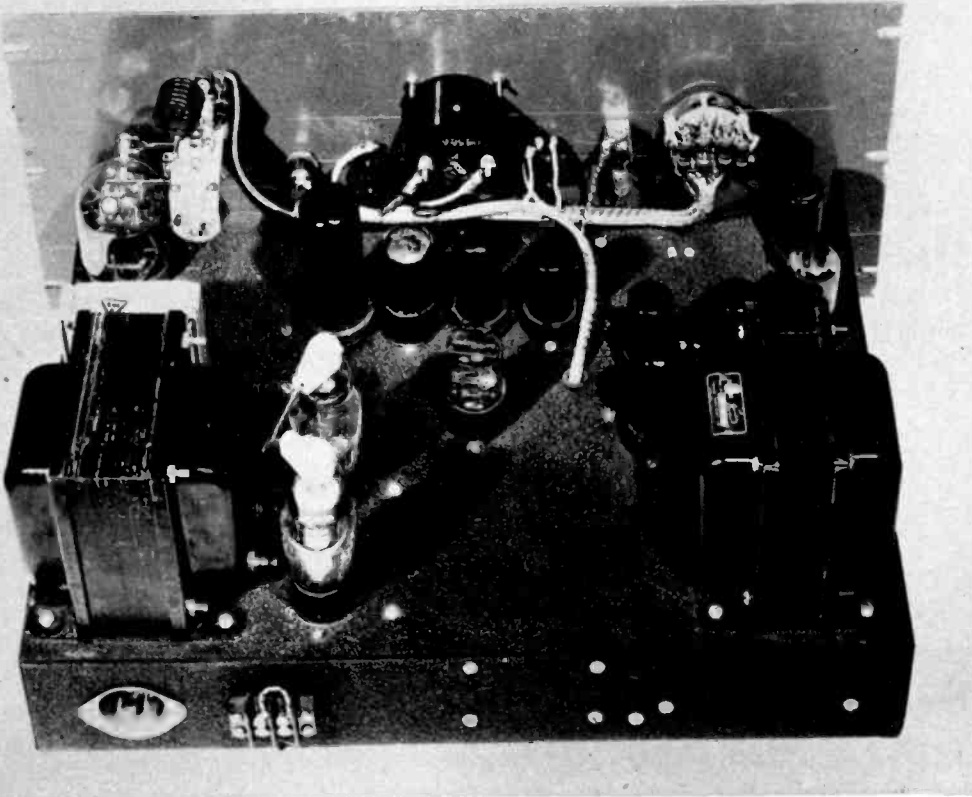

Figure 2.
REAR VIEW OF THE FM
TRANSMITTER.

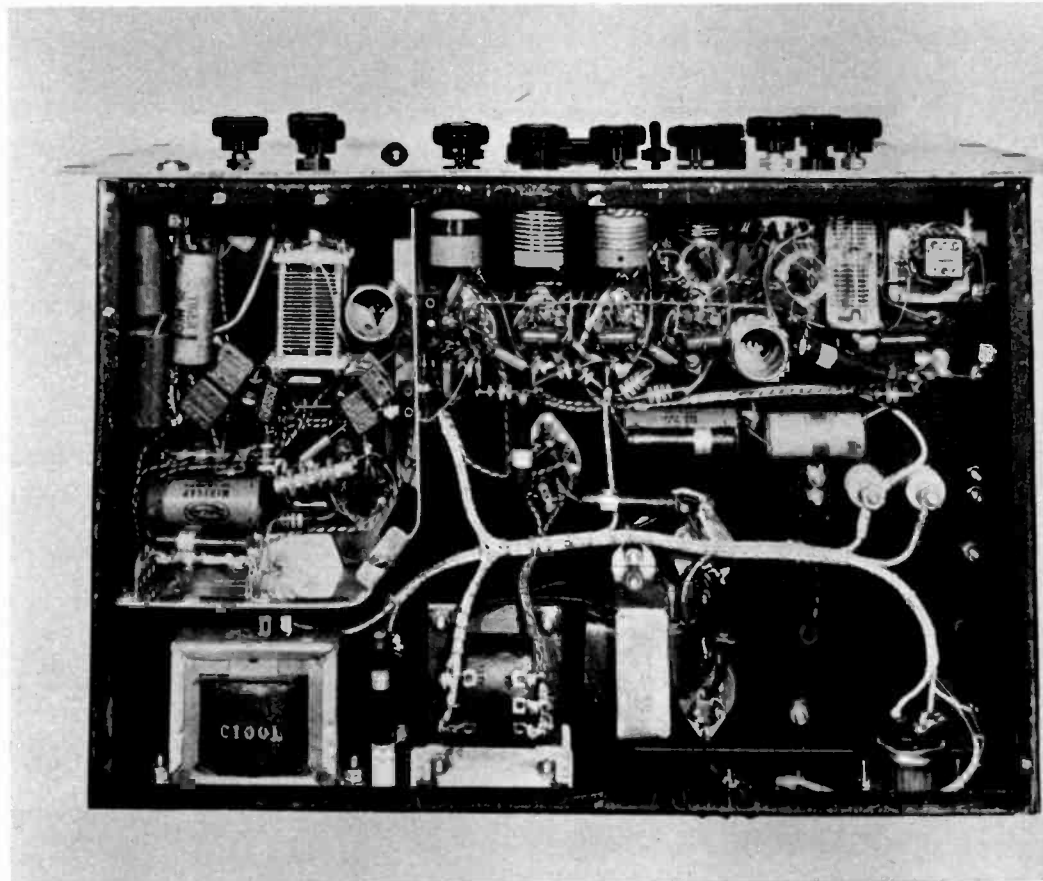

Figure 3.
UNDERCHASSIS VIEW OF THE
FM TRANSMITTER.

The phase modulator unit is isolated by the shield at one end of the chassis.

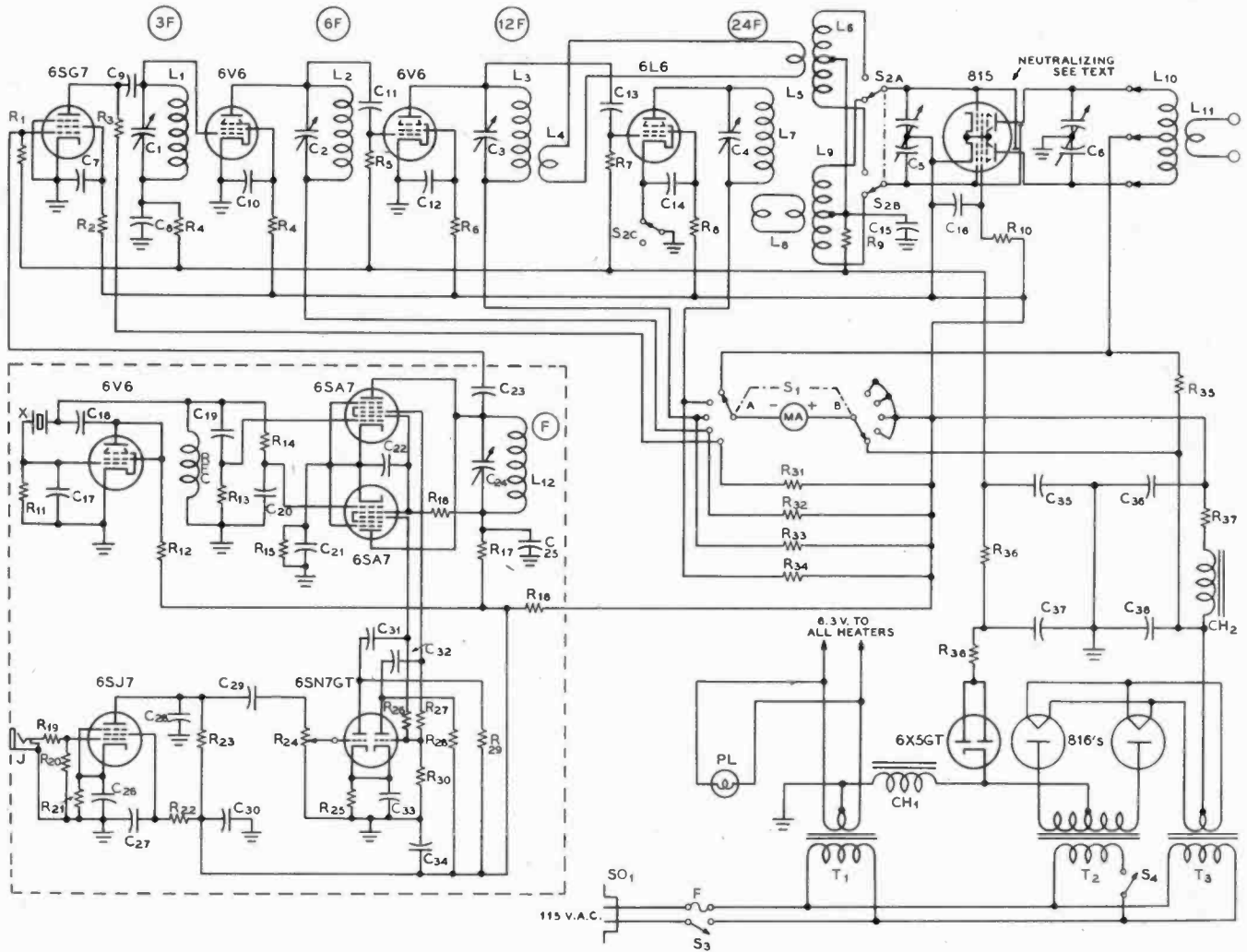

Figure 4.

SCHEMATIC OF THE 60-WATT FM TRANSMITTER.

- | | | | |
|--|---|--|---|
| <p>C₁, C₂—140-μfd. air-padder type with shaft
 C₃, C₄—75-μfd. air-padder type with shaft
 C₅, C₆—30-μfd. midget split stator
 C₇, C₈—0.003-μfd. midget mica
 C₉—50-μfd. midget mica
 C₁₀—0.003-μfd. midget mica
 C₁₁, C₁₂—50-μfd. midget mica
 C₁₃, C₁₄, C₁₅, C₁₆—0.003-μfd. mica
 C₁₇—50-μfd. midget mica
 C₁₈—0.003-μfd. midget mica
 C₁₉, C₂₀—75-μfd. midget mica
 C₂₁, C₂₂—0.003-μfd. midget mica
 C₂₃—50-μfd. midget mica</p> | <p>C₂₄—200 to 250 μfd. variable
 C₂₅—0.003-μfd. midget mica
 C₂₆—25-volt 25-μfd. elect.
 C₂₇—0.25-μfd. 400-volt tubular
 C₂₈—500-μfd. midget mica
 C₂₉—0.003-μfd. mica
 C₃₀—8-μfd. 450-volt elect.
 C₃₁, C₃₂—0.003-μfd. mica
 C₃₃—25-μfd. 25-volt elect.
 C₃₄—8-μfd. 450-volt elect.
 C₃₅—25-μfd. 150-volt elect.
 C₃₆—8-μfd. 500-volt elect.
 C₃₇—0.003-μfd. mica
 C₃₈—5-μfd. 600-volt oil
 R₁—100,000 ohms 1/2 watt
 R₂—100,000 ohms 2 watts
 R₃—22,000 ohms 2 watts
 R₄—Both 100,000 ohms 2 watts
 R₅—100,000 ohms 2 watts</p> | <p>R₆—39,000 ohms 2 watts
 R₇—100,000 ohms 2 watts
 R₈—39,000 ohms 2 watts
 R₉—12,000 ohms 2 watts
 R₁₀—10,000 ohms 10 watts
 R₁₁—47,000 ohms 1/2 watt
 R₁₂—22,000 ohms 2 watts
 R₁₃, R₁₄—470 ohms 2 watts
 R₁₅—100 ohms 2 watts
 R₁₆—10,000 ohms 10 watts
 R₁₇—100 ohms 2 watts
 R₁₈—10,000 ohms 10 watts
 R₁₉—100,000 ohms 1/2 watt
 R₂₀—470,000 ohms 1/2 watt
 R₂₁—1000 ohms 1/2 watt
 R₂₂—470,000 ohms 1/2 watt
 R₂₃—220,000 ohms 1/2 watt
 R₂₄—500,000-ohm potentiometer</p> | <p>R₂₅—1800 ohms 1/2 watt
 R₂₆, R₂₇—220,000 ohms 1/2 watt
 R₂₈, R₂₉—47,000 ohms 2 watts
 R₃₀—100,000 ohms 1/2 watt
 R₃₁, R₃₂, R₃₃, R₃₄, R₃₅—100 ohms 2 watts
 R₃₆—2000 ohms 10 watts
 R₃₇—500 ohms 10 watts
 R₃₈—1000 ohms 10 watts
 T₁—6.3-volt 6-ampere trans.
 T₂—1230 v. c.t. 250 ma.
 T₃—2.5-volt 5-ampere trans.
 CH₁—300-ma. swing choke
 CH₂—10.5 hy. 110-ma. choke
 S₁—2-pole 5-position meter sw.
 S₂—3-pole 2-position ceramic
 S₃, S₄—S.p.s.t. toggle sw.
 MA—0-200 d-c milliammeter
 Coils—See coil table</p> |
|--|---|--|---|

6-meter band. In addition, the unit may be used as an exciter for a high-power amplifier on either of these bands or as an exciter on the 144-Mc. band by tripling in the 815 stage. Coils are also provided for operation of the 815 stage as a tripler to the 78 to 80 Mc. range for feeding the grid circuit of another tripler to the 235 Mc. band.

Phase Modulator The portion of the unit shown enclosed within dashed lines in the schematic of Figure 4 and enclosed by means of a shield in the photograph of Figure 3 is essentially the same as the front end of the NBFM exciter described in Chapter 21. The unit is designed

for the use of a crystal in the vicinity of 2.2 Mc. for the 50 Mc. band, a crystal in the vicinity of 2.05 Mc. for the 144 Mc. band, a crystal in the vicinity of 2.2 for the 235 Mc. band, and a crystal from 3.4 to 3.7 Mc. for the 10 and 11 meter bands.

The operation of the phase modulator as used to obtain an FM signal is described in connection with the NBFM exciter in Chapter 21, and in somewhat more detail in Chapter 8 which is devoted to FM theory.

The Frequency Multiplier The frequency multiplication section of the transmitter is designed to deliver excitation to the grids of the final amplifier on either 8, 12

COIL TABLE	
60-Watt FM Transmitter	
L ₁	10 turns no. 20 enam. closewound 1" dia. form
L ₂	8 turns no. 20 enam. spaced to 3/4" on 1" dia. form
L ₃ , L ₄	5 turns no. 16 bare spaced wire dia. on 1" dia. form with 2-turn link hookup wire at cold end
L ₅ , L ₆	10 turns no. 16 bare spaced wire dia. on 1" dia. form, center tapped, 2-turn link hookup wire at center
L ₇	3 turns no. 18 tinned pre-wound coil with 2-turn link at cold end
L ₈	Link between L ₇ and L ₆
L ₉	6 turns no. 18 tinned pre-wound coil, center tapped, with 2-turn link of hookup wire at center
L ₁₀	28-Mc. Band—12 turns no. 14 enam. 1" dia. by 1 1/4" long, center tapped, air wound 50-Mc. Band—6 turns no. 12 enam. 3/4" dia. by 3/4" long, center tapped, air wound 80-Mc. (for tripling to 240-Mc. band)—4 turns no. 14 enam. 3/4" dia. by 3/4" long, c.t., air wound
L ₁₁	Link of one or two turns around L ₁₀ for each band

or 2-1 times the frequency of the crystal. For operation on the 6 and 2 meter bands the plate circuit of the 6SG7 multiplier is tuned to the vicinity of 6.6 Mc. The plate of the first 6V6 is tuned to approximately 13 Mc., the plate of the second 6V6 is tuned in the vicinity of 26 Mc. and the plate of the 6L6 is tuned to 48 to 54 Mc. The 815 then either runs straight through as an amplifier on the 6 meter band or can be used as a tripler to the 144 Mc. band.

For operation on the 1 1/4 meter band the grids of the 815 are excited from the tank in the plate circuit of the second 6V6 on about 26 Mc. and the 815 is used as a tripler to the 78 to 80 Mc. region. Excitation for the 815 is obtained either from the second 6V6 multiplier or from the 6L6 multiplier by moving switch S₂. The output of this stage is then used to excite the grids of another tripler, which might be the 829B amplifier-tripler described in this chapter, to deliver output on the 235-Mc. band.

On the 10 and 11 meter bands the 6SG7 is used as a doubler to the region of 7.4 Mc., the first 6V6 is tuned to 14.8 Mc., and the second 6V6 is tuned to the range from 27.16 Mc. to 29.7 Mc. The grid circuit of the 815 is switched to the plate circuit of the second 6V6 by S₂ for operation on this frequency range, and the 6L6 multiplier stage is not used.

Power Supply A pair of 816 mercury vapor rectifier tubes are used in the 400-volt 250-ma. power supply for the transmitter. A choke-input filter system with the choke in the negative lead is used. The ripple voltage across the input choke is rectified by means of a 6X5GT tube to provide about

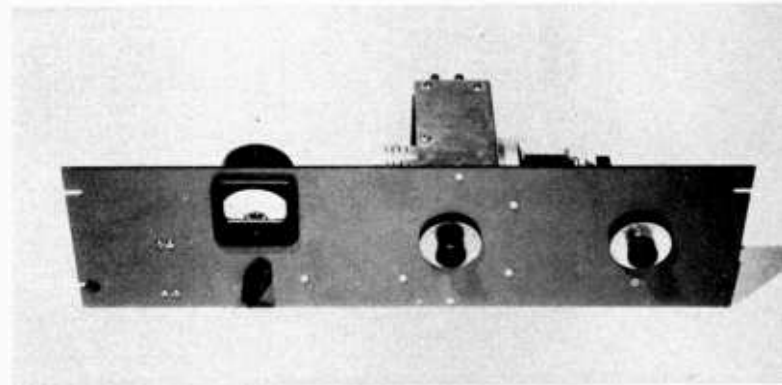

Figure 5.
829B AMPLIFIER-TRIPLER UNIT.
The front view of the unit shows the 0-500 d-c milliammeter and its meter switch, and the tuning capacitors for the grid and plate circuits.

60 volts of bias for the multiplier stages in the transmitter. Meter switching is used to measure the plate current of each of the high level stages in the transmitter. Normal operating current for the 815 final amplifier is from 125 to 150 ma.

829B AMPLIFIER-TRIPLER UNIT

The unit illustrated in Figures 5, 6, and 7 has been designed for operation on the 50 Mc., 144 Mc. and 235 Mc. bands with grid excitation derived from an external exciter unit. Without forced cooling on the envelope of the 829B the amplifier is capable of 120 watts input on 50 and 144 Mc. as an amplifier at a plate voltage of 500 to 750 volts. This rating is for operation as a straight c-w amplifier or for FM use. It is rated at 90 watts input maximum at 600 volts as a plate modulated amplifier on the 50 and 144 Mc. bands. The unit is capable of an input of approximately 50 watts at 500 volts as a tripler from 48 to 144 Mc. or for tripling from 80 to 240 Mc. From 2 to 4 watts of excitation power should be available for all types of operation, although somewhat less excitation may be used for c-w operation straight through as long as the plate dissipation of the tube is not exceeded.

With forced air draft on the envelope such as can be obtained with a small blower or fan, and with cooling radiators on the anode connections of the tube, the input may be run approximately 20% above the figures in the preceding paragraph. Either an 829B or 3E29 tube may be used in the amplifier. The type 3E29 tube is more generally available on the surplus market since this tube was used as a pulse amplifier

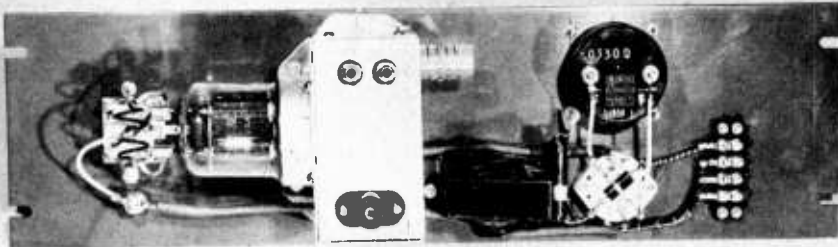

Figure 6.
REAR VIEW OF THE 829B UNIT.

The 144-Mc. plate coil is in place in the plate circuit and the 50-Mc. coil is in the grid circuit. The unit is set up in this manner for tripling from about 48 Mc. into the 144-Mc. band. The 50-Mc. and 235-Mc. plate coils can be seen below the plate end of the unit and the 144-Mc. and 80-Mc. grid coils are visible below the other end of the amplifier-tripler.

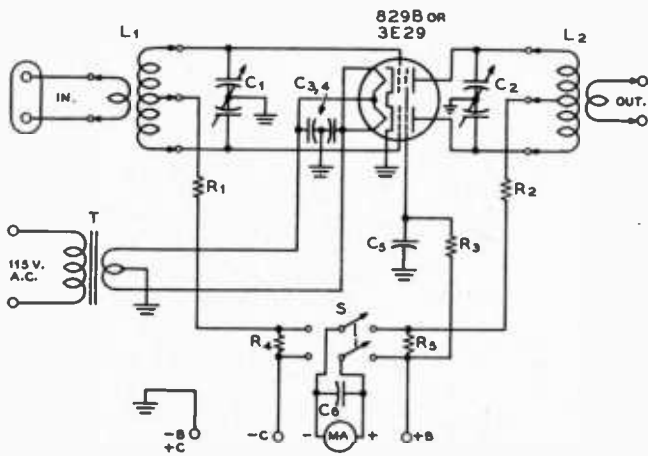

Figure 7.

SCHEMATIC OF THE 829B AMPLIFIER-TRIPLER UNIT.

- C₁—30- μ fd. per section midget split stator
- C₂—8- μ fd. per section midget butterfly
- C₃, C₄, C₅, C₆—0.002- μ fd. midget mica
- R₁—500 ohms 10 watts
- R₂—100 ohms 2 watts
- R₃—10,000 ohms 10 watts
- R₄—100 ohms 2 watts
- R₅—Shunt removed from milliammeter MA
- L₁, L₂—See rear-view photo
- T—6.3-volt 2.5-amp. transformer

in a number of low-power radar equipments. However, the internal construction of the 3E29 is substantially the same as the 829B.

The amplifier operates quite stably on all three of the bands mentioned with no necessity for neutralization as long as some antenna load is coupled to the output circuit. If a type 815 tube is substituted for the 829B, the input must be reduced to a maximum of 75 watts at 500 volts; satisfactory operation on the 235 Mc. band will probably not be obtainable.

Coil Coils for all bands are indicated in the accompanying coil table. A one-turn link is wound in the center of the grid coil for each of the three grid coils shown. Grid coils for the 50 and 80 Mc. regions are wound on Amphenol no. 24-5H coil forms. The grid coil for the 144 Mc. band is made by sawing off the top of one of these forms a distance about $\frac{1}{8}$ inch above the base. The coil itself is then made self-supporting from the prongs in the base of the coil form. Plate coils for all bands are self-supporting.

The plate inductor for the 235-Mc. band can be seen in the photograph of the unit in Figure 6. This inductor is constructed from a piece of 1/32-inch copper strip $\frac{3}{8}$ inch wide and 6 inches long bent into a "U" with $\frac{5}{8}$ inch between the sides. Fahnestock clips are soldered to the ends of the copper strip. The tuning capacitor mounted on the panel is not used on the

COIL TABLE

829B Amplifier/Tripler Stage

Grid coils

- 50 Mc.—5 $\frac{1}{2}$ turns c.t. no. 14 bare $\frac{3}{4}$ " dia. by $\frac{3}{4}$ " long, 1-turn link.
- 80 Mc.—3 $\frac{1}{4}$ turns c.t. no. 14 bare $\frac{3}{4}$ " dia. by $\frac{3}{4}$ " long, 1-turn link.
- 144 Mc.—2 turns c.t. no. 14 bare $\frac{1}{2}$ " dia. by $\frac{5}{8}$ " long, 1-turn link.

Plate coils

- 50 Mc.—10 turns c.t. no. 14 bare $\frac{3}{4}$ " dia. by 1 $\frac{1}{2}$ " long.
- 144 Mc.—3 turns c.t. no. 12 bare $\frac{1}{2}$ " dia. by 1-inch long.
- 235 Mc.—See text for description and photo for appearance.

235-Mc. band; rather, a trimming capacitor is mounted upon the copper strip. This capacitor consists of a 1-inch diameter circle of sheet copper soldered to the end of a 6-32 and threaded through a 6-32 nut which is soldered to one side of the strip. The output circuit is tuned to resonance on the 235 Mc. band by rotating the 6-32 screw with a plastic neutralizing screwdriver to adjust the spacing between the copper disk and opposite side of the plate inductor. After proper adjustment has been obtained the movable disk is fixed in position by means of a locking nut on the 6-32 screw.

Meter Circuit Metering of the plate current and grid current of the amplifier-tripler unit is obtained through the use of a Simpson 127 0-500 d-c milliammeter with the aid of a meter switch. The shunt is removed from the inside of the meter and soldered across the plate circuit contacts on the meter switch. In the grid current position a 100-ohm resistor is soldered across the contacts of the switch. Full scale in the grid current position will be approximately 30 ma. In the plate coil position full scale is the normal value of the milliammeter or 500 ma. Hence for normal operation of the amplifier both grid current and plate current should come approximately to one-half scale on the indicating instrument.

24G/3C24 AMPLIFIER FOR 6 AND 2 METERS

The 24G/3C24 amplifier unit is illustrated in the photographs of Figures 8 and 9. It was designed primarily for operation on the 6 and 2 meter bands; but both the grid and plate tank capacitors are large enough for operation on frequencies as low as 14 Mc. if appropriate coils are used. Operation on the 40 and 80 meter bands is possible if a small padder capacitor is placed across the tank capacitor for these bands. The unit has given satisfactory results when operated with 200 watts input at 1250 volts on both the 50-Mc. and 144-Mc. bands. Normal grid current is 30 to 40 ma. with 125 volts of bias. Adequate driving power has been obtained from an 807 doubler to the 50 Mc. band with 450 volts on the plate of the

Figure 8. LOOKING DOWN ON THE PUSH-PULL 24G/3C24 AMPLIFIER.

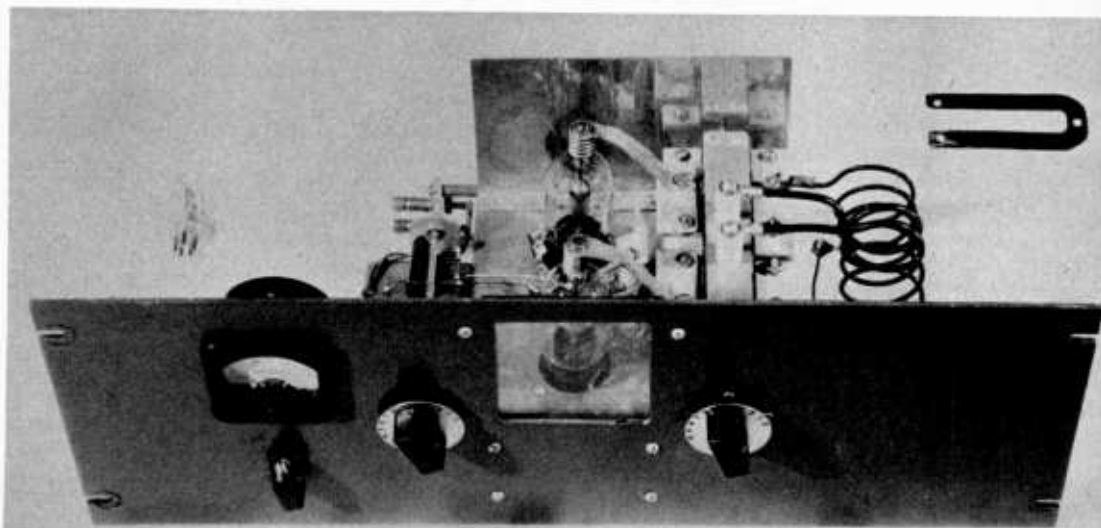

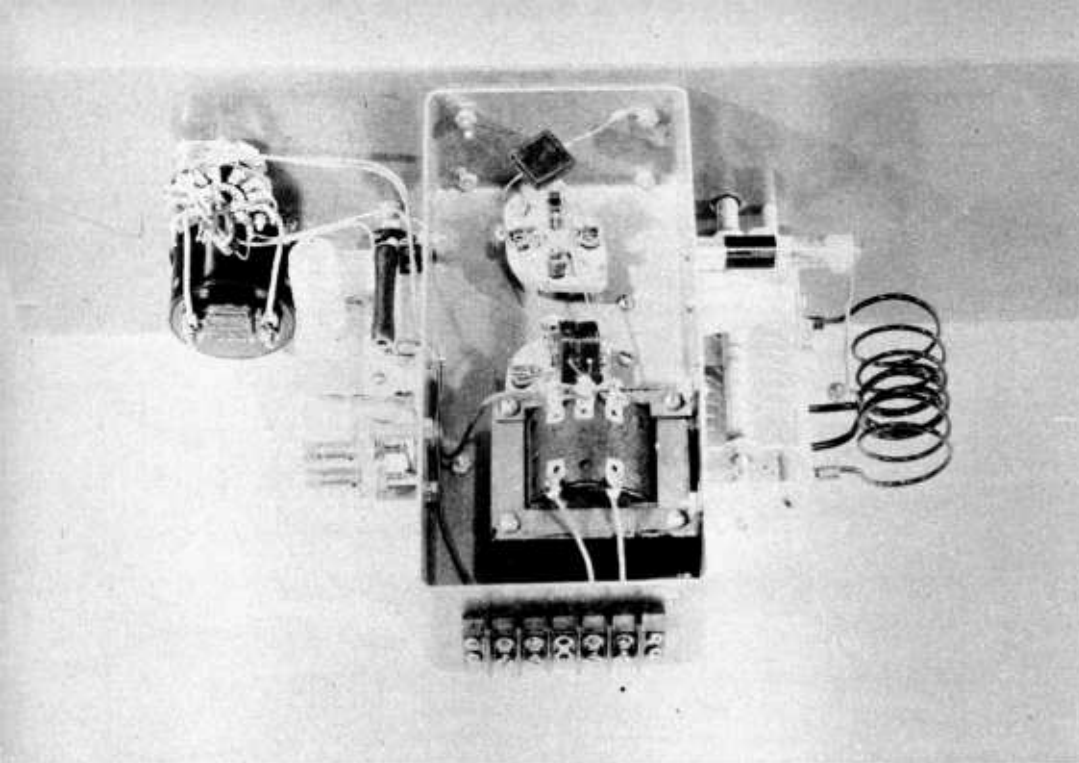

Figure 9.
UNDERCHASSIS VIEW OF THE
24G/3C24 AMPLIFIER.

Since this photograph was taken the leads from the filament bypass capacitors to ground have been run to the chassis of the unit with the shortest possible connections. The operation on the 144-Mc. band was improved materially by this change in leads.

807. Excitation for operation on the 144 Mc. band can be obtained from an 829B or 815 tripler with 400 volts on the plate of either tube. Eight to 10 watts of driving power should be available for exciting the amplifier.

Tuning Circuits Split-stator tuning capacitors with rotors grounded are used in both the grid and plate circuits of the amplifier. The grid tank capacitor is a Hammarlund HFD-30X and the plate tank capacitor is a Cardwell NP-50-DD. The grid circuit coils are wound on Amphenol 24-5H coil forms and the same coils are used in the grid circuit of this amplifier as are used in the grid circuit of the 829B amplifier/tripler just described. The plate tank inductors for the 6 and 2 meter bands are self-supporting. The 50 Mc. coil consists of 6 turns of no. 10 enamelled wire 1½ inches in diameter and 3 inches long. A 2-turn link of the same wire with spaghetti tubing covering it is used for antenna coupling on the 6-meter band. The 144-Mc. plate inductor is cut from a sheet of 1/16-inch copper and is 3½ inches long by 1½ inches wide with a 9/16-inch slot cut down the center. This inductor may be seen behind the amplifier in the photograph of Figure 8.

Neutralizing Capacitors The two neutralizing capacitors for cross neutralization of the two tubes are made in the following manner: Two strips of 1/16-inch aluminum, 1½ inches wide and 2¼ inches long are bent so that 1½ inches of each strip extends downward from the plate tank capacitor. The horizontal portion of these two strips is mounted by means of the two bolts for each stator section of the plate tank capacitor, as can be seen in Figure 8. The small neutralizing plates that are connected to the grids are mounted on 1-inch cylindrical ceramic standoff insulators and are cut from 1/16-inch aluminum strip ¾-inch wide. The strips themselves are bent so that 1 inch of each strip extends upward from the mounting insulator. Neutralization of the stage is obtained when the two adjacent plates of each neutralizing capacitor are spaced approximately ¼ inch from each other. The amplifier may be neutralized on the 144 Mc. band and neutralization will hold over the other bands. It is important that the shortest possible leads between the filament terminal of each socket and ground be employed. One-half inch flexible braid is run from the plate connectors of the tubes to the plate tank tuning capacitor. One-quarter inch flexible braid is run from the grids of the two tubes to the bus

bar running from each neutralizing capacitor to the grid tuning capacitor.

It was found necessary to mount an aluminum balancing plate on the rear of the chassis approximately the same distance from the rear tube as the panel of the unit is spaced from the front tube. The plate shown in the photographs is 3¾ inches high and 6¼ inches long. The rear of the plate tuning capacitor is bolted to this plate in the same manner that the front of the plate capacitor is bolted to the panel. Before this plate was installed the unbalanced capacitance to ground from the two tubes caused them to load unevenly on the 144-Mc. band. A 0-300 d-c milliammeter in conjunction with a meter switch is used to measure either the grid current or the cathode current of both tubes simultaneously. The plate circuit radio frequency choke is installed on a ½-inch diameter polystyrene standoff insulator 2½ inches long. This choke consists of 15 turns of no. 22 enamelled wire spaced to 1½ inches followed by a space of ¼ inch and then followed by ¾ inch of close-wound no. 22 enamelled wire.

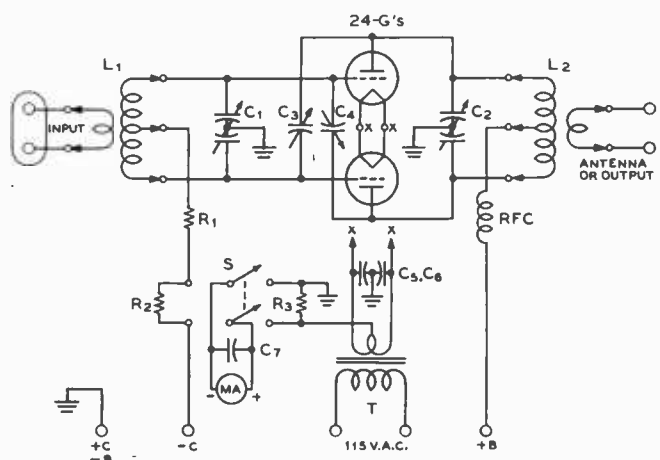
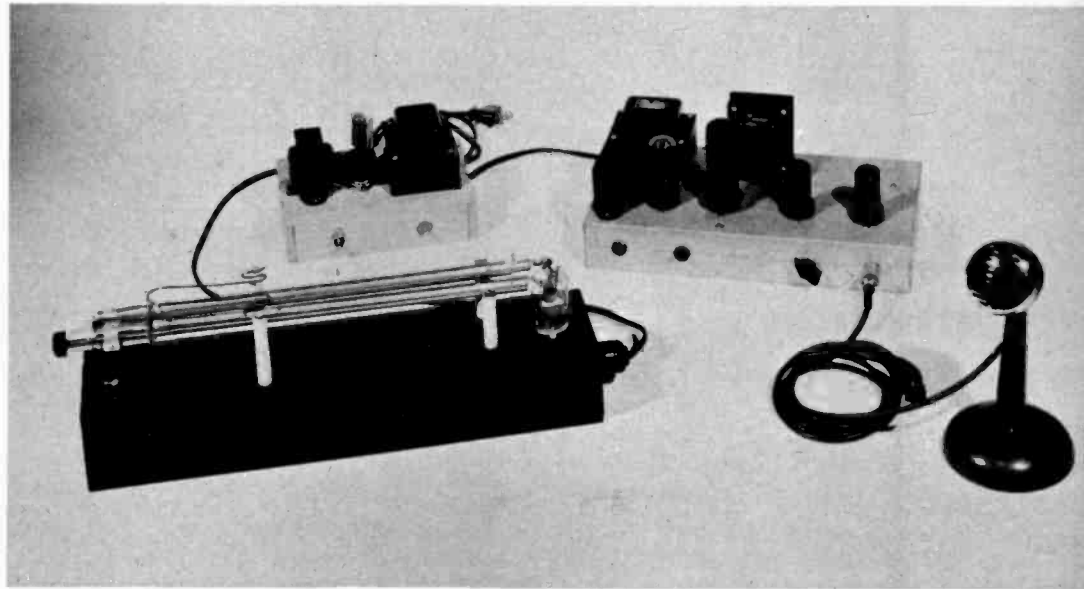

Figure 10.
SCHEMATIC DIAGRAM OF THE 3C24/24G
AMPLIFIER.

C₁—30-μfd. per section
C₂—50-μfd. per section
C₃, C₄—Neut. cap. See text
C₅, C₆—0.0025-μfd. midget mica
C₇—0.003-μfd. midget mica
R₁—1000-ohm 10-watt wire-wound
R₂, R₃—100 ohms 2 watts
MA—0-300 d-c milliammeter
T—6.3 volts, 6 amperes
RFC—See text
Coils—See text

Figure 11.
LINE-STABILIZED TRANSMITTER FOR 144 and 235 MC.

A kit-form v-h-f oscillator is used in conjunction with the 8-watt audio amplifier to make up a convenient low-power v-h-f transmitter.



SELF-EXCITED TRANSMITTER FOR 144 AND 235 MC.

Figure 11 shows a relatively simple combination of units which may be grouped to provide a transmitter of approximately 10 watts output on the 144 and 235 Mc. bands. The r-f portion of the transmitter is a line-stabilized oscillator, which is available as a kit or a manufactured unit, using a HY-75A tube. The modulator is the single-6L6 amplifier described in Chapter 24 with the output transformer removed and replaced by a 10-watt modulation transformer. This amplifier when used as a modulator is capable of modulating an input of 18 to 20 watts to the r-f stage. The plate voltage on the HY-75A oscillator is 400 volts and the antenna coupling is adjusted until the oscillator tube draws 50 ma. of plate current.

By proper adjustment of the plate lines on the oscillator it is possible to use the transmitter either on the 144-Mc. band or on the 235-Mc. band. The transmitter will hit the 144-Mc. band with nearly all the parallel-rod line in the circuit, and it hits the 235-Mc. band with the rod length reduced to approximately 5 inches. Adjustment of the frequency of transmission can best be made with the aid of a pair of lecher wires using the table of wavelengths given in Chapter 29 as a guide. Accurate frequency checking can be done with the aid of the harmonics of a lower-frequency transmitter whose output frequency is known. The harmonics of the low-frequency transmitter may be used to calibrate the v-h-f receiver, and the frequency of the v-h-f transmitter may then be checked by the calibration on the v-h-f receiver. The lecher wires should be used first, however, to determine the approximate frequency of the transmitter.

PUSH-PULL 257B/4E27/8001 HIGH-POWER AMPLIFIER

The amplifier shown in Figures 12 and 13 was constructed for operation in the five lowest frequency amateur bands, with 600 watts input for c-w operation or 500 watts plate modula-

tion. An output of approximately 75 watts' can be obtained with suppressor modulation. Using type HK-257B pentodes, the grid drive requirements are extremely low. Alternate designations for the same tube type are 4E27 and 8001.

The cabinet is constructed entirely of 20 gauge sheet metal, and is 17" x 17" x 11". The front and side section is bent from one sheet and joined to the top, bottom, and chassis by 8-32 bolts and 1/4" square aluminum stock. The chassis is 17" x 11" x 3", with a small opening at the rear to accommodate the plug-in type grid coil.

Five-band operation is accomplished through the use of a

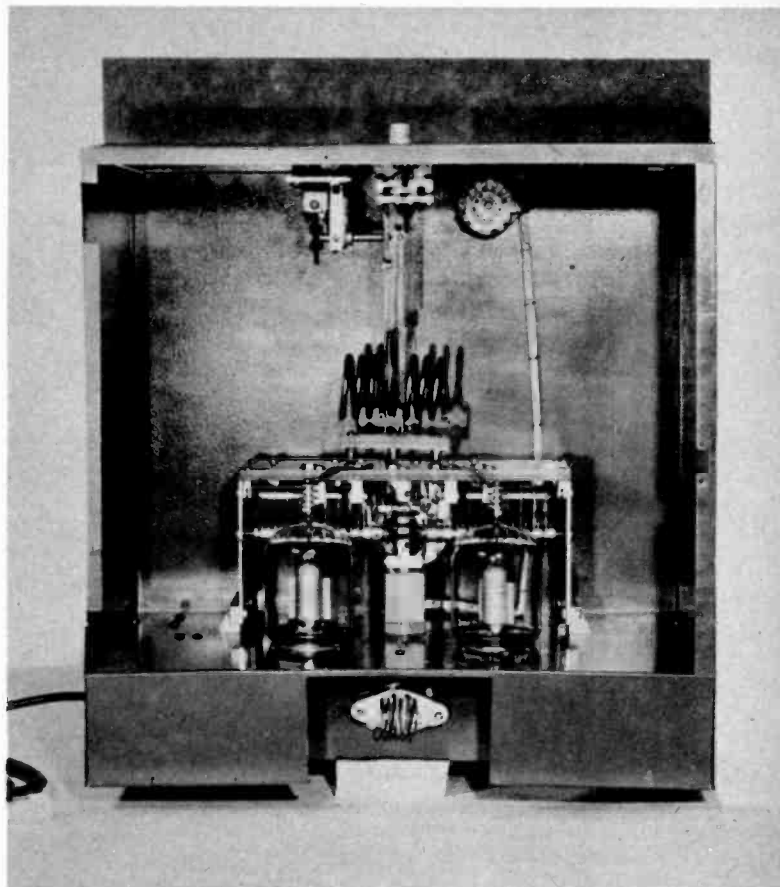

Figure 12.

REAR VIEW OF THE HK-257B AMPLIFIER.

Note the center-drive four-section, split-stator tuning capacitor and the worm-drive mechanism for the variable antenna-coupling loop. The coils for the 50-Mc. band were in place when this photograph was taken.

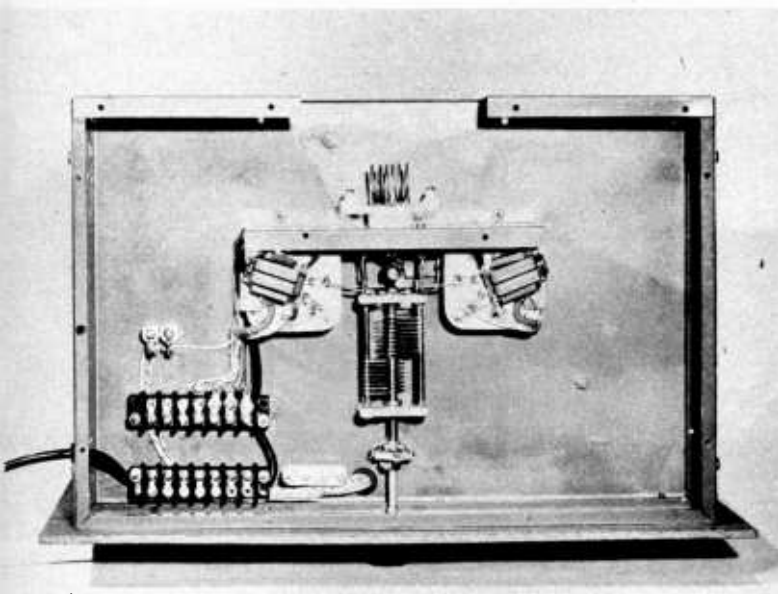

Figure 13.
UNDERCHASSIS VIEW OF THE H-F OR V-H-F POWER AMPLIFIER.

specially constructed plate tank capacitor with four isolated stator sections. The low-capacitance section (2 stators-3 rotors) is used on 10 and 6, with all sections required for the lower frequency bands.

Inspection of the photos and the circuit schematic will reveal how the correct stator connections are made by modification of manufactured 80, 40, and 20 meter coils, and home constructed 10 and 6 meter coils. The necessary changes for B & W type TVL coils involve removing the two separate

center-tap connections and soldering them to a banana plug added at the center of the ceramic plug-bar. Two shorting bars are then added between ends of the coil and adjacent plugs.

The plate tank capacitor is assembled from parts of two standard 85- μ fd. transmitting variables with a plate spacing of approximately 0.135 inches. The insulating plate is constructed of two layers of 3/16" polystyrene stock for strength. The addition of stator support pillars, rotor shaft with right angle drive, and end-plates of appropriate height forms a capacitor with which it is possible to maintain optimum LC ratios over a wide range of frequencies.

Wiring of this amplifier is conventional in most respects, except for the practice of by-passing each of the dual terminations of the screen and suppressor grids at the socket. The internal lead inductance of these elements can be appreciable in the v-h-f range, hence adequate by-passing, short leads, and a good ground are necessary to insure stable operation. The good ground is obtained by grounding one side of the filament of each tube and the center-tap of the 10-volt filament transformer at a common point at each socket. The metal base of each tube is grounded by spring steel wiping contacts.

A switch is provided to measure either control-grid or screen-grid current with one 0-25 d-c milliammeter. The shunt in the screen lead should be constructed to multiply the meter reading by ten to give an adequate range for a variety of operating conditions. Provision is made for connecting external meters, though space is available to mount them on the panel if desired.

The control circuit to limit the screen voltage in the case of excitation keying, or excitation failure, is external and uses an 807 tube. Either suppressor-grid or plate-and-screen modulation of the tubes may be used. An appropriate value of screen dropping resistor should be used for the plate voltage in use on the stage.

The excitation requirements for the stage are very low, only about 0.5 watts of driving power being required for 500 watts input, plate modulated, at a plate potential of 2000 volts. Approximately twice this value of driving power is required

- C₁—100- μ fd. per section balanced-rotor split-stator capacitor
- C₂—Special four-stator tuning capacitor, see text
- C₃, C₄, C₅, C₆—0.003- μ fd. midget mica
- C₇, C₈, C₉, C₁₀—0.002- μ fd. 1250-volt working transmitting micas
- C₁₁, C₁₂—0.003- μ fd. midget mica
- C₁₃—0.001- μ fd. 5000-volt working transmitting type mica
- C₁₄—0.003- μ fd. midget mica
- R₁—10,000 ohms 10 watts
- R₂—100 ohms 2 watts
- R₃—Shunt for measuring screen current
- R₄—25,000 ohms 10 watts; may be eliminated if capacitance of C₁₃ is desired across secondary of mod. trans.
- R₅—Screen resistor determined by type of service. Approx. 75,000 ohms for plate modulation.
- RFC₁—2.5-mh. 125-ma. choke
- RFC₂—0.5-mh. 500-ma. choke
- M₁—0-25 d-c milliammeter (external)
- M₂—0-500 d-c milliammeter (external)
- RY—D.p.d.t. ceramic change-over relay
- T—10 v. 8 a. filament transformer (10 volts used for series tubes)

Figure 14.
SCHEMATIC DIAGRAM OF THE 500-WATT AMPLIFIER.

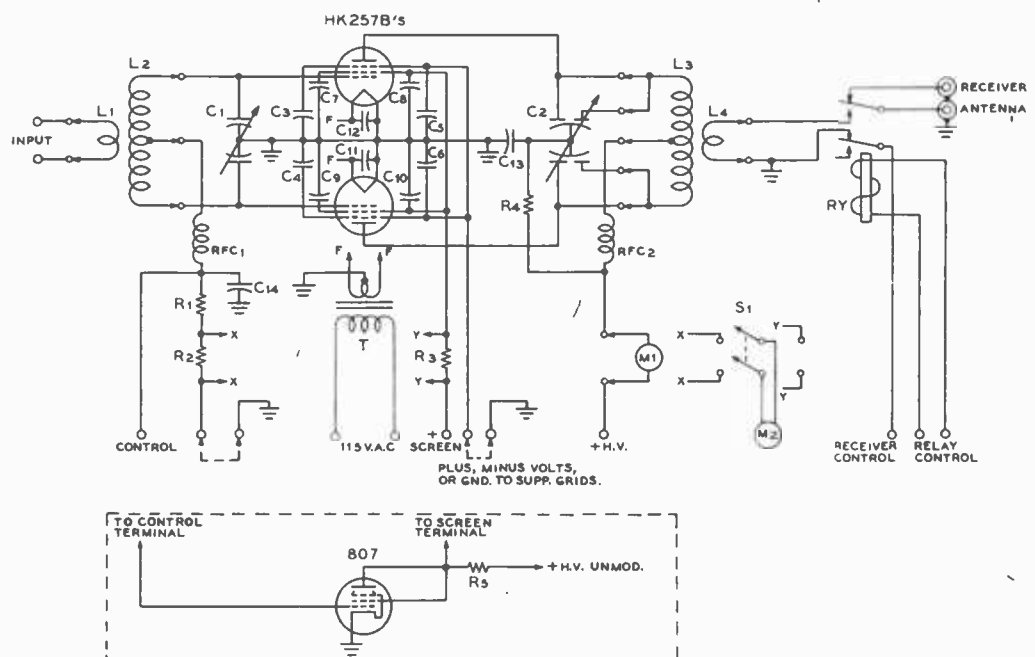
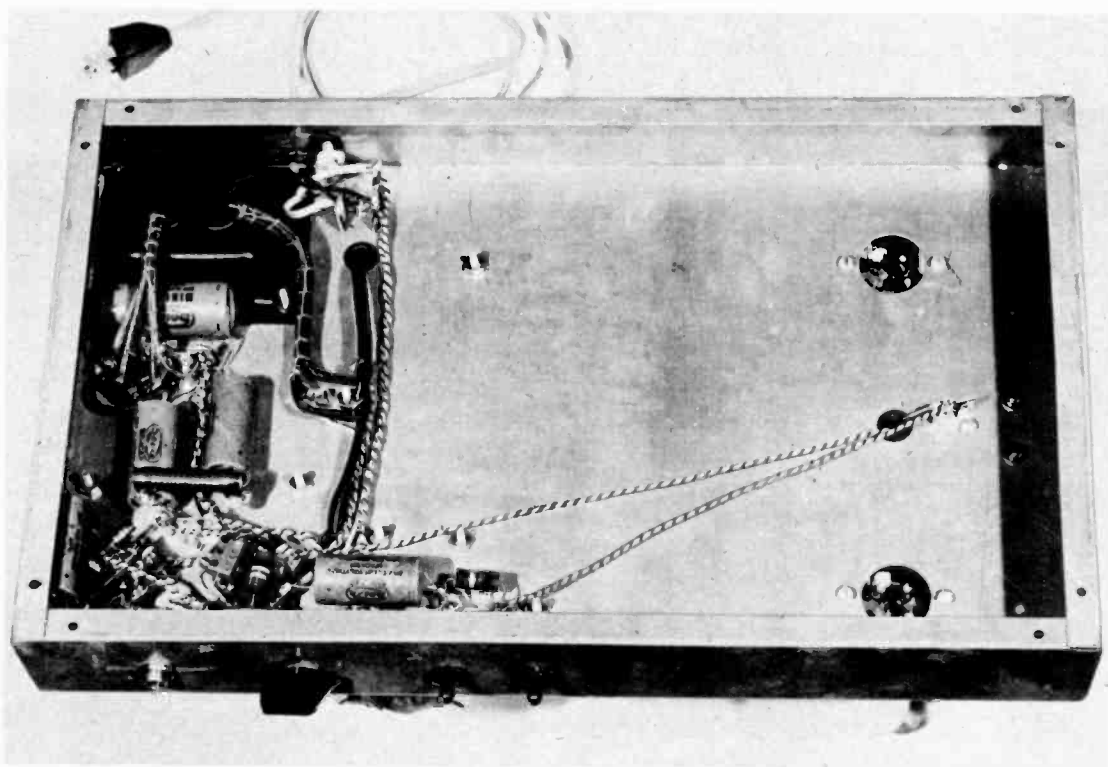
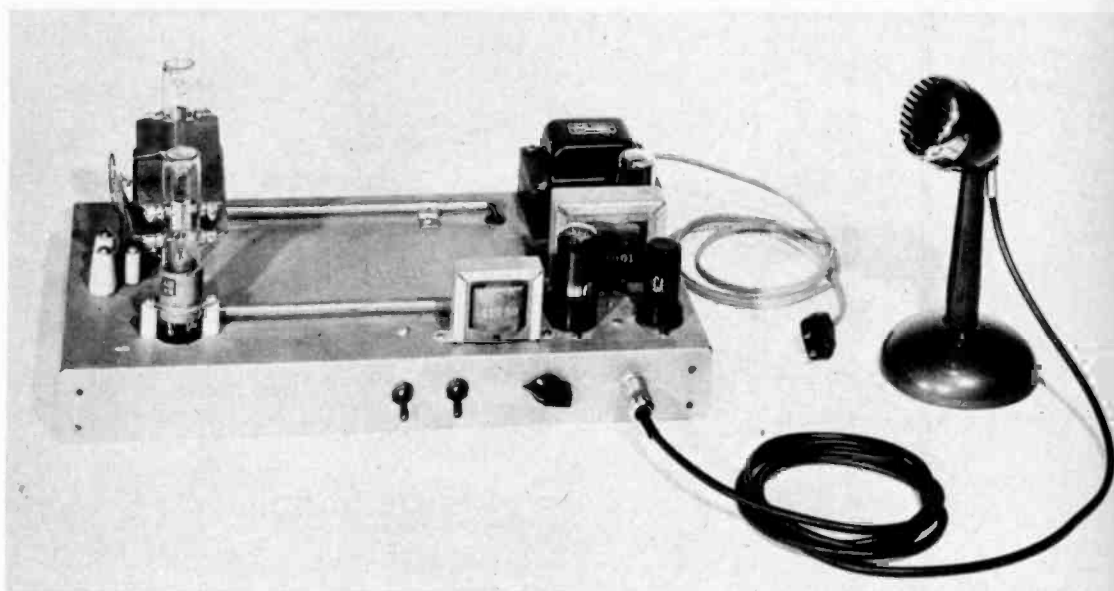

Figure 15.
FRONT VIEW OF THE 425-MC. TRANSMITTER.

The parallel-strip resonant tank circuit can be seen mounted between the two tubes. The filament lines, with their grounding straps, can be seen extending from the bases of the tubes toward the right-hand end of the chassis.

Figure 16.
UNDERCHASSIS VIEW OF THE 425-MC. TRANSMITTER.

The power supply and the audio amplifier portion of the transmitter are grouped toward one end of the chassis.



for suppressor-grid modulation of the stage. The maximum permissible plate current to the stage is 270 ma. for plate modulation and 300 ma. for c-w operation. The suppressor terminal of the amplifier may be grounded, but a slight decrease in the excitation requirements will be obtained if the suppressors of the tubes are operated at a positive potential of 60 volts. The operating value of screen voltage on the tubes should be limited to 750 volts for c-w use, to 600 volts for plate modulation, and to 600 volts fed through a 2000-ohm dropping resistor for suppressor-grid modulation.

8025/8025A 425-MC. TRANSMITTER

Through the use of the 8025A type of tube it is possible to obtain quite respectable amounts of power in the 420-Mc. amateur band. The unit shown in Figures 15 and 16 operates

with 300 volts at approximately 100 ma. on the plates of the tubes. Either type 8025 or 8025A tubes may be used. Although the particular arrangement shown uses only 300 volts on the tubes, the maximum ratings for a circuit such as shown are 800 volts at 130 ma. on the pair of tubes, or approximately 100 watts input. With this amount of input the air stream from an 8-inch fan should be directed against the envelopes of the tubes. However, with a plate power input of less than 65 watts to the oscillator, fixed air cooling is not required by the specifications of the tube manufacturer.

Oscillator Tank Circuit The parallel plate oscillator tank circuit, as can be seen from the photographs and the drawing, is quite unusual. The circuit actually consists of a parallel plate push-pull oscillator with the equiva-

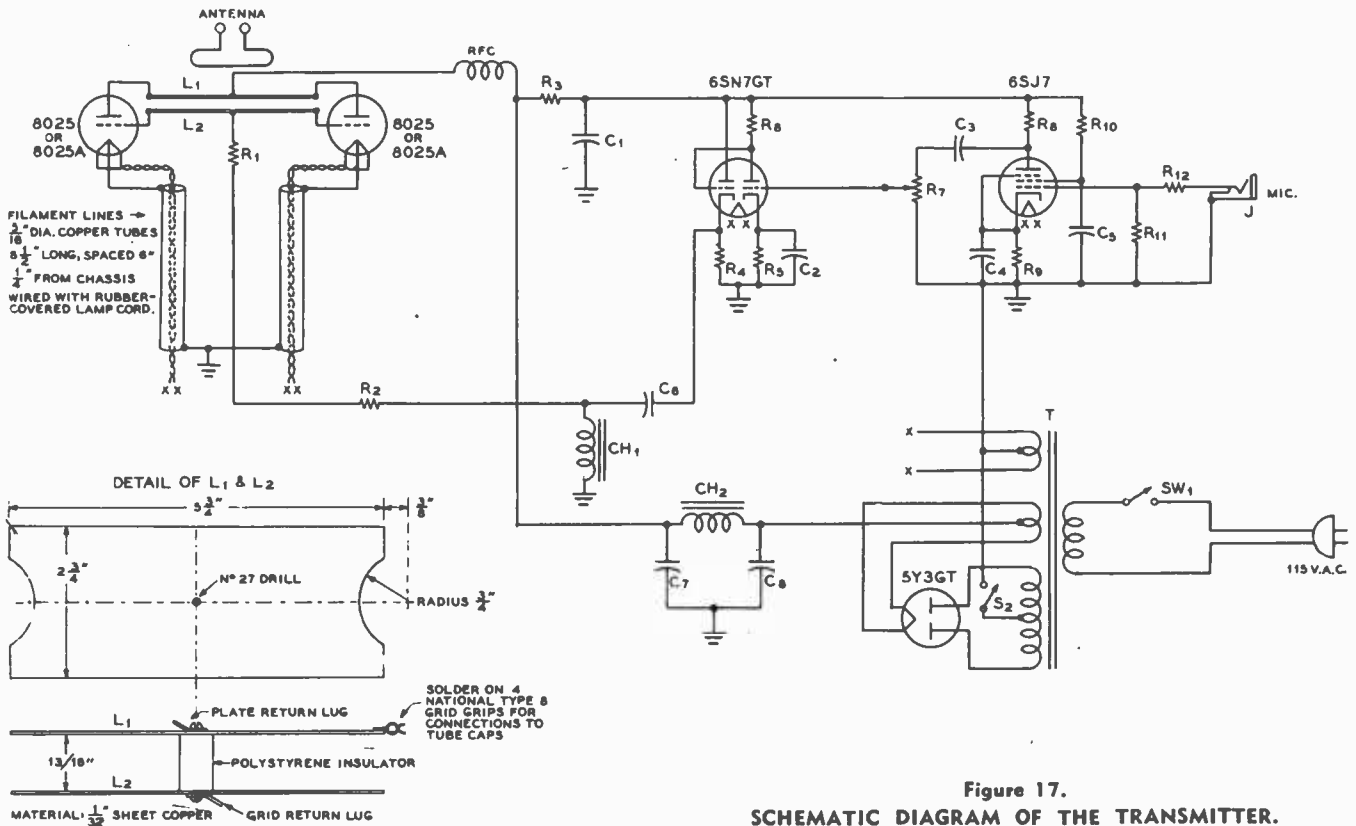

Figure 17. SCHEMATIC DIAGRAM OF THE TRANSMITTER.

- | | | | |
|--|---------------------------------------|---|---|
| C ₁ —8-μfd. 450-volt elect. | R ₁ —100 ohms 2 watts | R ₇ —500,000-ohm potentiometer | T—700 v. c.t. 120 ma., .5 v. 3 a., 6.3 v. 4.7 amperes |
| C ₂ —25-μfd. 25-volt elect. | R ₂ —1000 ohms 2 watts | R ₈ —470,000 ohms 1/2 watt | CH ₁ —13 henrys at 65 ma. |
| C ₃ —0.0025-μfd. midget mica | R ₃ —10,000 ohms 10 watts | R ₉ —1000 ohms 1/2 watt | CH ₂ —10.5 henrys at 110 ma. |
| C ₄ —25-μfd. 25-volt elect. | R ₄ —22,000 ohms 2 watts | R ₁₀ —1.0 megohm 1/2 watt | SW ₁ —S.p.s.t. a-c line switch |
| C ₅ —0.1-μfd. 400-volt tubular | R ₅ —3300 ohms 2 watts | R ₁₁ —1.0 megohm 1/2 watt | S ₂ —S.p.s.t. plate voltage sw. |
| C ₆ , C ₇ , C ₈ —8-μfd. 450-volt elect. | R ₆ —100,000 ohms 1/2 watt | R ₁₂ —47,000 ohms 1/2 watt | |

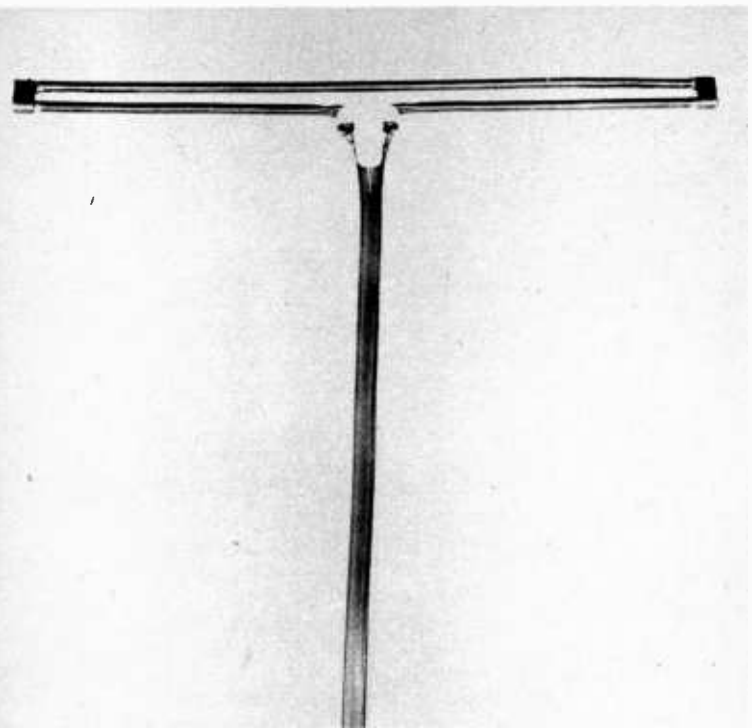

Figure 18. SIMPLE FOLDED-DIPOLE ANTENNA FOR THE 420-MC. BAND.

lent of half-wave lines between the grids and plates of the tubes. The dimensions shown in the drawing of Figure 17 should be followed quite closely to hit the center of the amateur band. Frequency changes within the band may be obtained by varying the spacing between the centers of the two parallel plates. This variation can be accomplished by cutting down the length of the polystyrene spacer for an increase in frequency or by adding additional spacing washers to the length of the insulator for a decrease in frequency.

To assemble the tank circuit the tubes are first mounted in their sockets and their four grid grips are attached to the grids of the tubes. Then the lower plate is soldered in place to the grid grips of the tubes. After the assembly has cooled, four more grips are clipped onto the plate caps of the tubes and the top plate is soldered in place. Note that the tube sockets are mounted on ceramic spacers about one inch above the chassis of the equipment. This expedient was found to be necessary to reduce dielectric loss in the sockets and the base of the tubes since the filament terminals of the tubes at the socket are not at r-f ground potential.

Frequency Checking The frequency of operation of the oscillator can be checked approximately by means of Lecher wires. With a pair of no. 16 Lecher wires spaced about 1/4 inches and a frequency of oscillation of approximately 425 Mc., the successive resonances on the wires will be obtained at 13 1/4 inches spacing. An accurate check on the frequency may be obtained with a precision wavemeter such as has been available on the surplus market. If such an instrument is not available and it is desired to know the oscillator

frequency quite accurately, a check may be obtained after the approximate frequency has been determined by listening to the harmonics of a 2-meter crystal controlled transmitter in a 420-Mc. receiver. If the 2-meter transmitter is operating on 144-Mc. the harmonic in the 420-Mc. receiver will come at 432 Mc. Adjustment of the frequency of the 420-Mc. oscillator so that it will beat with a harmonic of the 2-meter transmitter will give accurate knowledge of the transmitting frequency of the 8025 oscillator.

The use of the filament lines as shown in the photographs and drawing is required for satisfactory operation of the oscillator. Adjustment of these lines is fairly critical if maximum output is to be obtained. A method of adjustment is to couple the output of the oscillator to a lamp bulb for a load and then to adjust the strap which shorts the filament lines to the chassis until maximum output is obtained.

A 420-Mc. Antenna A simple folded dipole antenna for the 420-Mc. band is shown in Figure 18. The dipole itself is $13\frac{1}{4}$ inches long and is constructed of $3/16$ inch copper tubing. The method of construction can be determined from the photograph. The dipole may be fed by means of a short length of 300-ohm twinlead transmission line. Long lengths of feed line should not be used due to the high attenuation of this type of transmission line on the 420-Mc. band. The dipole may be used as the entire radiating system or it may be used in conjunction with a reflector and director each spaced about 0.2 wavelength from the driven element. Also the dipole may be used at the center of a corner reflector as described in Chapter 29.

The Modulator Grid-bias modulation of the oscillator has been used in this transmitter to provide frequency modulation. The output of the transmitter can be received with excellent quality on a wide-band FM receiver or on a superregenerative receiver. When this transmission is received with an AM receiver, best reception will be obtained with the receiver detuned slightly to one side of the transmitter frequency. The speech system is quite simple and is designed for operation from a crystal microphone. One half of the 6SN7 tube is used as a cathode follower to provide grid-bias modulation of the oscillator.

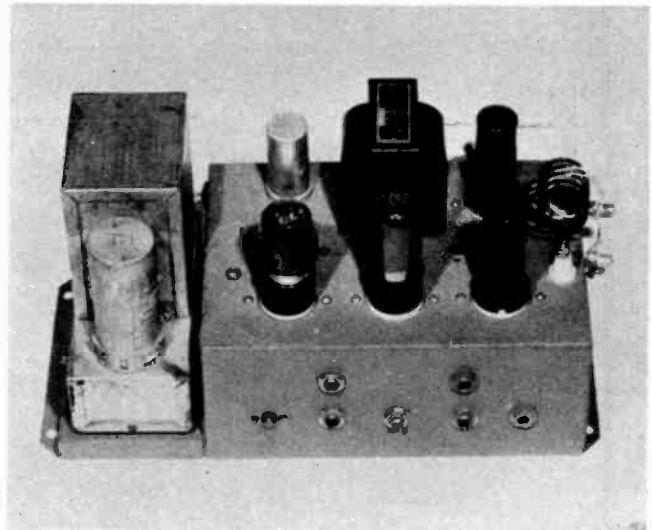

Figure 19.
TOP VIEW OF THE MOBILE TRANSMITTER.

20 WATT 6 AND 10 METER MOBILE TRANSMITTER

The simple mobile transmitter shown in Figures 19 and 20 has been rebuilt on the chassis of an older mobile transmitter which saw intermittent automobile service over a period of years. The unit may be operated on either the 6 or 10 and 11 meter bands simply by changing the crystal, retuning the two exciter tank circuits and changing the output tank coil. The unit is designed to take the full output of a standard 300-volt 100-ma. vibrator power pack. The operating currents of the various stages normally are: oscillator plate current, 8 ma.; multiplier plate current, 15 ma.; final grid current, 6 to 9 ma.; final plate current, 75 ma.

Modulation System The unit has been designed for use with a completely separate audio channel for amplitude modulation of the final stage. In many cases it may be possible to use the audio system of an automobile

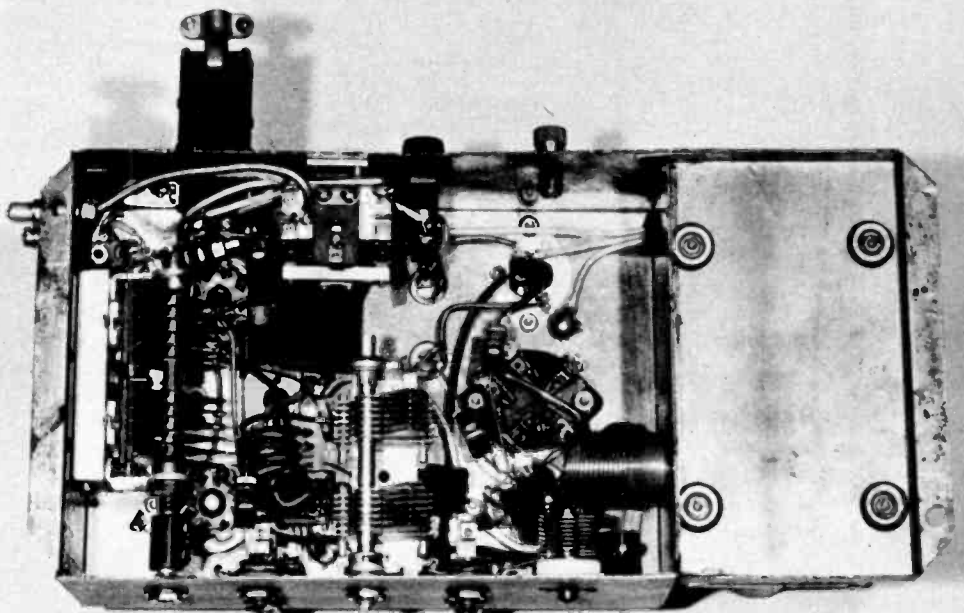

Figure 20.
UNDER SIDE OF THE MOBILE TRANSMITTER.

The antenna-changeover relay is built into the chassis. Since coaxial line is used to feed the antenna, the other set of contacts on the d.p.d.t. relay is used to apply the current to the primary of the vibrator power pack.

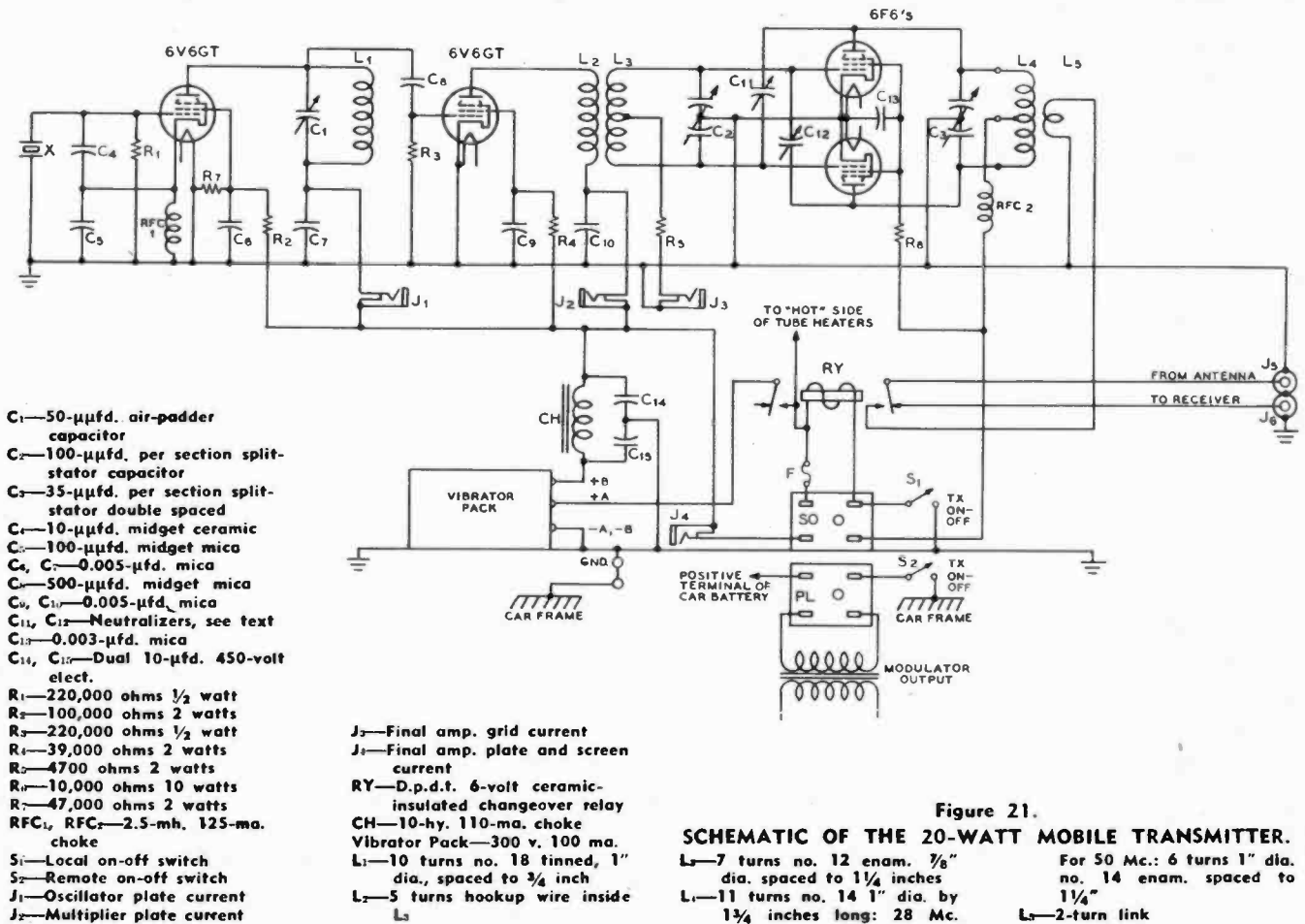

Figure 21.

SCHEMATIC OF THE 20-WATT MOBILE TRANSMITTER.

L₁—7 turns no. 12 enam. 7/8" dia. spaced to 1 1/4 inches
 For 50 Mc.: 6 turns 1" dia. no. 14 enam. spaced to 1 1/4"
 L₂—5 turns no. 14 1" dia. by 1 1/4 inches long: 28 Mc.
 L₃—2-turn link

receiver as the modulator. Several of the larger automobile receivers provide up to 10 watts of average audio output power which is more than adequate for full modulation of this transmitter. If a separate modulator is desired, a simple arrangement using one 2E30 as a driver and a pair of 2E30's as modulators may be used. An alternate modulator for use only with a carbon microphone could use a pair of 2E30's in class A₁ with the grids fed in push pull directly from the microphone transformer. Modulators using both the circuit arrangements are described in a bulletin on the type 2E30 tube which is available from Hytron Radio and Electronics Corp., Salem, Mass.

Transmitter Circuit The oscillator circuit uses a 6V6GT tube in a hot-cathode Colpitts oscillator-multiplier as described in Chapter 6. The unit is designed for use with a 6790 to 7425 kc. crystal for the 11 meter and 10 meter band, and for use with an 8.3 to 9.0 Mc. crystal for the 6-meter band. The plate circuit of the oscillator is tuned to twice the crystal frequency for the 10 and 11 meter bands and to three times the crystal frequency for the 6-meter band. The coil dimensions shown in the caption to Figure 21 are for coils which will give tuning of both bands.

The multiplier stage uses another 6V6GT and its plate circuit is inductively coupled to a split-stator tank circuit which excites the grids of the push-pull final amplifier stage. This tank circuit tunes from 27 to 34 Mc.

The final amplifier uses a pair of 6F6 tubes, although 6V6's may be used if 6F6's are not available. The 6V6's may give a tendency toward instability if the amplifier is mistuned, but

the 6F6's have proven to be perfectly stable due to their lower G_m and lower inter-electrode capacitances. The neutralizing capacitors C₁₁ and C₁₂ in Figure 21 actually consist only of leads running from the plate of each tube to the no. 6 pin on the socket of the opposite tube. The no. 6 pin on the tube socket is not connected within the tube. Nevertheless, its capacitance to the opposite grid acts as a neutralizing capacitance and has proven to be approximately the correct value to obtain stable operation from the tubes.

Control Circuit The control circuit of the transmitter is more or less conventional. A d.p.d.t. isolantite-insulated relay inside the chassis of the transmitter is used for antenna changeover and also to apply 6-volt power to the vibrator pack. With this circuit arrangement it is anticipated that a heavy-current relay or a switch directly at the car battery will be used to light the heaters of the transmitter tubes and place the transmitter in the stand-by condition.

50 WATT MOBILE OR FIXED STATION TRANSMITTER WITH QUICK-HEATING TUBES

Figures 22 and 23 illustrate a 50-watt 27 to 29.7 Mc. and 50 to 54 Mc. transmitter which may serve a dual purpose as both a mobile transmitter when installed in an automobile and as a medium-power fixed-station transmitter. It is only necessary to install the transmitter in the appropriate place with the proper power supply for either type of operation. Quick-heating filament type tubes have been used so as to eliminate power drainage from the battery during the stand-by period when the unit is in use for mobile work.

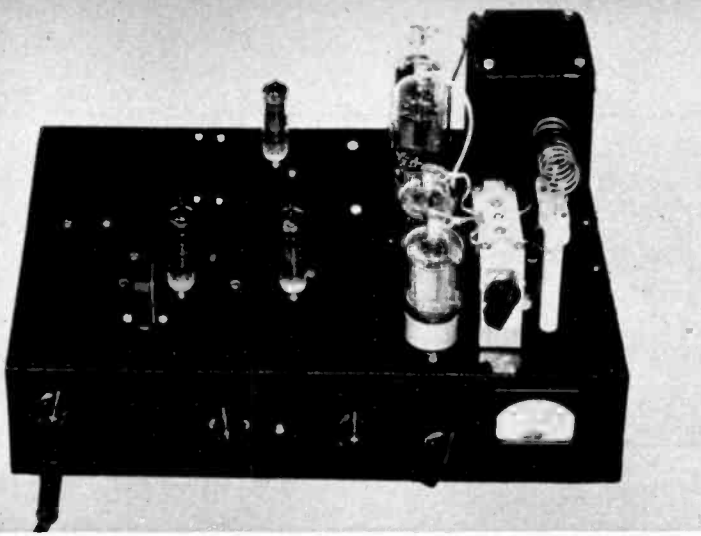

Figure 22.
FILAMENT-TUBE 50-WATT MOBILE TRANSMITTER.

Power Supply For mobile use the unit is designed to operate from a 450 to 500 volt, 150 to 200 ma. dynamotor. The surplus model PE103 dynamotor which has been so widely available is excellent for the job. For fixed station use a 450-volt 175-ma. power supply is required for the complete transmitter.

Although the use of filament tubes in a mobile transmitter is a great operating advantage, there is an attendant disadvantage brought about by the fact that cathode bias cannot be used on any of the stages. Hence in the unit being described it was deemed best to include a small 22.5-volt tapped C battery for grid bias supply on the speech amplifier stage and upon the modulator stages. Since the current drain on this battery is substantially negligible, the rated shelf life of the unit should be obtained in service. Straight grid-leak bias is used on all the r-f amplifier stages in the equipment.

Microphone current for mobile operation of the equipment is obtained by connecting pin 3 on the power cable to pin 8. If ripple is encountered it may be desirable to use a separate 4.5-volt battery for the microphone as shown on the schematic diagram. A filter system consisting of a 1000-ohm resistor and a 25- μ fd. capacitor is used to attenuate dynamotor ripple which may appear on the 6-volt filament line. Make sure that capacitor C₁₀ is poled correctly. For fixed station operation a

4.5-volt C battery may be used for microphone current supply or, as would be more likely, the output from a conventional speech amplifier may be fed into terminals 5 and 2 on the power plug. The complete method of connecting the power plug for the equipment for both fixed station and mobile operation is shown in conjunction with the schematic diagram of Figure 24.

A 2E30 tube is used as a hot-cathode Colpitts crystal oscillator with its plate circuit tuned to twice the frequency of the crystal in use. Since a filament type tube is in use for this stage, it was necessary to wind a bifilar type coil for insertion in series with the filament of the tube. With the coil constructed as shown in the coil table and with the values of capacitance given in the circuit diagram of Figure 24, quite satisfactory operation with good harmonic output is obtained with crystals over the 6.5 to 9 Mc. range. The second 2E30 tube is used as a doubler to the 10-meter band and may be used either as a doubler or as a tripler to the 6-meter band. If this stage is used as a tripler, the plate circuit of the first 2E30 is tuned to twice crystal frequency as mentioned previously. However, it may be possible to obtain slightly greater excitation power on the grid of the final amplifier by operating the first 2E30 as a tripler and the second stage as a doubler to the 6-meter band. The plate circuit of the second 2E30 tunes over the complete frequency range from 27 to 54 Mc.

The 5516 push-pull final amplifier is quite conventional in its circuit arrangement. It was determined to be unnecessary to neutralize this amplifier since complete stability was obtained on both frequency bands of operation. Plug-in coils are used in the plate circuit of the 5516 final r-f amplifier. Data for these coils is given under the schematic diagram.

High-level plate modulation of the final amplifier stage is used in the transmitter unit. The speech amplifier system consists of a pentode audio voltage amplifier with sufficient power output to drive the grids of a pair of 2E25 tubes which are used as a Class AB₂ power amplifier. Ample gain for operation from a single-button carbon microphone is provided by this circuit arrangement.

A 0-10 d-c milliammeter is used in conjunction with a meter switch to measure the significant currents in the transmitter equipment. Provision has been made for measuring the grid current of the 2E30 multiplier stage and the grid current of the

Figure 23.
UNDERSIDE OF THE FILAMENT-TUBE MOBILE TRANSMITTER.

The bias battery for the audio stages of the transmitter may be seen mounted in one corner of the chassis.

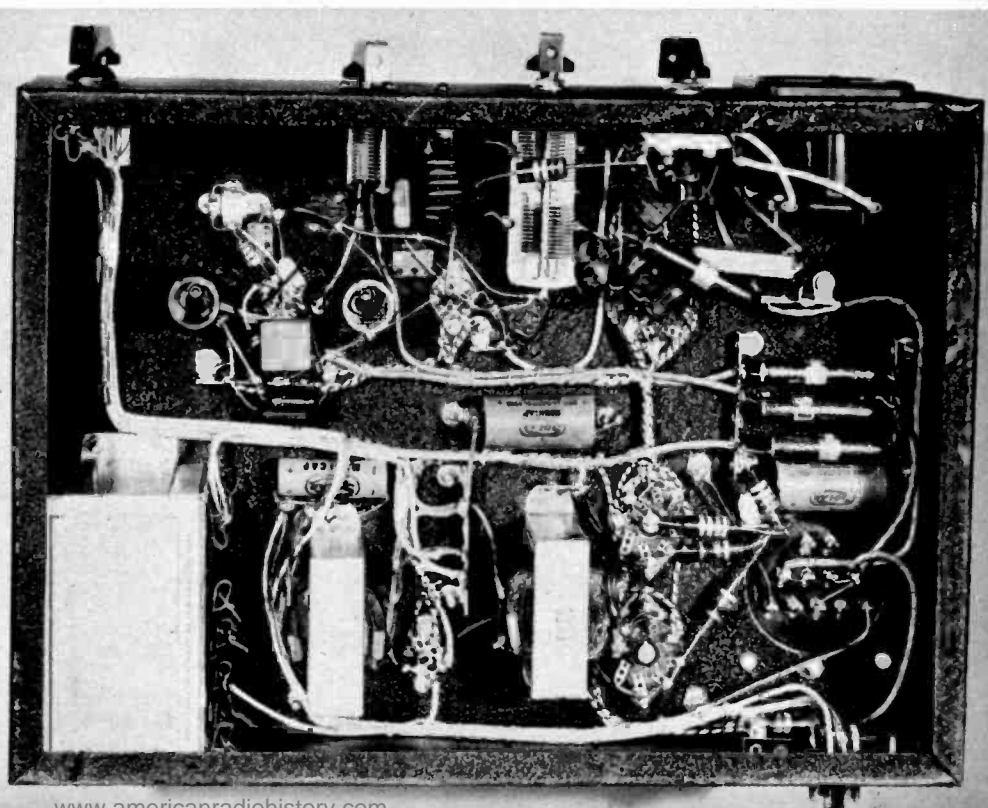

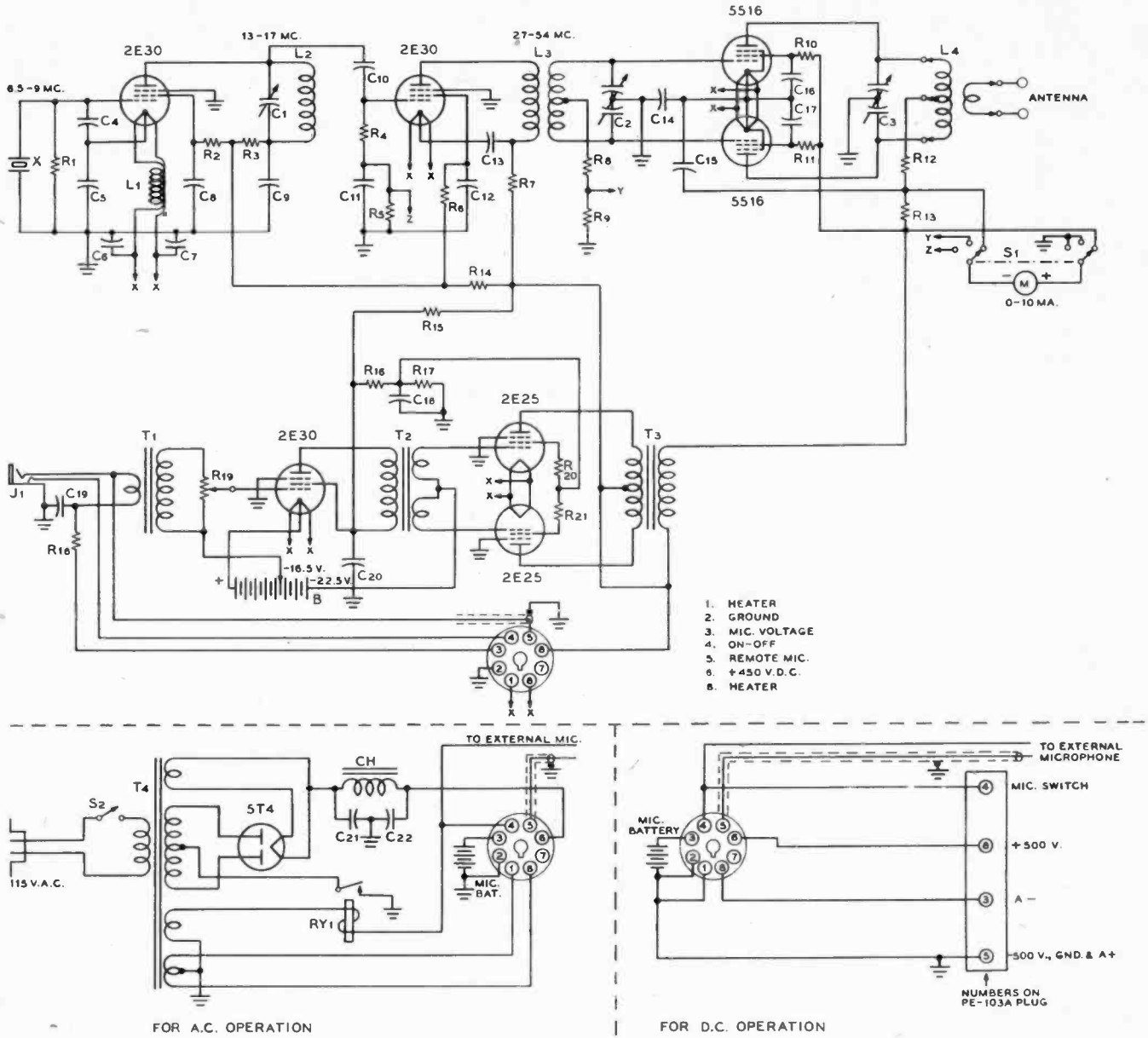

Figure 24.

SCHEMATIC DIAGRAM OF THE 50-WATT TRANSMITTER.

- C₁—100- μ fd. APC with shaft
- C₂—100- μ fd. per section, midget split-stator capacitor
- C₃—30- μ fd. per section, midget double-spaced split stator
- C₄—15- μ fd. midget ceramic
- C₅—150- μ fd. midget mica
- C₆, C₇, C₈, C₉—0.003- μ fd. midget mica
- C₁₀—50- μ fd. midget mica
- C₁₁, C₁₂, C₁₃, C₁₄, C₁₅, C₁₆, C₁₇, C₁₈—0.003- μ fd. midget mica
- C₁₉—8- μ fd. 450-volt elect.
- C₂₀—25- μ fd. 25-volt elect.
- C₂₁, C₂₂—5- μ fd. 600-volt oil

- R₁—100,000-ohm 1/2-watt
- R₂—100,000 ohms 2 watts
- R₃—100 ohms 2 watts
- R₄—100,000 ohms 1/2 watt
- R₅—100 ohms 1/2 watt
- R₆—100,000 ohms 2 watts
- R₇—10,000 ohms 10 watts
- R₈—22,000 ohms 2 watts
- R₉, R₁₀, R₁₁, R₁₂—100 ohms 2 watts
- R₁₃—200-ma. shunt for M
- R₁₄, R₁₅—15,000 ohms 10 watts
- R₁₆—22,000 ohms 2 watts
- R₁₇—47,000 ohms 2 watts
- R₁₈—1000 ohms 2 watts
- R₁₉—500,000-ohm potentiometer
- R₂₀, R₂₁—100 ohms 2 watts

- X—6.5 to 7.4 Mc. for 10-11 meter band; 8.33 to 9.0 Mc. for 6-meter band
- T₁—Carbon mike to grid trans.
- T₂—Small single tube to Class B grids driver transformer
- T₃—20-watt universal mod. trans.
- T₄—200-ma. plate trans. for 450 v.
- S₁—2-pole 3-position meter sw.
- S₂—5-p.s.t. toggle switch
- M—0-10 d-c millimeter
- RY₁—6.3-volt a-c relay
- B—22.5-volt tapped "C" battery

- L₁—20 turns of two strands no. 22 enam. wound side by side. Closewound on 3/4" dia. coil form
- L₂—13 turns no. 20 enam. spaced to 1" on 3/4" dia. coil form
- L₃—8 turns no. 14 enam. air-wound, 3/4" dia. spaced to 1 1/4", center tapped, with 6 turns hookup wire wound 1/2" dia. inside as plate coil on 2E30 stage
- L₄—28-Mc.: mfrd. 50-watt center-link plug-in coil; 50-Mc.: 8 turns 3/4" dia. spaced to 1 1/2", 2-turn link

push-pull 5516 final amplifier. Also through the use of a shunt in series with the plate voltage lead for the 5516's it is possible to measure the plate current of this stage. The shunt was constructed of two lengths of resistance wire approximately one inch long of the type removed from an old filament center-tap resistor. The value of resistance of the shunt was varied until

the full scale reading of the 0-10 milliammeter was increased to 200 ma.

When a PE-103 dynamotor is used to power the transmitter it may be necessary to short out circuit breaker 3E5 to eliminate the drop across the coil of this circuit breaker which is in series with the filament circuits.

Speech and Amplitude-Modulation Equipment

IN THIS chapter there are shown two conventional speech amplifiers, a clipper-filter speech amplifier, a representative Class B modulator of standard design, and a bias pack and grid-modulator unit designed from a new standpoint which simplifies the operation and adjustment of a grid-modulated stage.

The audio equipment required in an amplitude-modulated phone transmitter will vary widely with different types of microphones, different modulation systems, and differing amounts of power to be modulated. Since it would be virtually impossible to show designs for the complete audio system for any type of application, three practical types of speech amplifier circuits are shown, and a particular design for a more or less standard type of Class B modulator has been included. The design of any other Class B or Class AB modulator is a relatively simple process, and can be done with the aid of Table III of Chapter 4.

The speech amplifier which drives the high-level modulator may be either a separate unit such as those shown in the first part of this chapter, the speech amplifier may be included with the modulator in the manner shown in the complete 807 transmitter described in Chapter 26, or the high-level stages and the driver may be included with the modulator and the combination fed from a zero-level line driven by a speech amplifier such as the clipper-filter amplifier shown at the end of this chapter. A complete modulator built around a BC-375E transmitter housing is described in Chapter 32.

SPEECH AMPLIFIER, DRIVER, OR GRID MODULATOR WITH DEGENERATIVE FEEDBACK

Figures 1, 2, and 3 illustrate a simple 8-watt amplifier specifically designed to operate from a crystal microphone and to be used as a speech amplifier for an amplitude-modulated

**Figure 1.
LOOKING DOWN ON THE 8-
WATT 6L6 FEEDBACK
SPEECH AMPLIFIER**



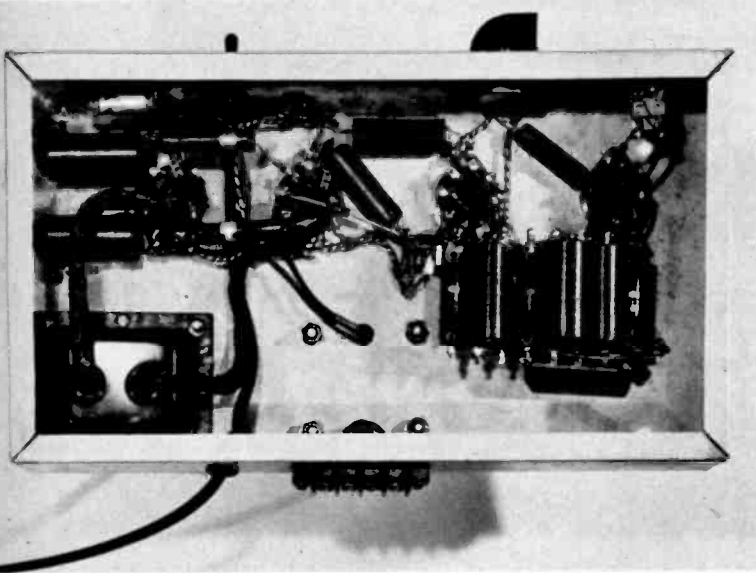

Figure 2.
UNDERCHASSIS VIEW OF THE 8-WATT SPEECH
AMPLIFIER/DRIVER UNIT.

phone transmitter. A single-ended 6L6 is used as the output stage with degenerative feedback from the plate of the 6L6 back to the plate of the preceding amplifier. The use of degenerative feedback greatly lowers the effective plate impedance of the 6L6 and affords a considerable reduction in the harmonic distortion normally introduced by the operation of a single ended beam-tetrode stage. The reduction in the plate impedance of the 6L6 feedback effectively improves the regulation of the output voltage with respect to changes in loading such as caused by variation in grid impedance of a Class B modulator stage.

The Feedback Circuit The addition of a single resistor, R_{10} , from the plate of the 6L6 back to the plate of the 6SJ7 amplifier stage provides the feedback circuit

for the amplifier. The incorporation of this resistor reduces the harmonic distortion, as measured at the output of the amplifier, from approximately 14% down to less than 3% at 8 watts output. The addition of the resistor for the shunt feedback arrangement reduces the gain of the amplifier by approximately 12 db. However, a single-ended 6J5 triode amplifier stage has been incorporated ahead of the 6SJ7-6L6 feedback pair to give ample gain for operation from a conventional diaphragm-type crystal microphone. The gain of the amplifier is such that full output from the 6L6 can be obtained with approximately 30 millivolts applied to the grid of the 6J5.

The Power Supply Power supply bias is used on the 6L6 stage. This bias voltage is obtained by the drop across resistor R_{11} in series with the center tap of the power transformer. The hum voltage which is present across R_{11} is filtered out by the network R_{12} - C_7 to provide a fixed bias voltage of approximately 18 volts for the grid of the 6L6. The balance of the power supply circuit is conventional with successive decoupling networks to the low-level speech amplifier stages.

The Output Circuit The plate of the 6L6 is coupled to the load by means of the transformer T_1 . This transformer is designed for a maximum of 80 ma. primary current and is intended to feed directly the grids of a Class B modulator stage. The transformer may be used in this manner if desired or the two secondaries may be connected in series to feed a 500-ohm line which may then be matched to the grids of the Class B modulator stage at a remote point. The optimum value of load impedance for the 6L6 stage is approximately 4000 ohms.

This 8-watt feedback amplifier is fully capable of driving any of the Class B modulator combinations listed on Table III of Chapter 4 where the maximum signal driving power is listed as being less than approximately 5 watts. It is not ordinarily considered good practice to utilize the full output capability of a driver stage for feeding the grids of a Class B modulator. Some reserve of audio power should always be available if distortion is to be held to a minimum.

The speech amplifier described is also quite satisfactory for

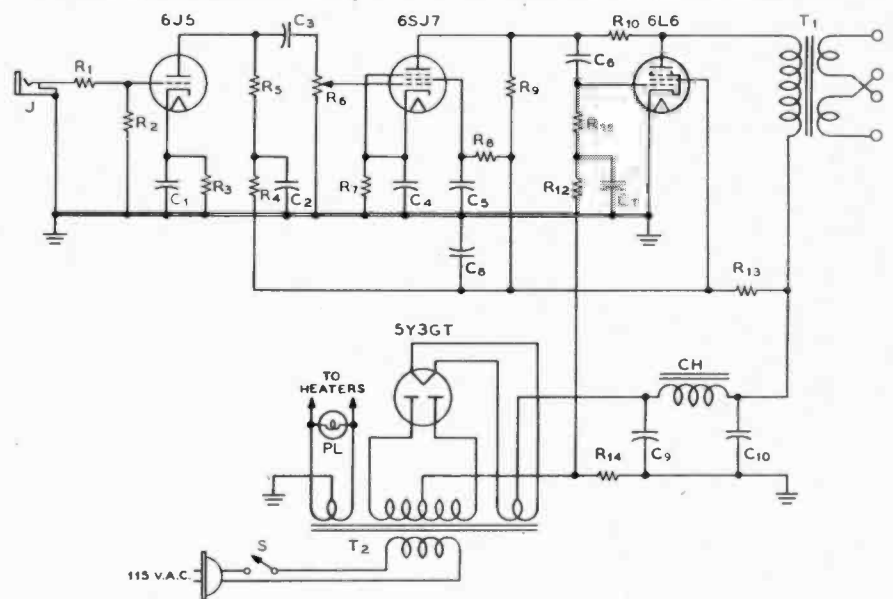

- C_1 —25- μ fd. 25-volt elect.
- C_2 —8- μ fd. 450-volt elect.
- C_3 —0.01- μ fd. 600-volt tubular
- C_4 —25- μ fd. 25-volt elect.
- C_5 —0.1- μ fd. 600-volt tubular
- C_6 —0.05- μ fd. 600-volt tubular
- C_7 —25- μ fd. 25-volt elect.
- C_8, C_9, C_{10} —8- μ fd. 450-volt elect.
- R_1 —47K $\frac{1}{2}$ watt
- R_2 —1.0 meg. $\frac{1}{2}$ watt
- R_3 —1000 ohms 2 watts
- R_4 —22K 2 watts
- R_5 —220K $\frac{1}{2}$ watt
- R_6 —500K potentiometer
- R_7 —1800 ohms 2 watts
- R_8 —1.0 megohm $\frac{1}{2}$ watt
- R_9 —220K $\frac{1}{2}$ watt
- R_{10}, R_{11} —470K $\frac{1}{2}$ watt
- R_{12} —47K 2 watts
- R_{13} —5000 ohms 10 watts
- R_{14} —200 ohms 10 watts
- J—Microphone jack
- T_1 —Single plate to Class B grids driver transformer
- T_2 —700 c.t., 90 ma.; 5v. 3 a.; 6.3 v. 3.5 a.
- CH—8.0 hy. at 85 ma.
- S—A-C line switch
- PL—6.3-volt pilot lamp

Figure 3.
SCHEMATIC DIAGRAM OF THE 8-WATT AMPLIFIER.

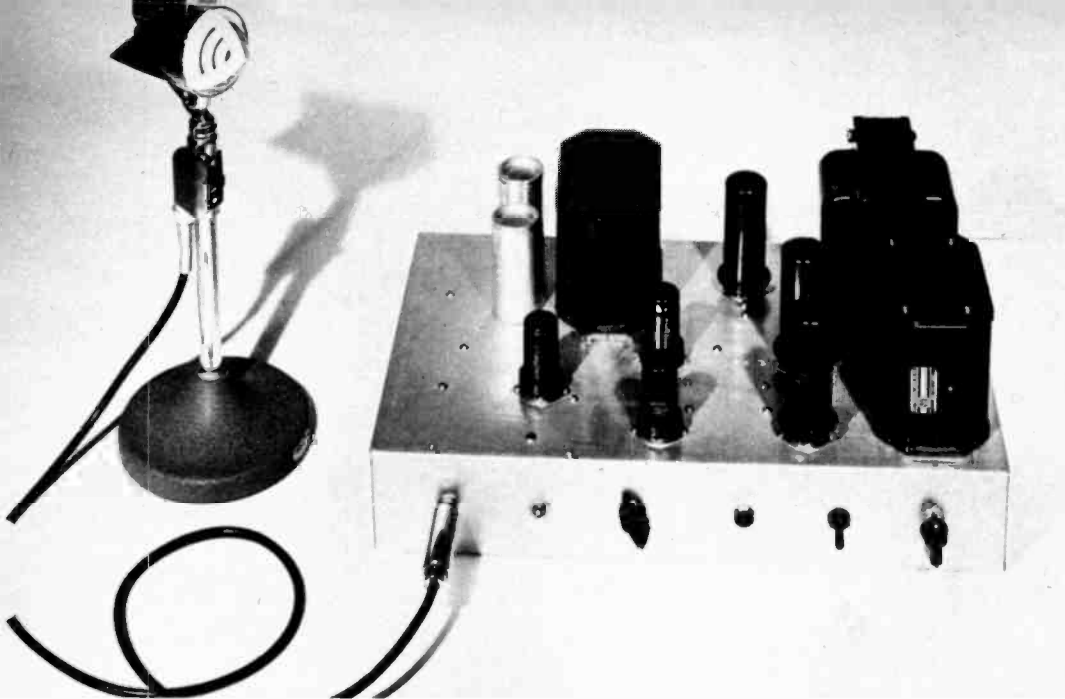

Figure 4.
**TOP VIEW OF THE 20-WATT
 HIGH-QUALITY AMPLIFIER.**
*The components on the front drop
 of the chassis are: microphone jack,
 high gain-low gain switch, gain
 control, pilot lamp, a-c line switch,
 and output impedance control.*

use as a modulator in a grid-bias-modulated transmitter. In this application it is capable of grid modulating Class C amplifier stages with as much as one kilowatt input. The amplifier described has been used for quite a period of time as speech amplifier-driver for the 200-300 watt Class B modulator described later in this chapter (Figures 7, 8, and 9).

HIGH-FIDELITY 20-WATT AMPLIFIER

Many amateurs desire to use the speech amplifier of the transmitter as a high-quality phonograph amplifier on various occasions. The 20-watt amplifier shown in Figures 4, 5, and 6 is designed to fill this need and also to serve as a wide-range low-distortion phonograph amplifier for amateurs not interested in radiotelephony and for persons primarily interested in high-quality reproduction.

Although no bass-boost or high-boost circuits have been provided, there is ample overall gain so that such circuits may be inserted between the plate circuit of the first 6SJ7 and the volume control.

The Circuit of the Amplifier A 6SJ7 tube has been used in the conventional manner as a high-gain input stage.

The volume control has been inserted between the plate circuit of this tube and the grid circuit of the succeeding amplifier. A pair of 6SJ7's are used in a "floating paraphrase" phase inverter to excite the grids of the push-pull 6L6 final amplifier. 14 db of degenerative feedback from the plate of one 6L6 to the cathode of the first 6SJ7 phase inverter has been incorporated into the amplifier to improve the frequency response and phase characteristics, and to reduce the harmonic distortion and inter-modulation distortion to a very low value.

The frequency response of the amplifier as shown is down 1.5 db at 90 and 10,000 cycles from the 1000 cycle gain. It is down 3 db at 60 and 15,000 cycles and down 5.2 db at 30 cycles. The total harmonic distortion of the amplifier is less than one per cent up to about 18 watts output and the peaks of the output wave are slightly flattened at 20 watts output into a 500-ohm resistive load.

Resistor R_{21} is adjusted until under normal line voltage conditions the plate to cathode voltage on the 6L6's is 360 volts.

Figure 5.
**UNDERCHASSIS VIEW OF THE
 AMPLIFIER.**

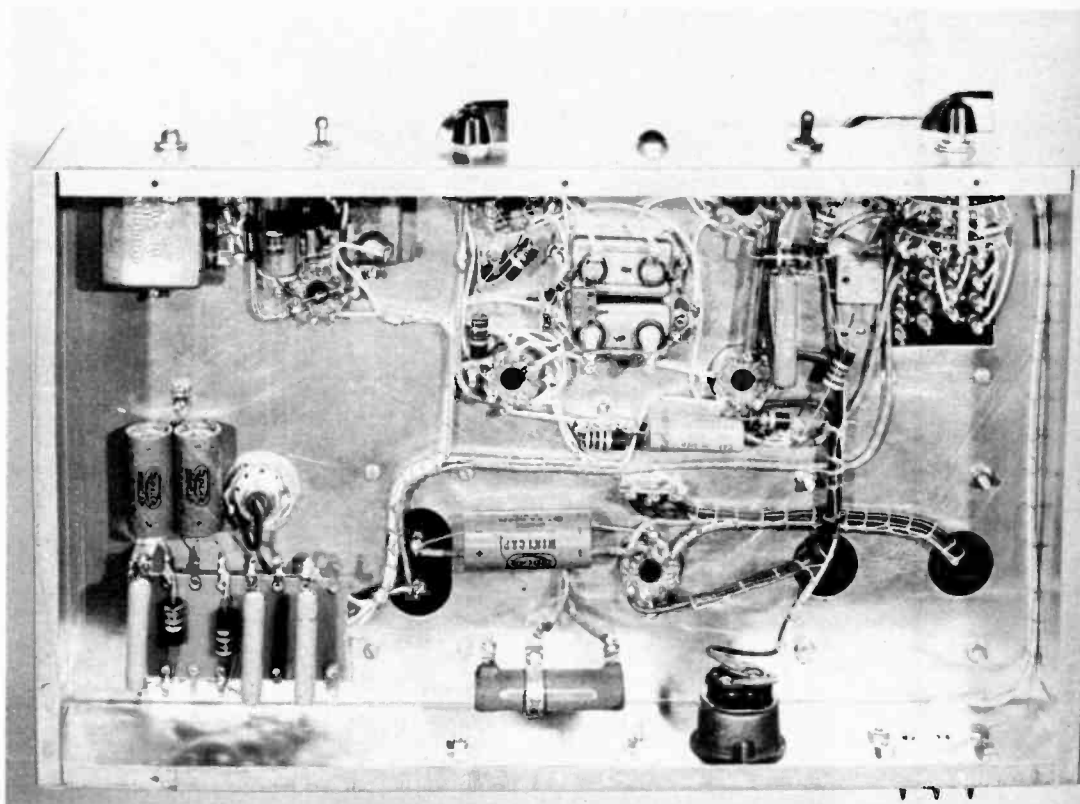

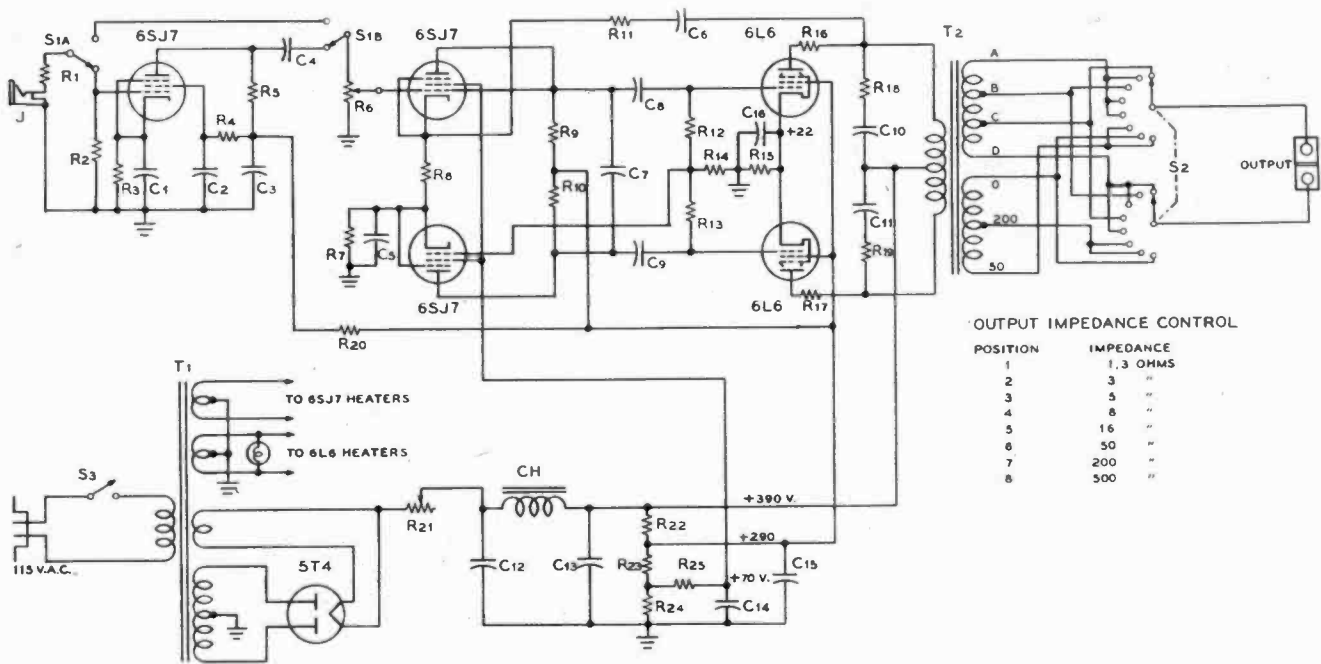

Figure 6.

SCHEMATIC DIAGRAM OF THE HIGH-QUALITY AMPLIFIER.

- C₁—25- μ fd. 25-volt elect.
- C₂—0.5- μ fd. 400-volt bathtub
- C₃—8- μ fd. 450-volt elect.
- C₄—0.025- μ fd. 400-volt bathtub
- C₅—25- μ fd. 25-volt elect.
- C₆—0.05- μ fd. 600-volt tubular
- C₇—50- μ fd. midget mica
- C₈, C₉—0.1- μ fd. 600-volt bathtub
- C₁₀, C₁₁—0.003- μ fd. mica
- C₁₂—8- μ fd. 525-volt elect.
- C₁₃—40- μ fd. 450-volt elect.

- C₁₄—30- μ fd. 150-volt elect.
- C₁₅—40- μ fd. 450-volt elect.
- C₁₆—25- μ fd. 25-volt elect.
- R₁—47,000 ohms 1/2 watt
- R₂—1.0 megohm 1/2 watt
- R₃—1800 ohms 2 watts
- R₄—2.7 megohms 1/2 watt
- R₅—470,000 ohms 1/2 watt
- R₆—500,000-ohm potentiometer
- R₇—1000 ohms 2 watts
- R₈—270 ohms 2 watts

- R₉, R₁₀—220,000 ohms 1/2 watt
- R₁₁—47,000 ohms 2 watts
- R₁₂, R₁₃—100,000 ohms 1/2 watt
- R₁₄—47,000 ohms 1/2 watt
- R₁₅—250 ohms 10 watts
- R₁₆, R₁₇—100 ohms 2 watts
- R₁₈, R₁₉—4700 ohms 2 watts
- R₂₀—47,000 ohms 2 watts
- R₂₁—500 ohms 25-watt slider type
- R₂₂—4000 ohms 10 watts

- R₂₃—10,000 ohms 10 watts
- R₂₄—5000 ohms 10 watts
- R₂₅—47,000 ohms 2 watts
- T₁—850 c.t. 200 ma., 5 v. 3 a., 6.3 v. 5 a., 6.3 v. 3 a.
- T₂—30-watt plates to line or voice coil
- CH—10-hy. 200-ma. filter choke
- S_{1A}, S_{1B}—D.p.d.t. toggle sw.
- S₂—2-pole 8-position wafer sw.
- S₃—S.p.s.t. a-c line sw.

POSITION	IMPEDANCE
1	1.3 OHMS
2	3 "
3	5 "
4	8 "
5	16 "
6	50 "
7	200 "
8	500 "

With the resistor values shown the screen voltage should be 270 volts and the cathode voltage 22 volts.

The output transformer used with the 6L6's has a number of secondary taps so that load impedances from 500 to 1.5 ohms may be matched. Switch S₂ has been included in the amplifier so that the proper tap for operation into a 500, 200 or 50 ohm line for feeding a transmitter or speaker transformer, or into a low value of impedance for feeding a voice coil directly.

The amplifier has a very low hum level and is capable of giving very pleasing reproduction when feeding a loudspeaker. When it is desired to operate the amplifier from a high-level signal of several volts in peak amplitude it is only necessary to change S₁ to the low-gain position. With the switch in this position it is possible to feed a signal of quite high level into the input terminal of the amplifier since the gain-control potentiometer is between the input jack and the grid of the 6SJ7 tube.

Should the amplifier be used as a driver for a high-power Class B modulator, adequate power is available without overload for exciting the grids of any tubes requiring not more than about 15 watts maximum-signal driving power.

200-300 WATT CLASS B MODULATOR

The unit illustrated in Figures 7, 8 and 9 was designed for use with the 450-watt 813 transmitter described and shown in Chapter 26. In this application with 1000 volts on the plates of the Class B tubes the unit delivers from 175 to 200 watts of average power for plate modulation of the 813. With 1250 to 1500 volts on the tubes the unit can deliver up to 300 watts with HY-5514 tubes or 225 watts with 811 tubes. Approxi-

Figure 7.

REAR VIEW OF THE MODULATOR UNIT.

Showing the placement of components on the chassis. The actual components for the HY-5514 modulators are on the left side of the chassis in this view, and the bias pack is on the right-hand side. The screen choke for the 813 stage which is modulated by this unit is to the rear of the bias pack portion. The phone c-w switch can be seen mounted on the front panel.

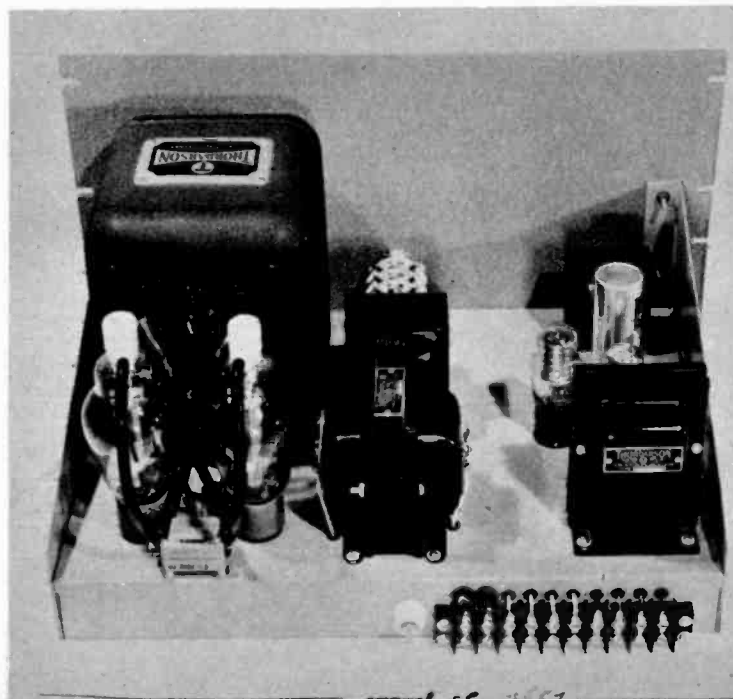

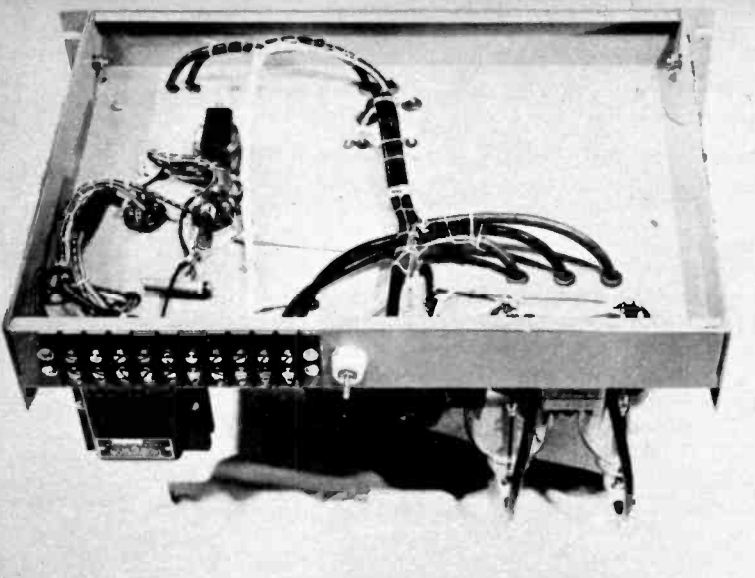

Figure 8.
UNDERCHASSIS VIEW OF THE MODULATOR UNIT.

mately 5 watts maximum audio driving power is required to excite the grids of the Class B tubes. The unit has been designed for use with a separate speech amplifier whose output power is fed to the modulator by means of a 200-ohm or 500-ohm line. The single 6L6 feedback speech amplifier described earlier in this chapter has been used with this modulator for a period of time and has proven to be quite satisfactory.

Mica capacitors have been placed across the primary and secondary of the modulation transformer, using the system of "building out" described in Chapter 7, to cut off all audio frequencies or audio harmonics above approximately 3000 cycles. This procedure affords a considerable reduction in side-band splatter. The particular values of capacitance shown have proven to be optimum for the Thordarson T11M77 transformer connected as shown in the unit.

Since the modulator unit has been designed for plate modulation of a beam-tetrode stage, provision has been made for accomplishing simultaneous screen modulation. The system used is the very simple and quite satisfactory method of inserting a choke in series with the screen-voltage supply lead of the modulated stage.

The phone-c-w switch incorporated into the unit accomplishes the following functions when the switch is thrown from the phone position to the c-w position: (1) the secondary of the modulation transformer is shorted (2) the series screen choke is shorted (3) the filament voltage is removed from the Class B modulator tubes. In the phone position, of course, all these conditions are reversed.

A bias pack has been included in the unit since ample space was available on one side of the chassis and since a bias pack is required for excitation keying of the usual amplifier stage. The particular circuit shown is satisfactory for obtaining grid bias for any Class C amplifier tube requiring a minimum bias of approximately 100 volts and not drawing more than 50 ma. maximum grid current. With 50 ma. of grid current the voltage drop across the bias pack is approximately 160 volts. Through the use of the circuit arrangement shown wherein part of the bias current is returned to ground through a resistor rather than having the entire current pass through the VR tube, it is possible for the bias pack to handle 50 ma. instead of the 20 to 30 ma. which would be possible if all current passed through the VR tube.

BIAS PACK AND GRID MODULATOR

The unit illustrated in Figures 10 and 11 has been designed to supply bias for grid-bias modulation of a 1-kilowatt final

amplifier using medium-mu tubes such as the Eimac 250TH, HK-454H, 304TH or 833A. In addition to supplying bias for the final amplifier the unit is constituted to supply bias to the preceding buffer-amplifier stage. The unit also gives clickless grid-block keying of both the final amplifier and buffer stage for c-w operation. Both the keying relay and the 12-volt direct current supply for the keying relay are mounted inside the unit. Provision is also included for bringing out the 12 volts direct current for the operation of an antenna shorting relay such as is used in the BC-312/BC-342 series of receivers. When using this circuit arrangement the antenna shorting relay in the receiver is closed whenever the key is pressed. This desirable protective feature may be added to any other communications receiver simply by adding an external 12-volt antenna shorting relay and connecting this relay to the modulator unit.

Phone-C-W Switch Switch SW in the schematic diagram of Figure 12 is the phone-c-w switch and is arranged so that a particular set of adjustments may be made for phone operation and then by moving the switch to the c-w position the audio is cut off and the final and buffer tubes are biased to cutoff until the key is pressed. Key-up bias on both stages is approximately -450 volts. With the key down the bias is the same as set for phone operation or is variable from about -125 to -400 volts on each stage individually. The unit is designed so that the maximum grid

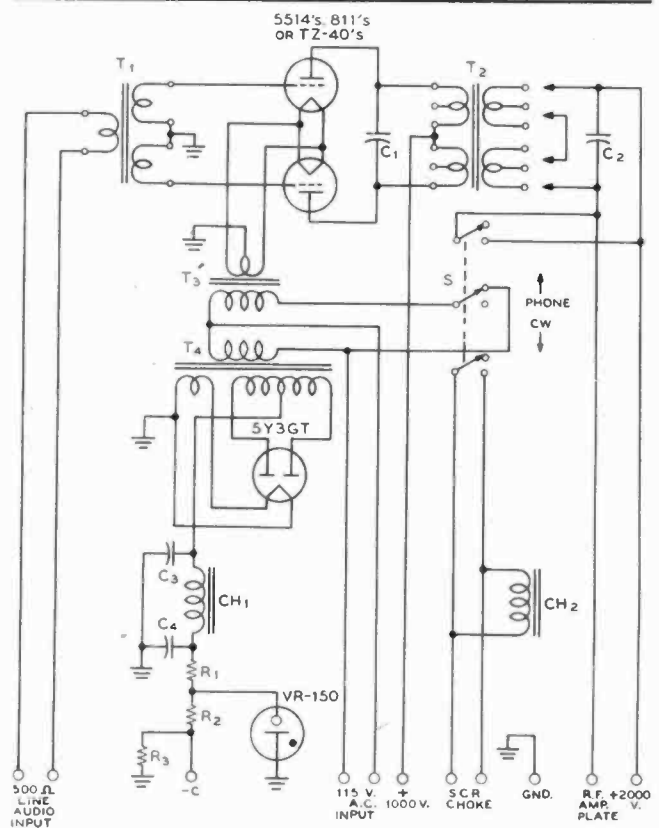

Figure 9.
SCHEMATIC DIAGRAM OF THE MODULATOR UNIT.

- C1—0.004- μ fd. 2500-volt working mica (Two 0.002- μ fd. units in par.)
- C2—0.002- μ fd. 2500-volt working mica
- C3, C4—Dual 8- μ fd. 450-volt elect.
- R1—3000 ohms 10 watts
- R2—2000 ohms 10 watts
- R3—3000 ohms 10 watts
- S—3 p.d.t. 90-degree ceramic sw.
- T1—200 or 500 ohm line to Cl, B grids
- T2—200 to 300 watt modulation trans.
- T3—7.5 volts at 6 amps. for 5514's or TZ-40's or 6.3 v. at 8 a. for 811's
- CH1—10-hy. 40-ma. filter choke
- CH2—15-hy. 85-ma. filter choke

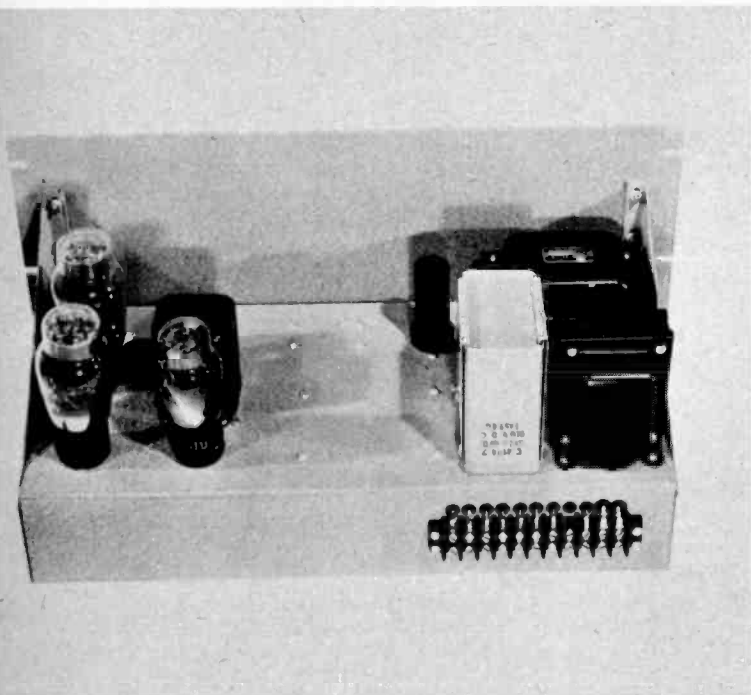

Figure 10.

REAR VIEW OF THE BIAS PACK AND GRID MODULATOR.

current for c-w operation is 50 ma. on the buffer tube and up to 150 ma. on the final amplifier stage. However, the grid current for phone operation will normally be something of the order of 5 to 10 ma. on the final amplifier stage without modulating signal.

The Modulating Signal

The circuit for applying the modulating voltage to the average bias voltage has been described in some detail in Chapter 7. The arrangement uses the cathode-follower circuit for accomplishing both bias regulation and variation of this bias in accordance with the speech wave fed to the grids of the modulator tubes from the separate speech amplifier. The audio output level required of the external speech amplifier is only about one-half watt or +20 db. The audio signal is coupled into the grid modulating tubes through transformer T_1 . This amount of audio power may be obtained from a 6SN7 push-pull stage or from a single 6V6 tube with feedback. The only power actually taken from the speech amplifier is that required to supply losses in T_1 and to develop the desired voltage of approximately 150 to 200 volts peak across R_1 . If it is desired to dispense with the separate external speech amplifier, a 6SJ7 and cascaded 6SN7 stage may be included in the grid modulator unit. In this case T_1 would be replaced by a 2:1 or 3:1 audio interstage transformer and the plate current of the last stage in the speech amplifier would pass through the primary of the interstage transformer.

Cascade Modulation

The grid modulator unit includes provisions for simultaneous in-phase grid modulation of the buffer amplifier and of the final amplifier. The use of this method of cascaded grid modulation greatly improves the linearity of the grid bias modulation method by supplying the extra power from the buffer stage which is required to drive the grids of the final amplifier on positive modulation peaks. The circuit also assists in improving linearity in the region of negative modulation peaks by reducing the output of the buffer amplifier on these negative peaks. Experience has shown that a swamping resistor is not required on the grid of the final modulated stage when using the cascaded grid-bias modulation arrangement. The modulation resulting from the use of this circuit is very linear and clean since distortion in the modulated stage is held to a minimum.

Figure 11.

UNDERCHASSIS VIEW OF THE BIAS PACK AND GRID MODULATOR.

The placement of the various components can be seen quite clearly in this photograph. The small selenium rectifier for the 12-volt relay supply can be seen directly behind the row of three potentiometers. The keying relay is on the far left.

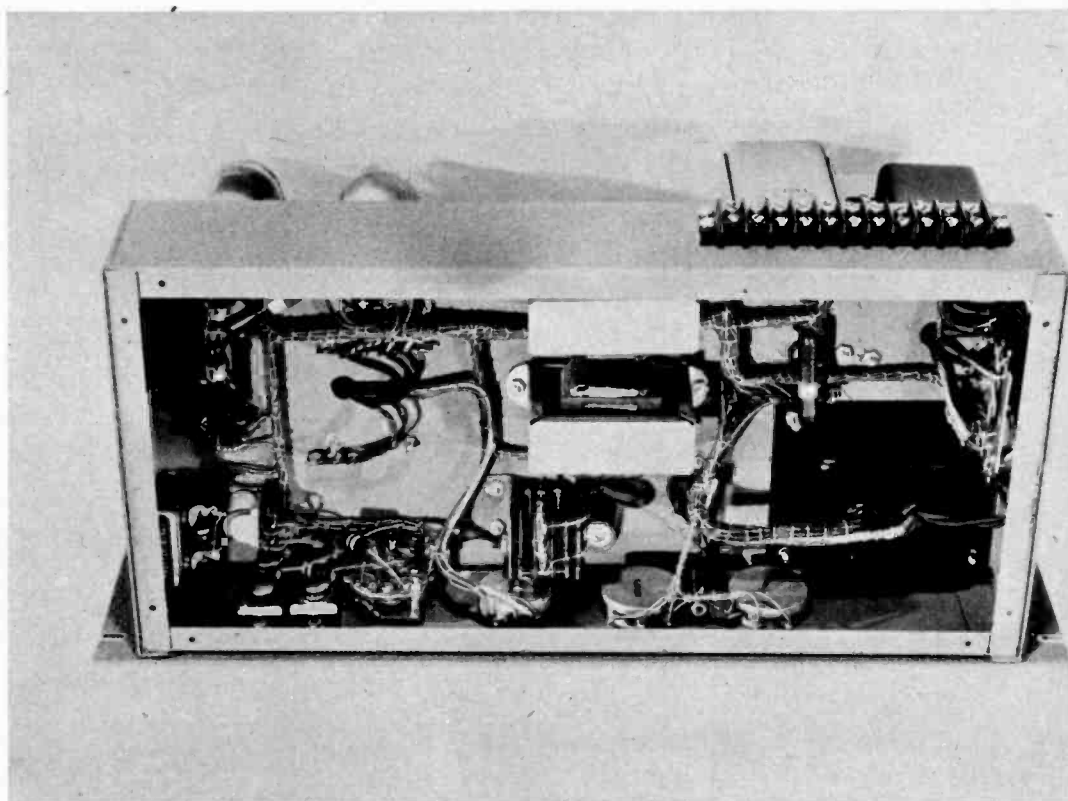

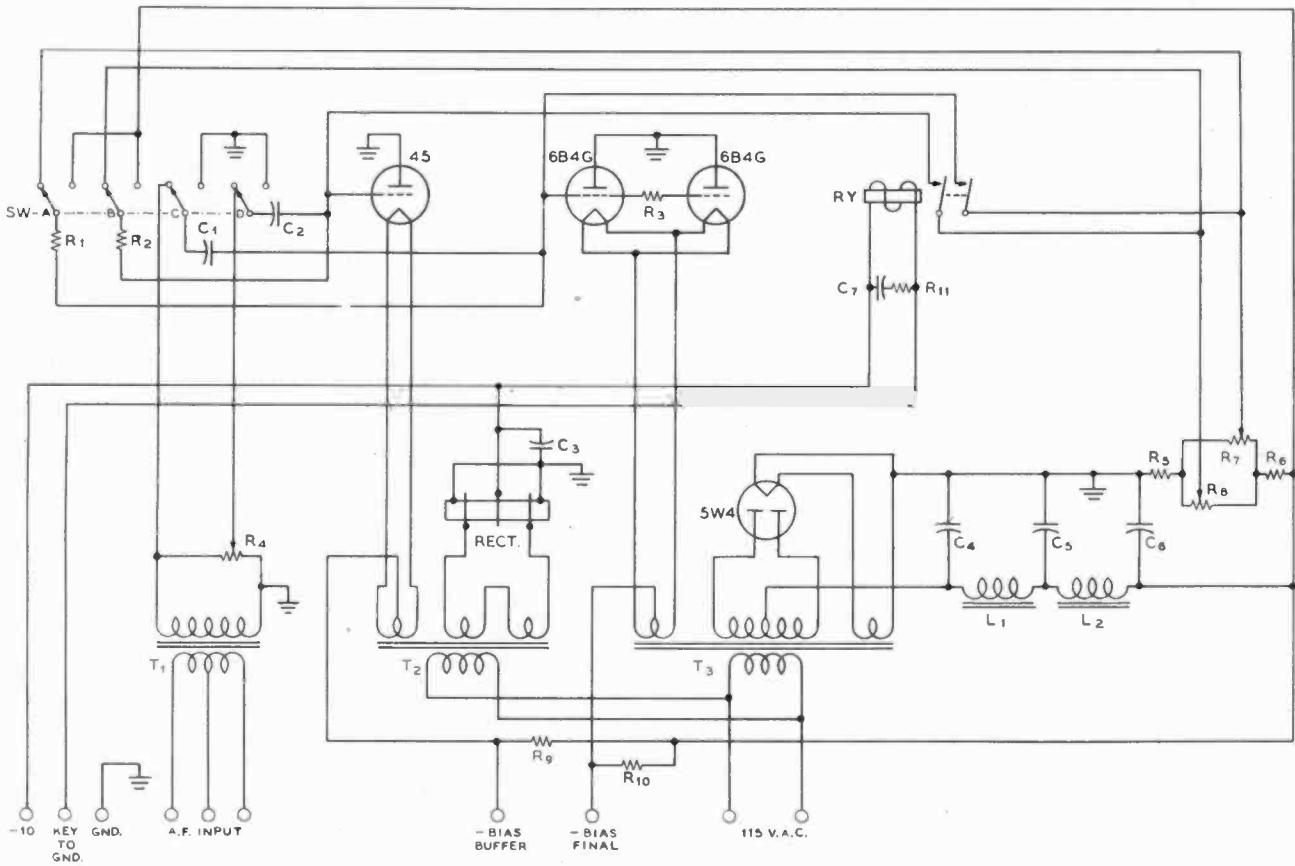

Figure 12.

SCHEMATIC DIAGRAM OF THE BIAS PACK AND GRID MODULATOR.

- | | | | |
|--|--|---|---|
| C ₁ , C ₂ —0.025- μ fd. 600-volt bathtub | R ₁ , R ₂ —100,000 ohms 2 watts | R ₉ —22,500 ohms 10 watts | T ₃ —400-0-400 100 ma., 6.3 v., 5 v. |
| C ₃ —50- μ fd. 25-volt elect. | R ₃ —100 ohms 2 watts | R ₁₀ —12,000 ohms 10 watts | L ₁ , L ₂ —10.5 hy. 110 ma. |
| C ₄ , C ₅ , C ₆ —4- μ fd. 600-volt oil filled | R ₄ —100,000-ohm potentiometer | R ₁₁ —470 ohms 2 watts | SW—4 p.d.t. wafer switch |
| C ₇ —0.1- μ fd. 400-volt bathtub | R ₅ , R ₁₀ —7000 ohms 10 watts | T ₁ —200 or 500 ohms to grid | RY—12-volt d.p.d.t. relay |
| | R ₇ , R ₈ —70,000-ohm wirewound pot. | T ₂ —2.5 v., 5 v., 6.3 v. | Rect—12-volt 250-ma. selenium |

Adjustment Three controls are provided on the front panel of the modulator unit. These controls are: R₁ which adjusts the amount of modulation applied to the buffer stage, R₇ which adjusts the grid bias on the final amplifier stage, and R₈ which adjusts the bias on the buffer amplifier stage. Adjustment of the operation of the unit is accomplished in the following manner: All three controls are put in the far left position so that no audio is applied to the buffer and maximum bias is applied to both stages. Then R₈ is adjusted to approximately mid-scale and R₇ is moved until the bias on the buffer amplifier is such that 5 to 10 ma. of grid current is flowing to the final stage. The antenna coupling to the final stage is then adjusted until approximately normal plate current is flowing.

Sine-wave modulation is then applied, and, using a cathode-ray oscilloscope, the audio input level is adjusted until reasonably complete modulation of the output is obtained. Then potentiometer R₁ is increased until the wave form visible on the oscilloscope is straightened out to appear more closely the same as the modulating sine wave. It is probable that the first set of adjustments will not give the best results and the maximum power output of which the stage is capable so that a succession of adjustments will probably be required to obtain optimum operation of the system. It is quite pleasing to note, nevertheless, the manner in which adjustment of R₁ improves the linearity of operation of the final amplifier over that which is obtained with grid-bias modulation only of the final stage.

Figure 13.

FRONT VIEW OF THE SPEECH AMPLIFIER.

A dynamic microphone is shown plugged into the front panel. The jack on the other side of the front panel is for a crystal microphone. The switch on the lower left side of the front panel selects either dynamic or crystal microphone input. The screw-driver-set potentiometer at the bottom center of the panel is the output level control (R₁₁) after the clipper-filter. The knob at bottom right controls the gain of the speech amplifier (R₂) before the clipper-filter circuit. The unit was constructed in this compact manner so as to take a minimum of space on the operating table.

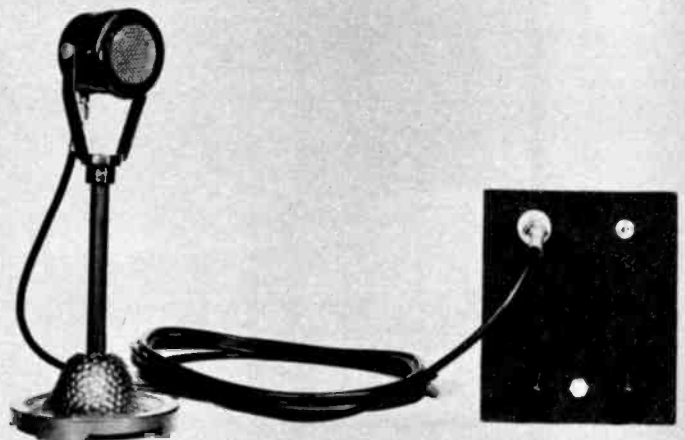

This unit is normally operated in conjunction with the push-pull 250TH amplifier described in Chapter 22. With a power input of 900 watts to the 250TH tubes the plate dissipation is approximately normal or 500 watts, and the output is approximately 400 watts. An unmodulated plate-circuit efficiency of 38 to 44 per cent in the final grid-bias modulated stage can be expected.

CLIPPER FILTER SPEECH AMPLIFIER

It is common practice in broadcast audio systems and in many amateur stations to do all audio distribution at a level of approximately 0 db above 6 milliwatts in a 500-ohm line. This signal level is convenient where telephone lines may be used in the audio system or where it is desired to feed any one of several transmitters from a single speech system. The clipper filter speech amplifier shown in Figures 13, 14, and 15 has been designed to feed an audio level adjustable from -10 to +10 db below 6 milliwatts (0.0006 to 0.06 watts) into a 500-ohm line. The unit has been constructed so as to fit into the operating desk with leads running from it to the various transmitters. Best practice is to connect the various transmitters across the 500-ohm line with bridging transformers so that any transmitter may be operated simply by turning it on. When this is done, the output 500-ohm line should be terminated at one of the transmitters by means of a 500-ohm resistor.

The Circuit The adjustments of clipper filter circuits and a description of the various types has been discussed in detail in Chapter 7. This particular speech amplifier uses an amplifier-clipper with a filter operating at an impedance of 100,000 ohms to cut off all harmonics and audio frequencies above 3500 cycles. The first stage of the speech amplifier is conventional and includes a dual input circuit with a switch to select either low-impedance input for a dynamic microphone or pickup, or high-impedance input from a crystal microphone or pickup. The second stage uses a 6SJ7 tube operating with shunt feedback from the plate of the 6SH7 amplifier-clipper. The incorporation of the feedback loop

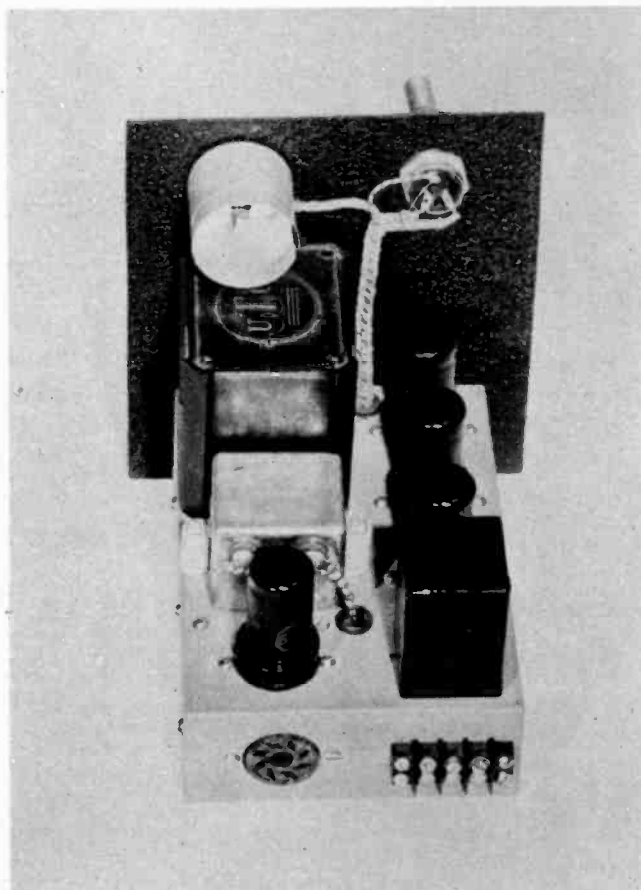

Figure 14.

REAR VIEW OF THE AMPLIFIER.

The dynamic microphone input transformer (multiple-shielded cast-case variety to reduce inductive hum pickup from the receiver and other equipment on the operating desk) is at the front left of the chassis. The small output transformer is at the lower right.

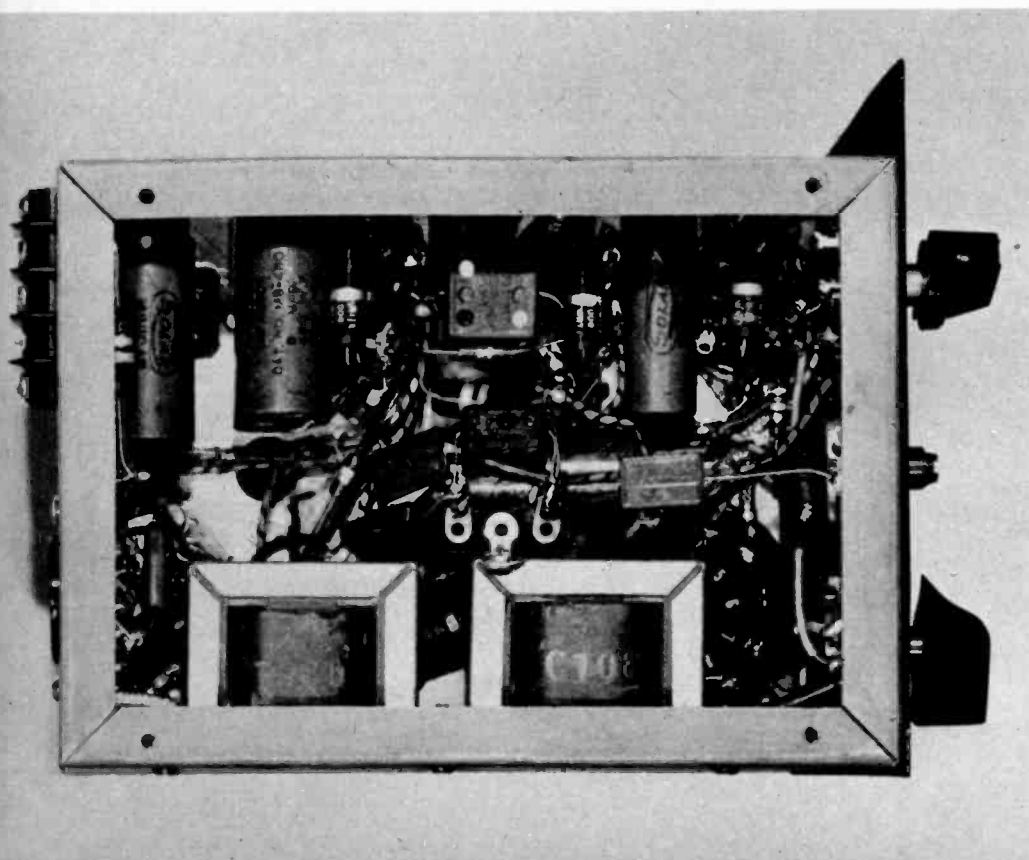

Figure 15.

UNDERCHASSIS VIEW OF THE SPEECH AMPLIFIER.

The two chokes in the filter network can be seen mounted on one wall of the chassis.

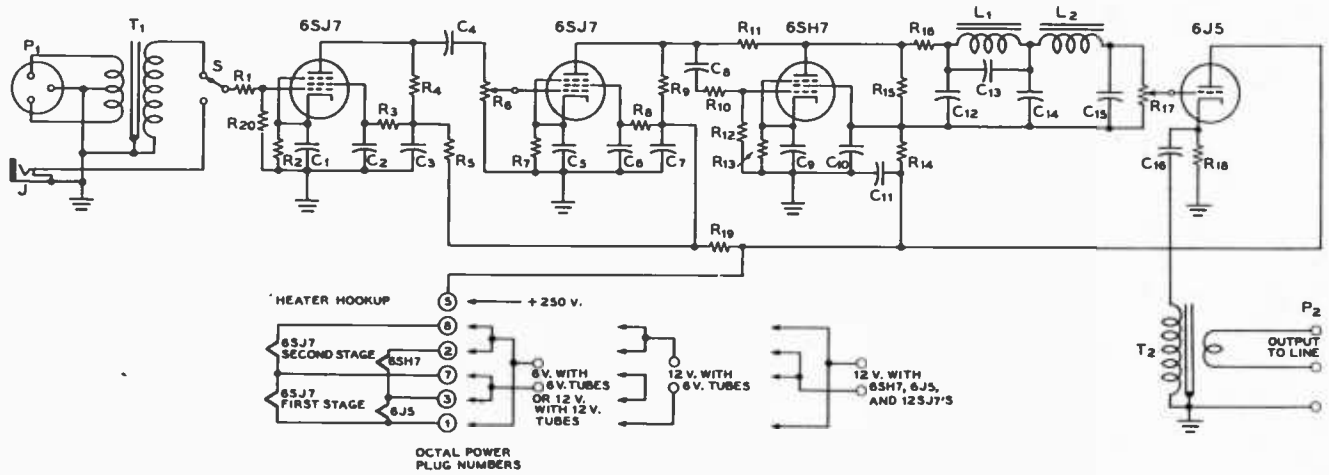

Figure 16.

SCHEMATIC DIAGRAM OF THE CLIPPER-FILTER SPEECH AMPLIFIER.

- | | | | |
|---|---|---|--|
| C ₁ —25- μ fd. 25-volt elect. | C ₁₀ —8- μ fd. 450-volt elect. | R ₁ —470,000 ohms $\frac{1}{2}$ watt | R ₁₀ —100,000 ohms $\frac{1}{2}$ watt |
| C ₂ —0.5- μ fd. 400-volt bathtub
(Can also contain C ₃) | C ₁₁ —0.003- μ fd. midget mica | R ₂ —47,000 ohms $\frac{1}{2}$ watt | R ₁₁ —100,000-ohm potentiometer |
| C ₃ —1.0- μ fd. 400-volt bathtub | C ₁₂ —200- μ fd. silver mica | R ₃ —1.0-megohm potentiometer | R ₁₂ —10,000 ohms 2 watts |
| C ₄ —0.003- μ fd. midget mica | C ₁₃ —175- μ fd. silver mica | R ₄ —1000 ohms 2 watts | R ₁₃ —22,000 ohms 2 watts |
| C ₅ —0.5- μ fd. 400-volt bathtub | C ₁₄ —500- μ fd. silver mica | R ₅ —1.0 megohm $\frac{1}{2}$ watt | R ₁₄ —1.0 megohm $\frac{1}{2}$ watt |
| C ₆ —25- μ fd. 25-volt elect. | C ₁₅ —330- μ fd. silver mica | R ₆ —220,000 ohms $\frac{1}{2}$ watt | R ₁₅ —15,000 ohms 2 watts |
| C ₇ —0.5- μ fd. 400-volt bathtub
in same can as C ₃ | C ₁₆ —8- μ fd. 450-volt elect. | R ₇ —47,000 ohms $\frac{1}{2}$ watt | |
| C ₈ —8- μ fd. 450-volt elect. | R ₁₇ —470 ohms 2 watts | R ₈ —1800 ohms 2 watts | |
| C ₉ —0.003- μ fd. midget mica | R ₁₈ —22,000 ohms 2 watts | R ₉ —2.2 megohms $\frac{1}{2}$ watt | |
| C ₁₀ —25- μ fd. 25-volt elect. | | | |

makes the overall characteristic of the amplifier very linear up to the point of clipping.

The filter circuit is conventional using an input section with $m = 0.6$ followed by a constant k section. Standard chokes (Stancor C-1080) are used as the inductors in the filter sections. The operation and design of electric wave filters is discussed in detail in Chapter 2, Section 2-9.

The output stage is a 6J5 cathode follower operating into a standard plate-to-line transformer so as to obtain the very best possible phase characteristic. Through the use of a cathode follower in the output coupling circuit there is substantially uniform phase shift from the clipper to the 500 ohm line output of the unit. When a large amount of clipping is in use square waves with flat tops and smoothly rounded edges appear across the 500-ohm line output of the unit. Hence adjustment on the transmitter following the clipper filter speech amplifier may be made in an effort to keep the overall phase characteristic uniform with assurance that the phase

characteristic of the audio system up to the line output terminals of the pre-amplifier is adequately good.

An octal receptacle is used on the back of the unit to bring in filament current and plate voltage of the unit from an external power supply. As a convenience the heaters of the tubes in the unit are brought out in such a manner that with 6-volt or 12-volt heater supply either 6-volt or 12-volt tubes or combinations of tube types may be used in the amplifier. The power drain from the 250 volt plate supply is approximately 20 Ma.

The front end of this speech amplifier may be used to drive directly a higher-power amplifier instead of feeding the 6J5 cathode-follower stage. If the front end is to be used in this application, approximately 20 volts peak is available from potentiometer R₁₁. The output circuit might consist of a pair of 6L6's or 6B4-G's with a phase inverter voltage amplifier ahead of the output stage and about a 5-to-1 attenuator between the slider arm of R₁₁ and the grid of the first tube in the phase inverter.

Power Supplies

ANY device which incorporates vacuum tubes requires a power supply for the filament and plate circuits of the tube or tubes. The filaments of the tubes must be heated in order to produce a source of electrons; direct-current voltages are needed for the other electrodes in order to obtain detection, amplification, and oscillation.

25-1 Rectification

Either a-c or d-c voltage may be used for filament power supply in most applications; however, the a-c power supply is the more economical and can be used with most tubes without introduction of hum in the output of the vacuum-tube device. The plate potential in most cases must be secured from a d-c source, such as from batteries or from a rectified and filtered a-c power supply.

First the a-c must be converted into a unidirectional current; this is accomplished by means of a *rectifier* of either the *full-wave* or *half-wave* type.

Half-Wave Rectifiers A half-wave rectifier passes one half of the wave of each cycle of the alternating current and blocks the other half. The output current is of a *pulsating* nature, which can be smoothed into pure, direct current by means of *filter* circuits. Half-wave rectifiers produce a pulsating current which has zero output during one half of each a-c cycle; this makes it difficult to filter the output properly into d-c and also to secure good voltage regulation for varying loads.

Full-Wave Rectifiers A full-wave rectifier consists of a pair of half-wave rectifiers working on opposite halves of the cycle, connected in such a manner that each half of the rectified a-c wave is combined in the output as shown in Figure 1. This pulsating unidirectional current can be filtered to any desired degree, depending upon the particular application for which the power supply is designed.

A full-wave rectifier may consist of two plates and a filament, either in a single glass or metal envelope for low-voltage rectification or in the form of two separate tubes, each having a single plate and filament for high-voltage rectification. The plates are connected across the high-voltage a-c power transformer winding, as shown in Figure 2B. The power trans-

former is for the purpose of transforming the 110-volt a-c line supply to the desired secondary a-c voltages for filament and plate supplies. The transformer delivers alternating current to the two plates of the rectifier tube; one of these plates is positive at any instant during which the other is negative. The center point of the high-voltage transformer winding is usually grounded and is, therefore, at zero voltage, thereby constituting the *negative B connection*.

While one plate of the rectifier tube is conducting, the other is inoperative, and vice versa. The output voltages from the rectifier tubes are connected together through a common rectifier filament circuit, and thus the plates alternately supply pulsating current to the output (load) circuit. The rectifier tube filaments are always positive in polarity with respect to the output in this type circuit.

The output current pulsates 120 times per second for a full-wave rectifier connected to a 60-cycle a-c line supply, and the output from the rectifier must connect to a *filter*, which will smooth the pulsations into direct current. Filters are designed to select or reject alternating currents; those most commonly used in a-c power supplies are of the *low-pass* type. This means that pulsating currents which have a frequency below the cut-off frequency of the filter will pass through the filter to the load. Direct current can be considered as alternating current of zero frequency; this passes through the low-pass filter. The 120-cycle pulsations are similar to alternating current in characteristic, so that the filter must be designed to have a *cutoff* at a frequency *lower than 120 cycles* (for a 60 cycle a-c supply).

Bridge Rectification The bridge rectifier (Figure 2C) is a type of full-wave circuit in which four rectifier elements or tubes are operated from a single high-voltage winding on the power transformer.

While twice as much output voltage can be obtained from a bridge rectifier as from a center-tapped circuit, the permissible output current is only one-half as great for a given power transformer. In the bridge circuit, four rectifiers and three filament heating transformer windings are needed, as against two rectifiers and one filament winding in the center-tapped full-wave circuit. In a bridge rectifier circuit, the inverse peak voltage impressed on any one rectifier tube is halved, which

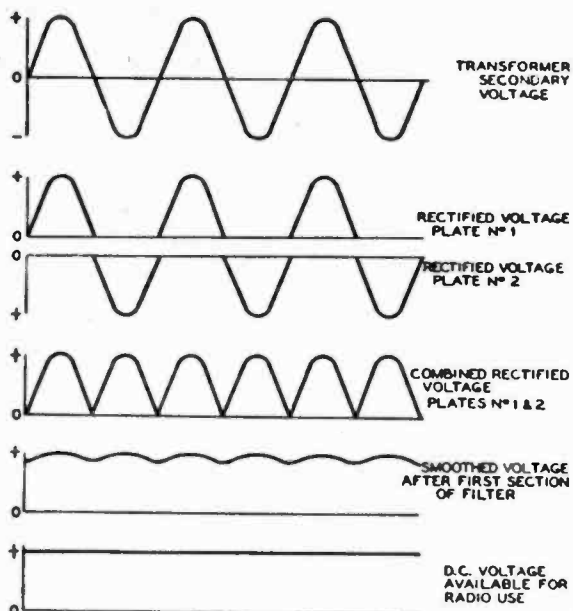

Figure 1.
FULL-WAVE RECTIFICATION.
Showing effects of rectification and addition of the outputs of the two rectifier tubes.

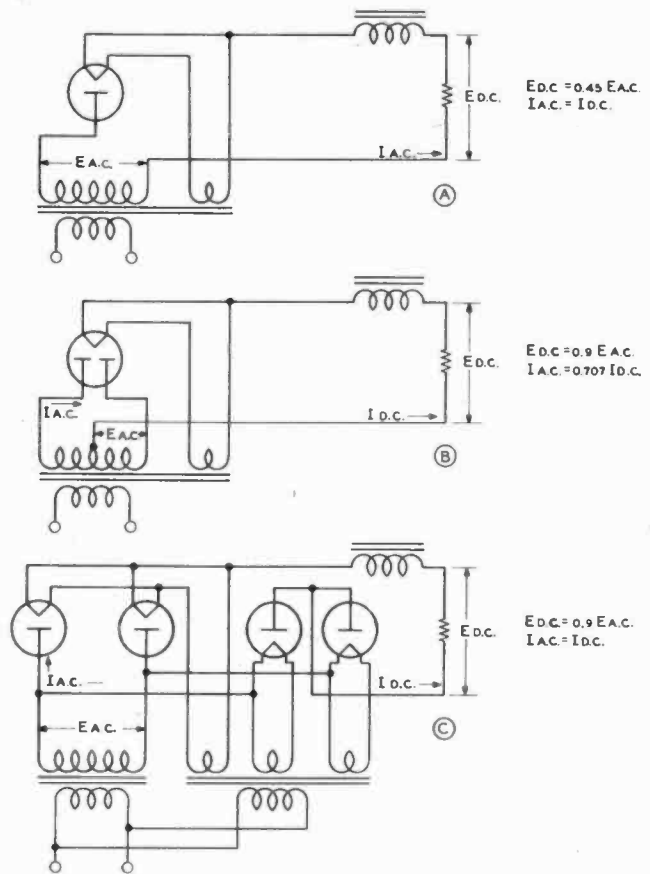

Figure 2.
SINGLE-PHASE RECTIFICATION CIRCUITS.
(A) shows a half-wave rectification circuit, (B) shows a full-wave rectification circuit, and (C) shows the common arrangement for bridge rectification. In the case of each circuit, operating with choke-input filter, the relationship between the a-c and d-c voltages and currents is given.

means that tubes of lower peak voltage rating may be used for a given voltage output.

Special Single-Phase Rectification Circuits

Figure 3 shows five circuits which may prove valuable when it is desired to obtain more than one output voltage from one plate transformer or where some special combination of voltages is required. Figure 3A shows a more or less common method for obtaining full voltage and half voltage from a bridge rectification circuit. With this type of circuit separate input chokes and filter systems should be used on both output voltages. If a transformer designed for use with a full-wave rectifier is used in this circuit, the current drain from the full-voltage tap is doubled and added to the drain from the half-voltage tap to determine whether the rating of the transformer is being exceeded. Thus if the transformer is rated at 1250 volts at 500 ma. it will be permissible to pull 250 ma. at 2500 volts with no drain from the 1250-volt tap, or the drain from the 1250-volt tap may be 200 ma. if the drain from the 2500-volt tap is 150 ma., and so forth.

Figure 3B shows a system which may be convenient for obtaining two voltages which are not in a ratio of 2 to 1 from a bridge-type rectifier; a transformer with taps along the winding is required for the circuit however. With the circuit arrangement shown the voltage from the tap will be greater than one-half the voltage at the top. If the circuit is changed so that the plates of the two rectifier tubes are connected to the outside of the winding instead of to the taps, and the cathodes of the other pair are connected to the taps instead of to the outside, the total voltage output of the rectifier will be the same, but the voltage at the tap position will be less than half the top voltage.

An interesting variable-voltage circuit is shown in Figure 3C. The arrangement may be used to increase or decrease the output voltage of a conventional power supply, as represented by transformer T_1 , by adding another filament transformer to isolate the filament circuits of the two rectifier tubes and adding another plate transformer between the filaments of the two tubes. The voltage contribution of the added transformer T_2 may be subtracted from or added to the voltage produced

by T_1 , simply by reversing the double-pole double-throw switch S. A serious disadvantage of this circuit is the fact that the entire secondary winding of transformer T_1 must be insulated for the total output voltage of the power supply.

An arrangement for operating a full-wave rectifier from a plate transformer not equipped with a center tap is shown in Figure 3D. The two chokes L_1 must have high inductance ratings at the operating current of the plate supply since the total peak voltage output of the plate transformer is impressed across the chokes alternately. However the chokes need only have half the current rating of the filter choke L_2 for a certain current drain from the power supply since only half the current passes through each choke. Also, the two chokes L_1 act as input chokes so that an additional swinging choke is not required for such a power supply.

A conventional two-voltage power supply with grounded transformer center tap is shown in Figure 3E. The output voltages from this circuit are separate and not additive as in the circuit of Figure 3B. Figure 3F is of advantage when it is desired to operate Class B modulators from the half-voltage output of a bridge power supply and the final amplifier from the full voltage output. Both L_1 and L_2 should be swinging chokes but the total drain from the power supply passes through L_1 while only the drain of the final amplifier passes through L_2 . Capacitors C_1 and C_2 need be rated at only half the maximum output voltage of the power supply, plus the usual safety factor. This arrangement is also of advantage in holding down the "key-up" voltage of a c-w transmitter since

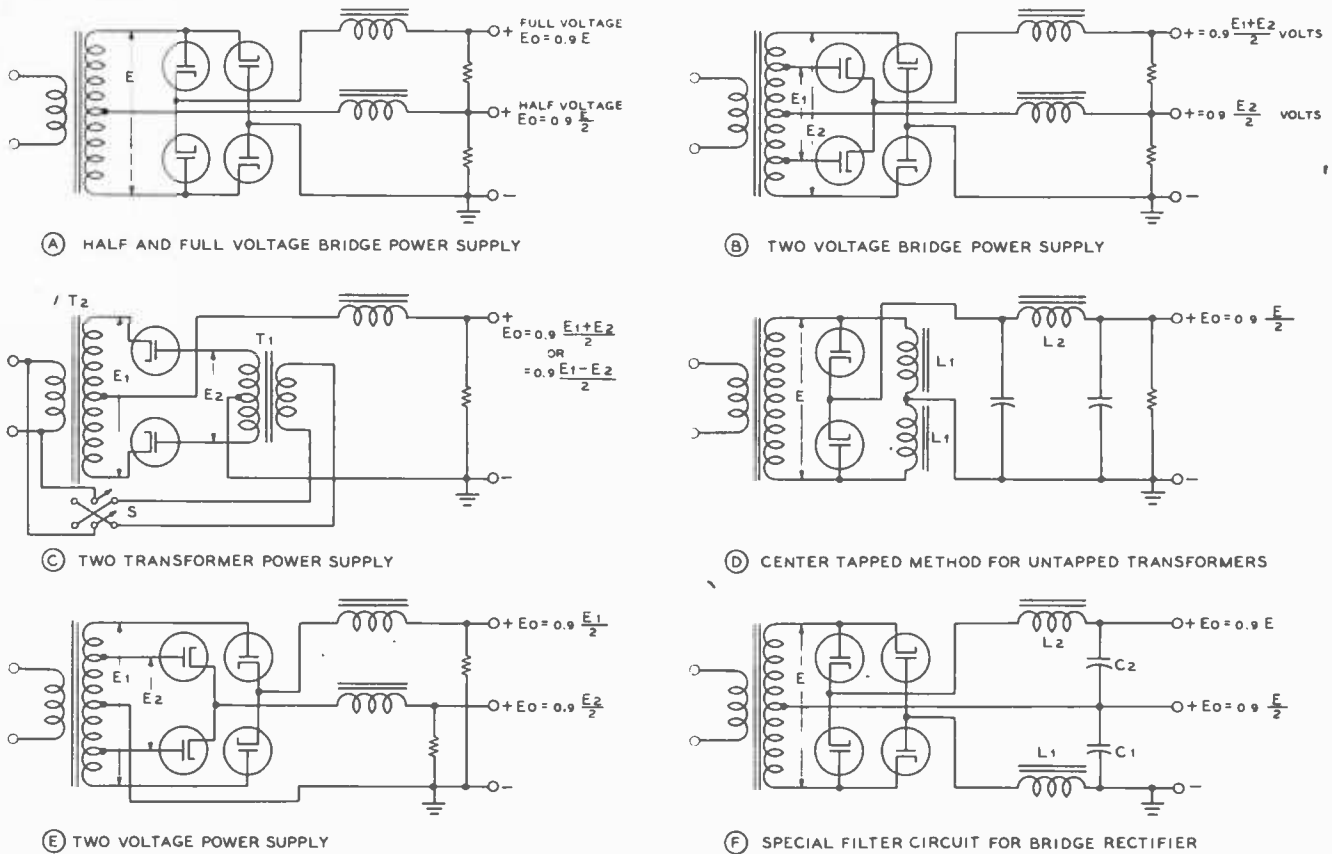

Figure 3.

SPECIAL SINGLE-PHASE RECTIFICATION CIRCUITS.

A description of the application and operation of each of these special circuits is given in the accompanying text.

both L_1 and L_2 are in series, and their inductances are additive, insofar as the "critical inductance" of a choke-input filter is concerned. If 4 μ fd. capacitors are used at both C_1 and C_2 adequate filter will be obtained on both plate supplies for hum-free radiophone operation.

Polyphase Rectification Circuits It is usual practice in commercial equipment installations when the power drain from a plate supply is to be greater than about one kilowatt to use a polyphase rectification system. Such power supplies offer better transformer utilization, less ripple output, and better power factor in the load placed upon the a-c line. However, such systems require a source of three-phase (or two-phase) energy. Several of the more common polyphase rectification circuits with their significant characteristics are shown in Figure 4. The increase in ripple frequency and decrease in percentage of ripple is apparent from the figures given in Figure 4. The circuit of Figure 4C gives the best transformer utilization as does the bridge circuit in the single-phase connection. The circuit has the further advantage that there is no average d-c flow in the transformer. A tap at half-voltage may be taken at the junction of the star secondaries, but there will be d-c flow in the transformer secondaries with the power supply center tap in use.

Rectifiers Rectifying elements in high-voltage plate supplies are almost invariably electron tubes of either the high-vacuum or mercury-vapor type, although selenium rectifier stacks containing a large number of elements are sometimes used. Low-voltage high-current supplies may use argon gas rectifiers (Tungar tubes), selenium rectifiers, or other types of dry-disc rectification elements. The recently intro-

duced *xenon* rectifier tubes offer some advantage over mercury-vapor rectifiers for high-voltage applications where extreme temperature ranges are likely to be encountered. However, such rectifiers (3B25 for example) are considerably more expensive than their mercury-vapor counterparts.

Peak Inverse Plate Voltage and Peak Plate Current In an a-c circuit, the maximum peak voltage or current is $\sqrt{2}$ or 1.41 times that indicated by the a-c meters in the circuit. The meters read the *root-mean-square* (r.m.s.) values, which are the peak values divided by 1.41 for a sine wave.

If a potential of 1,000 r.m.s. volts is obtained from a high-voltage secondary winding of a transformer, there will be 1,410-volts peak potential from the rectifier plate to ground. The rectifier tube has this voltage impressed on it, either positively when the current flows or "inverse" when the current is blocked on the other half-cycle. The *inverse peak voltage* which the tube will stand safely is used as a rating for rectifier tubes. At higher voltages the tube is liable to arc back, thereby destroying it. The relations between peak inverse voltage, total transformer voltage and filter output voltage depend upon the characteristics of the filter and rectifier circuits (whether full- or half-wave, bridge, etc.).

Rectifier tubes are also rated in terms of *peak plate current*. The actual direct load current which can be drawn from a given rectifier tube or tubes depends upon the type of filter circuit. A full-wave rectifier with capacitor input passes a peak current several times the direct load current.

In a filter with choke input, the peak current is not much greater than the load current if the inductance of the choke is fairly high (assuming full-wave rectification).

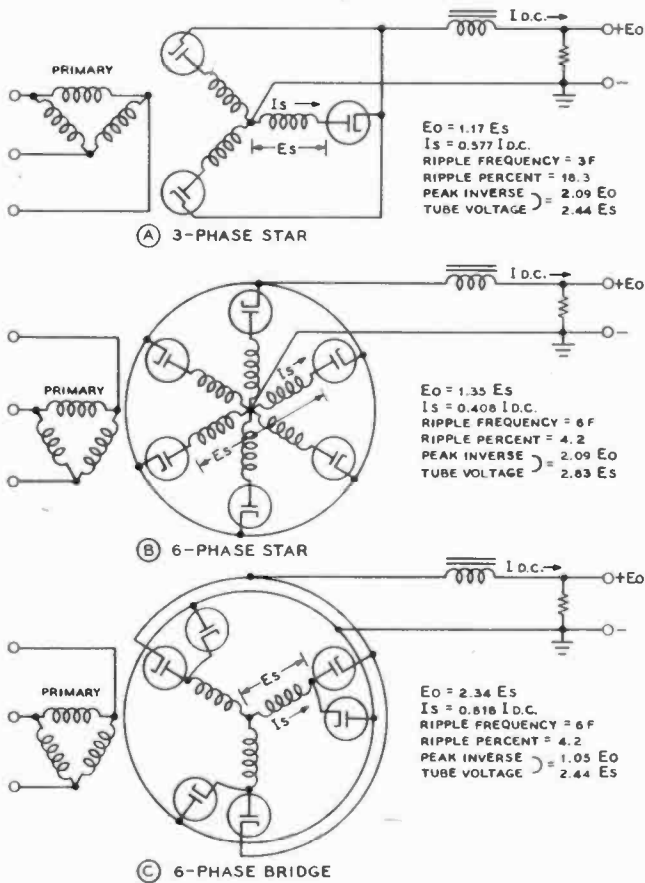

Figure 4.

COMMON POLYPHASE-RECTIFICATION CIRCUITS.

These circuits are best applied when polyphase power is available for the plate power supply of a high-power transmitter. The circuits are described in the accompanying text.

A full-wave rectifier with two rectifier elements requires a transformer which delivers twice as much a-c voltage as would be the case with a half-wave rectifier or bridge rectifier.

Mercury-Vapor Rectifier Tubes The inexpensive mercury-vapor type of rectifier tube is almost universally used in the high-voltage plate supplies of amateur transmitters. Most amateurs are quite familiar with the use of these tubes but it should be pointed out that when new or long-unused mercury-vapor tubes are first placed in service, the filaments should be operated at normal temperature for approximately twenty minutes before plate voltage is applied, in order to remove all traces of mercury from the cathode and to clear any mercury deposit from the top of the envelope. After this preliminary warm-up with a new tube, plate voltage may be applied within 20 to 30 seconds after the time the filaments are turned on, each time the power supply is used. If plate voltage should be applied before the filament is brought to full temperature, active material may be knocked off the oxide-coated filament and the life of the tube will be greatly shortened.

Small r-f chokes must sometimes be connected in series with the plate leads of mercury-vapor rectifier tubes in order to prevent the generation of radio-frequency hash. These r-f chokes must be wound with sufficiently heavy wire to carry the load current and must have enough inductance to attenuate the r-f parasitic noise current to prevent it from flowing in the filter supply leads and then being radiated into nearby receivers. Manufactured mercury-vapor rectifier hash chokes are available in various current ratings from the James Millen

Manufacturing Company in Malden, Mass., and from the J. W. Miller Company in Los Angeles.

When mercury-vapor rectifier tubes are operated in parallel in a power supply, small resistors or small iron-core choke coils should be connected in series with the plate lead of each tube. These resistors or inductors tend to create an equal division of plate current between parallel tubes and prevent one tube from carrying the major portion of the current. When high vacuum rectifiers are operated in parallel, these chokes or resistors are not required.

25-2 Filter Circuit Considerations

The filter circuit for a conventional power supply consists of a low-pass section whose cut-off frequency is somewhat lower than the minimum ripple frequency to be expected from the power supply. A low-pass filter consists of combinations of inductances and capacitances. An inductor or *choke coil* offers an impedance to any change in the current flowing through it. A high-inductance choke coil offers a relatively high impedance to the flow of pulsating current, with the result that the a-c component or ripple passes from the rectifier tube through the inductor to the load only with the greatest of difficulty. Capacitance has exactly the opposite action to that of inductance. It offers a low impedance path to the flow of alternating or pulsating current but presents practically infinite impedance to the flow of direct current. In a low-pass filter, the inductance coils are connected in series with the output of the rectifier while capacitors are connected in parallel across the output circuit of the rectifier. A simple filter circuit of the choke input type is illustrated in Figure 5.

An electric current always follows the path of least resistance or impedance. The direct-current component of the rectifier output will travel through the choke coil L and back to the return circuit through the external load which normally consists of the plate circuits of vacuum tubes. The a-c component of the rectifier output, however, tends to be impeded by the choke and short-circuited by the parallel capacitors so that the amount of alternating current at the output of the filter is very much less than that at the input. The *load impedance* across the output of the conventional filter system will generally fall in the range from 2,000 to 20,000 ohms. The value of this effective resistance may be calculated by dividing the output voltage of the filter system by the total load current. The value of the load impedance is necessary in making calculations concerning the critical inductance of the input choke for a filter circuit.

Filter Input Circuits There are two types of input circuits which may be used in filter systems. These are capacitor-input sections and inductor or choke-input sections. The capacitor-input filter is commonly used in low voltage power supplies where the drain such as from a receiver will be relatively constant but is seldom used in power supplies

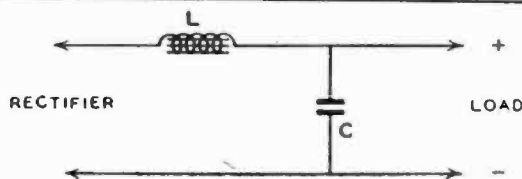

Figure 5.

SINGLE-SECTION CHOKE-INPUT FILTER.

With commonly used values of L and C, the ripple voltage will be between 3 and 10 percent of the d-c output voltage depending upon the actual values used in the filter and upon the load resistance. This type of filter is commonly used in supplying plate voltage to a push-pull modulator stage (in which most of the plate-supply ripple cancels out) or to a c-w telegraphy amplifier in which a small amount of ripple may be tolerated.

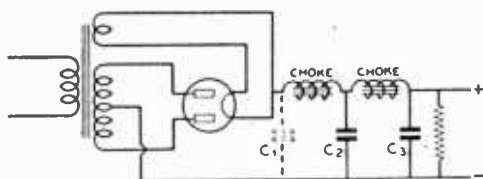

Figure 6.
STANDARD 2-SECTION FILTER.

When C_1 is used in the circuit the filter is termed "capacitor input." If C_1 is omitted the filter is called "choke input."

delivering more than perhaps 800 volts. Capacitor-input filters are characterized by relatively poor regulation, poor power factor of the line current drain, a high ratio of r.m.s. to average transformer-winding current and a high peak current flow in the rectifier tubes. The permissible current drain from a high-voltage power supply using a capacitor-input filter is only about one-half that of the same power supply when using a choke-input filter. Also, the no-load output voltage from a capacitor-input filter tends to approach the peak voltage output of the plate transformer, or 1.41 times the active r.m.s. secondary voltage. At high current drain the output d-c voltage from such a filter will be less than the r.m.s. secondary voltage, thus making for poor regulation in the power supply. These two standard power supply filter-input circuits are shown in Figure 6.

The choke-input filter system, on the other hand, tends to keep the output voltage of the filter at approximately 0.9 of the r.m.s. voltage impressed upon the rectifier tubes from the power transformer. However, this regulating effect does not take place until the load current exceeds a certain minimum value. In other words, as the load current is decreased, at a certain critical point the output voltage begins to soar. This point is determined by the inductance of the input choke. If it has high inductance, the current can be reduced to a very low value before the output voltage begins to rise. Under these conditions, a low-drain bleeder resistor will keep the current in excess of the critical point, and the voltage will not soar even if the external load is removed.

The minimum inductance which will be required for the input choke is called the *critical inductance* and is expressed by the following equation:

$$L_{crit.} = \frac{R_L}{1000}$$

where $L_{crit.}$ is the critical inductance of the input choke and R_L is the effective load resistance of the power supply. When all the load is removed from the power supply, as with excitation keying of a c-w transmitter, R_L is equal to the bleeder resistance across the power supply. When the power supply is feeding a variable load whose current does not drop completely to zero, R_L is equal to the normal voltage output of the supply divided by the minimum load current. As an example, if a 2000-volt power supply with a 50,000-ohm bleeder is to be used to feed a pair of 810 modulator tubes operating with the rated 50 volts of bias, the minimum drain for the supply will be 60 ma. minimum drain by the 810's plus 40 ma. drain through the bleeder. Thus the total minimum drain is 100 ma. at 2000 volts so the value of R_L at this drain is 2000 divided by 0.1 ampere or 20,000 ohms. Hence we see, by use of the critical inductance equation, that a minimum value of 20 henrys will be required for the input choke.

Inductors are made especially for use as input chokes with little or no air gap in order to give them more inductance at low values of current. Their filtering effectiveness at maximum current is impaired somewhat, because they saturate easily, but their high inductance at low values of current permits use of a smaller bleeder to keep the current in excess of the critical

value. Such chokes are called *swinging chokes* because they have high initial inductance and the inductance rapidly falls to a comparatively low value as the current through the choke is increased.

Filter Choke Coils Filter inductors consist of a coil of wire wound on a laminated iron core. The size of wire is determined by the amount of direct current which is to flow through the choke coil. This direct current magnetizes the core and reduces the inductance of the choke coil; therefore, filter choke coils of the "smoothing" type are built with an air gap of a small fraction of an inch in the iron core, for the purpose of preventing saturation when maximum d.c. flows through the coil winding. The "air gap" is usually in the form of a piece of fiber inserted between the ends of the laminations. The air gap reduces the initial inductance of the choke coil, but keeps it at a higher value under maximum load conditions. The coil must have a great many more turns for the same initial inductance when an air gap is used.

The d-c resistance of any filter choke should be as low as possible in conjunction with the desired value of inductance. Small filter chokes, such as those used in radio receivers, usually have an inductance of from 6 to 15 henrys, and a d-c resistance of from 200 to 400 ohms. A high d-c resistance will reduce the output voltage, due to the voltage drop across each choke coil. Large filter choke coils for radio transmitters and Class B amplifiers usually have less than 100 ohms d-c resistance.

Filter Capacitors There are two types of filter capacitors: (1) paper dielectric type, (2) electrolytic type.

Paper capacitors consist of two strips of metal foil separated by several layers of waxed paper. Some types of paper capacitors are wax-impregnated, but the better ones, especially the high-voltage types, are oil-impregnated and oil-filled. Capacitors are rated both for *flash* test and normal operating voltages; the latter is the important rating and is the maximum voltage which the capacitor should be required to withstand in service.

The capacitor across the rectifier circuit in a capacitor-input filter should have a working voltage rating equal to at least 1.41 times the r.m.s. voltage output of the rectifier. The remaining capacitors may be rated more nearly in accordance with the d-c voltage.

Electrolytic capacitors are of two types: (1) wet, (2) dry. The wet electrolytic capacitor consists of two aluminum electrodes immersed in a solution called an *electrolyte*. A very thin film of oxide is formed on the surface of one electrode, called the *anode*. This acts as the dielectric. The electrolytic capacitor must be correctly connected in the circuit so that the anode always is at positive potential with respect to the electrolyte, the latter actually serving as the other electrode (plate) of the capacitor. A reversal of the polarity for any length of time will ruin the capacitor.

The dry type of electrolytic capacitor uses an electrolyte in the form of paste. The dielectric in both kinds of electrolytic capacitors is not perfect; these capacitors have a much higher direct current leakage than the paper type. The leakage current is greater in the wet electrolytic than in the dry types, but the former are self-healing and are not permanently damaged by moderate voltage overloads.

The high capacitance of electrolytic capacitors results from the thinness of the film which is formed on the plates. The maximum voltage that can be safely impressed across the average electrolytic filter capacitor is between 450 and 600 volts; the working voltage is usually rated at 450. When electrolytic capacitors are used in filter circuits of high-voltage supplies, the capacitors should be connected in series. The

positive terminal of one capacitor must connect to the negative terminal of the other, in the same manner as dry batteries are connected in series.

It is not necessary to connect shunt resistors across each electrolytic capacitor section as it is with paper capacitors connected in series, because electrolytic capacitors have fairly low internal d.c. resistance as compared to paper capacitors. Also, if there is any variation in resistance, it is that electrolytic unit in the poorest condition which will have the highest leakage current, and therefore the voltage across this capacitor will be lower than that across one of the series connected units in better condition and having higher internal resistance. Thus we see that equalizing resistors are not only unnecessary across series-connected electrolytic capacitors but are actually undesirable. This assumes, of course, similar capacitors by the same manufacturer and of the same capacitance and voltage rating. It is *not advisable* to connect in series electrolytic capacitors of different make or ratings.

There is very little economy in using electrolytic capacitors in series in circuits where more than two of these capacitors would be required to prevent voltage breakdown.

Wet electrolytic capacitors housed in an aluminum can ordinarily use the can as the negative electrode, or contact to the electrolyte (the electrolyte being the true electrode). Wet electrolytic capacitors should always be mounted in a vertical position. To allow escape of gas generated as a result of electrolysis, a small vent is provided.

Electrolytic capacitors can be greatly reduced in size by use of etched aluminum foil for the anode. This greatly increases the surface area, and the dielectric film covering it, but raises the power factor slightly. For this reason, ultra-midget electrolytic capacitors should not be used at full rated d-c voltage when a high a-c component is present, such as would be the case for the input capacitor in a capacitor-input filter.

When a dry (paste electrolyte) electrolytic capacitor is subjected to over voltage and the leakage current is increased substantially, the capacitor may be considered as no longer fit for service, as heating caused by the rupture will aggravate the condition. As previously mentioned, mildly ruptured *wet* electrolytic capacitors will heal if normal voltage is applied to them for a time.

Bleeder Resistors A heavy-duty resistor should be connected across the output of a filter in order to draw some load current at all times. This resistor avoids soaring of the voltage at no load when swinging choke input is used, and also provides a means for discharging the filter capacitors when no external vacuum-tube circuit load is connected to the filter. This *bleeder* resistor should normally draw approximately 10 per cent of the full load current.

The power dissipated in the bleeder resistor can be calculated by dividing the square of the d-c voltage by the resistance. This power is dissipated in the form of heat, and, if the resistor is not in a well-ventilated position, the wattage rating should be higher than the actual wattage being dissipated. High voltage, high capacitance filter capacitors can hold a dangerous charge if not bled off, and wire-wound resistors occasionally open up without warning. Hence it is wise to place carbon resistors in series across the regular wire-wound bleeder as explained in Chapter 9 under *Safety Precautions*.

When purchasing a bleeder resistor, be sure that the resistor will stand not only the required wattage, but also the *voltage*. Some resistors have a voltage limitation which makes it impossible to force sufficient current through them to result in rated wattage dissipation. This type of resistor usually is provided with slider taps, and is designed for voltage divider service. An untapped, non-adjustable resistor is preferable as a high voltage bleeder, and is less expensive. Several small

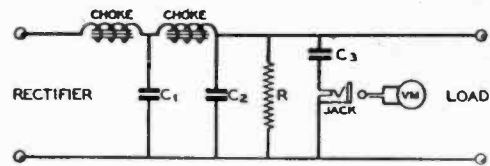

Figure 7.
CIRCUIT FOR MEASURING A-C RIPPLE.

The a-c instrument should not be inserted into the jack until after the plate supply has been turned on; otherwise the charging current to capacitor C_3 will damage the instrument. The jack must be of the closed-circuit type. C_3 must be rated at somewhat more than the plate supply voltage to afford a factor of safety. Further, the meter must be removed from the circuit before the plate supply is turned off or the discharge current of C_3 may damage the instrument.

resistors may be used in series, if desired, in order to obtain the required wattage and voltage rating.

Output Voltage from a Power Supply An estimate of the output voltage which will be obtained from a power supply using mercury-vapor rectifier tubes and an input

choke equal to or greater than the critical inductance is quite easily made. The output voltage will be approximately equal to 0.9 times the actual r.m.s. half-secondary voltage in a full-wave rectifier (0.9 times the full secondary voltage in a bridge rectifier) less the IR drops in the choke coils. If 0.9 times the half-secondary voltage in a full-wave rectifier is equal to 2100 volts, the current drain is 300 ma. and the total resistance of the input choke and the filter choke is 200 ohms, the output voltage will be 2100 minus 0.3 amperes times 200 ohms or 60 volts, or a net voltage of 2040.

Ripple Voltage Measurement The ripple in the output of a filter circuit can be measured with an oscilloscope or by means of the simple circuit in Figure 7. A high-voltage capacitor C_3 , having a capacitance of from $\frac{1}{4}$ to 1 μ fd. and a high-resistance copper-oxide a-c voltmeter provides a method of measuring the actual *ripple voltage*.

The voltmeter should be plugged into the measuring jack after the power supply and external load circuit are in *normal operating condition*, and the meter should be removed from the shorting type jack before turning off the power supply or removing the load. The charging current through capacitor C_3 would soon burn out the meter if the meter were left in the circuit at all times.

25-3 Special Power Supplies

A complete transmitter usually includes one or more power supplies such as grid-bias packs, voltage-regulated supplies, or transformerless supplies having some special characteristic. Battery-operated power supplies have also been included under this grouping.

Glow-Discharge Voltage-Regulator Tubes

Where it is desired in a circuit to stabilize the voltage supply to a circuit requiring not more than perhaps 20 to 25 ma. the glow-discharge type of voltage-regulator tube can be used to great advantage. Examples of such circuits are the local oscillator circuit in a receiver, the tuned oscillator in a v.f.o., the oscillator in a frequency meter, or the bridge circuit in a vacuum-tube voltmeter. A number of tubes are available for this application including the OA3/VR75, OB3/VR90, OC3/VR105, OD3/VR150, and the OA2 and OB2 miniature types. These tubes stabilize the voltage across their terminals to 75, 90, 105, or 150 volts. The miniature types OA2 stabilize to 150 volts and OB2 to 108 volts. The types OA2, OB2, and OB3/VR90 have a maximum current rating of 30 ma. and the other three types have a

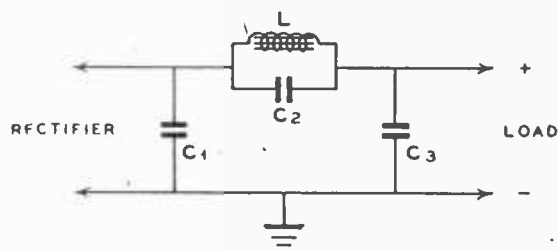

Figure 8.
TUNED FILTER CIRCUIT.

The capacitors C_1 and C_3 are the usual values which would be used with a conventional filter circuit. The value of C_2 is then adjusted to resonate the choke L to the main ripple frequency. Normal load current should be drawn from the power supply while this adjustment is being made so that the inductance of choke L will be at its usual value. This type of filter has very great attenuation to the main ripple frequency, but its attenuation to higher harmonics of the power supply frequency is less than with the conventional "brute force" filter. Hence it is advisable to precede a filter of this type with an input choke, or to follow the tuned filter with a section of conventional filter.

maximum current rating of 40 ma. The minimum current required by all six types to sustain a constant discharge is 5 ma.

A VR tube (common term applied to all glow-discharge voltage regulator tubes) may be used to stabilize the voltage across a variable load or the voltage across a constant load fed from a varying voltage. Two or more VR tubes may be connected in series to provide exactly 180, 210, 255 volts or other combinations of the voltage ratings of the tubes. It is not recommended, however, that VR tubes be connected in parallel since both the striking and the regulated voltage of the paralleled tubes will probably be sufficiently different so that only one of the tubes will light. The remarks following apply generally to all the VR types although some examples apply specifically to the OD3/VR150 type.

A device requiring, say, only 50 volts can be stabilized against *supply voltage* variations by means of a VR-105 simply by putting a suitable resistor in series with the regulated voltage and the load, dropping the voltage from 105 to 50 volts. However, it should be borne in mind that under these conditions the device will *not* be regulated for *varying load*; in other words, if the *load resistance* varies, the voltage across the load will vary, even though the regulated voltage remains at 105 volts.

To maintain constant voltage across a *varying load resistance* there must be *no* series resistance between the regulator tube and the load. This means that the device must be operated exactly at one of the voltages obtainable by seriesing two or more similar or different VR tubes.

A VR-150 may be considered as a stubborn variable resistor having a range of from 30,000 to 5000 ohms and so intent upon maintaining a fixed voltage of 150 volts across its terminals that when connected across a voltage source having *very poor regulation* it will instantly vary its own resistance within the limits of 5000 and 30,000 ohms in an attempt to maintain the same 150 volt drop across its terminals when the supply voltage is varied. The theory upon which a VR tube operates is covered under the subject of gaseous conduction in the chapter on *Vacuum Tube Principles*, and will not be discussed here.

It is paradoxical that in order to do a good job of regulating, the regulator tube must be fed from a voltage source having poor regulation (high series resistance). The reason for this presently will become apparent.

If a high resistance is connected across the VR tube, it will not impair its ability to maintain a fixed voltage drop. How-

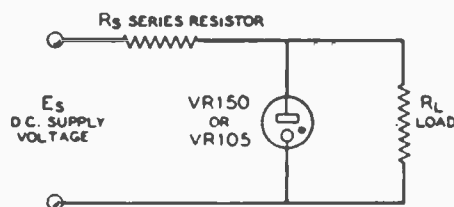

Figure 9.
STANDARD VR-TUBE REGULATOR CIRCUIT.

The VR-type regulator tube will maintain the voltage across its terminals constant within 1 or 2 volts for moderate variations of either R_L or E_s . See text for discussion of the application of the various VR-tube types.

ever, if the load is made too low, a variable 5000 to 30,000 ohm shunt resistance (the VR-150) will not exert sufficient effect upon the resulting resistance to provide constant voltage except over a *very limited* change in supply voltage or load resistance. The tube will supply maximum regulation, or regulate the largest load, when the source of supply voltage has high internal or high series resistance, because a variation in the effective internal resistance of the VR tube will then have more controlling effect upon the load shunted across it.

In order to provide greatest range of regulation, a VR tube (or two in series) should be used with a series resistor (to effect a poorly regulated voltage source) of such a value that it will permit the VR tube to draw from 8 to 20 ma. under normal or average conditions of supply voltage and load impedance. For maximum control range, the series resistance should be not less than approximately 20,000 ohms, which will necessitate a source of voltage considerably in excess of 150 volts. However, where the supply voltage is limited, good control over a *limited range* can be obtained with as little as 3000 ohms series resistance. If it takes less than 3000 ohms series resistance to make the VR tube draw 15 to 20 ma. when the VR tube is connected to the load, then the supply voltage is not high enough for proper operation.

Should the current through a VR-150, VR-105, or VR-75 be allowed to exceed 40 ma., the life of the tube will be shortened. If the current falls below 5 ma., operation will become unstable. Therefore, the tube must operate within this range, and within the two extremes will maintain the voltage within 1.5 per cent. It takes a voltage excess of at least 10 or 15 per cent to "start" a VR type regulator; and to insure positive starting each time the voltage supply should preferably exceed the regulated output voltage rating by about 20 per cent or more. This usually is automatically taken care of by the fact that if sufficient series resistance for good regulation is employed, the voltage impressed across the VR tube before the VR tube ionizes and starts passing current is quite a bit higher than the starting voltage of the tube.

When a VR tube is to be used to regulate the voltage applied to a circuit drawing *less than 15 ma.* normal or average current, the simplest method of adjusting the series resistance is to remove the load and vary the series resistor until the VR tube draws about 30 ma. Then connect the load, and that is all there is to it. This method is particularly recommended when the load is a heater type vacuum tube, which may not draw current for several seconds after the power supply is turned on. Under these conditions, the current through the VR tube will never exceed 40 ma. even when it is running unloaded (while the heater tube is warming up and the power supply rectifier has already reached operating temperature).

Figure 9 illustrates the standard glow discharge regulator tube circuit. The tube will maintain the voltage across R_L constant to within 1 or 2 volts for moderate variations in R_L or E_s .

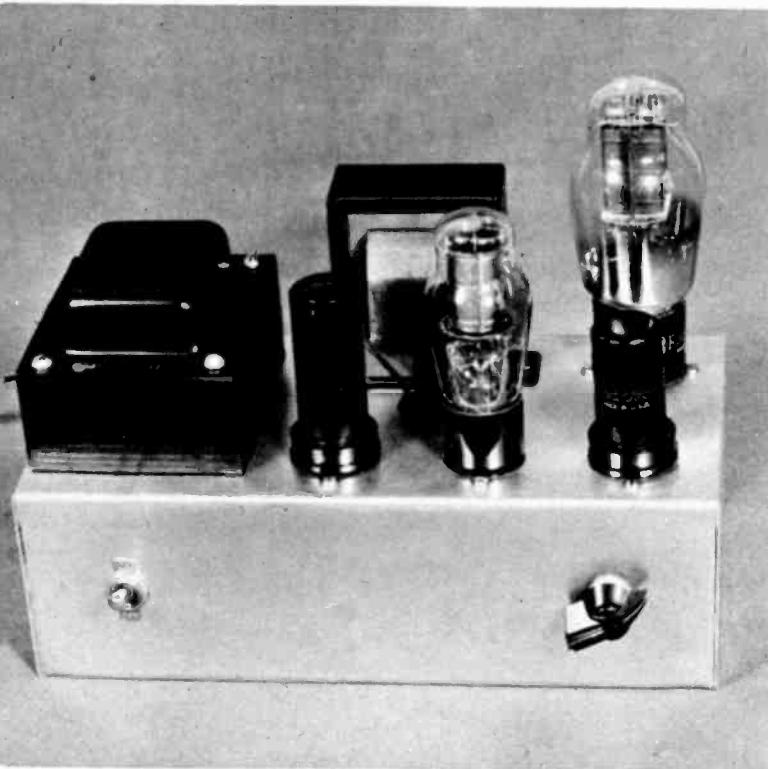

Figure 10.
VOLTAGE-REGULATED POWER SUPPLY.

This power pack is capable of delivering from 175 to 300 volts at an average current of 60 ma. with very good stability with respect to both load and supply-voltage variations.

Voltage-Regulated Power Supplies

When it is desired to stabilize the potential across a circuit drawing more than a few milliamperes, it is advisable to use a voltage regulated power supply of the type shown in Figures 10 and 11 rather than glow discharge type tubes. The power pack illustrated will deliver up to 300 volts of well-regulated voltage, the output voltage holding within 1 volt for variations in line voltage or load resistance of 25 per cent.

The maximum current that may be drawn from the supply without detrimentally affecting the regulation is determined by the desired output voltage, the latter being adjustable by variation of R_3 . At 200 volts the output voltage is constant up to 100 ma., the maximum current which the 6B4-G and power transformer will stand. At 300 volts, the maximum usable output voltage, the useful range is from 0 to 50 ma. At the latter voltage the regulator begins to lose control when more than 50 ma. is drawn from the supply.

The system works by virtue of the fact that the 6B4-G acts as a variable series resistance or loss, and is controlled by a regulator tube much in the manner of a v-c circuits or inverse feedback as used in radio receivers and a-f amplifiers. The 6SJ7 amplifier controls the bias on the 6B4-G, which in turn controls the resistance of the 6B4-G, which in turn controls the output voltage, which in turn controls the plate current of the 6SJ7, thus completing the cycle of regulation. It is readily apparent that under these conditions any change in the output voltage will tend to "resist itself," much as the a-v-c system of a receiver resists any change in signal strength delivered to the detector.

Because it is necessary that there always be a moderate voltage drop through the 6B4-G in order for it to have proper control, the rest of the power supply is designed to deliver as much output voltage as possible considering the r.m.s. voltage of the b.c.l. type power transformer. This calls for a low resistance full-wave rectifier, a high capacitance input capacitor, and a low resistance filter choke. A 5Z4 rectifier is used in place of an 83 or other mercury-vapor tube to avoid possible "hash" in any nearby receiver. This tube has lower resistance than an 80 or 5Z3 and in addition, since it is a heater type, plate voltage will not be applied to the regulator tubes until they are up to operating temperature.

Voltage-Regulated Bias Pack

The type of voltage-regulated power supply discussed in the previous paragraphs is not suited for use as a bias pack. Since the direction of current flow in a bias power supply is opposite from that of a regular power supply, a special type of pack must be used for bias service. A suitable pack for use in a regulated bias circuit is shown in Figure 12. In this type of power supply, the regulator tube (6B4-G, 2A3, or 6A3) acts as a variable bleeder resistor which automatically adjusts its resistance to a value such that the grid current flowing through it will develop a constant value of voltage across the output terminals of the pack.

Inspection of the circuit diagram of Figure 12 will show that the circuit consists of a half-wave power supply (to obtain greater voltage from the b.c.l.-type power transformer), a pair of electrolytic capacitors in series as the filter, and a tapped voltage divider feeding the grid of the 6B4-G regulator tube. The tap switch, S_2 , provides a rough voltage adjustment from about 100 to 600 volts, while the rheostat, R_1 , allows a fine voltage adjustment to be made. The maximum grid current which may be run through the pack is determined by the plate dissipation of the 6B4-G. The permissible grid current varies from about 100 ma. in the vicinity of 100 volts of bias down to about 25 ma. in the 600-volt region. The regulation of the supply is equivalent to a constant voltage in series with a 200-ohm resistor. If the supply is to be used as bias for a Class B modulator a 10- μ fd. electrolytic capacitor should be placed across the output.

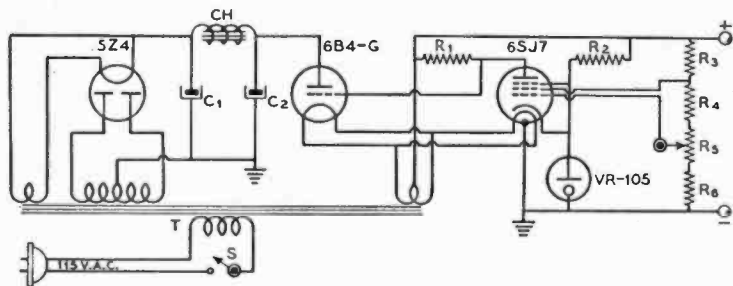

- C₁—8- μ fd. 600-volt electrolytic
- C₂—8- μ fd. 450-volt electrolytic
- R₁—500,000 ohms, 1/2 watt
- R₂—75,000 ohms, 1 watt
- R₃—10,000 ohms, 1 watt
- R₄—20,000 ohms, 1 watt
- R₅—15,000-ohm potentiometer
- R₆—10,000 ohms, 1 watt
- S—A.c. line switch
- T—700 v. c.t. 120 ma., 5 v. 4 a., 6.3 v. 4.7 a.
- CH—10-hy. 110-ma. choke

Figure 11.
SCHEMATIC OF THE VOLTAGE-REGULATED POWER SUPPLY.

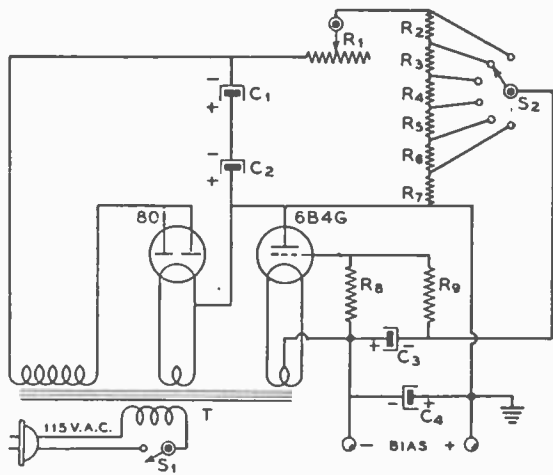

Figure 12.

VOLTAGE-REGULATED BIAS POWER SUPPLY.

- | | |
|---|---|
| C_1, C_2, C_3, C_4 —4- μ fd. 450-volt electrolytics | R_0 —10,000 ohms, 1/2 watt |
| R_1 —50,000-ohm potentiometer | S_1 —A.c. line switch |
| $R_2, R_3, R_4, R_5, R_6, R_7$ —50,000 ohms, 1/2 watt | S_2 —Voltage selector switch, s.p. 6-position |
| R_8 —100,000 ohms, 1/2 watt | T —480 v. c.t. 40 ma., 5 v. 2 a., 6.3 v. 2 a. |

Bias Pack for Cathode Metering Circuit

It is usually desirable in a high-power transmitter to meter the plate current of a stage in the cathode circuit. However, when power supply bias is used with a common return the grid current of the stage also shows on the cathode meter. The circuit shown in Figure 13 allows the use of a single bias pack on several r-f stages and also perhaps the Class B modulator yet returns the grid current of the stage directly to the cathode so that only the plate current shows on the cathode meter. Thus, in Figure 13, M_1 reads only the grid current on the Class C amplifier, M_2 reads only the plate current of this stage, and M_3 reads only the plate current of the Class B modulator.

Fixed-Minimum Bias Pack

Figure 14 shows a bias pack circuit for providing a fixed minimum value of bias for several amplifier stages. When no grid current is flowing on the amplifier stages the grid bias will be approximately equal to the output voltage of the bias pack. By using a transformer especially designed for bias-pack service the output voltage may be adjusted to the desired value. When grid current does flow into one of the terminals of the bias pack the current contribution from the pack decreases until at a certain value of grid current the section of the 5Y3-GT rectifier tube in use will be cut off and $R_1, R_2, R_3,$ or R_4 (whichever one is in use) will be acting only as a grid leak on the amplifier stage.

Also illustrated at the bottom of Figure 14 is a circuit whereby a VR tube may be used to supply regulated bias voltage to a stage. However, with this circuit the permissible d-c grid current to the amplifier stage is limited to about 30 ma. since the total grid current passes through the VR tube. Resistor R_5 serves to cause a fixed minimum value of current of from 5 to 8 ma. to pass through the VR tube.

Bias Pack Considerations

It should be borne in mind that when a conventional power supply is used "inverted" in order to provide bias to a stage drawing grid current, the grid current flows in the same direction as the bleeder current. This means that the grid current does not flow through the power pack as when a pack is used to supply plate voltage, but rather through the bleeder. The transformer and

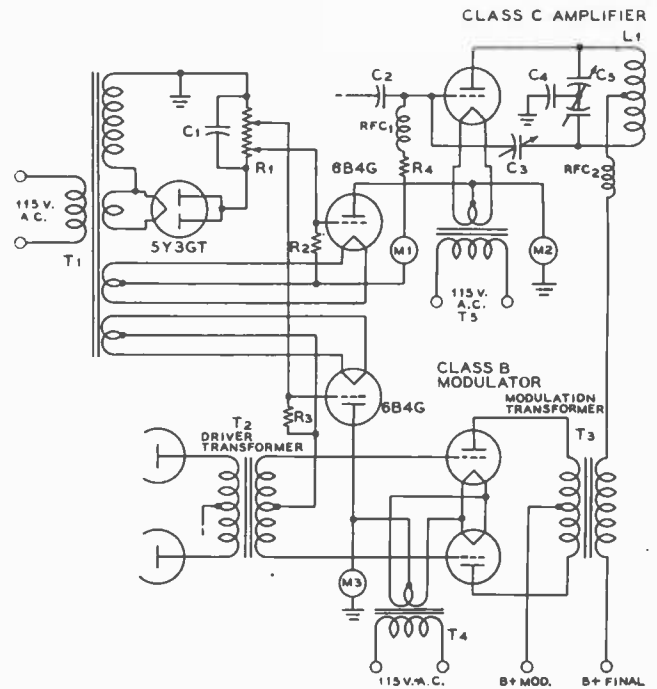

Figure 13.

SPECIAL BIAS PACK FOR USE WITH CATHODE-CIRCUIT METERING.

The R_1 - C_1 circuit may consist of a 2- μ fd. 1000-volt capacitor and a group of 47K 1-watt resistors in series, with a tap switch selecting the junction points between the resistors as a voltage divider. R_1 and R_2 should be 100K 2-watt resistors. All other circuit values are conventional. See text for discussion.

chokes in the bias pack actually have less work to do when the biased stage is drawing grid current, because the greater the grid current flowing through the bleeder the greater the voltage drop across it and the less current the bias pack supplies to the bleeder. In fact, if the grid current is great enough and the bleeder resistor high enough, the voltage developed across the bleeder will be greater than the maximum voltage which the power pack can deliver, and hence the power pack will be delivering no current to the bleeder. Under these conditions, it is quite possible for the voltage to exceed the voltage rating of the bias-pack filter capacitors.

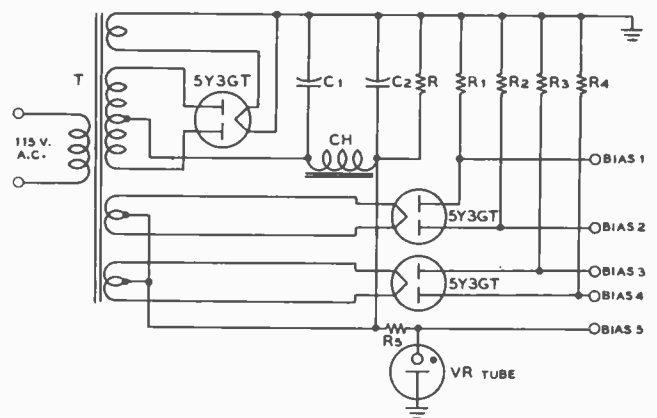

Figure 14.

GRID-BIAS SUPPLY USING DIODE LIMITERS.

This circuit may be used where regulation of the bias voltage is not necessary. Resistors $R_1, R_2, R_3,$ and R_4 should be the proper value of grid leak for the r-f amplifier stage. A VR tube may be used as a regulator for a stage drawing not more than about 30 ma. of grid current in the manner shown at the bottom of this figure.

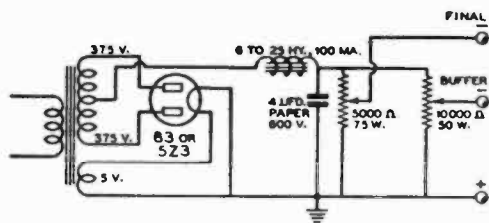

Figure 15.
SIMPLE BIAS POWER SUPPLY.

This power supply will deliver up to 250 volts of protective bias to the various stages of a high-power 'phone or c-w transmitter. A safety factor has been provided in the rating of the filter capacitor so that the pack may be used at full output voltage with a stage running heavy grid current. The power transformer should have a rating of about 75 ma. This type of bias pack does not have good regulation and is subject to interaction between the grid currents of the two stages to which it feeds bias.

Bear in mind that the bleeder always acts as a grid leak when grid current is flowing, and while the effect can be minimized by making the resistance quite low, all grid current must flow through the bleeder, as it cannot flow back through the bias pack.

Class C amplifiers, both c-w and plate modulated, require high grid current and considerably more than cutoff bias, the bias sometimes being as high as 4 or 5 times cutoff. To protect the tubes against excitation failure, it is desirable that fixed bias sufficient to limit the plate current to a safe value be used. This is normally the amount of bias that would be used on the same tubes at the same plate voltage in a Class B modulator. It is best practice to obtain only this amount of bias from a bias pack, the additional required amount being obtained from a variable grid leak which is adjusted for correct bias and grid current while the stage is running under normal conditions.

This condition is such that the voltage divider tap of the bias pack will be delivering only a portion of the full bias pack voltage when the biased stage is inoperative. Then, when grid current flows to the biased stage, there is no danger of the voltage rising to dangerously high values across the filter capacitors in the bias pack.

A bias power supply for providing "protective bias" to the r-f stages of a medium-power radio transmitter is shown in Figure 15.

Two bleeder resistors with slider adjustments provide any desired value of negative grid bias for the r-f amplifiers. The location of the slider on the resistors should be determined experimentally with the amplifier in operation, since the direct grid current of the r-f amplifier itself will affect the voltage across the bias supply taps. The circuit illustrated is practically free from reaction between buffer and final amplifier bias.

Transformerless Power Supplies

Figure 16 shows a group of five different types of transformerless power supplies which are operated directly from the a-c line. Circuits of the general type are normally found in a.c.-d.c. receivers but may be used in low-powered exciters and transmitter bias packs and in test instruments. When circuits such as shown at (A) and (B) are operated directly from the a-c line, the rectifier element simply rectifies the line current and delivers the alternate half cycles of energy to the filter network. With the normal type of rectifier tube, load currents up to approximately 75 ma. may be employed. The d-c voltage output of the filter will be slightly less than the r-m-s line voltage, depending upon the particular type of rectifier tube employed. With the introduction of the miniature selenium rectifier, the transformerless power supply has become a very convenient source of moderate voltage at currents up to ap-

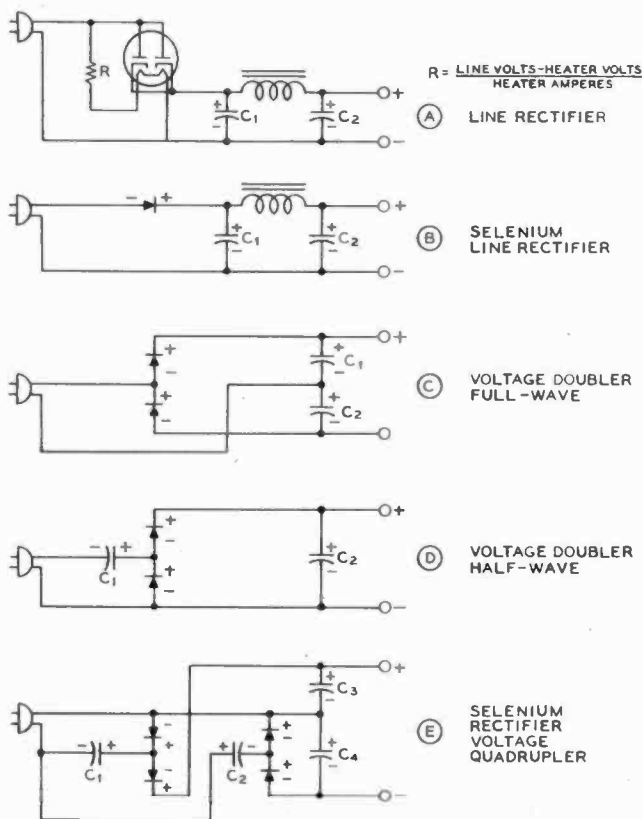

Figure 16.
LINE-RECTIFIER AND VOLTAGE-DOUBLER CIRCUITS.

The application of these circuits is described in the text.

proximately 100 ma. A number of advantages are offered by the selenium rectifier as compared to the vacuum tube rectifier. Outstanding among these are the factors that the selenium rectifier operates instantly, and that it requires no heater power in order to obtain emission. The amount of heat developed by the selenium rectifier is very much less than that produced by an equivalent vacuum-tube type of rectifier.

In the circuits of Figure 16, (A), (B) and (C), capacitors C₁ and C₂ should be rated at approximately 150 volts and for a normal degree of filtering and capacitance, should be between 15 to 60 μfd. In the circuit of Figure 16D, Capacitor C₁ should be rated at 150 volts and capacitor C₂ should be rated at 300 volts. In the circuit of Figure 16E, capacitors C₁ and C₂ should be rated at 150 volts and C₃ and C₄ should be rated at 300 volts.

The d-c output voltage of the line rectifier may be stabilized by means of a VR tube, such as has been described earlier in this chapter. However, due to the unusually low internal resistance of the selenium rectifier, transformerless power supplies using this type of rectifying element can normally be expected to give very good regulation.

Voltage-Doubler Circuits

Figures 16C and 16D illustrate two simple voltage-doubler circuits which will deliver a d-c output voltage equal approximately to twice the r.m.s. value of the power line voltage. The no-load d-c output voltage is equal to 2.82 times the r.m.s. line voltage value. At high current levels, the output voltage will be slightly under twice the line voltage. The circuit of Figure 16C is of advantage when the lowest level of ripple is required from the power supply, since its ripple frequency is equal to twice the line frequency. The circuit of Figure 16D is of advantage when

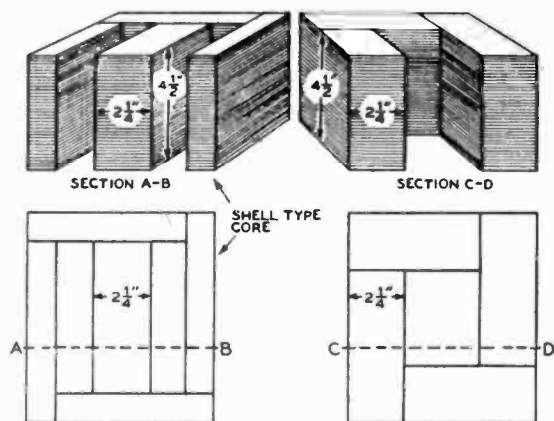

Figure 17.
TYPES OF TRANSFORMER CORES.

it is desired to use the grounded side of the a-c line in a permanent installation as the return circuit for the power supply.

Voltage Quadrupler The circuit of Figure 16E illustrates a voltage quadrupler circuit utilizing four of the miniature selenium rectifiers. In effect this circuit is equivalent to two voltage doublers of the type shown in Figure 16D with their outputs connected in series. The circuit delivers a d-c output voltage under light load approximately equal to four times the r-m-s value of the line voltage. The no-load d-c output voltage delivered by the quadrupler is equal to 5.66 times the r-m-s line voltage value and the output voltage decreases rather rapidly as the load current is increased.

In each of the circuits in Figure 16 where selenium rectifiers have been shown, conventional high-vacuum rectifiers may be substituted with their filaments connected in series and an appropriate value of line resistor added in series with the filament string.

Vibrator Power Packs The vibrator-type power supply has as its heart a step-up transformer operated from a storage battery by means of a vibrating-reed interrupter connected in series with the battery and primary. The job of the interrupter is to chop up the direct current from the battery at a regular rate so as to produce rising and falling magnetic flux in the transformer and consequently a high alternating voltage across the secondary winding. Standard automobile radios employ vibrator-type power supplies.

Vibrator-type power supplies and replacement vibrators may be purchased so reasonably that home building of these units is not feasible. The vibrator pack generally employed in portable amateur transmitters and receivers is driven by a 6-volt storage battery.

One type vibrator power supply utilizes a standard tube, such as type 6X5, to rectify the secondary voltage. In this respect, it does not differ from the well-known power line-operated power supply. Another type, however, employs an extra pair of vibrator contacts to rectify the high-voltage output by mechanical action.

The vibrator transformer-rectifier combination requires the usual capacitor-choke filter to smooth out the rectified current pulsations. In addition, r-f filters must be included in the circuit to minimize transmission of damped wave r-f voltages generated by the sparking contacts of the vibrator.

Vibrator-type power supplies are commercially available with d-c output ratings as high as 400 volts at 200 ma.

Dynamotors The dynamotor is an improved type of motor generator designed specifically to supply d-c plate, screen and grid voltages for portable radio transmitters and receivers. The dynamotor type of construction differs from the conventional motor generator in that both motor and generator coils are wound on the same armature core. Small-sized portable radio dynamotors are designed to run on low d-c voltages, from 6 to 24, delivered by storage batteries. The 6-volt type is in common amateur use.

Dynamotors may be supplied with built-in filters so that the machine need only be connected to the battery and radio equipment. 6-volt dynamotors are available with d-c output ratings as high as 500 volts at 200 ma.

25-4 Transformer Design

A common problem in radio and allied work is to determine how a transformer can be built to supply certain power requirements for a particular application, or how to calculate the windings needed to fit a certain transformer core which is already on hand. These problems can be solved by a small amount of calculation.

The most important factor in determining the size of any transformer is the amount of core material available. The electrical rating, as well as the physical size, is determined almost entirely by the size of the core. The core material is also important. The present practice is to use high-grade silicon-steel sheet. It will be assumed that this type of material is to be employed in all construction herein described, but transformers made from such materials will have about 50 to 60 per cent of the power rating, pound for pound of core, as those made from silicon-steel.

The Core The core size determines the performance of a transformer because the entire energy circulating in the transformer (except small amounts of energy dissipated in resistance losses in the primary) must be transformed from electrical energy in the primary winding to magnetic energy in the core, and reconverted into electrical energy in the secondary. The amount of core material determines quite definitely the power that any transformer will handle.

Transformer cores are often designed so that if the losses per cubic inch of core material are determined, these losses can be used as a basis for calculating the rating of the transformer. These losses exist in watts, and are divided between the eddy current loss and the hysteresis loss. The eddy current loss is the loss due to the lines of force moving across the core, just as if it were a conductor, and setting up currents in it.

Induced currents of this type are very undesirable and they are merely wasted in heating the core, which then tends to heat the windings, increase the resistance of the coils, and reduce the overall power handling ability of the transformer. To reduce such losses, transformer cores are made of thin sheets, usually about no. 29 gauge. These sheets are insulated from each other by a coat of thin varnish, shellac or japan, or by the iron-oxide scale which forms on the sheets during the manufacturing process and which forms a good insulator between sheets.

Hysteresis The magnetic flux in the core lags behind the magnetizing force that produces it, which is, of course, the primary supply. Because all transformers operate on alternating current, the core is subjected to continuous magnetizing and demagnetizing force, due to the alternating effect of the a.c. field. This *hysteresis* (meaning "to lag") heats the iron, due to molecular friction caused by the iron molecules re-orienting themselves as the direction of the magnetizing flux changes.

Transformer Design Chart

SECONDARY WINDINGS (Turns for Voltages Given)

HIGH-VOLTAGE WINDING

WATTS	Section of Core (inches)	Core Area (Square inches)	Primary Turns	Primary Wire Size	Turns per Volt	2.5 volts	5.0 volts	6.3 volts	7.5 volts	10 volts	250 volts	300 volts	350 volts	400 volts	450 volts	500 volts	600 volts	700 volts	800 volts	900 volts	1000 volts	1250 volts	1500 volts	
10	1/2 x 1/2	.25	3500	31	32	80	160	205	240	320														
10	1/2 x 5/8	.31	2800	31	24.2	61	122	147	182	242														
12	1/2 x 3/4	.37	2300	30	20.0	50	100	126	150	200														
12	5/8 x 5/8	.38	2280	30	19.6	48	96	124	147	196														
15	5/8 x 3/4	.46	1875	29	16.1	42	84	105	124	161														
22	5/8 x 1	.62	1400	28	12.2	31	61	77	92	122														
20	3/4 x 3/4	.55	1570	28	13.6	34	68	86	102	136														
25	3/4 x 1	.75	1150	27	10.0	25	50	63	75	100	2620	3150	3700	4200	4750	5250								
30	3/4 x 1 1/4	.93	930	26	8.1	21	42	52	62	81	2100	1500	3140	3400	3800	4200								
50	3/4 x 1 1/2	1.12	770	24	6.7	17	34	43	50	67	1860	2100	2500	2840	3150	3500	4200	5000						
50	1 x 1	1.0	860	24	7.5	19	38	48	57	75	1950	2400	2700	3150	3600	3900	4700	5500						
60	1 x 1 1/4	1.25	690	23	6.0	15	30	38	45	60	1600	1900	2200	2500	2800	3150	3800	4400						
65	1 x 1 1/2	1.50	575	23	5.0	13	25	32	38	50	1300	1575	1850	2100	2400	2650	3150	3700						
75	1 x 1 3/4	1.75	490	22	4.2	11	21	27	31	42	1100	1320	1550	1750	2000	2200	2650	3150	3800	4000	4400			
110	1 x 2	2.0	430	21	3.7	9	18	23	28	37	980	1170	1370	1550	1750	1960	2300	2750	3100	3500	3900			
105	1 1/4 x 1 1/4	1.56	550	21	4.8	12	24	31	36	48	1260	1510	1770	2050	2240	2510	3050	3500	4100	4500	5020			
100	1 1/4 x 1 1/2	1.87	460	21	3.8	9	19	25	29	38	1000	1200	1400	1600	1800	2000	2400	2720	3200	3560	4000			
120	1 1/4 x 1 3/4	2.18	400	20	3.5	9	18	21	26	35	920	1100	1315	1470	1650	1840	2200	2560	2940	3300	3700	4620	5500	
140	1 1/4 x 2	2.5	350	19	3.2	8	16	20	24	32	840	1020	1180	1340	1510	1680	2050	2350	2680	3000	3380	4200	5050	
125	1 1/2 x 1 1/2	2.25	380	20	3.3	8	16	21	25	33	870	1040	1210	1400	1560	1730	2100	2420	2800	3120	3500	4400	5250	
150	1 1/2 x 1 3/4	2.64	330	18	2.9	7	14	19	22	29	760	910	1130	1220	1360	1530	1840	2100	2450	2750	3050	3800	4650	
200	1 1/2 x 2	3.0	290	17	2.42	6	12	15	18	24	630	765	890	1020	1150	1265	1522	1780	2050	2380	2350	3200	3840	
300	2 x 2	4.0	215	15	1.87	5	9	12	14	19	490	590	690	780	880	980	1180	1360	1570	1760	1950	2350	2940	
400	2 x 2 1/2	5.0	175	14	1.52	4	8	10	12	15	395	470	550	640	710	790	950	1110	1265	1420	1590	1980	2400	
500	2 x 3	6.0	145	13	1.26	3	6	8	9	12	330	395	455	530	595	660	790	920	1060	1200	1330	1650	2000	

Saturation The higher the field strength, the greater the heat produced. A condition can be reached where a further increase in magnetizing force does not produce a corresponding increase in the flux density. This is called "saturation," and is a condition which would cause considerable heat in a core. In practice, it has been found that all core material must be operated with the magnetic flux well below the limit of saturation.

Core Losses All core losses manifest themselves as heat, and these losses are the determining factor in transformer rating. They are spoken of as "total core loss," generally used as a single figure, and for common use a core loss of from 0.75 watt to 2.5 watts per pound of core material can be assumed for 60 cycles. The lower figure is for the better grades of thin sheet, while the higher loss is for heavier grades.

About 1 watt per pound is a very satisfactory rating for common grades of material. This rating is also dependent on the manner in which the transformer is built and mounted, and on the ease with which the heat is radiated from the core. Transformers with higher losses may be used for intermittent service.

The transformer core loss can be assumed to be from 5 to 10 per cent of the total rating for small transformers. Thus, if the core loss is known, the rating of the transformer can be easily determined. If the figure of 1 watt per pound is assumed, the problem is further simplified. To determine the rating of the transformer, weigh the core. If, for example, the core weighs 10 pounds, the transformer will handle from 100 to 200 watts. Such a transformer core can be assumed to have about 150 watts nominal rating.

If the weighing of the core is inconvenient, the weight can be calculated from the cubic content or volume. Sheet-steel core laminations weight approximately one-fourth pound per cubic inch.

Transformer cores are generally made in two types: shell, and core. The shell-type has a center leg which accommodates the windings, and this is twice the cross-sectional areas of the side legs. The core-type is made from strips built up into a hollow-like affair of uniform cross section. For the shell-type core, the area is taken as the square section of the center leg, in this case $2\frac{1}{4} \times 4\frac{1}{2}$ inches and in the core-type, this area is taken as the section of one leg, and is also $2\frac{1}{4} \times 4\frac{1}{2}$ inches, or an actual core area in both cases of 10.1 square inches, which is large enough for a comparatively large transformer.

Turns Per Volt To determine the number of turns for a given voltage, apply the following formula:

$$E = \frac{4.44 N B A T}{10^6}$$

Where E equals the volts of the circuit; N, the cycles of the circuit; B, the number of magnetic lines per square inch of the magnetic circuit; A, the number of square inches of the magnetic circuit; and T, the number of turns.

The proper value for B, for small transformers and for ordinary grades of sheet-iron, such as are now being considered, is 75,000 for 25 cycles and 50,000 for 50 or 60 cycles.

Rewriting the above formula

$$T = \frac{E \times 10^6}{4.44 N B A}$$

and since N and B are known

$$T = \frac{10^6}{4.44 \times 60 \times 50,000} \times \frac{E}{A}$$

from which

$$T = 7.5 \times \frac{E}{A}$$

That is, for a transformer to be used on a 60-cycle circuit, the proper number of turns for the primary coil is obtained by multiplying the line voltage by 7.5 and dividing this product by the number of square inches cross section of the magnetic circuit.

On a 25-cycle circuit, the 7.5 becomes 12, and on 50 cycles it becomes 9.

Design Example Assume a transformer core that is to be used on a 115-volt, 60-cycle circuit for supplying power to two rectifier tubes, each of which takes 1,000 volts on the plate. The rectifier is of the full-wave type. The core measures $2\frac{1}{2} \times 4\frac{1}{2}$ inches; hence,

$$T = \frac{7.5 \times 115}{2.25 \times 4.5} = 85 \text{ (to the nearest turn), and the volts per turn equals } \frac{115}{85} = 1.353 \text{ which is the same for all coils.}$$

Now, the secondary coil must have two windings in series, each to give 1,000 volts, and with a middle tap. The secondary turns will be $\frac{2000}{1.353} = 1478$ with a tap taken out at the 739th turn.

Allowing 1,500 circular mils per ampere, the primary wire should be no. 12. The size of the wire on the plate coils may be no. 22 or 24 for a 400 to 300 ma. rating.

To determine the quantity of iron to pile up for a core, it is well to consider 1 to 1.5 volts per turn as a conservative range. For trial, assume 1.25 volts. Then by transforming the first equation

$A = 7.5 \times \frac{E}{T}$ or, the area required is 7.5 times the volts per turn; in this case, $7.5 \times 1.25 = 9.38$ square inches.

The magnetic cross section must be measured at right angles to the laminations that are enclosed by the coil, the center leg when the core is built up around the coil, and either leg where the core is built up inside the coil, that is, between the arrows in the sketches shown in Figure 17.

It should be kept in mind that there is a copper or resistance loss in all transformers. This is caused by the passage of the current through the windings, and is commonly spoken of as the "PR" loss. It manifests itself directly as heat and varies as the load is varied; the heavier the load, the more heat is developed.

This heat, as well as other heat losses, must be removed, or the transformer will burn up. Most transformers are so arranged that both the core and windings can radiate heat into the surrounding air and thus cool themselves. Large transformers are mounted in oil for cooling, and also for the purpose of increasing the insulation factor.

In any transformer, the voltage ratio is directly proportional to the turns ratio. This means that if the transformer is to have 110-volts input and 250 turns for the primary, and if the output is to be 1,100 volts, 2,500 turns will be needed. This may be expressed:

$$\frac{E_p}{E_s} = \frac{T_p}{T_s}$$

It is often more convenient to take the figure obtained for the primary winding and, by dividing by the supply voltage, the number of turns per volt is calculated. This accomplished, the number of turns for any given voltage can be calculated by simple multiplication.

Radio transformers are generally of small size. The matter of power factor can therefore be disregarded, more especially because they work into an almost purely resistive load. In the design of radio transformers, the power factor can be safely assumed as unity, in which case the apparent watts and the actual watts are the same. Admittedly, this is not always a

Copper Wire Table

Gauge No. & S.	Diam. in Mils ¹	Circular Mil Area	Turns per Linear Inch ²			Turns per Square Inch ³			Feet per Lb.		Ohms per 1000 ft. 25° C.	Correct Capacity at 1500 C.M. per Amp. ³	Diam. in min.
			Enamel	S.S.C.	D.S.C. or S.C.C.	D.C.C.	S.C.C.	Enamel	D.C.C.	Bare			
1	289.3	82690	—	—	—	—	—	—	3.947	—	.1264	55.7	7.348
2	257.6	66370	—	—	—	—	—	—	4.977	—	.1593	44.1	6.544
3	229.4	52640	—	—	—	—	—	—	6.276	—	.2009	35.0	5.827
4	204.3	41740	—	—	—	—	—	—	7.914	—	.2533	27.7	5.189
5	181.9	33100	—	—	—	—	—	—	9.980	—	.3195	22.0	4.621
6	162.0	26250	—	—	—	—	—	—	12.58	—	.4028	17.5	4.115
7	144.3	20820	—	—	—	—	—	—	15.87	—	.5080	13.8	3.665
8	128.5	16510	—	—	—	—	—	—	20.01	—	.6405	11.0	3.264
9	114.4	13090	—	—	—	—	—	—	25.23	—	.8077	8.7	2.906
10	101.9	10380	—	—	—	—	—	—	31.82	—	1.018	6.9	2.588
11	90.74	8234	—	—	—	—	—	—	40.12	—	1.284	5.5	2.305
12	80.81	6530	—	—	—	—	—	—	50.59	—	1.619	4.4	2.053
13	71.96	5178	—	—	—	—	—	—	63.80	—	2.042	3.5	1.828
14	64.08	4107	—	—	—	—	—	—	80.44	—	2.575	2.7	1.628
15	57.07	3257	—	—	—	—	—	—	101.4	—	3.247	2.2	1.450
16	50.82	2583	—	—	—	—	—	—	127.9	—	4.094	1.7	1.291
17	45.26	2048	—	—	—	—	—	—	161.3	—	5.163	1.3	1.150
18	40.30	1624	—	—	—	—	—	—	203.4	—	6.510	1.1	1.024
19	35.89	1288	—	—	—	—	—	—	256.5	—	8.210	.86	.9116
20	31.96	1022	—	—	—	—	—	—	323.4	—	10.35	.68	.8118
21	28.46	810.1	—	—	—	—	—	—	407.8	—	13.05	.54	.7230
22	25.33	642.4	—	—	—	—	—	—	514.2	—	16.46	.43	.6438
23	22.57	509.5	—	—	—	—	—	—	648.4	—	20.76	.34	.5733
24	20.10	404.0	—	—	—	—	—	—	817.7	—	26.17	.27	.5106
25	17.90	320.4	—	—	—	—	—	—	1031	—	33.00	.21	.4547
26	15.94	254.1	—	—	—	—	—	—	1300	—	41.62	.17	.4049
27	14.20	201.5	—	—	—	—	—	—	1639	—	52.48	.13	.3606
28	12.64	159.8	—	—	—	—	—	—	2067	—	66.17	.11	.3211
29	11.26	126.7	—	—	—	—	—	—	2607	—	83.44	.084	.2859
30	10.03	100.5	—	—	—	—	—	—	3287	—	105.2	.067	.2546
31	8.928	79.70	—	—	—	—	—	—	4145	—	132.7	.053	.2268
32	7.950	63.21	—	—	—	—	—	—	5227	—	167.3	.042	.2019
33	7.080	50.13	—	—	—	—	—	—	6591	—	211.0	.033	.1798
34	6.305	39.75	—	—	—	—	—	—	8310	—	266.0	.026	.1601
35	5.615	31.22	—	—	—	—	—	—	10480	—	335.0	.021	.1426
36	5.000	25.00	—	—	—	—	—	—	13210	—	423.0	.017	.1270
37	4.453	19.03	—	—	—	—	—	—	16660	—	533.4	.013	.1131
38	3.965	15.72	—	—	—	—	—	—	21010	—	672.6	.010	.1007
39	3.531	12.47	—	—	—	—	—	—	26500	—	848.1	.008	.0897
40	3.145	9.88	—	—	—	—	—	—	33410	—	1069	.006	.0799

¹A mil is 1/1000 (one thousandth) of an inch.

²The figures given are approximate only, since the thickness of the insulation varies with different manufacturers.

³The current-carrying capacity at 1000 C.M. per ampere is equal to the circular-mil area (Column 3) divided by 1000.

Table courtesy P. R. Mallory & Co

correct assumption, but it will suffice for common applications.

The size of the wire to be used in any transformer depends upon the amperage to be carried. For a continuous load, at least 1,000 circular mils per ampere must be allowed. For transformers which have poor ventilation, or continuous heavy load service, or where price is not the first consideration, 1,500 circular mils per ampere is a preferable figure. If, for example, a transformer is rated at 100-watts primary load on 110 volts, the current is

$$I = \frac{W}{V} = \frac{100}{110} = 0.90 \text{ amperes}$$

and if the assumption is 1,000 circular mils per ampere, it will be found that this will require $1,000 \times .90$, or 900 circular mils. The wire table on page 355 shows that no. 20 wire for 1,200 mils is entirely satisfactory. If it is desired to use 1,500 circular mils, instead of 1,000, this will require $1,500 \times .90$ or 1,350 mils, which corresponds to approximately no. 19 wire. The difference seems to be small, yet it is large enough to reduce heating and to improve overall performance. Assume, for tentative design, a 600-volt, 100-ma. high-voltage secondary; a 3-ampere 5-volt secondary; and 2.5-volt 7.5-ampere secondary. Simple calculation will show a 60-watt load on the high-voltage secondary, 15 watts on the 5-volt winding, and 16 watts on the 2.5-volt winding; a total of 91 watts. The core and copper loss is 10 watts. The wire sizes for the secondaries will be for 100-ma. current, no. 30 wire; 3 amperes at 5 volts, no. 15 wire; no. 11 wire for the 7.5-ampere secondary.

For high-voltage secondary windings, a small percentage of turns should be added to overcome the resistance of the small wire used, so that the output voltage will be as high as anticipated. The figures given in the table include this percentage which is added to the theoretical ratio and, consequently, the number of turns shown in the table can be accepted as the actual number to be wound on the core of any given transformer.

Insulation Allowance should always be made for the insulation and size of the windings. Good insulation should be provided between the core and the windings and also between each winding and between turns. Numerous materials are satisfactory for this purpose; varnished paper or cloth, called empire, is satisfactory, although costly. Good bond paper will serve well as an insulating medium for small transformer windings.

Insulation between primary and secondary and to the core must be exceptionally good, as well as the insulation between windings. Thin mica or micanite sheet is very good. Thin

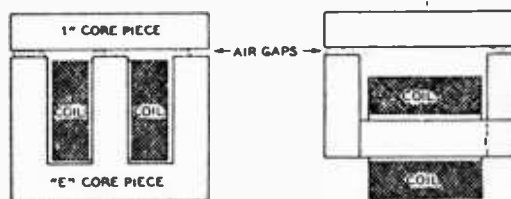

Figure 18.

TYPES OF CHOKE CONSTRUCTION.

The air gap should be approximately 1/32 inch and may be filled with non-magnetic material such as bakelite or fiber.

fibre, commonly called fish paper, is also a good insulator; bristol board, or strong, thin cardboard may also be used. In all cases, the completed coil should be impregnated with insulating varnish, and either dried in air or baked in an oven. Common varnishes or shellac are unsatisfactory on account of the moisture content of these materials. Air-drying insulating varnish is practical for all-around purposes; baking varnish may be substituted, but the fumes given off are inflammable and often explosive. Care must be exercised in the handling of this type of material. Collodion and banana oil lacquer are positively dangerous, and in the event of a short circuit or transformer burn-out, a serious fire may result.

If it is desired to wind a transformer on a given core, it is much better to calculate the actual space required for the windings, then determine whether there is enough available space on the core. If this precaution is not observed, the designer may find that only about half the turns are actually wound on the core, when the space is about three-fourths filled. From 15 to 40 per cent more space than calculated must be allowed. The winding of transformers by hand is a laborious process. Unless the builder is an experienced coil-winder, there is every chance that a sizable portion of the space will be used up by insulation, etc., not sufficient space remaining for the winding. Calculate the cubical space needed for the total number of turns, and allow from 15 to 40 per cent additional space in the core window. This saves much time and labor.

25-5 Filter Choke Considerations

A choke is a coil of high inductance. It offers an extremely high impedance to alternating current, or to current which is substantially alternating, such as pulsating d.c. delivered at the output of a rectifier.

Choke coils are used in power supplies as part of the complete filter system in order to produce an effectively-pure direct

CHOKE TABLE FOR TRANSMITTER POWER SUPPLY UNITS

CURRENT M.A.	WIRE SIZE	NO. TURNS	LBS. WIRE	APPROX. CORE (Area)	AIR GAP	WT. CORE
200	No. 27	2000	1.5	1 1/2" x 1 1/2"	3/32"	4 lbs.
250	No. 26	2000	1.75	1 1/2" x 2"	3/32"	5 lbs.
300	No. 25	2250	2	2" x 2"	1/8"	6 lbs.
400	No. 24	2250	3	2" x 2 1/2"	1/8"	7 lbs.
500	No. 23	2500	4	2 1/2" x 2 1/2"	1/8"	10 lbs.
750	No. 21	3000	6	2 1/2" x 3"	1/8"	14 lbs.
1000	No. 20	3000	7.5	3" x 3"	1/8"	18 lbs.

NOTES: These are approximately based on high-grade silicon steel cores with total air gaps as given. Air gaps indicated are total of all gaps.

The use of standard "E" and "I" laminations is recommended. If strips are used, and if an ordinary square core is used, the number of turns should be increased about 25%. Choke coils built as per the above table will have an approximate inductance of 10 to 15 henrys. Because considerable differences occur due to wind-

ing variations, allowable flux densities of cores, etc., the exact inductance cannot be stated; these chokes will, however, give satisfactory service in radio transmitter power supply systems.

The wire used is based on 1000 circular mils per ampere; this will cause some heating on long runs, and if the chokes are to be used continuously, as in a radiotelephone station in continuous service, it is good practice to use the next size larger choke shown for such loads.



Figure 19.

SHOWING METHOD OF CONSTRUCTION OF A SIMPLE LOW-VOLTAGE RECEIVER OR FREQ-METER POWER SUPPLY.
The circuit diagram of this unit is given in Figure 20.

current from the pulsating current source, that is, from the rectifier. The wire size of the choke must be such that the current flowing through it does not cause an appreciable voltage drop due to the ohmic resistance of the choke; at the same time, sufficient inductance must be maintained to provide ample smoothing of the rectified current.

Smoothing Chokes The function of a smoothing choke is to discriminate as much as possible between the a-c ripple which is present and the desired d.c. that is to be delivered to the output. Its air gap should be large

enough so that the inductance of the choke does not vary materially over the normal range of load current drawn from the power supply, but no larger than necessary to give maximum inductance at full current rating.

Swinging Chokes In certain radio circuits the power drawn by a vacuum tube amplifier can vary widely. Class B audio amplifiers are good examples of this type of amplifier. The plate current drawn by a Class B audio amplifier can vary 5 to 1 or more. It is desirable to keep the d-c output voltage applied to the plate of the amplifier as constant as possible, and the voltage should be independent of the current drawn from the power supply. The output voltage from a given power supply is always higher with a capacitor input filter than with a choke-type input filter. When the input choke is of the *swinging* variety, it means that the inductance of the choke varies widely with the load current drawn from the power supply, due to the fact that high initial inductance is obtained by utilizing a "butt" gap, or none at all as in a transformer core.

A choke is made up from a silicon-steel core which consists of a number of thin sheets of steel, similar to a transformer core, but wound with only a single winding. The size of the core and the number of turns of wire, together with the air gap which must be provided to prevent the core from saturating, are factors which determine the inductance of a choke. The relative sizes of the core and coil determine the amount of d.c. which can flow through the choke without reducing the inductance to an undesirable low value due to magnetization.

The same core material which is used in ordinary radio power transformers, or from those which are burned out, is satisfactory for all general purposes.

In construction, the choke winding must be insulated from the core with a sufficient quantity of insulating material so that the highest peak voltages which are to be experienced in service will not rupture the insulation.

25-6 Power Supply Construction

The construction of power supplies for transmitters, receivers, and accessory equipments is a relatively simple matter electrically since lead lengths are of minor importance and since the circuits themselves are quite simple. There are two factors which do complicate power supply construction, both essentially mechanical problems; these are the problem of mounting the massive and heavy components, and the problem of maintaining adequate voltage insulation in the leads.

An abundance of power supply circuits have been described in the earlier sections of this chapter, and control systems for transmitters and their power supplies have been discussed in Chapter 9. So the construction details on a few power supplies

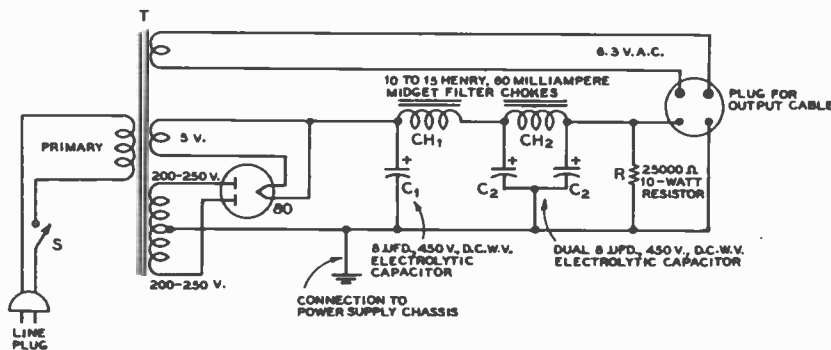

FIGURE 20.

SCHEMATIC OF THE RECEIVER POWER SUPPLY

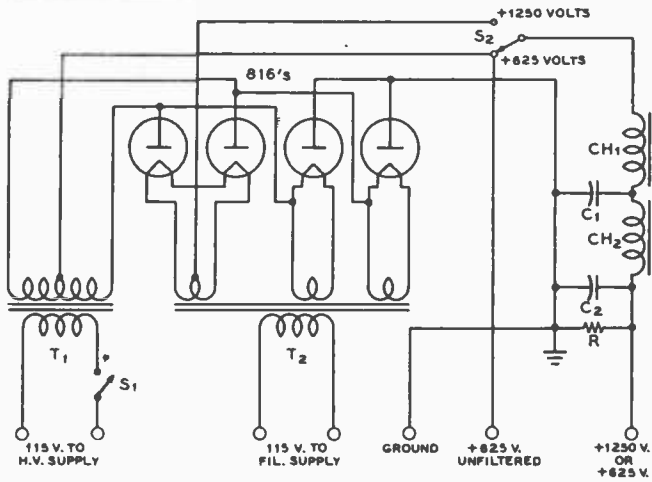

Figure 21.

SCHEMATIC OF THE 1250-VOLT POWER SUPPLY.

- | | |
|---|---|
| C ₁ , C ₂ —2μfd. 1500-volt oil filled | T ₂ —750 v. each side, 250 ma. |
| R ₁ —50,000-ohm 50-watt bleeder | S ₁ —S.p.s.t. toggle switch |
| T ₁ —2.5 volts 2 to 5 a., 2.5 volts 2 to 5 a., 5 v. 3 a. | S ₂ —S.p.d.t. 90° ceramic switch |

of differing degrees of complexity will be shown to illustrate the conventional manner of construction of such units.

Figure 19 shows a simple power supply of the type commonly used to power a receiver or a speech amplifier. The circuit is completely conventional and is given in Figure 20. Many other simple power supplies for light duty are shown in conjunction with the units of equipment described in other chapters of this book.

1250/625 VOLT POWER SUPPLY

Figures 21, 22 and 23 show a convenient method of construction for a medium-power high-voltage supply. The type of construction also indicates the manner in which a neat and useful power supply may be built from a group of components which may have been gathering dust in the "junk box" for many years.

Circuit Four of the small type 816 mercury-vapor rectifiers are used in a bridge circuit from a transformer which delivers 750 volts each side of center tap. A choke-input filter system in conjunction with two 2-μfd. 1500-volt filter capacitors is used. Through the insertion of S₂ in the circuit it is possible to obtain either 625 or 1250 volts from the power supply. S₂ connects the filter system to the cathode of one pair of 816's for full voltage or to the center tap of the plate transformer for half voltage. The current capability of the power supply is twice as great with half-voltage output from the filter system.

Separate leads from the primary of the plate transformer and from the primary of the filament transformer are brought out to the terminal strip on the rear of the chassis. This has been done to facilitate connection of the power supply into a transmitter with no modification of the control system of the existing transmitter, since a common connection between the plate-voltage a-c supply line and the filament-voltage a-c supply line is not included within the power supply unit.

2000/1000 VOLT BRIDGE POWER SUPPLY

The power supply unit shown in the accompanying photographs was designed for operation with the 813 450-watt transmitter which is shown as a complete assembly in Chapter

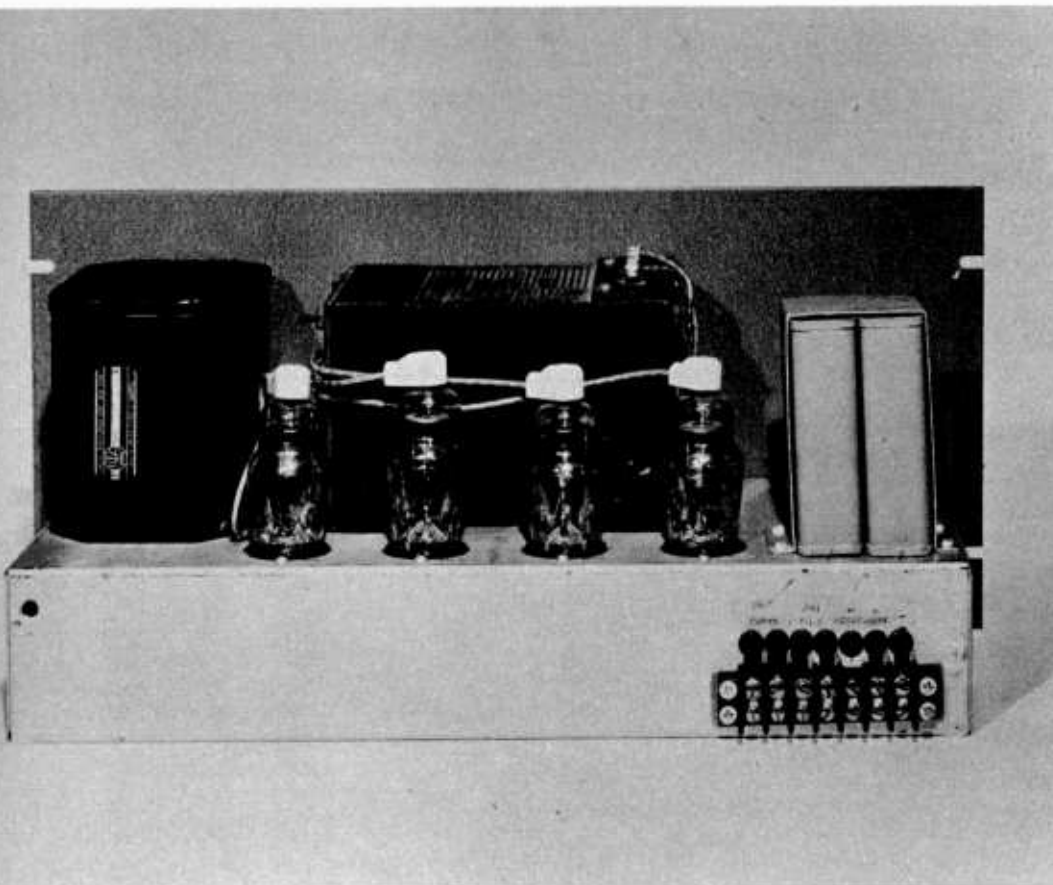

Figure 22.
REAR VIEW OF THE 1250-VOLT POWER SUPPLY.

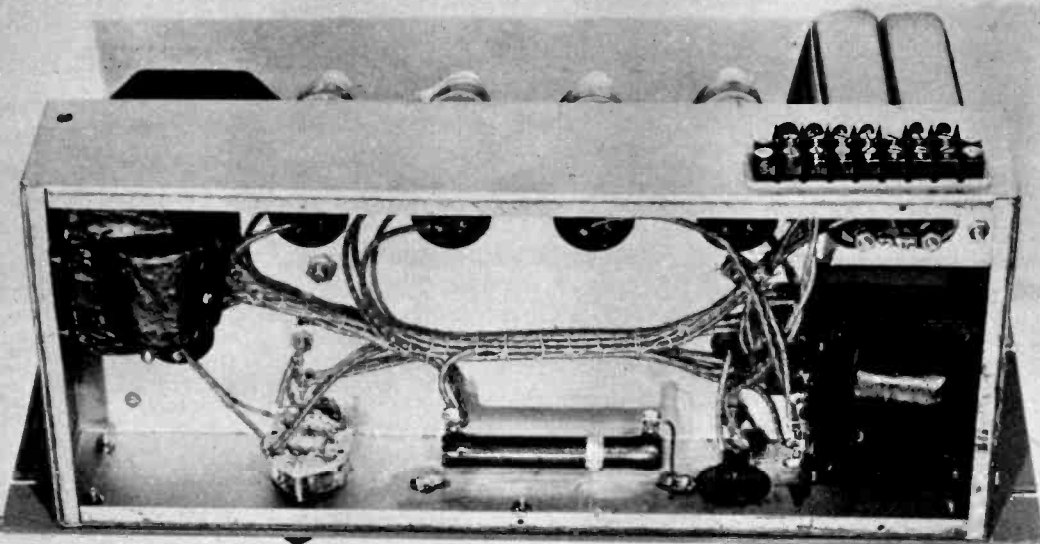

Figure 23.
UNDERCHASSIS VIEW OF THE
1250-VOLT POWER SUPPLY.

26. A bridge rectification circuit is utilized with four 866A/866 tubes operating from a plate transformer designed to supply either 1000 or 1250 volts at 500 ma. By operating the transformer on the 1000-volt tap it is possible to obtain 1000 and 2000 volts simultaneously with a maximum of 200 ma. available at 2000 volts and 200 ma. at 1000 volts. Two bleeder resistors in series are used across the output of the power supply. The bleeder between the 1000-volt and the 2000-volt tap is fixed in value. However, the bleeder between the 1000-volt tap and ground is of the variable type and has a tap taken off to supply 400 volts for the screen of the 813 tube.

The Filter Circuit An unusual filter circuit is used on this power supply to obtain a maximum amount of filtering on both the 1000-volt and 2000-volt taps through the use of only two chokes and two capacitors. The circuit provides the effect of choke input on both supplies and has the additional filtering effect of the two chokes on the 2000-volt supply. The choke in the negative lead must be able to withstand the sum of the plate currents from both the 1000-volt and 2000-volt taps but need be insulated only for moderate voltage since one side of the choke is grounded. A 500-ma. swinging choke has been used in this lead.

Figure 24.
THREE-QUARTER VIEW OF
THE DUAL POWER SUPPLY.

The time-delay relay can be seen in front of the smaller of the two chokes. This relay is physically mounted upon the three-secondary bridge filament transformer for the 866A/866's. The plate-voltage relay RY is mounted on the chassis between the plate transformer and the circuit breaker on the far right. A tap on the forward one of the two bleeders supplies 400 volts for the screen of an 813.

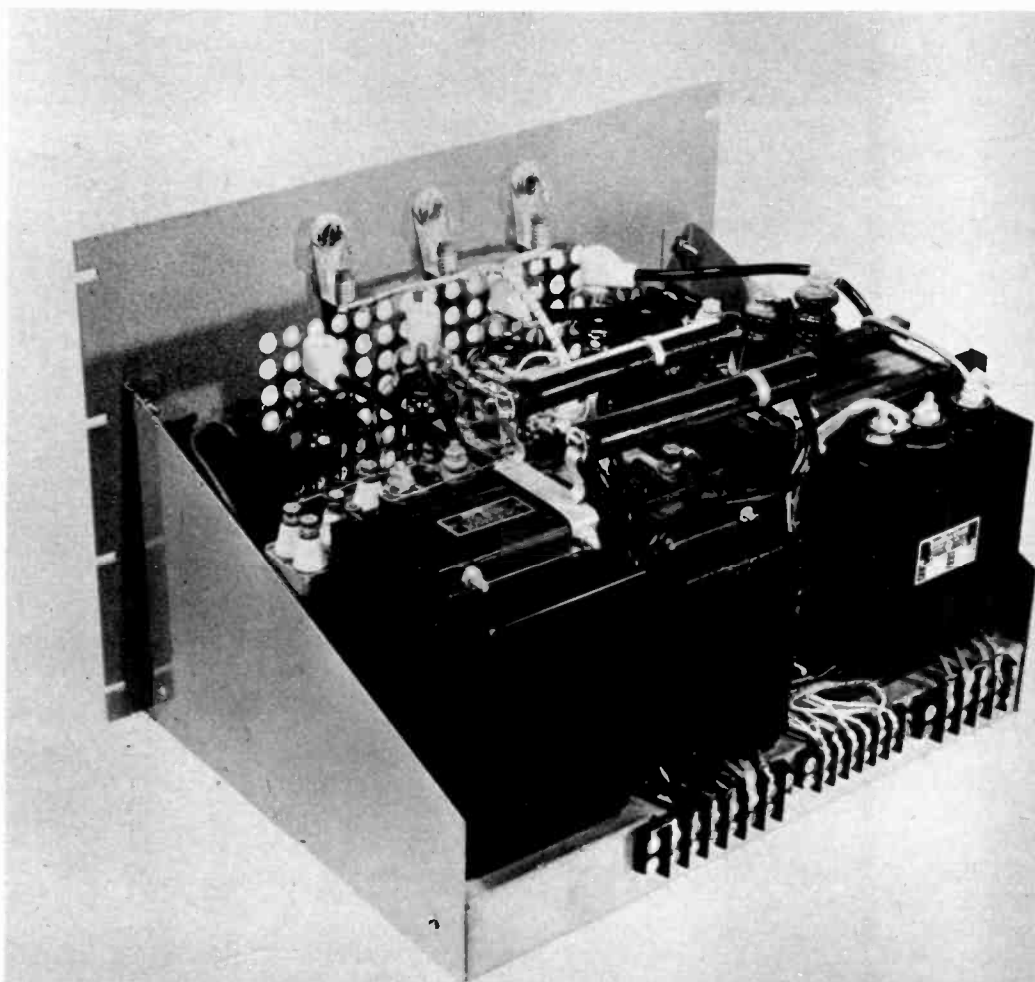

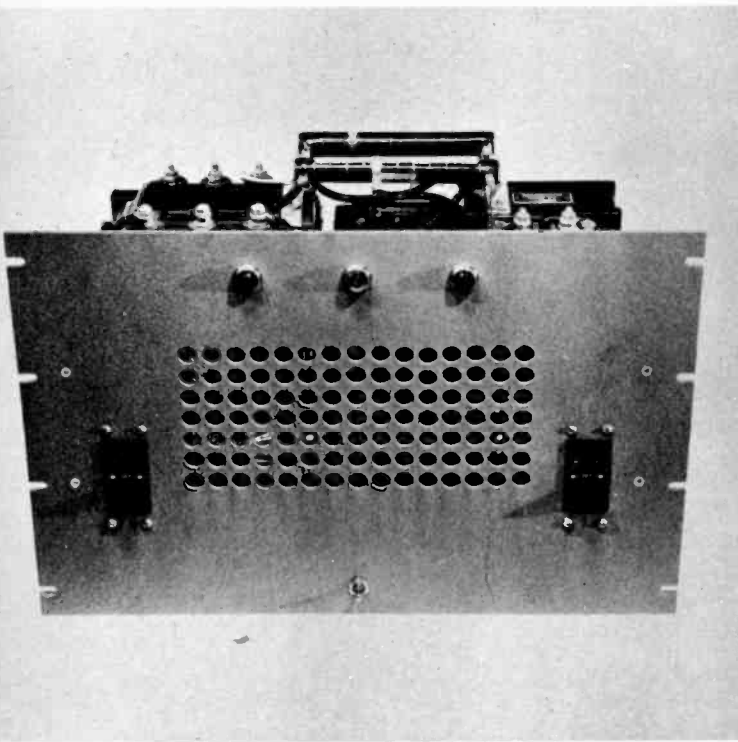

Figure 25.
FRONT VIEW OF THE DUAL POWER SUPPLY.

Control Circuits A simple thermal time-delay relay has been incorporated into the control circuit to insure that adequate time will have elapsed between the lighting of the filaments of the tubes and the application of plate voltage. The time delay unit shown is adjustable in delay from approximately 20 seconds to something over one minute. For normal operation the adjusting screw is set so that 30 seconds delay is obtained. In order to afford either remote or local control of the power supply a 115-volt a-c relay has been incorporated to control the application of the voltage to the primary of the plate transformer. This relay may be operated either by closing the switch from the front panel of the power supply or by closing a switch at the operating position.

Heinemann circuit breakers are used in place of fuses or overload relays for protection of the power supply and associated equipment. These circuit breakers have the additional advantage that they may be used in the normal manner as control switches. When the rated current of the switch is exceeded for a minute or two on a small overload, the switch will snap open. Simply closing the switch restores the circuit and resets the circuit breaker. On a heavy overload the circuit breakers open instantaneously. The main control switch for the entire transmitter is a 15-ampere circuit breaker and the high voltage control switch is a 10-ampere circuit breaker.

All control leads and input and output leads to the power supply are brought to three terminal strips on the rear of the

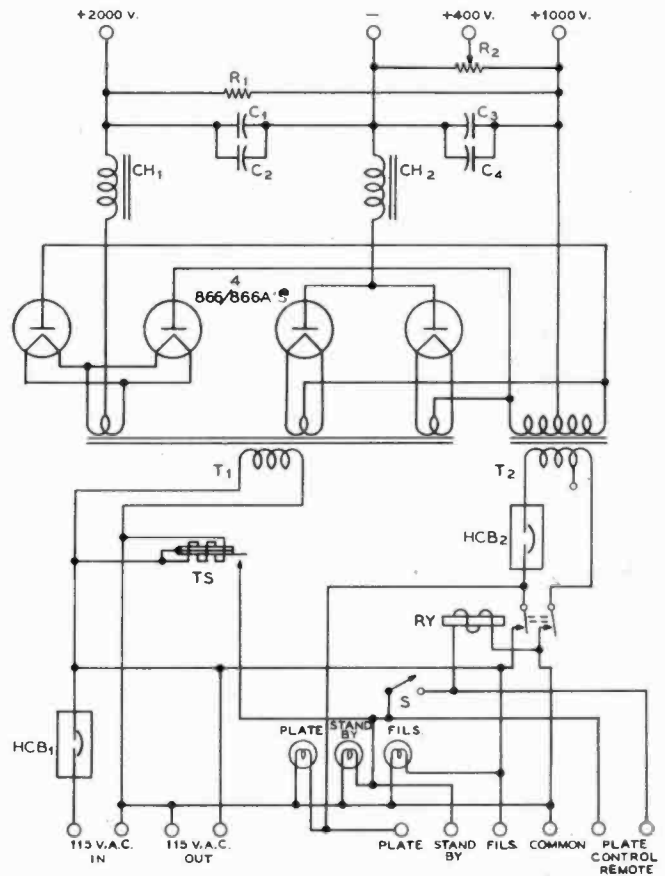

Figure 26.
SCHEMATIC DIAGRAM OF THE 2000-VOLT/1000-VOLT POWER SUPPLY.

- C₁, C₂—2μfd. 2000-volt oil capacitors
- C₃, C₄—2μfd. 1500-volt oil capacitors
- R₁—30,000 ohms 100 watts
- R₂—30,000-ohm 100-watt slider type
- CH₁—5-20 hy. 300-ma. swing choke
- CH₂—5-20 hy. 500-ma. swing choke
- T₁—1560 v. each side, 500 ma.
- T₂—2.5 v. 5 a., 2.5 v. 5 a., 2.5 v. 10 a., 10,000-volt insulation
- TS—Thermal time-delay relay
- RY—10-amp. d.p.s.f. 110-v. relay
- S—5-p.s.f. power control switch
- HCB₁—15-ampere circuit-breaker sw.
- HCB₂—10-ampere circuit-breaker sw.

unit. The terminal strip on the extreme right in Figure 24 has the a-c input and the controlled a-c output of the power supply. The terminal strip in the center acts as termination for control leads and pilot lamp leads. The terminal strip on the left, which is spaced from the chassis by means of a strip of 1/16-inch micarta to afford protection against high voltage breakdown, acts as termination for the high voltage output leads from the power supply.

The pilot light on the left side of the panel comes on as soon as the filaments are lighted; the one in the center is illuminated as soon as the time delay relay has cycled; and the one on the right comes on only when the plate control relay has been closed.

Transmitter Construction

THE equipments shown in this chapter are complete transmitters which either have been assembled from units described elsewhere in this book or have been constructed as complete assemblies. The complete transmitters are shown for the benefit of those who prefer to construct the transmitter as a whole from a tried and proven circuit which has been engineered as an integral unit rather than to work out an individual design from the exciter, amplifier, power supply, and modulator units shown elsewhere in this book.

Although most of the transmitters shown have provisions for radiotelephony, it is a relatively simple matter to omit these provisions if c-w operation exclusively is desired.

DELUXE 1-KW PHONE-C.W. TRANSMITTER

Figures 1 through 6 illustrate a very compact and smoothly operating one-kilowatt phone and c-w transmitter for the bands from 3.5 through 29.7 Mc. While the exciter has been included in this unit, an additional unit under construction is designed for use with an external operating-desk type of exciter-control unit. Also, provision is being made for inclusion of the 50-Mc. band in future units. The transmitter operates from a standard split 230-volt line with grounded neutral.

Figure 1.
FRONT VIEW OF THE DELUXE ONE-KILOWATT TRANSMITTER.

In this photograph the transmitter is installed as it is normally operated. The changeover switches for selecting various antennas can be seen on the wall to the left of the transmitter. The variable-ratio line transformer for controlling the plate voltage to the final stage and modulators, and thus controlling the power input, is mounted below the operating desk.



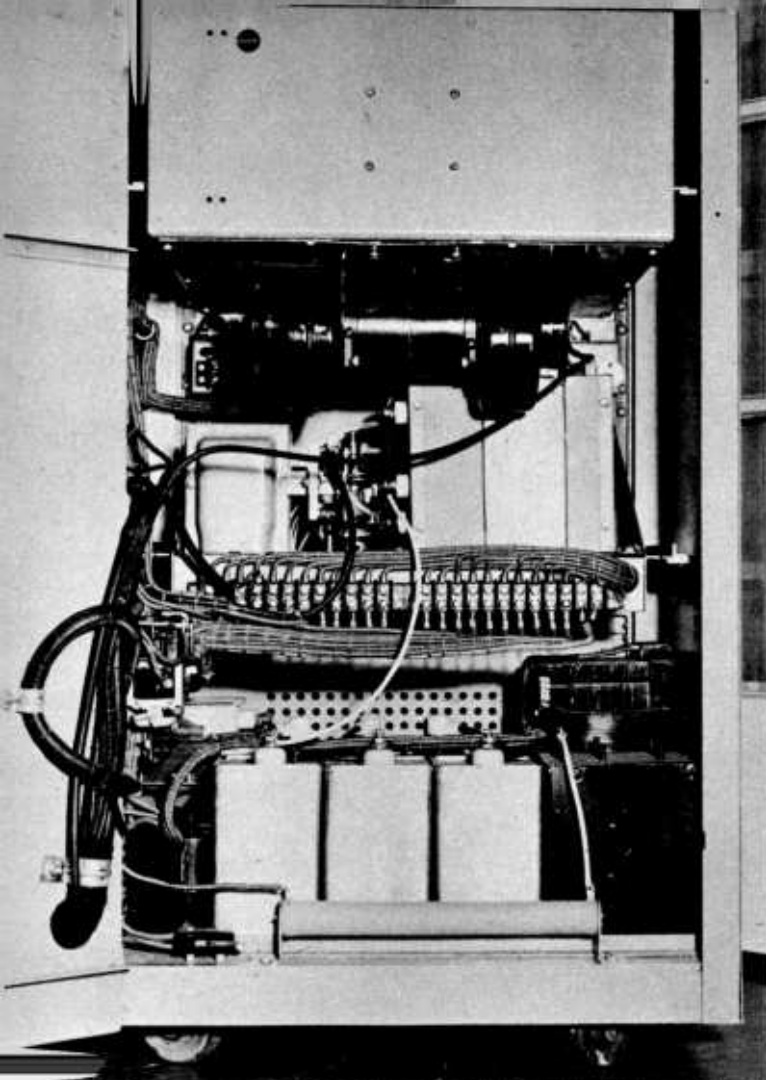

Figure 2.

REAR VIEW OF THE KILOWATT TRANSMITTER.

The doors have been opened to show the internal construction and the wiring of the transmitter in this photograph.

Layout of the Equipment The two high-voltage power supplies and the power-control relays K₁, K₂, and TD₁ are built into the lower portion of the housing for the transmitter. The first deck above houses the 4-125A modulators and their associated input and output transformers, the grid-bias supply, and the control circuits and indicator lights.

The next deck holds the exciter unit (Figure 5), and the final amplifier is mounted on the uppermost deck. Indicating instruments for the equipment are mounted directly in the housing. Protective interlocks are mounted both on the top

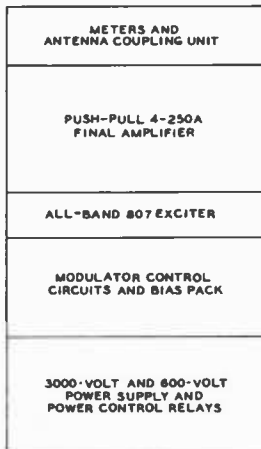

Figure 3. **BLOCK DIAGRAM OF THE TRANSMITTER ASSEMBLY.**

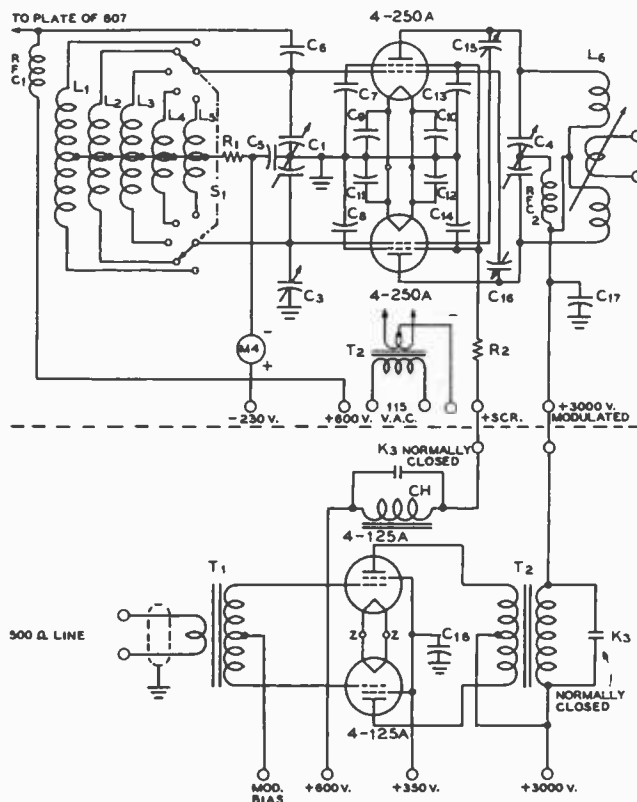

Figure 4. **SCHEMATIC OF THE FINAL AMPLIFIER AND MODULATOR.**

- C₁, C₂—100- μ fd. per section, split-stator capacitor
- C₃—25- μ fd. balancing capacitor
- C₄—50- μ fd. per section split-stator butterfly, 0.5" airgap
- C₅, C₆—0.002- μ fd. 1250-volt mica
- C₇, C₈, C₉, C₁₀, C₁₁, C₁₂, C₁₃, C₁₄—0.005- μ fd. 1250-volt mica capacitors
- C₁₅, C₁₆—Neut. capacitors, see text
- C₁₇—0.002- μ fd. 6000-volt working mica
- C₁₈—10- μ fd. 450-volt elect.
- R₁—1000 ohms 10 watts
- R₂—3000 ohms 100 watts
- RFC₁—2.5-mh. 125-ma. choke
- RFC₂—800-ma. all-band choke
- L₁, L₂, L₃, L₄, L₅, L₆—All band turret
- L₇—Plug-in 1-kw. variable-link coils
- T₁—Line-to-Class B grids trans.
- T₂—One-kw. modulation trans.
- T₃—5-volt 30-ampere fil. trans.

door, which is used for changing the final-amplifier tank coil, and on the rear door. Provision has been made for the use of an external 2-kw. Variac or Powerstat for controlling the plate voltage on the final amplifier and on the modulators.

The Circuit A 6AG7 tube is used in the first stage of the exciter as hot-cathode Colpitts oscillator/multiplier. Five crystal positions are provided and on the sixth position of S₁ the grid of the 6AG7 is grounded and the signal from an external v.f.o. is fed into the cathode. The plate circuit of the 6AG7 uses a "Bandhopper" switched coil. The 6AG7 is used to excite the 807 as an amplifier on all bands through 21.5 Mc. For operation on the 27-30 Mc. range an additional doubler stage using a 6F6 is switched into the circuit by means of S₂. The plate of the 807 is shunt fed by means of an r-f choke in the final-amplifier chassis and the r-f energy is coupled to one side of the split-stator tuned circuit in the grids of the 4-250A final amplifier tubes. A balancing capacitor is connected to the opposite side of the tank circuit to compensate for the output capacitance of the 807. One adjustment of this capacitor serves to give equal excitation to the grids of the two 4-250A's on all bands.

Small neutralizing capacitors in a cross-connected circuit are used to insure complete stability of the 4-250A stage. The

- C₁—100- μ fd. midget variable
- C₂—25- μ fd. air-padder type with shaft
- C₃—25- μ fd. midget mica
- C₄—150- μ fd. midget mica
- C₅, C₆, C₇—0.003- μ fd. mica
- C₈—50- μ fd. midget mica
- C₉—10- μ fd. silver mica
- C₁₀, C₁₁, C₁₂, C₁₃—0.003- μ fd. mica
- C₁₄—0.25- μ fd. 600-volt tubular
- C₁₅—0.005- μ fd. mica
- R₁—50,000 ohms 1 watt
- R₂—500 ohms 2 watts
- R₃—40,000 ohms 20 watts
- R₄—1000 ohms 1 watt
- R₅—50,000 ohms 1 watt
- R₆—25,000 ohms 2 watts
- R₇—3000 ohms 10 watts
- R₈—30,000 ohms 2 watts
- R₉—200 ohms 10 watts
- R₁₀—40 ohms 10 watts
- R₁₁—1000 ohms 1 watt
- R₁₂—10,000 ohms 20 watts
- R₁₃—47,000 ohms 2 watts
- R₁₄—10,000 ohms 1 watt
- R₁₅—1000 ohms 1 watt
- R₁₆—50,000 ohms 20 watts

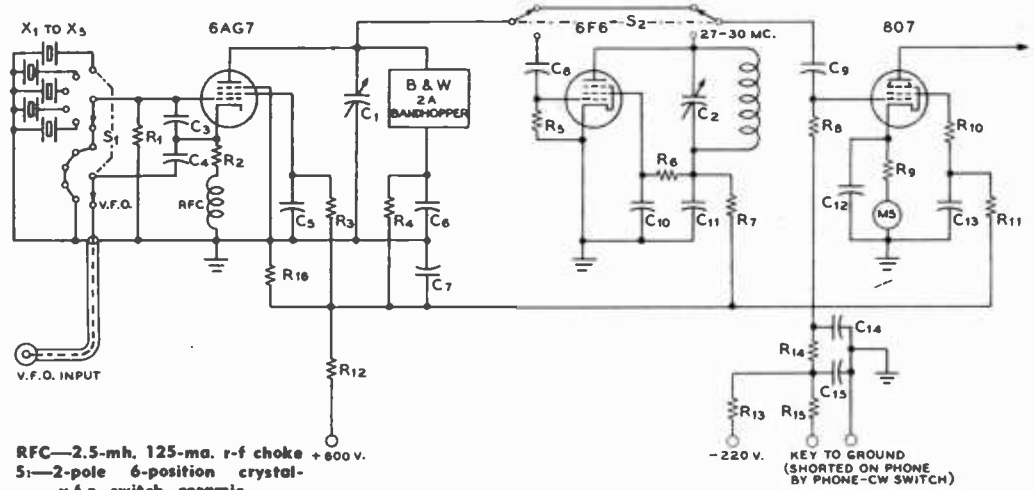

- RFC—2.5-mh. 125-ma. r-f choke + 600 v.
- S₁—2-pole 6-position crystal v.f.o. switch, ceramic
- S₂—D.p.d.t. ceramic switch
- M₅—0-100 d.c. milliammeter

Figure 5. SCHEMATIC DIAGRAM OF THE EXCITER UNIT.

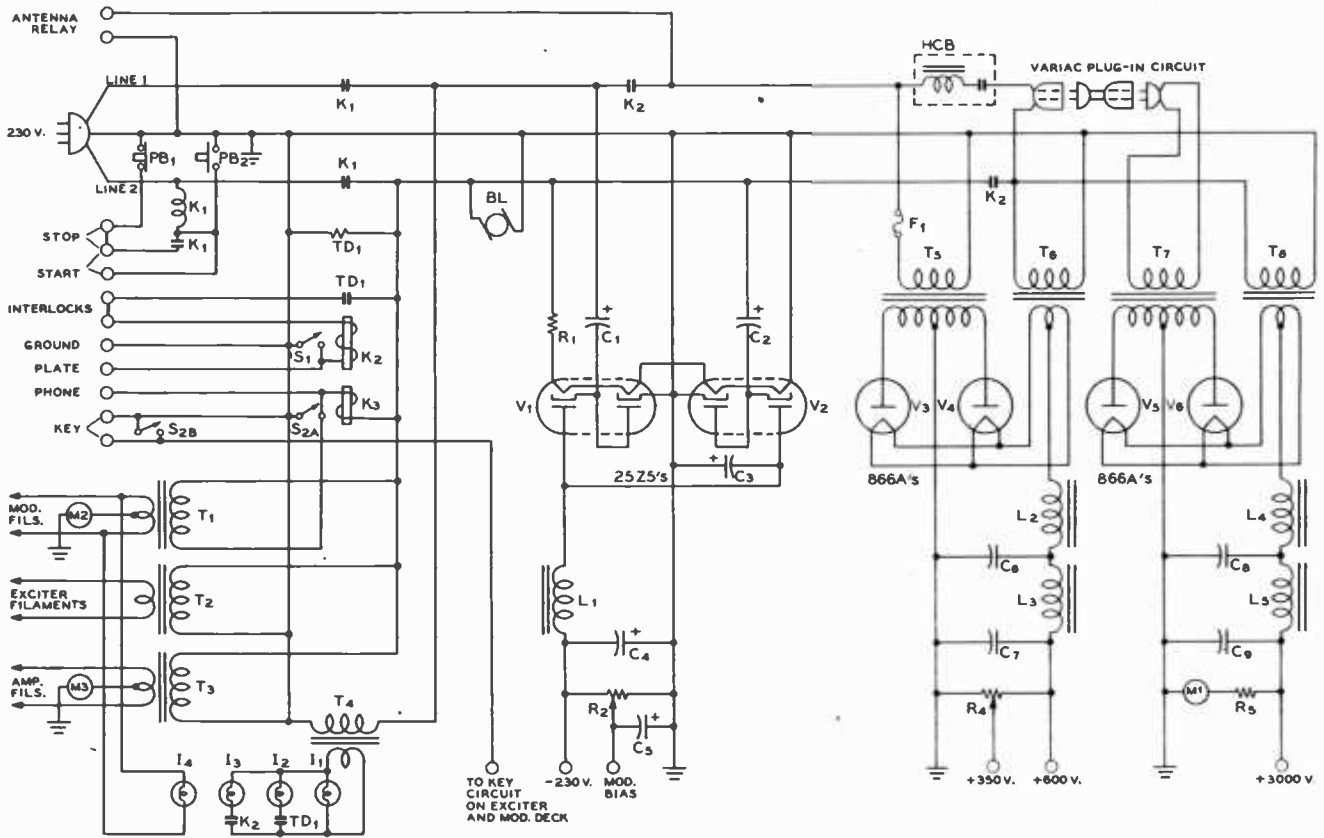

Figure 6. POWER SUPPLY AND CONTROL CIRCUITS FOR THE TRANSMITTER.

- C₁, C₂—40- μ fd. 150-volt elect.
- C₃, C₄—20- μ fd. 450-volt elect.
- C₅—40- μ fd. 150-volt elect.
- C₆, C₇—5- μ fd. 600-volt oil
- C₈, C₉—3- μ fd. 4000-volt oil
- R₁—250-ohms 50-watt slider type tapped at 225 ohms
- R₂—1000 ohms 100-watt slider type resistor tapped at approx. 100 volts
- R₃—20,000 ohms 100-watt slider type tapped at approx. 350 v.
- R₄—100,000 ohms 200 watts
- T₁—5-volt 13-ampere fil. trans.
- T₂—6.3-volt 2.5-ampere trans.
- T₃—Same transformer shown on drawing of amplifier
- T₄—6.3-volt 2.5-ampere trans.
- T₅—1540 c.t. 300-ma. trans.
- T₆—2.5-volt 10-ampere trans.
- T₇—6600-v. c.t. 500-ma. trans.
- T₈—2.5-volt 10-amp. h-v ins.
- L₁, L₂—4-hy. 250-ma. chokes
- L₃—300-ma. swinging choke
- L₄—500-ma. h-v swing choke
- L₅—500-ma. filter choke
- M₁—0-50 d-c milliamperes
- M₂—0-500 d-c milliamperes
- M₃—0-750 d-c milliamperes
- K₁—115-volt 3-pole relay
- K₂—115-volt 3-pole relay
- K₃—115-volt antenna-change-over type relay used for phone-c.w.
- TD₁—115-volt time-delay relay
- BL—115-volt blower
- F₁—5-ampere fuse
- HCB—20-ampere circuit breaker
- PB₁—STOP push button, local control
- PB₂—START push button, local control
- S₁—Transmit-receive switch for local control
- S₂—Phone-c.w. switch
- I₁, I₂, I₃, I₄—6.3-volt indicator lights
- V₁, V₂—25Z6 or 25Z5 tubes
- V₃, V₄, V₅, V₆—866A/866 tubes

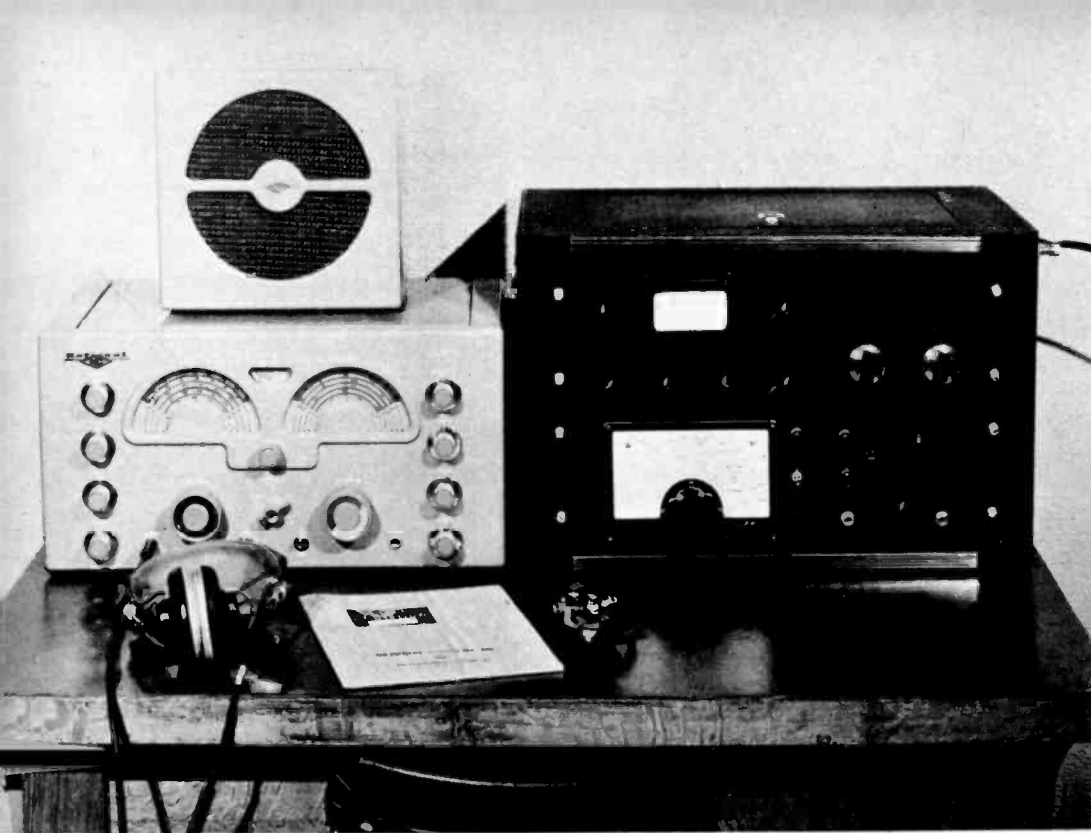

Figure 7.
FRONT VIEW OF THE
PARALLEL-807 150-WATT
TRANSMITTER.

neutralizing capacitors are made by mounting locking-type shaft bushings in the center of a mycalex plate. Short pieces of 1/4-inch shaft are held by the shaft bushings and adjusted until there is no reaction by the plate circuit on the grid current.

Modulation Circuit Combined plate and screen modulation of the beam-tetrode final amplifier is used. The screen current is fed to the tube through a choke and a series resistor from the 600-volt supply. The series choke serves to allow the screen voltage to modulate itself as the plate voltage varies, and the protective resistor is of such a value that the screen dissipation cannot be exceeded regardless of the screen current. The operating value of screen voltage is the rated value of 500 volts. The chassis for the final-amplifier stage is constructed so that the air from a blower mounted below is forced through the bases of the tubes and on the sides of the tube envelopes.

The modulator stage is conventional and uses a pair of 4-125A beam tetrodes as a Class AB₂ amplifier. Audio excitation is provided by a transformer from a 500-ohm line. Approximately 3 watts of audio power from the speech amplifier is required for full modulation of the transmitter. The modulator tubes operate into a plate-to-plate load impedance of 27,000 ohms. The operating plate potential is 3000 volts, screen-voltage is 400 volts, and grid bias is adjusted until the zero-signal plate current is about 60 ma.; approximately 75 volts of bias is required.

Control Circuits Push-button control is used to start and stop the transmitter. Provision has been made for alternate control push buttons at the transmitter and at a remote position. With the arrangement shown either the local or remote buttons may be used to start or stop the transmitter. Protective interlocks on access doors to the interior of the cabinet open the holding circuit on K₂, so that the plate voltage cannot be applied when either door is opened. This system means that the transmitter is completely safe for making minor adjustments in the r-f units when either door is opened.

A pair of 25Z5's (25Z6's can be used) is used as a full-wave voltage doubler from each side of the line to supply 230 volts

of bias to the transmitter. Grid block keying of the 807 stage is used on the transmitter. In the c-w position of the PHONE-C.W. switch the secondary of the modulation transformer and the series screen choke are shorted by K₃. A 0-50 d-c milliammeter in series with the 100,000-ohm bleeder resistor R₄ serves as a plate voltmeter for the transmitter. The reading of the milliammeter is multiplied by 100 to give the value of plate voltage. With normal grid current of 40 ma. on the final amplifier and normal plate current of 330 ma. at 3000 volts the screen current is 80 ma. Since M₁ is in the cathode of the final amplifier it is necessary to subtract the grid current and screen current from the meter reading to determine the actual plate current and plate input. If desired an additional 0-200 d-c milliammeter may be connected in series with the screen lead of the final amplifier to determine the exact screen current.

Construction Due to the low excitation requirements of the beam-tetrode tube in the final amplifier stage, the entire transmitter can be built very compactly. The final-amplifier chassis, exciter unit, and modulator unit are each constructed as removable assemblies. The two main power supplies, however, are bolted down to the base plate of the housing. The housing itself was constructed of sheet aluminum and aluminum extrusions, but since the entire housing has standard dimensions for 19-inch relay-rack panels a standard cabinet may be used to house the various chassis.

Standard one-kilowatt tank coils are used in the plate circuit of the final amplifier, and a variable-link drive system has been brought out to the front panel. Through the use of this variable antenna-coupling control it is possible to tune the transmitter completely from the front panel.

SELF-CONTAINED 150-WATT C-W TRANSMITTER

The unit shown in Figures 7 through 13 was designed for the apartment dweller who must have a completely self-contained transmitter of minimum size but with moderate power capabilities. It is only necessary to plug in the key and power cord and to attach the antenna to obtain operation on the 3.5, 7.0, 14 and 21 Mc. or 11 and 10-meter c-w bands.

Figure 8.

REAR OF THE 807 TRANSMITTER.

In this photograph the panel of the transmitter has been removed from the cabinet. All the components except the power supplies are mounted from the front panel. The power supplies are mounted from the side and on the bottom of the housing.

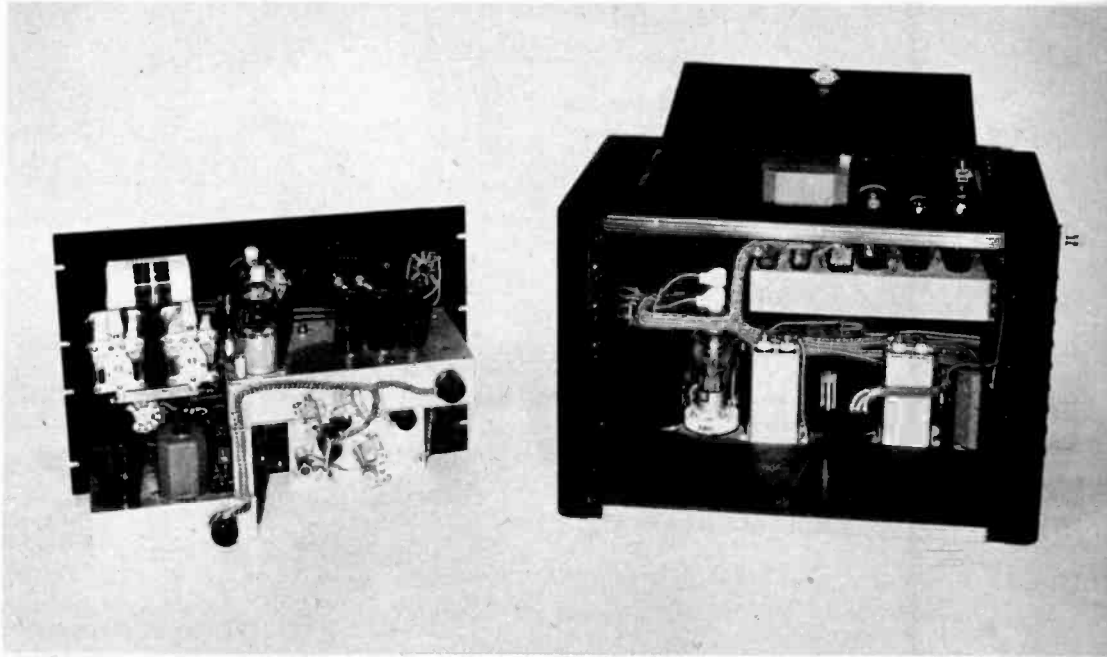

The transmitter uses v-f-o frequency control exclusively, with a built-in 100-kc. crystal calibrator, and has provision for grid modulation of the paralleled 807's in the final amplifier for low-power AM phone work. The power output is approximately 30 watts on phone.

The Circuit A 6SK7-6AG7 v-f-o unit substantially identical to that described in Chapter 21 is built into the unit as frequency control. The v.f.o. has three frequency ranges: 3.5 to 3.8 Mc. for 80, 40, 20, and 10; 3.8 to 4.0 Mc. for the balance of the 80-meter band and 75-meter phone; and a range which includes 3400 to 3450 for the 27.16 to 27.43 Mc. band. For a detailed discussion of the v-f-o unit see the description of the similar unit in Chapter 21. The only special part of this v.f.o. is the range switch S_5 which has been con-

structed on the frame of an APC capacitor, after removal of all plates, by soldering a contact to each of the stator posts and soldering a contact to the rotor stud. The contacts used were obtained from a defunct bakelite bandswitch. The flat contact was soldered to the rotor and a spring contact was soldered to each stator post. The output of the v-f-o unit is coupled to the grid of the first 6V6-GT amplifier/multiplier by means of a length of RG-58/U cable. A midget RCA ceramic-insulated phono plug and jack is used as the coaxial connector between the end of the coaxial cable and the bottom cover of the r-f unit chassis.

The exciter portion of the transmitter consists of three cascaded 6V6-GT stages. The first stage operates either as an amplifier or as a doubler and its plate circuit tunes both the 3.5 and 7.0 Mc. bands through the use of a 200 μfd . variable

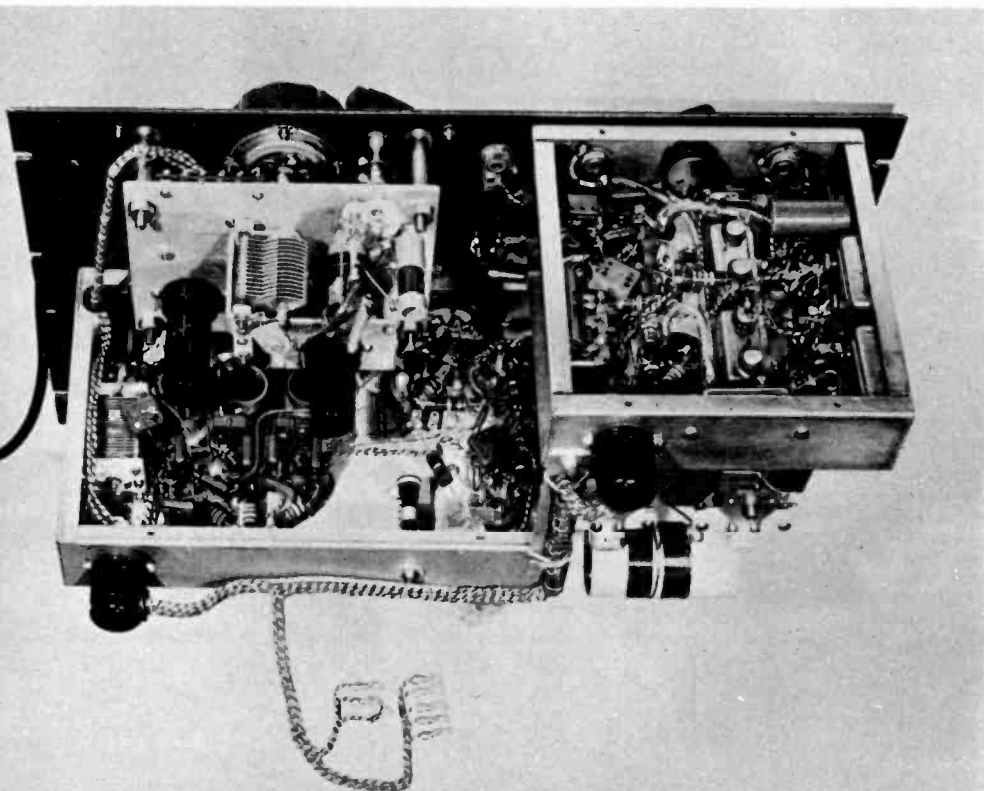

Figure 9.

BOTTOM VIEW OF THE R-F PORTION.

The bottom-cover shields have been removed from the crystal-calibrator and the exciter portion of the transmitter so that the interior construction may be seen.

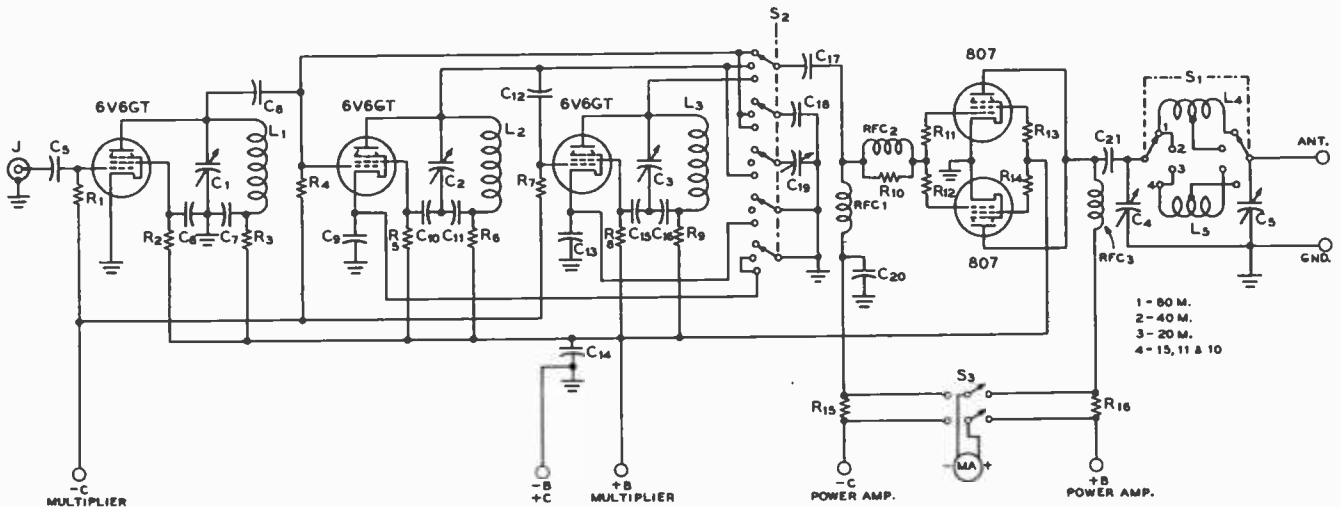

Figure 10.

SCHEMATIC DIAGRAM OF THE R-F CHASSIS OF THE TRANSMITTER.

- C₁—250- μ fd. variable
- C₂—140- μ fd. variable
- C₃—100- μ fd. variable
- C₄, C₇—250- μ fd. 1500-volt variable capacitor
- C₅, C₆—0.003- μ fd. midget mica
- C₈—50- μ fd. midget mica
- C₉, C₁₀, C₁₁—0.003- μ fd. mica
- C₁₂—50- μ fd. midget mica
- C₁₃, C₁₄, C₁₅, C₁₆—0.003- μ fd. mica
- C₁₇—50- μ fd. midget mica
- C₁₈—15- μ fd. ceramic or mica

- C₁₉—25- μ fd. air padder
- C₂₀—0.003- μ fd. midget mica
- C₂₁—0.002- μ fd. 1250-volt working voltage mica
- R₁—100,000 ohms 1/2 watt
- R₂—39,000 ohms 2 watts
- R₃—100 ohms 2 watts
- R₄—100,000 ohms 2 watts
- R₅—39,000 ohms 2 watts
- R₆—100 ohms 2 watts
- R₇—100,000 ohms 2 watts
- R₈—39,000 ohms 2 watts
- R₉—100 ohms 2 watts
- R₁₀—47 ohms 2 watts

- R₁₁, R₁₂—22 ohms 2 watts
- R₁₃, R₁₄—47 ohms 2 watts
- R₁₅—10 ohms 2 watts
- R₁₆—300-m Ω . shunt removed from meter
- RFC₁—2.5-mh. 125-ma. choke
- RFC₂—6 turns no. 20 enam. wound around a 47-ohm 2-watt res.
- RFC₃—1-mh. 300-ma. r-f choke
- L₁—16 turns no. 20 enam. close wound on 1-inch dia. form
- L₂—8 turns no. 18 enam. spaced to 1/2" on 1" dia. form

- L₃—3 turns no. 18 enam. spaced to 1/2" on 1" dia. form
- L₄—23 turns no. 16 enam. on 1 3/4" form tapped at 11 turns
- L₅—10 turns no. 14 bare or plated on 1 3/4" form tapped at 5 t.
- S₁—2-pole 4-position 90° ceramic switch
- S₂—5-pole 3-position ceramic
- S₃—2-pole 3-position wafer sw. with center position unused

tuning capacitor. Only this 6V6-GT is in operation when S₂ is in the position to deliver excitation from this stage to the grids of the 807's. The next 6V6-GT operates as a doubler to the 14-Mc. band or as a tripler to the 21-Mc. band. The third 6V6-GT operates only as a doubler to the 11-meter or 10-meter band.

The excitation bandswitch S₂ has five active circuits. The first circuit connects the grids of the 807's to the first, second, or third exciter tank circuit through coupling capacitor C₁₇. The second circuit connects a 15 μ fd. capacitor C₁₈ across the first exciter tank circuit, whenever the grids of the 807's are not

connected, to compensate for their capacitance to ground. The third circuit connects compensating capacitor C₁₉ across the second multiplier tank circuit when the 807 grids are coupled to the last exciter tank circuit. Through the use of these two compensating capacitors the tuning of L₁ and L₂ is not changed when the grids of the 807's are switched to successive stages. The last two sections of S₂ merely serve to ground the cathodes of the successive 6V6-GT stages as their use is required for exciting the 807's.

Resistors R₁₁, R₁₂, R₁₃, R₁₄, and R₁₅ are parasitic suppressors connected in series with the grids and screens of the 807's. RFC₃ consists of 6 turns of no. 18 bare wire wound around the 47-ohm 2-watt resistor R₁₆.

A pi network is used as an output coupling and antenna matching system from the plates of the 807's. A four-position tap switch S₁ selects the proper amount of inductance for use of the matching network on the various frequency bands. A single-wire antenna operating against ground may be used with the transmitter or a balanced line may be used with one side of the line connected to the antenna post and the other side connected to the ground post.

A 0-300 d-c milliammeter in conjunction with S₂ is used to measure the plate current and grid current to the 807's. The shunt is removed from inside the instrument and placed across the switch contacts as R₁₆. The shunt is wound around a 100K 1/2-watt resistor as a support. With a 10-ohm resistor as R₁₅ the full-scale reading of the instrument on the grid-current position is approximately 15 ma.

The frequency-calibrating and audio-amplifier unit is mounted on the lower right portion of the panel below the antenna-tuning network. A portion of the output of the 6AG7 v-f-o output stage is coupled by means of a short coaxial line to the grid of the 6K8 tube. The 100-kc. standard crystal is used as a coupling impedance to the grid of the triode portion

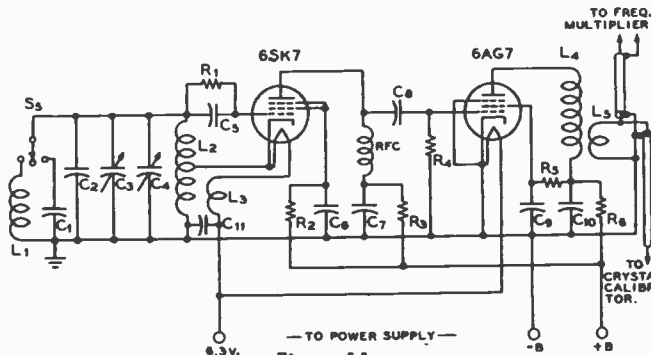

Figure 11.

SCHEMATIC DIAGRAM OF THE V-F-O UNIT.

This v-f-o is identical to the "Operating-Table V-F-O Unit" described in Chapter 21 except that the lowest frequency band is not included since 6-meter operation is not required. Hence the tuned circuit values are slightly different as follows:

- C₁—100- μ fd. ceramic zero coeff.
- C₂—Two 350- μ fd. zero coeff. ceramic in parallel with one 75- μ fd. negative coeff. ceramic
- C₃—35- μ fd. negative coeff. ceramic trimmer
- C₄—75- μ fd. midget variable efficient ceramic

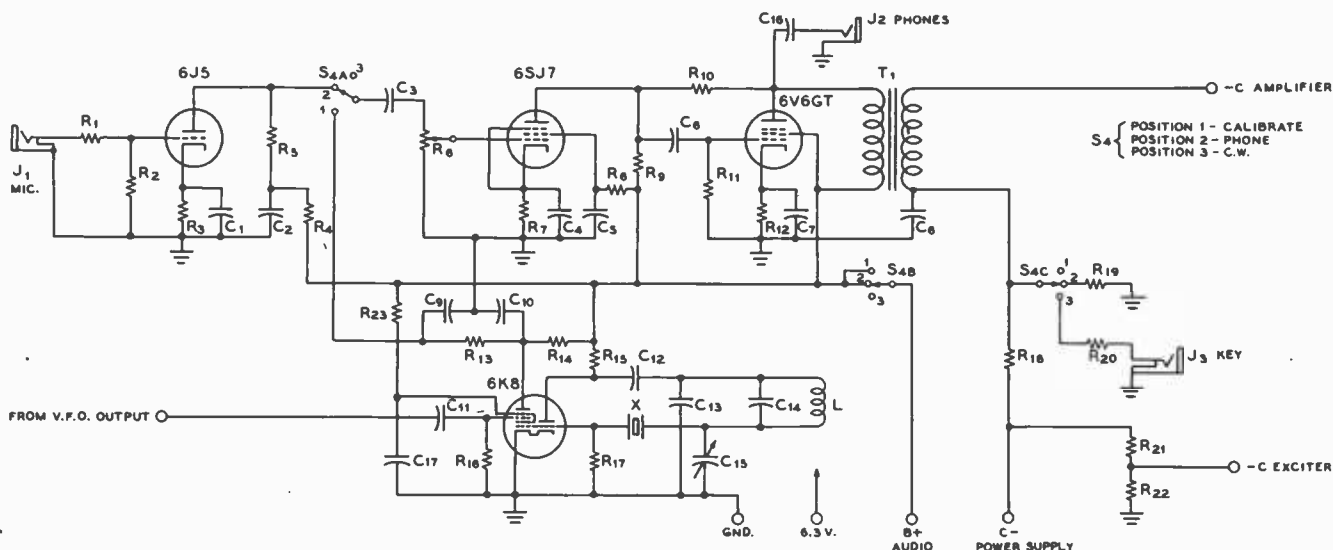

Figure 12.

SCHEMATIC OF THE CRYSTAL CALIBRATOR-AUDIO AMPLIFIER UNIT.

- | | | | |
|---|--|--|---|
| C ₁ —25- μ fd. 25-volt elect. | C ₁₁ —100- μ fd. midget mica | R ₇ —470,000 ohms $\frac{1}{2}$ watt | R ₁₈ —39,000 ohms 2 watts |
| C ₂ —8- μ fd. 450-volt elect. | C ₁₂ —400- μ fd. compression mica | R ₈ —100,000 ohms $\frac{1}{2}$ watt | R ₁₉ —100,000 ohms 2 watts |
| C ₃ —0.1- μ fd. 400-volt tubular | C ₁₃ —0.1- μ fd. 400-volt tubular | R ₉ —47,000 ohms $\frac{1}{2}$ watt | R ₂₀ —4700 ohms 2 watts |
| C ₄ —25- μ fd. 25-volt elect. | C ₁₄ —0.1- μ fd. 400-volt tubular | R ₁₀ —470,000 ohms $\frac{1}{2}$ watt | R ₂₁ —22,000 ohms 2 watts |
| C ₅ —0.1- μ fd. 400-volt tubular | C ₁₅ —1800 ohms 2 watts | R ₁₁ —220,000 ohms $\frac{1}{2}$ watt | R ₂₂ —3300 ohms 2 watts |
| C ₆ —25- μ fd. 25-volt elect. | R ₁ —1.0 megohm $\frac{1}{2}$ watt | R ₁₂ —270 ohms 2 watts | R ₂₃ —100,000 ohms 2 watts |
| C ₇ —8- μ fd. 450-volt elect. | R ₂ —1800 ohms 2 watts | R ₁₃ —47,000 ohms $\frac{1}{2}$ watt | X—100-kc. standard crystal |
| C ₈ —0.003- μ fd. mica | R ₃ —22,000 ohms 2 watts | R ₁₄ —100,000 ohms $\frac{1}{2}$ watt | T ₁ —Multiple match to high-impedance load |
| C ₉ —10- μ fd. midget mica | R ₄ —220,000 ohms $\frac{1}{2}$ watt | R ₁₅ —220,000 ohms $\frac{1}{2}$ watt | L—8-mh. r-f choke |
| C ₁₀ —0.0025- μ fd. midget mica | R ₅ —500,000-ohm potentiometer | R ₁₆ —100,000 ohms $\frac{1}{2}$ watt | |
| | R ₆ —470 ohms 2 watts | R ₁₇ —470,000 ohms $\frac{1}{2}$ watt | |

of the 6K8 in a Colpitts oscillator circuit. The beat signals from the plate circuit of the 6K8 are coupled to the grid of the 6SJ7 second speech stage when control switch S₁ is in the CALIBRATE position. Monitoring phones for using the crystal calibrator are plugged into J₁.

When S₁ is in the PHONE position plate voltage is also applied to the speech amplifier, the 6J5 crystal-microphone amplifier is connected to the grid of the 6SJ7, and a rather high value of bias is placed on the grids of the 807's by R₁₀. Feedback is used from the plate of the 6V6-GT to the plate of the 6SJ7 to improve fidelity and audio regulation of the output of the 6V6-GT.

When S₁ is in the C-W position the audio amplifier is inoperative and the closed-circuit key jack J₃ is connected into the circuit.

Construction All the units of the transmitter previously described are supported from the 12 $\frac{1}{4}$ " by 19" panel of the unit. An aluminum strip is used as a brace between the r-f unit and the crystal-calibrator unit. The power supply, however, is entirely mounted within the main cabinet housing. The main power components are mounted on the floor of the cabinet but the small rectifier tubes, VR tubes, and their associated filament transformers and chokes are mounted on a 7"x13"x2" chassis mounted from rear and right wall of the cabinet above most of the main power supply components.

The exciter unit is mounted on a 7"x11"x2" chassis and the calibrator unit is mounted on a 7"x7"x2" chassis.

A capacitor-input filter is used on the 750-volt power supply and a choke-input filter is used on the 300-volt exciter and audio power supply. A grid-bias supply with a 5Y3-GT rectifier supplies bias to the r-f stages of the transmitter.

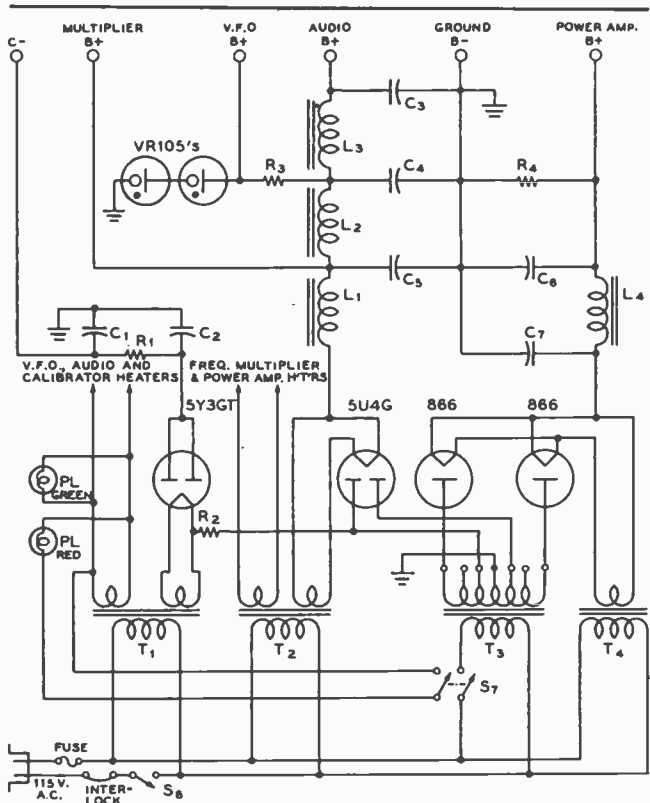

Figure 13.

SCHEMATIC DIAGRAM OF THE POWER-SUPPLY SECTION.

- | | |
|---|--|
| C ₁ , C ₂ , C ₃ , C ₄ —8- μ fd. 450-volt elect. | choke |
| C ₅ —8- μ fd. 500-volt elect. | L ₂ , L ₃ —12 hy. 40-ma. choke |
| C ₆ , C ₇ —2- μ fd. 1000-volt oil | L ₁ —10 hy. 200-ma. filter choke |
| T ₁ , T ₂ —5 v. 6 a., 6.3 v. 5 a. | R ₁ —1000 ohms 10 watts |
| T ₃ —1160 v. c.t. with 600 v. taps, at 500 ma. | R ₂ —5000 ohms 10 watts |
| T ₄ —2.5 volts at 10 amps. | R ₃ —3000 ohms 10 watts |
| L ₁ —5-25 hy. 200-ma. swing | R ₄ —25,000 ohms 50 watts |
| | S ₆ —S.p.s.t. toggle a-c line sw. |
| | S ₇ —D.p.s.t. toggle plate sw. |



Figure 14.
OVERALL VIEW OF THE 813
TRANSMITTER INSTALLA-
TION.

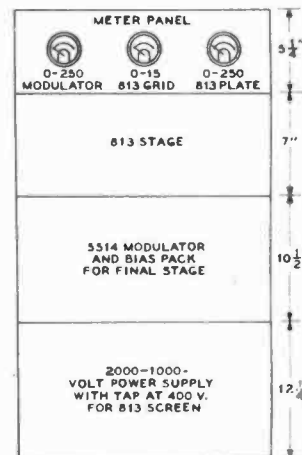

Figure 16.
BLOCK LAYOUT OF COM-
PONENTS IN THE 813
TRANSMITTER.

450-WATT TRANSMITTER WITH 813 FINAL AMPLIFIER

Figures 14 and 15 show a compact 400-watt phone and 450-watt c-w transmitter for operation on all bands from 3.5 through 29.7 Mc. which uses a single 813 beam tetrode in the final-amplifier stage. The actual transmitter housing holds only the final amplifier, the power supplies, and the modulator, as shown in the block layout sketch of Figure 16. This complete transmitter has been assembled from units which are described elsewhere in the book. The final amplifier is described in Chapter 22, the modulator in Chapter 24, and the power supply deck is described in Chapter 25. The meter panel, which completes the transmitter, is a standard manufactured item with a panel height of 5 1/4 inches.

The transmitter has been designed for use with both an external r-f exciter and an external speech amplifier since it is usually desirable to have both these at or near the operating position even when the transmitter itself is at a moderate distance. In the particular installation shown in Figure 14 the 2E26 all-band exciter with a 70E-8 v.f.o. described in Chapter 21 is used as the exciter while the 8-watt 6L6 speech amplifier described in Chapter 24 is used to drive the 5514 Class B modulators. However, any exciter capable of delivering from 3 to 5 watts on the desired bands of operation may be used to excite the 813 final amplifier. Also, any speech amplifier capable of at least 5 or 6 watts audio output with good regulation and low distortion may be used to drive the Class B modulators.

When the transmitter is to be used on c.w. it is only necessary to key the excitation supplied to the 813 since fixed bias supplied to the grid of the 813 and the power supplies have good regulation. The screen voltage on the 813 should be adjusted carefully to a value of 400 volts. Normal grid current on the 813 is 7 to 12 ma. and the plate current should be 200 ma. for phone and 225 ma. for c-w operation.

Figure 15.
REAR VIEW OF THE 450-WATT 813 TRANSMITTER.

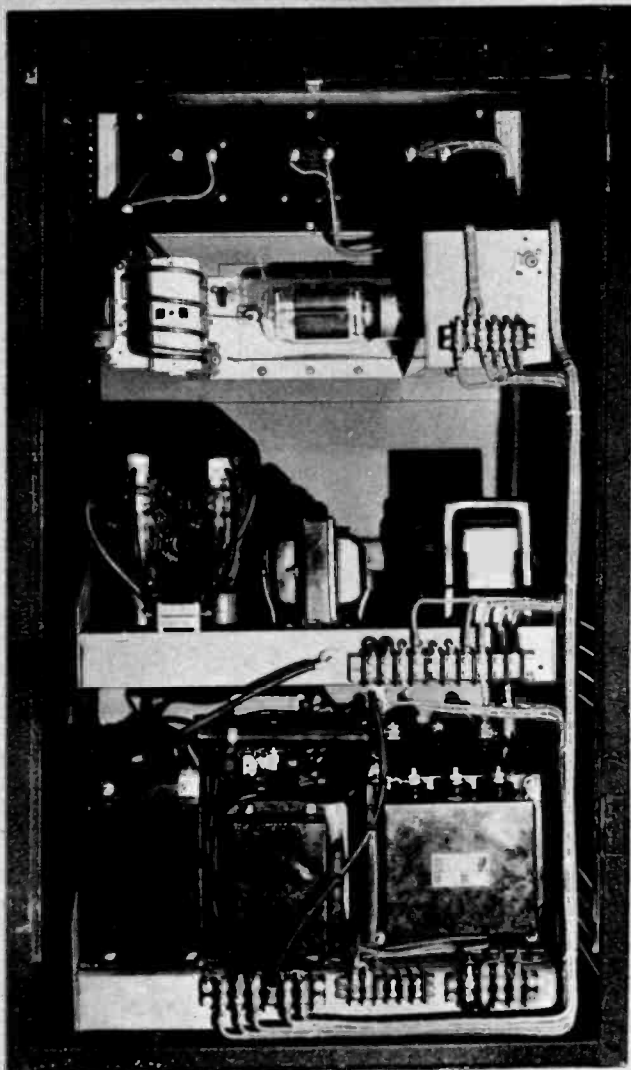

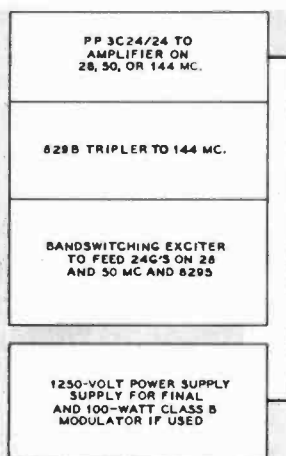
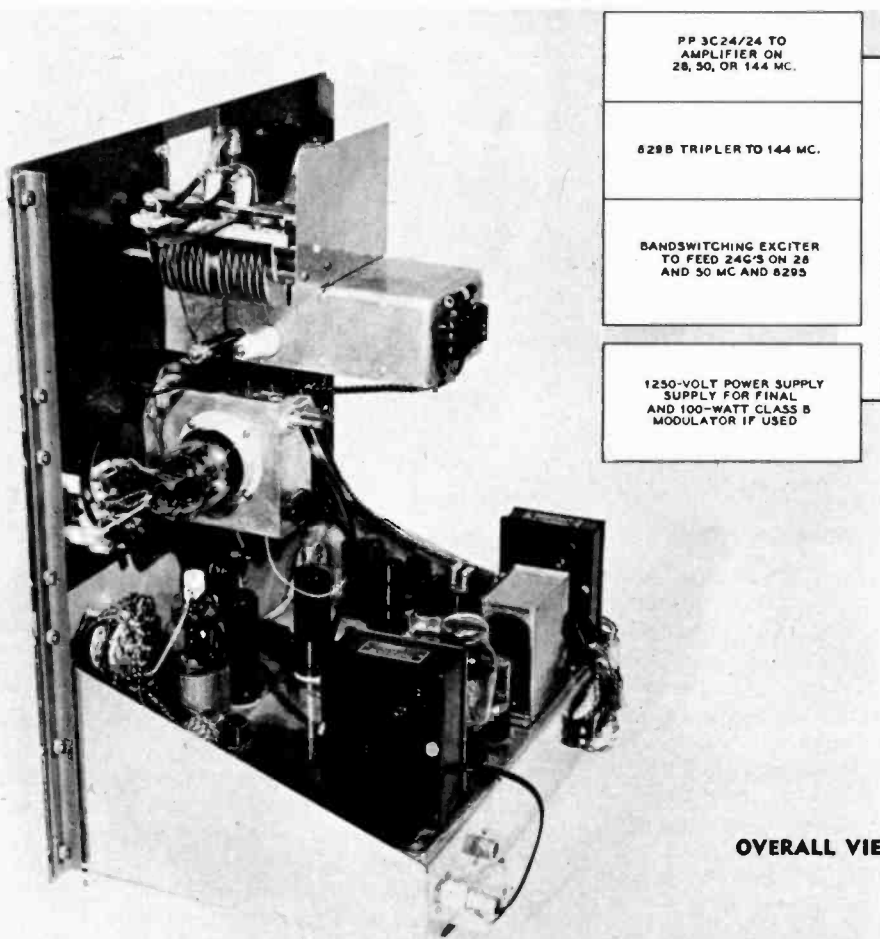

Figure 18.
BLOCK LAYOUT OF THE
3C24/24G R-F ASSEMBLY.

Figure 17.
OVERALL VIEW OF THE R-F ASSEMBLY USING
3C24/24G's.

R-F UNIT FOR 200 WATTS ON 28, 50 AND 144 MC.

The assembly shown in Figure 17 was grouped to show the manner in which the units shown in the various chapters may be mounted in an assembly for obtaining a set of desired operating characteristics. The units which have been grouped are the bandswitching 807 exciter described in Chapter 21, the 829B amplifier/tripler described in Chapter 23, and the push-pull 3C24/24G amplifier described in Chapter 23.

The units have merely been stacked one above the other, with lengths of aluminum angle running vertically on both ends of the panel for support. This mounting arrangement is quite simple and inexpensive, and is very satisfactory where a few light units are to be used in conjunction with a more massive unit. The aluminum angles are first drilled and mounted to the panel of the lower unit. Then the additional units are stacked on top and the holes for the extra panel screws marked and drilled.

With the assembly as shown it is possible to obtain from 25 to 40 ma. of grid current to the 24G's on 10, 6, and 2 meters. The 807 stage in the exciter is used to excite the grids of the final amplifier tubes on 10 and 6, and the 829B stage is used as a tripler to excite the final stage on the 144-Mc. band. Plate voltage for the 829B is obtained from the power supply for the 807 exciter. An external power supply capable of approximately 1250 volts at 160 ma. is required to supply the final amplifier stage. A plate supply with somewhat more

current capability could be used to supply the final amplifier stage and in addition to supply plate voltage to a pair of tubes such as 811's as Class B modulators.

The r-f assembly has operated quite effectively when tested on all three bands mentioned above. The efficiency is somewhat lower on the 144-Mc. band, primarily due to tank circuit heating, but it is still sufficiently good so that a pair of 100-watt lamps may be lighted to good brilliancy by the output of the stage with 200 watts input on this band. In the event that insufficient excitation is obtained on the 50-Mc. band from the 807 doubler, the 829B stage may be used as a straight amplifier on 50 Mc. from the output of the 807.

If desired, the assembly may be used on the lower frequency bands with the 807 exciting the 24G's directly on the 3.5, 7.0, 14, and 21 Mc. frequency ranges. Coil data for operation of the 3C24/24G stage on these lower frequency bands has not been listed in Chapter 23 since standard commercial 150-watt or 250-watt plug-in coils may be employed in the plate circuit of this stage. It will be necessary to use a 25- μ fd. vacuum capacitor across the plate tank circuit of the stage on the 7-Mc. band, and a 50- μ fd. vacuum capacitor should be used in the same circuit position on the 3.5-Mc. band.

Grid coils for operation of the final amplifier on the lower frequency bands may be wound on the same coil forms as used for the v-h-f bands. However, a 25- μ fd. or 50- μ fd. fixed ceramic capacitor should be soldered from grid to grid inside the coil form for the 3.5-Mc. and 7.0-Mc. bands. No padding capacitance is required for 14 Mc. and higher in frequency.

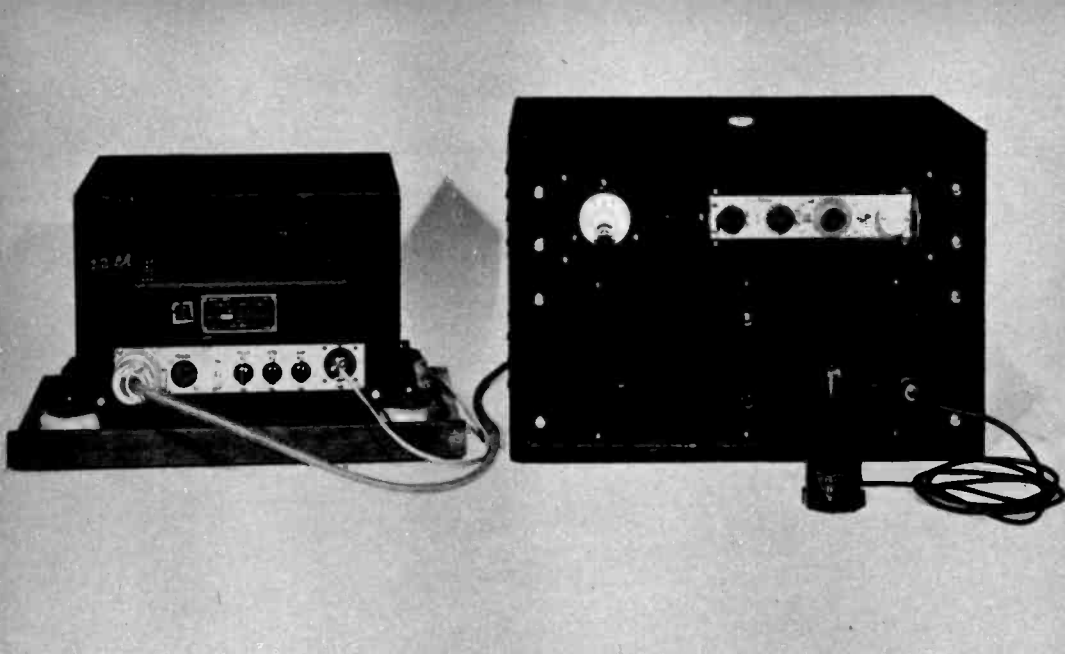

Figure 19.
FRONT VIEW OF THE COMPLETE ASSEMBLY.

The power supply unit to the left is a PE-110-B surplus unit which has been modified as described in Chapter 32. The plug-in r-f drawers are surplus items from the BC-610E transmitter. The modulator for the transmitter is in the lower panel of the rack. The key jack is in the rear of the r-f unit of the transmitter.

40-WATT PHONE/C-W TRANSMITTER

The availability of large quantities of surplus tuning drawers from the BC-610E transmitter along with a manufactured kit of hardware designed around these drawers has made possible the construction of a relatively inexpensive 40-watt exciter or transmitter. The kits of hardware such as shown built up in Figure 20, have been manufactured by Radio Surplus Corp. in Chicago and McElroy Mfg. Corp. in Boston.

A complete transmitter built around one of these kits and using another surplus item, a PE-110B, as a power supply is shown in Figure 19. The assembly is capable of self-contained v-f-o or crystal operation on 80, 40, or 20 and crystal-only operation on the 27 and 28 Mc. bands. A modulator has been included but may be omitted if the r-f portion is to be used as an exciter for a higher powered transmitter.

The Circuit The basic circuit of the exciter unit, using a 6F6 v-f-o or crystal oscillator, a 6L6 multiplier, and an 807 final amplifier, is shown in Figure 22. The standard circuit for the tuning drawers is shown in Figure 23A. The tuning drawers are used without basic circuit change on the 80, 40, and 20 meter bands but the drawer for 10 and 11

meter operation must be more or less completely rebuilt as shown in Figure 23B.

The recommended tuning drawers for operation on the different bands are as follows: 80-meter band, TU-48; 40-meter band, TU-52; 20-meter band, TU-53; and any tuning drawer may be used for the 10 and 11 meter bands since extensive modifications are required.

The TU-48 drawer is modified for 80-meter operation as follows: Remove the wire from original oscillator coil L_0 and clean the ceramic form with carbon tetrachloride. On this form wind 60 turns of no. 30 enameled wire close spaced, bringing out the cathode tap at 15 turns from the grounded end. Add a 6-turn link around the cold end of the amplifier coil L_A . Connect one side of this link coil to the solder lug on the interstage shield and the other end to pin 9 on PL-10. The oscillator tunes from 16 to 62 for 3500-kc. to 4000-kc. output frequency. No jumper is needed in this drawer.

For 40-meter operation it is only necessary to add a four-turn link on L_A connected as in the previous paragraph. The drawer is otherwise used as it stands, except that half the turns should be removed from the oscillator cathode coil if operation with 7-Mc. crystals is desired.

For 20-meter operation a TU-53 unit is modified as follows:

Figure 20.
R-F UNIT OF THE TRANSMITTER.

Kits for constructing an r-f unit such as this to use the tuning drawers from the BC-610E transmitter are available from several sources including the McElroy Mfg. Co.

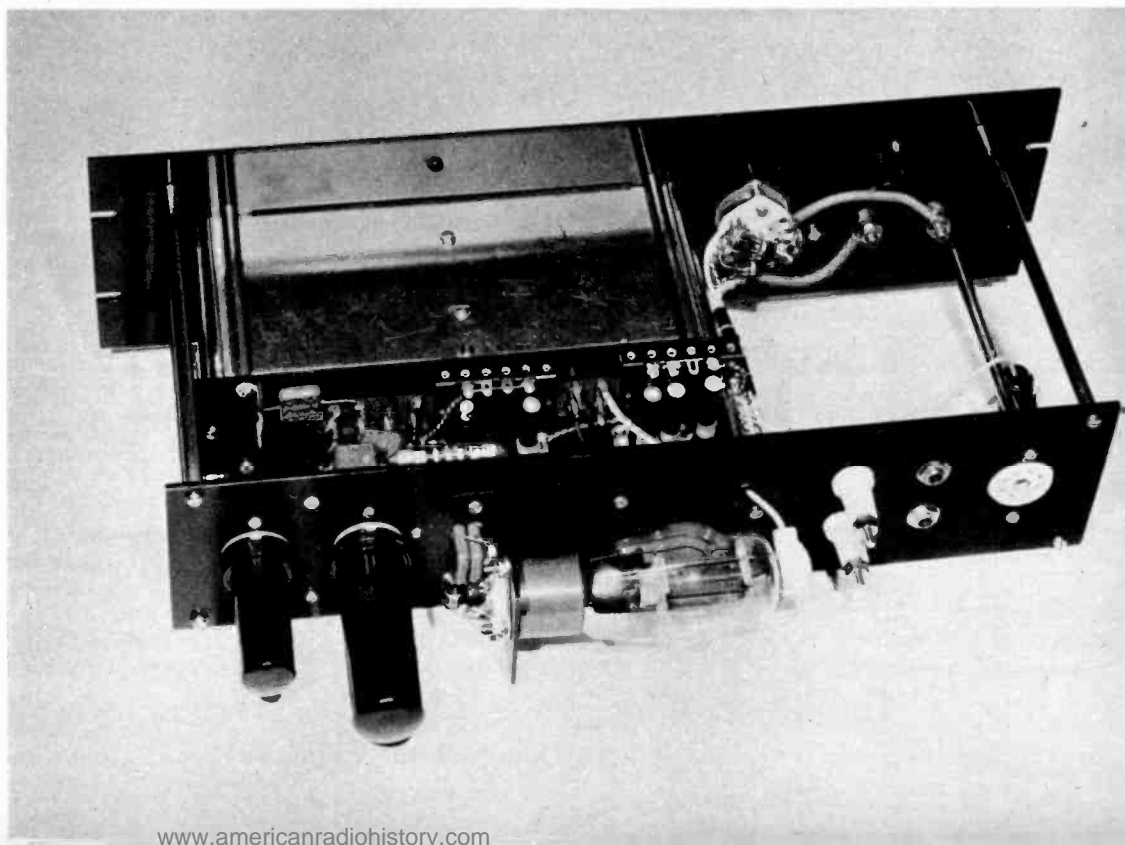
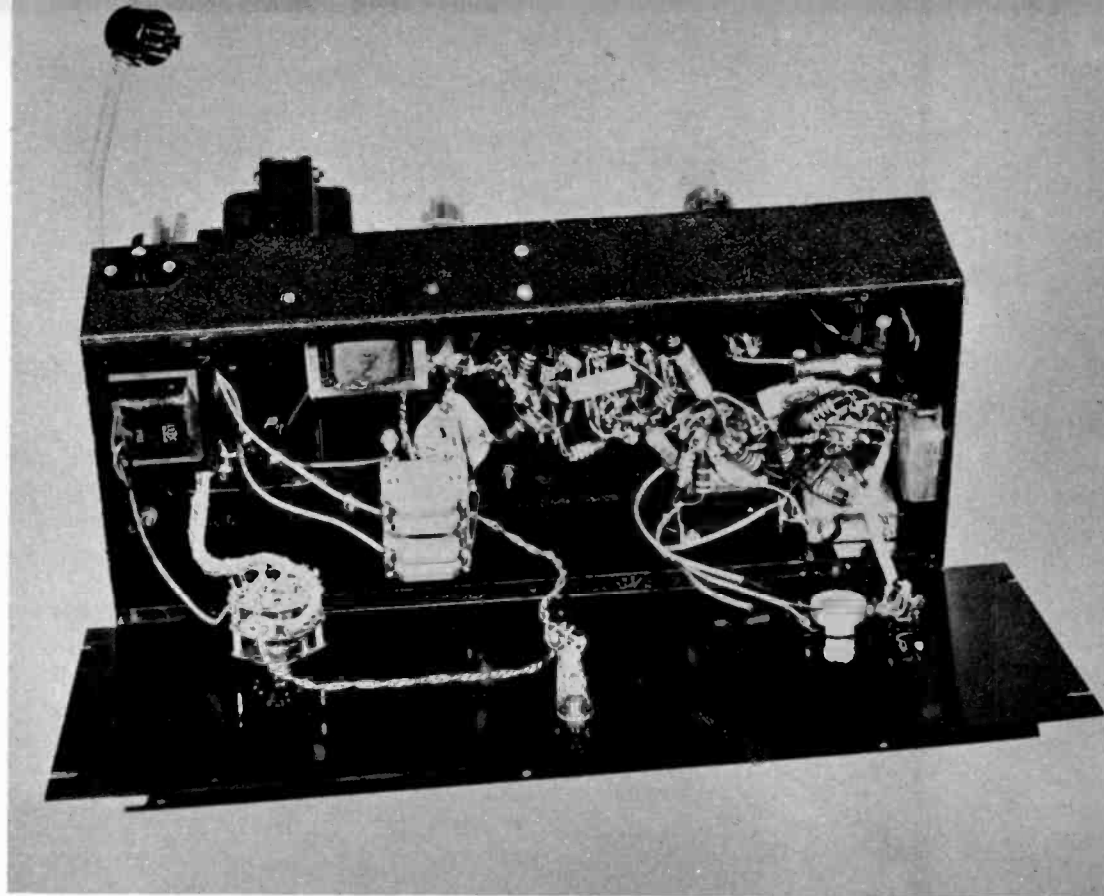

Figure 21.
MODULATOR UNIT OF THE TRANSMITTER.

The chassis for the modulator is mounted vertically, using "dish type" construction. In this view the panel has been removed from the chassis and placed horizontally in front of the chassis with the leads to the panel controls still connected.



Change jumper on PL-10 so that it goes from pin 3 to pin 5. Add a 4-turn link on amplifier coil L_A. Remove half the turns from the oscillator cathode coil for operation of the unit with 40-meter crystals.

For 10 and 11 meter operation any tuning unit may be used since extensive modification is required. Those units with the smaller sizes of tuning capacitors are to be preferred. The circuit of the rebuilt drawer is shown in Figure 23B. With the modification shown v-f-o operation is not possible so the XTAL-VFO switch may be removed and an additional crystal socket for the new 0.486" pin spacing standard crystal installed

in its place. The 6F6 stage is used as a Colpitts oscillator-doubler with a 7.0-Mc. crystal and output on 14 Mc. The 6L6 stage doubles to 28 Mc. and the 807 operates as an amplifier on the output frequency.

The Modulator A pair of 807's are used as a Class AB₂ modulator with the grids of the 807's driven by a 6SN7 cathode follower. The cathodes of the 6SN7 are directly coupled to the grids of the 807's with proper bias being obtained for the 807's by operating the bottom ends of resistors R₁₉ and R₂₀ at -105 volts. Application of the proper

Figure 22.
SCHEMATIC DIAGRAM OF THE R-F UNIT.

- C₁—0.002- μ fd. midget mica
- C₂, C₃—0.003- μ fd. midget mica
- C₄—50- μ fd. midget mica
- C₅, C₆, C₇, C₈—0.002- μ fd. mica
- C₉—0.0001- μ fd. midget mica
- C₁₀, C₁₁—0.002- μ fd. mica
- C₁₂—0.002- μ fd. 1200-volt mica
- C₁₃—0.002- μ fd. midget mica
- R₁—39,000 ohms 2 watts
- R₂—47,000 ohms 2 watts
- R₃—100,000 ohms 2 watts
- R₄—10,000 ohms 10 watts
- R₅—500 ohms 10 watts
- R₆—47,000 ohms 2 watts
- R₇—47 ohms 2 watts
- R₈—200 ohms 10 watts
- R₉, R₁₁, R₁₂—100 ohms 2 watts
- R₁₀—10,000 ohms 10 watts
- R₁₃—10 ohms 10 watts
- RFC₁—10-mh. r-f choke
- RFC₂, RFC₃, RFC₄—2.5-mh. 125 ma.
- S₁—2-pole 3-position switch
- J₁—Exciter keying jack
- J₂—Amplifier keying jack
- J₃—High-voltage connector

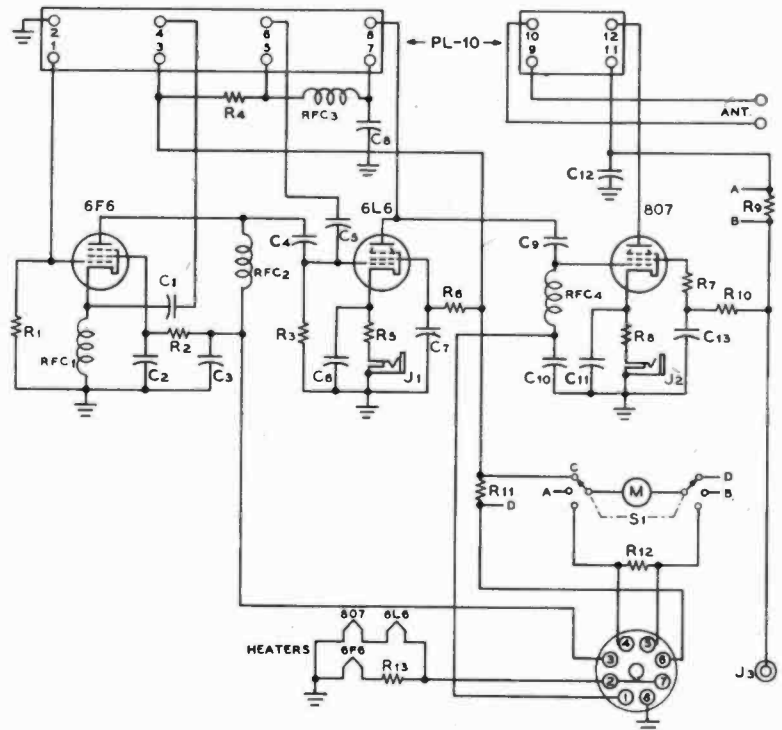

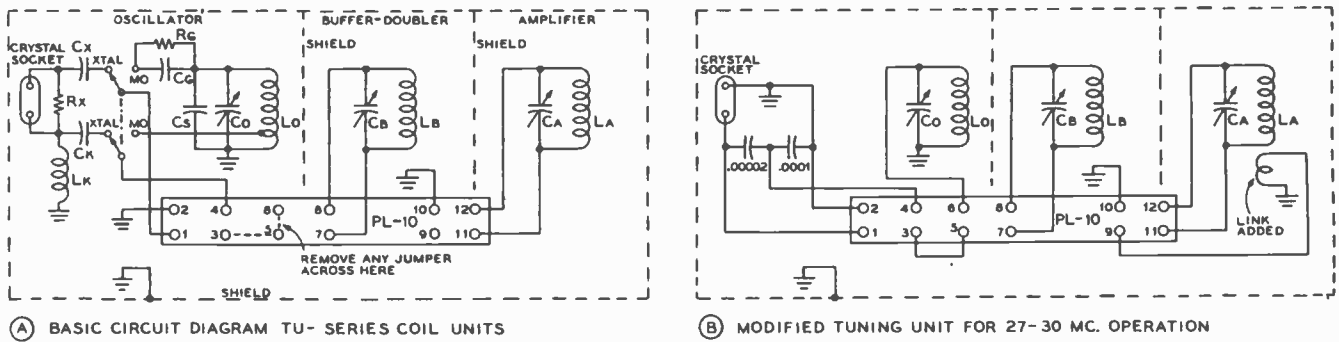

Figure 23. TUNING UNIT SCHEMATIC DIAGRAMS.

The drawing (A) shows the standard connections for the coil units. Note that any jumpers between pins 5 and 6 must be removed for operation with the r-f unit described. Drawing (B) shows how any of the tuning units may be modified for crystal-controlled operation of the 807 as an amplifier on the 28-Mc. band. In this case L₁—12 turns no. 22 enam. 1/2" dia., L_B—XR-2 1" form with 7 turns no. 18 enam., L_A same as L_B but with 3-turn link added.

bias to the 6SN7 grids by the voltage divider R₂₇-R₂₈-R₂₉ causes the correct amount of current to be taken by the 6SN7 plates so that the grids of the 807's run at an average bias of about -30 volts.

The speech system ahead of the cathode-follower driver is more or less conventional using a 6SJ7, a 6J5 phase inverter, and a pair of 6J5's (which may be replaced by a single 6SN7 if desired) as a push-pull amplifier.

Power Supply The correct power supply for operation of the transmitter is the modified PE-110B unit described in Chapter 32. However, note that resistor R_A shown in the schematic of this power supply is not used since the VR-105 tube in the modulator unit replaces this resistor. Any power supply delivering 475 volts at about 225 ma. and 350 volts at 40 ma. with the control circuits shown will be suitable for operation of the equipment.

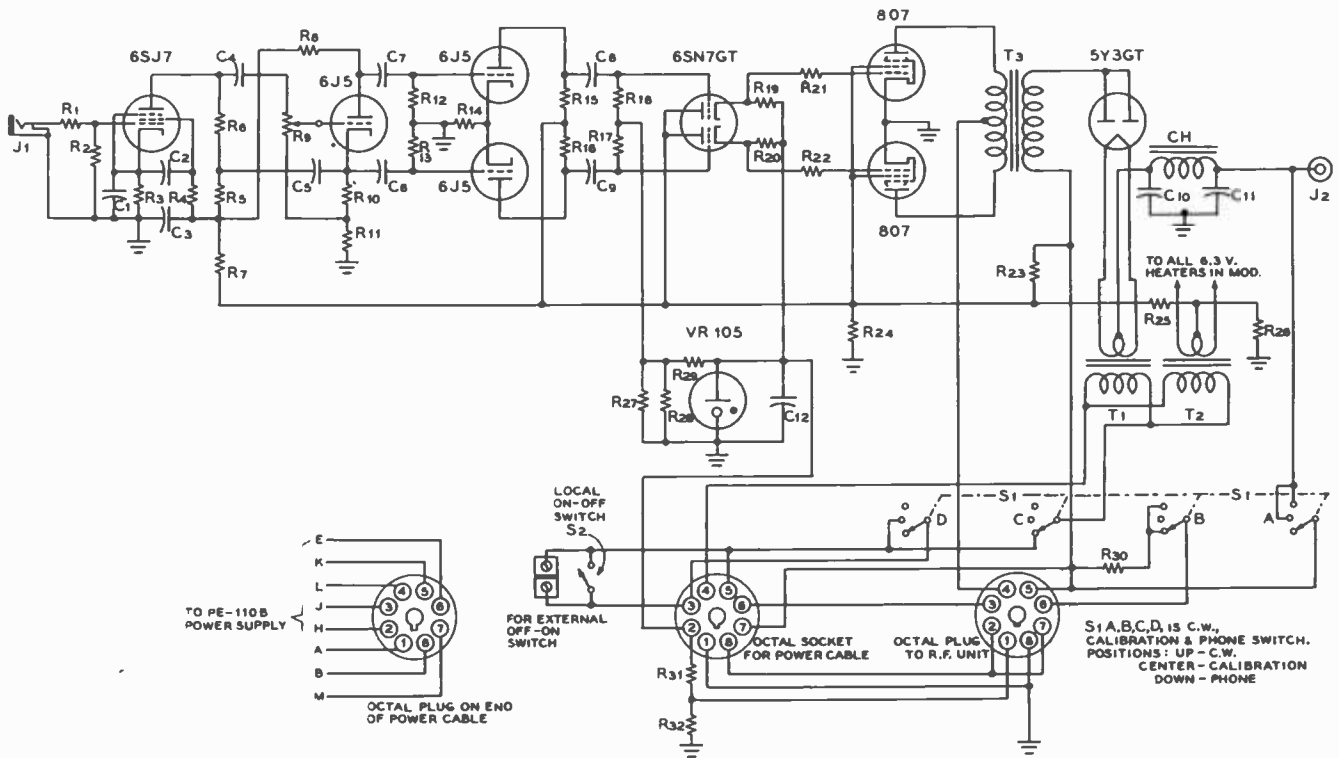

Figure 24.

SCHEMATIC DIAGRAM OF THE MODULATOR UNIT.

- | | | | |
|---|---|--|--|
| C ₁ —25-μfd. 25-volt elect. | R ₁ —47,000 ohms 1/2 watt | R ₁₂ , R ₁₅ —470,000 ohms 1/2 watt | R ₂₉ —47,000 ohms 2 watts |
| C ₂ —0.5-μfd. 400-volt tubular | R ₂ —470,000 ohms 1/2 watt | R ₁₄ —1000 ohms 2 watts | R ₃₀ —3000 ohms 10 watts |
| C ₃ —8-μfd. 450-volt elect. | R ₃ —1800 ohms 1/2 watt | R ₁₇ , R ₁₈ —47,000 ohms 2 watts | R ₃₁ —39,000 ohms 2 watts |
| C ₄ —0.003-μfd. mica | R ₄ —1.0 megohm 1/2 watt | R ₁₉ , R ₂₀ —470,000 ohms 1/2 watt | R ₃₂ —22,000 ohms 2 watts |
| C ₅ —1.0-μfd. 400-volt tubular | R ₅ —39,000 ohms 2 watts | R ₂₁ , R ₂₂ —22,000 ohms 2 watts | T ₁ —5 volts 3 amps |
| C ₆ , C ₇ —0.01-μfd. 400-volt tubular | R ₆ —220,000 ohms 2 watts | R ₂₃ , R ₂₄ —470 ohms 2 watts | T ₂ —6.3 volts 6 amps |
| C ₈ , C ₉ —0.01-μfd. 400-volt tubular | R ₇ —39,000 ohms 2 watts | R ₂₅ —5000 ohms 10 watts | T ₃ —50-watt modulation transformer |
| C ₁₀ , C ₁₁ —0.01-μfd. 400-volt tubular | R ₈ —22,000 ohms 2 watts | R ₂₆ —10,000 ohms 10 watts | CH—0.5 henry 125-ma. choke |
| C ₁₂ —0.02-μfd. 1250-volt mica | R ₉ —500,000-ohm potentiometer | R ₂₇ —470,000 ohms 1/2 watt | S ₁ —4-pole 3-position switch |
| | R ₁₀ —3300 ohms 2 watts | R ₂₈ —47,000 ohms 1/2 watt | S ₂ —S.p.s.t. switch |
| | R ₁₁ —39,000 ohms 2 watts | R ₂₉ , R ₃₀ —39,000 ohms, 2 watts | |

Lower Frequency Antennas

DUE to space limitations, antennas for the 3.5-Mc. and 7-Mc. bands as used by the average amateur usually consist of a relatively simple doublet radiator. Consequently, this chapter will be devoted to discussions of the practical use of the doublet antenna, relatively minor variations upon the doublet principle, and methods for feeding such antenna systems.

27-1 End-Fed Half-Wave Horizontal Antennas

The half-wave horizontal dipole is the most common and the most practical antenna for the 3.5-Mc. and 7-Mc. amateur bands. The form of the dipole and the manner in which it is fed are capable of a large number of variations. Figure 1 shows a number of practicable forms of the simple dipole antenna along with methods of feed.

Usually a high-frequency doublet is mounted as high and as much in the clear as possible, for obvious reasons. However, it is sometimes justifiable to bring part of the radiating system directly to the transmitter, feeding the antenna without benefit of a transmission line. This is permissible when (1) there is insufficient room to erect a 75- or 80-meter horizontal dipole and feed line, (2) when a long wire is operated on one of the higher frequency bands on a harmonic. In either case, it is usually possible to get the main portion of the antenna in the clear because of its length. This means that the power lost by bringing the antenna directly to the transmitter is relatively small.

Even so, it is not best practice to bring the high-voltage end of an antenna into the operating room, especially for 'phone operation, because of the possibility of r-f feedback from the strong antenna field. For this reason we dispense with a feed line in conjunction with a Hertz antenna only as a last resort.

End-Fed Antennas The end-fed antenna has no form of transmission line to couple it to the transmitter, but brings the radiating portion of the antenna right down to the transmitter, where some form of coupling system is used to transfer energy to the antenna.

This antenna always is voltage-fed, and always consists of an *even* number of quarter-wavelengths. Figure 1 shows several common methods of feeding the Fuchs antenna or "end-fed Hertz." Arrangement "C" is to be recommended to minimize

harmonics, as an end-fed antenna itself offers no discrimination against harmonics, either odd or even.

The Fuchs type of antenna has rather high losses unless at least three-quarters of the radiator can be placed outside the operating room and in the clear. As there is high r-f voltage at the point where the antenna enters the operating room, the insulation at that point should be several times as effective as the insulation commonly used with low-voltage feeder systems. This antenna can be operated on all of its higher harmonics with good efficiency, and can be operated at half frequency against ground as a quarter-wave Marconi.

As the frequency of an antenna is raised slightly when it is bent anywhere except at an exact voltage or current loop, an end-fed Hertz antenna usually is a few per cent longer than a straight half-wave doublet for the same frequency, because, ordinarily, it is impracticable to bring a wire in to the transmitter without making several bends.

The Zepp Antenna System The zeppelin or "zepp" antenna system, illustrated in Figure 2A and in Figure 3, is very commonly used when it is desired to operate a single radiating wire on a number of harmonically related frequencies.

The zepp antenna system is easy to tune up, and can be used on several bands by merely retuning the feeders. The overall efficiency of the zepp antenna system is probably not quite as high for long feeder lengths as for some of the antenna systems which employ nonresonant transmission lines, but where space is limited and where operation on more than one band is desired, the zepp has some decided advantages.

Zepp feeders really consist of an additional length of antenna which is folded back on itself, so that the radiation from the two halves cancels. In Figure 3A is shown a simple Hertz antenna, fed at the center by means of a pickup coil. Figure 3B shows another half-wave radiator tied directly on one end of the radiator shown in Figure 3A. Figure 3C is exactly the same thing, except that the first half-wave radiator, in which is located the coupling coil, has been folded back on itself. In this particular case, each half of the folded part of the antenna is exactly a quarter-wave long electrically.

Addition of the coupling coil naturally will electrically lengthen the antenna; thus, in order to bring this portion of

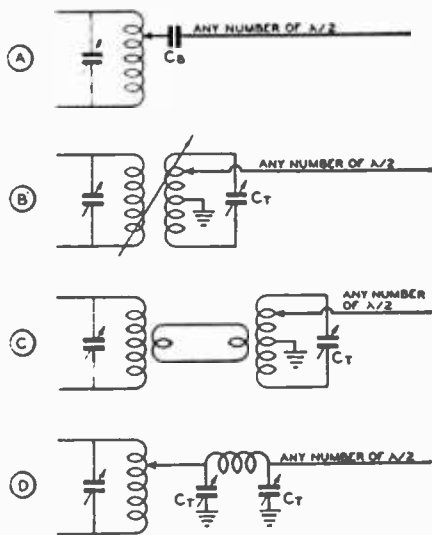

Figure 1.

FOUR METHODS OF END FEEDING AN ANTENNA.

The arrangement at (C) is to be recommended since rejection of undesired harmonic radiation will be greatest with this circuit arrangement. The arrangement at (D) may be used under certain conditions when a single-ended amplifier stage is used in the output of the transmitter.

the antenna back to resonance, we must electrically shorten it by means of the series tuning capacitor, C_s . The two wires in the folded portion of the antenna system do not have to be exactly a quarter wave long physically, although the total electrical length of the folded portion must be equal to one-half wavelength electrically.

When the total electrical length of the two feeder wires, plus the coupling coil, is slightly greater than any odd multiple of one-quarter wave, then series tuning capacitors must be used to shorten the electrical length of the feeders sufficiently to establish resonance. If, on the other hand, the electrical length of the feeders and the coupling coil is slightly less than any odd multiple of one-quarter wave, then parallel tuning (wherein a variable capacitor is shunted across the coupling coil) must be used in order to increase the electrical length of the whole feeder system to a multiple of one-quarter wavelength.

As the radiating portion of the zapp antenna system must always be some multiple of a half wave long, there is always high voltage present at the point where the live zapp feeder attaches to the end of the radiating portion of the antenna. Thus, this type of zapp antenna system is *voltage fed*.

The idea that it takes two capacitors to balance the current in the feeders, one capacitor in each feeder, is a common misconception regarding the zapp-type end-fed antenna. Balancing the feeders with tuning capacitors for equal currents is useless, anyhow, inasmuch as the feeders on an end-fed zapp can never be balanced for both current and phase because of the tendency for the end of the "dead" feeder to have more voltage on it than the one attached to the radiator.

Flat Top Length The correct physical length for the flat top (radiating portion) of a zapp is *not* 0.95 of a half wavelength. Instead, it is so close to a half wavelength that it may be taken as that figure. Thus, while a 7300-kc. doublet is 64 feet long, the flat top of a 7300-kc. zapp should be 67 feet 3 inches. The reason for this is apparent when it is remembered that the 5 per cent difference between a resonant doublet and a physical half wavelength is principally due to "end effects," 2½ per cent at each end of the radiator.

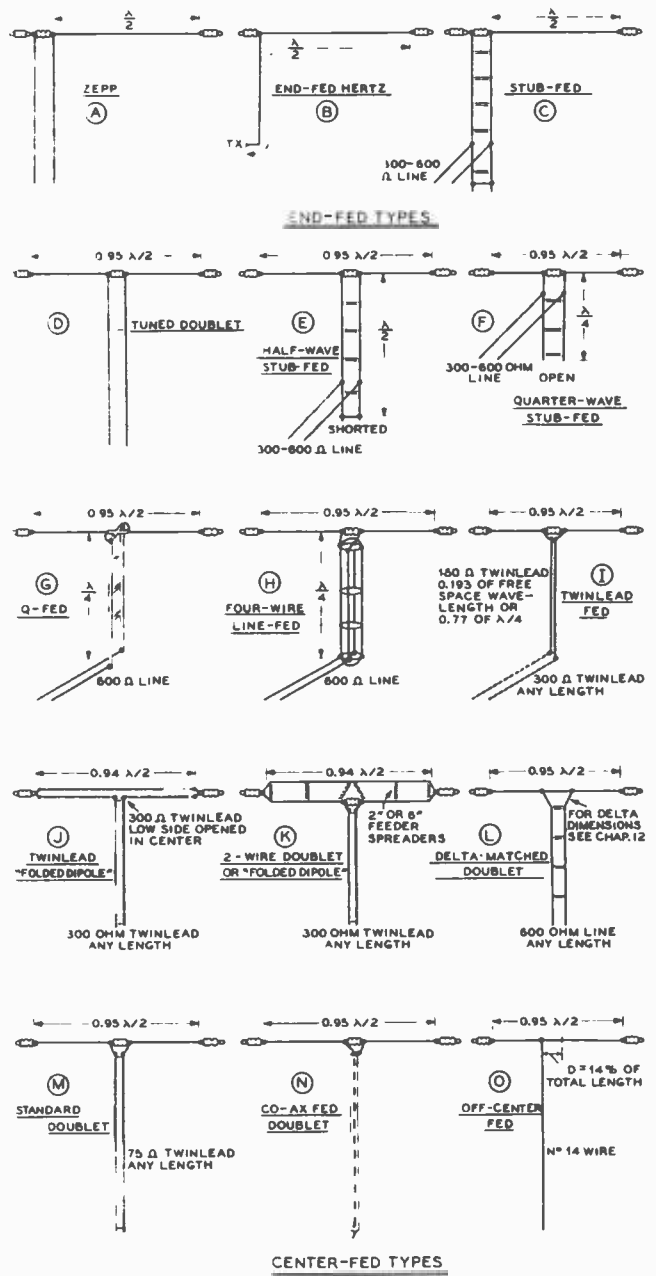

Figure 2.

ALTERNATIVE METHODS OF FEEDING A HALF-WAVE DIPOLE.

The feed systems shown at (A), (B) and (C) above are of greatest advantage when it is required to locate the transmitter adjacent to one end of the radiating wire. The other illustrations of Figure 2 show a large number of permissible methods of center feeding a half-wave dipole. The various feed methods are described in detail in the accompanying text.

Obviously there is no end effect at the end of a radiator to which zapp feeders are attached. Hence, we lengthen the radiator 2½ per cent. Now we must take into consideration that the end of the "dead" (unattached) feed wire has end effects, and that the other feeder does not. We want the two voltage loops to come at the same point on the feed line in order to obtain the best possible balance so as to minimize radiation. So we make the dead feed wire 2½ per cent of a half wavelength shorter than the other. This can be done quite easily, merely by lengthening the flat top another 2½ per cent. Thus the flat top is 5 per cent longer than if it were fed in the center.

Stub-Fed Zepp-Type Radiator Figure 2C shows a modification of the zepp-type antenna system to allow the use of a non-resonant transmission line between the radiating portion of the antenna and the transmitter. The "zepp" portion of the antenna is resonated as a quarter-wave stub and the non-resonant feeders are connected to the stub at a point where standing waves on the feeder are minimized. The procedure for making these adjustments is described in detail in Chapter 12. This type of antenna system is quite satisfactory when it is necessary physically to end feed the antenna, but where it is necessary also to use non-resonant feeder between the transmitter and the radiating system.

27-2 Center-Fed Half-Wave Horizontal Antennas

The center feeding of a half-wave antenna system is usually to be desired over an end-fed system since the center-fed system is inherently balanced to ground and is therefore less likely to be troubled by feeder radiation. A number of center-fed systems are illustrated in Figure 2.

The Tuned Doublet The current-fed doublet with spaced feeders, sometimes erroneously called a center-fed zepp, is an inherently balanced system if the two legs of the radiator are electrically equal. This fact holds true regardless of the frequency, or of the harmonic, on which the system is operated. The system can successfully be operated over a wide range of frequencies if the system as a whole (both tuned feeders and the center-fed flat top) can be resonated to the operating frequency. It is usually possible to tune such an antenna system to resonance with the aid of a tapped coil and a tuning capacitor that can optionally be placed either in series with the antenna coil or in parallel with it. A series tuning capacitor can be placed in series with one feeder leg without unbalancing the system if the capacitor is placed in the immediate vicinity of the antenna coil.

This type of antenna system is shown in Figure 2D. The antenna is a current-fed system when the radiating wire is a half wave long electrically, or when the system is operated on its odd harmonics, but becomes a voltage-fed radiator when operated on its even harmonics.

The antenna has a different radiation pattern when operated on its harmonics, as would be expected. The arrangement used on the second harmonic is better known as the Franklin colinear array and is described in Chapter 28. The pattern is similar to a half-wave dipole except that it is sharper in the broadside direction. On higher harmonics of operation there will be multiple lobes of radiation from the system.

Figures 2E and 2F show alternative arrangements for using an untuned transmission line between the transmitter and the tuned-doublet radiator. In Figure 2E a half-wave shorted line is used to resonate the radiating system, while in Figure 2F a quarter-wave open line is utilized. The adjustment of quarter-wave and half-wave stubs is discussed in Chapter 12.

Doublets with Quarter-Wave Transformers The average value of feed impedance for a center-fed half-wave doublet is 75 ohms. The actual value varies with height and is shown in Figure 3 of Chapter 12. Alternative methods of matching this rather low value of impedance to a medium-impedance transmission line are shown in (G), (H), and (I) of Figure 2. Each of these three systems uses a quarter-wave transformer to accomplish the impedance transformation. The only difference between the three systems lies in the type of transmission line used in the quarter-wave transformer. (G) shows the "Johnson Q" system whereby a line made up of 1/2-inch dural tubing is used for the low-

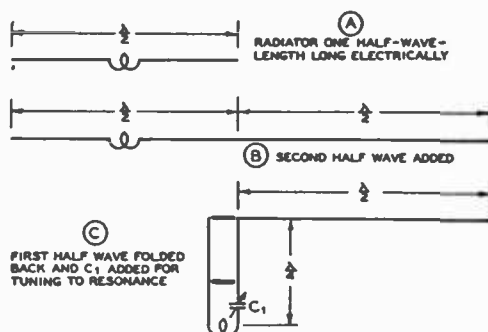

Figure 3. EVOLUTION OF THE ZEPP ANTENNA.

impedance linear transformer. A line made up in this manner is frequently called a set of "Q bars". Illustration (H) shows the use of a four-wire line as the linear transformer, and (I) shows the use of a piece of 150-ohm twinlead electrically $\frac{1}{4}$ -wave in length as the transformer between the center of the dipole and a piece of 300-ohm twinlead. In any case the impedance of the quarter-wave transformer will be of the order of 150 to 200 ohms. The use of sections of transmission line as linear transformers is discussed in detail in Chapter 12.

Multi-Wire Doublets An alternative method for increasing the feed-point impedance of a dipole so that a medium-impedance transmission line may be used is shown in Figures 2J and 2K. This system utilizes more than one wire in parallel for the radiating element, but only one of the wires is broken for attachment of the feeder. The theory of this type of antenna has been discussed in Chapter 12, but the most common arrangement uses two wires in the flat top of the antenna so that an impedance multiplication of four is obtained.

The antenna shown in Figure 2J is the so-called twinlead "folded dipole" which is so popular an antenna system on the medium-frequency amateur bands. In this arrangement both the antenna and the transmission line to the transmitter are constructed of 300-ohm twinlead. The flat top of the antenna is made slightly less than the conventional length ($462/F_{Mc}$ instead of $468/F_{Mc}$ for a single-wire flat top) and the two ends of the twinlead are joined together at each end. The center of one of the conductors of the twinlead flat top is broken and the two ends of the twinlead feeder are spliced into the flat top leads. As a protection against moisture pieces of flat polyethylene taken from another piece of 300-ohm twinlead may be molded over the joint between conductors with the aid of an electric iron or soldering iron.

Figure 2K shows the basic type of 2-wire doublet or "folded dipole" wherein the radiating section of the system is made up of standard antenna wire spaced by means of feeder spreaders. The feeder, again is made of 300-ohm twinlead since the feed-point impedance is approximately 300 ohms the same as that of the twinlead folded dipole.

The folded-dipole type of antenna has the broadest response characteristic (greatest bandwidth) of any of the conventional half-wave antenna systems constructed of small wires or conductors. Hence such an antenna may be operated over the greatest frequency range without producing detuning at the transmitter of any common half-wave antenna type.

The increased bandwidth of the multi-wire doublet type of radiator, and the fact that the feed-point resistance is increased several times over the radiation resistance of the element, have both contributed to the frequent use of the multi-wire radiator as the driven element in a parasitic antenna array.

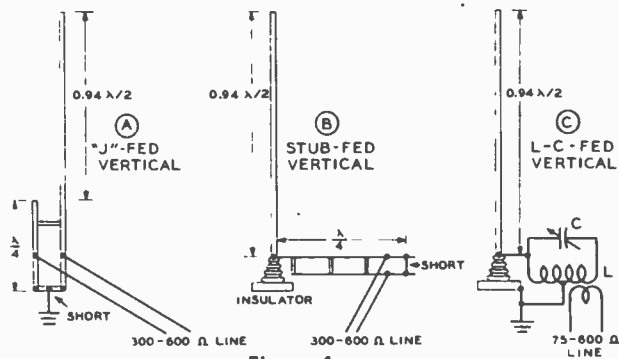

Figure 4.

HALF-WAVE VERTICAL ANTENNA SHOWING ALTERNATIVE METHODS OF FEED.

Some trouble has been experienced with twinlead from moisture absorption. Amphenol has recently announced the availability of "Amphenol 307 Silicone Compound", a substance which may be coated on the twinlead in the thinnest possible film to prevent the formation of a continuous film of moisture on the surface of the twinlead. It has been stated that this material will greatly reduce the ill effects of moisture on the operation of twinlead transmission line.

Delta-Matched Doublet and Standard Doublet These two types of radiating elements are shown in Figure 2L and Figure 2M. The delta-matched doublet is described in detail in Chapter 12 and is illustrated in

Figure 15 of that chapter. The standard doublet, shown in Figure 2M, is fed in the center by means of 75-ohm twinlead, either the transmitting or the receiving type, or it may be fed by means of twisted-pair feeder or by means of parallel-wire lampcord. Any of these types of feed line will give an approximate match to the center impedance of the dipole, but the 75-ohm twinlead is far to be preferred over the other types of feeder due to the much lower losses of the polyethylene-dielectric transmission line.

The coaxial-cable-fed doublet shown in Figure 2N is a variation on the system shown in Figure 2M. Either 52-ohm coaxial cable or 75-ohm coaxial cable may be used to feed the center of the dipole, although the 75-ohm type will give a somewhat better impedance match at normal antenna heights. Due to the asymmetry of the coaxial feed system difficulty may be encountered with waves traveling on the outside of the coaxial cable. For this reason the use of twinlead is normally to be preferred over the use of coaxial cable for feeding the center of a half-wave dipole.

Off-Center Fed Doublet The system shown in Figure 2(O) is sometimes used to feed a half-wave dipole, especially when it is desired to use the same antenna on a number of harmonically-related frequencies. The feeder wire (no. 14 enamelled wire should be used) is tapped a distance of 14 per cent of the total length of the antenna either side of center. The feeder wire, operating against ground for the return current, has an impedance of approximately 600 ohms. The system works well over highly conducting ground, but will introduce rather high losses when the antenna is located above rocky or poorly conducting soil. The off-center fed antenna has a further disadvantage that it is highly responsive to harmonics fed to it from the transmitter. This means that an effective harmonic filter circuit such as is described in Chapter 10 must be used between the transmitter and the feed line to the antenna.

The effectiveness of the antenna system in radiating harmonics is of course an advantage when operation of the an-

tenna on a number of frequency bands is desired. But again it is quite necessary to use a harmonic filter to insure that only the desired frequency is fed from the transmitter to the antenna.

27-3 Half-Wave Vertical Antennas

The half-wave vertical antenna with its bottom end from 0.1 to 0.25 wavelength above ground is a very effective dx antenna under operating conditions where man-made interference is not too severe, and where the ground conditions in the vicinity of the antenna are particularly good. Such an antenna will operate very effectively over water or salt marsh, or a system of radials from one-half wavelength to two wavelengths in length may be run out, spaced from 15° to 45°, from the base of the antenna.

Figure 4 shows three ways of feeding such an antenna system by means of an untuned transmission line. Of course zepp feeders may be run to the base of the antenna under conditions where zepp feeders are practicable. The system shown in Figure 4A is quite desirable under certain conditions since the base of the antenna section may be grounded—hence an insulator is not needed at the base of the structure. Of course a vertical section actually $\frac{3}{4}$ wavelength long must be used, while only the top $\frac{1}{2}$ wavelength does the radiating. However, the arrangement is convenient when a $\frac{3}{4}$ -wavelength section of dural tubing may be solidly mounted at the base and left self-supporting for most of its extent. The system is also convenient for mobile work on the higher-frequency bands since the base of the radiating structure may be mounted to the frame of the car or to the bumper.

The stub-fed vertical system shown in Figure 4B is an arrangement similar in principle to the system shown at (A) except that the matching section is not made a part of the supporting structure of the radiating element. This arrangement, as well as that shown at (C) requires the use of an insulator at the base of the antenna. The tuning procedure for the stub, and the method for determining the proper tap position for the transmission line has been discussed in Chapter 12. If a coil and capacitor (mounted in a weatherproof box) is used at the base of the antenna instead of the matching stub, the tuning procedure is as follows: It is assumed first that the length of the radiating portion of the antenna is approximately one-half wavelength (or any multiple of one-half wavelength) in length. The coil and capacitor are first resonated, using a neon bulb or dial lamp and loop of wire as an indicator, without the antenna connected and with very loose coupling to the feed line from the transmitter. Then the antenna is connected, the coupling to the feeder line is increased, and the tank circuit is checked for resonance. The tank will probably have to be retuned slightly due to the capacitance to ground of the base of the antenna. Then the adjustments of the links at the transmitter and at the antenna coupling tank are successively readjusted until the transmitter is loaded to the proper input and the feed line shows a low standing-wave ratio.

27-4 The Marconi Antenna

A grounded quarter-wave Marconi antenna is sometimes used on the 80-meter band, and is also used in v-h-f mobile services where a compact antenna is required. The Marconi type antenna allows the use of half the length of wire that would be required for a half-wave Hertz radiator. The ground acts as a mirror, in effect, and takes the place of the additional quarter-wave of wire that would be required to reach resonance if the end of the wire were not returned to ground.

The Marconi antenna is generally not as satisfactory for long-distance communication as the Hertz type, the reduced radiation efficiency being due to losses in the ground connec-

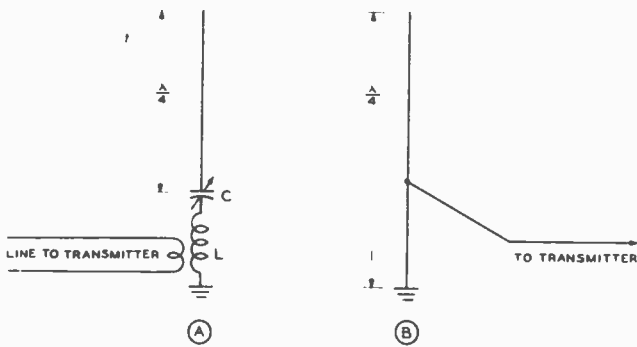

Figure 5.

TWO PRACTICAL METHODS OF FEEDING A QUARTER-WAVE MARCONI ANTENNA.

The arrangement shown at (A) is preferable where the lower end of the Marconi antenna is not grounded. However, the shunt feeding system shown at (B) will be found to be quite satisfactory for use in cases where the lower end of the radiator must necessarily be grounded for mechanical reasons.

tion. However, the Marconi may be made almost as good a radiator on frequencies below about 3 Mc. if sufficient care is taken with regard to the ground system.

The fundamental practical form of the Marconi antenna system is shown in Figure 5A. Other Marconi antennas differ from this type primarily in regard to the method of feeding the energy to the radiator. The feed method shown in Figure 5B can often be used to advantage, particularly in mobile work, when it is desired to ground the bottom of the Marconi antenna.

Variations on the basic Marconi antenna shown in Figure 6A are shown in the other illustrations of Figure 6. Figures 6B and 6C show the "L"-type and "T"-type Marconi antennas. These arrangements have been more or less superseded by the top-loaded forms of the Marconi antenna shown in Figures 6D, 6E, and 6F. In each of these latter three figures an antenna somewhat less than one quarter wave in length has been loaded to increase its effective length by the insertion of a loading coil at or near the top of the radiator. The arrangement shown at Figure 6D gives the least loading but is the most practical mechanically. The system shown at Figure 6E gives an intermediate amount of loading, while that shown at Figure 6F, utilizing a "hat" just above the loading coil, gives the greatest amount of loading. The object of all the top-loading methods shown is to produce an increase in the effective length of the radiator, and thus to raise the point of maximum current in the radiator as far as possible above ground. Raising the maximum-current point in the radiator above ground has two desirable results: The percentage of low-angle radiation is increased and the amount of ground current at the base of the radiator is reduced, thus reducing the ground losses.

Loading Coils To resonate inductively an inductive-loaded Marconi, the inductance would have to be in the form of a variometer in order to permit continuous variation of the inductance. The more common practice is to use a tapped loading coil. The loading coil should preferably be placed a short distance from the top or far end of the radiator; this reduces the current flowing in the ground connection by raising the radiation resistance, resulting in better radiation efficiency. More than the required amount of inductance for resonance is clipped in series with the antenna, and the system is then resonated by means of the series variable capacitor at the base of the radiator, the same as though the radiator were actually too long physically.

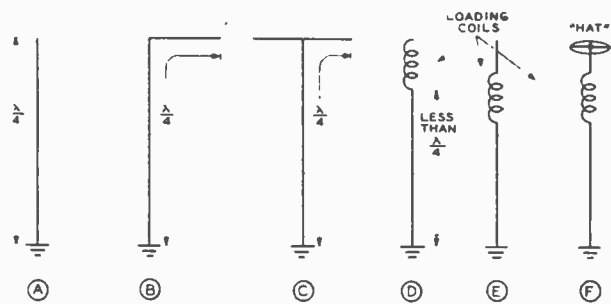

Figure 6.

VARIATIONS ON THE MARCONI ANTENNA.

The relative advantages of the top loading systems as shown at (B), (C), (E) and (F) are discussed in text.

To estimate whether a loading coil will probably be required, it is necessary only to note if the length of the antenna wire and ground lead is over a quarter wavelength; if so, no loading coil is needed, provided the series tuning capacitor has a high maximum capacitance.

Amateurs primarily interested in the higher frequency bands, but who like to work 80 meters occasionally, can usually manage to resonate one of their antennas as a Marconi by working the whole system, feeders and all, against a water pipe ground, and resorting to a loading coil if necessary. A high-frequency-rotary, zepp, doublet, or single-wire-fed antenna will make quite a good 80-meter Marconi if high and in the clear, with a rather long feed line to act as a radiator on 80 meters. Where two-wire feeders are used, the feeders should be tied together for Marconi operation.

Importance of Ground Connection With a quarter-wave antenna and a ground, the antenna current generally is measured with a meter placed in the antenna circuit close to the ground connection. Now, if this current flows through a resistor, or if the ground itself presents some resistance, there definitely will be a power loss in the form of heat. Improving the ground connection, therefore, provides a definite means of reducing this power loss, and thus increasing the radiated power.

The best possible ground consists of as many wires as possible, each at least a quarter wave long, buried just below the surface of the earth, and extending out from a common point in the form of radials. Copper wire of any size larger than no. 16 is satisfactory, though the larger sizes will take longer to disintegrate. In fact, the radials need not even be buried; they may be supported just above the earth, and insulated from it. This arrangement is called a counterpoise, and operates by virtue of its high capacitance to ground.

Unless a large number of radials is used, fairly close to the ground, the counterpoise will act more like the bottom half of a half-wave Hertz than like a ground system. However, the efficiency with a counterpoise will be quite good, regardless. It is when the radials are buried, or laid on the ground, that a large number should be used for best efficiency. Broadcast stations use as many as 120 radials of from 0.3 to 0.5 wavelength long.

A large number of radials not only provides a low resistance earth connection, but also, if long enough, produces the effect of locating the radiator over highly conducting earth. The importance of the latter with regard to vertical antennas is illustrated in Figure 4 of Chapter 12.

When it is impossible to extend buried radials in all directions from the ground connection for an inverted-L type Marconi, it is of importance that a few wires be buried directly below the flat top, and spaced at least 10 feet from one another.

If the antenna is physically shorter than a quarter wavelength, the antenna current is higher, due to lower radiation resistance. Consequently, the power lost in resistive soil is greater. The importance of a good ground with short, inductive-loaded Marconi radiators is, therefore, quite obvious. With a good ground system, even very short (one-eighth wavelength) antennas can be expected to give a high percentage of the efficiency of a quarter-wave antenna used with the same ground system. This is especially true when the short radiator is *top loaded* with a high Q (low loss) coil.

Water-Pipe Grounds Water pipe, because of its comparatively large surface and cross section, has a relatively low r-f resistance. If it is possible to attach to a junction of several water pipes (where they branch in several directions and run for some distance under ground), a satisfactory ground connection will be obtained. If one of the pipes attaches to a lawn or garden sprinkler system in the immediate vicinity of the antenna and runs hither and thither to several neighboring faucets within a radius of a hundred yards, the effectiveness of the system will approach that of buried copper radials.

The main objection to water-pipe grounds is the possibility of high resistance joints in the pipe, due to the "dope" put on the coupling threads. By attaching the ground wire to a junction with three or more legs, the possibility of requiring the main portion of the r-f current to flow through a high resistance connection is greatly reduced.

The presence of water in the pipe adds but little to the conductivity; therefore it does not relieve the problem of high resistance joints. Bonding the joints is the best insurance, but this is, of course, impracticable where the pipe is buried. Bonding together with copper wire the various water faucets above the surface of the ground will improve the effectiveness of a water pipe ground system hampered by high-resistance pipe couplings.

Marconi Dimensions A Marconi antenna is an odd number of electrical quarter waves long (usually only one quarter wave in length), and is always resonated to the operating frequency. The correct loading of the final amplifier is accomplished by varying the coupling, *rather than by detuning the antenna from resonance.*

Physically, a quarter-wave Marconi may be made anything from one-eighth to three-eighths wavelength overall, meaning the total length of the antenna wire and ground lead from the end of the antenna to the point where the ground lead attaches to the junction of the radials or counterpoise wires, or the water pipe enters the ground. The longer the antenna is made physically, the lower will be the current flowing in the ground connection, and the greater will be the overall radiation efficiency. However, when the antenna length exceeds three-eighths wavelength, the antenna becomes difficult to resonate by means of a series capacitor, and it begins to take shape as an end-fed Hertz, requiring a method of feed such as has been discussed in connection with Figure 2B.

A radiator physically shorter than a quarter wavelength can be lengthened electrically by means of a series loading coil, and used as a quarter-wave Marconi. However, if the wire is made shorter than approximately one-eighth wavelength, the radiation resistance will be so low that high efficiency cannot be obtained, even with a very good ground.

27-5 Space-Conserving Antennas

In many cases it is desired to undertake a considerable amount of operation on the 80-meter or 40-meter band, but sufficient space is simply not available for the installation of a half-wave radiator for the desired frequency of operation.

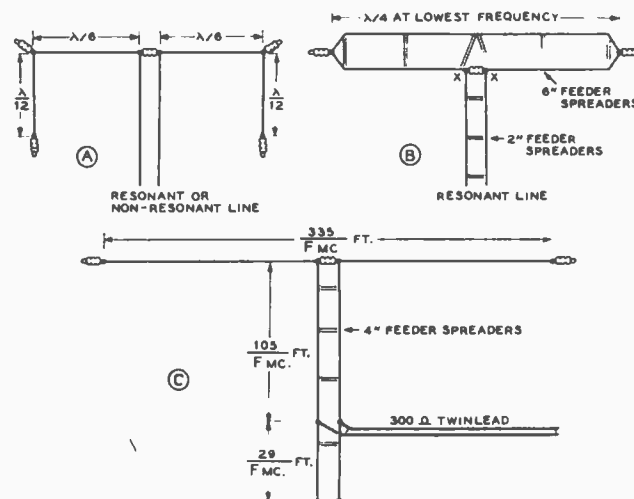

Figure 7.

THREE EFFECTIVE SPACE CONSERVING ANTENNAS.

The arrangements shown at (A) and (B) are satisfactory where resonant feed line can be used. However, non-resonant 75-ohm feed line may be used in the arrangement at (A) when the dimensions in wavelengths are as shown. In the arrangement shown at (B) low standing waves will be obtained on the feed line when the overall length of the antenna is a half wave. The arrangement shown at (C) may be tuned for any reasonable length of flat top to give a minimum of standing waves on the transmission line.

This is a common experience of those who are forced to reside in an apartment house or in a bungalow court. The shortened Marconi antenna operated against a good ground *can* be used under certain conditions, but the shortened Marconi is notorious for the production of broadcast interference, and a good ground connection is usually completely unobtainable in an apartment house.

Essentially, the problem in producing an antenna for low-frequency operation in restricted space is to erect a short radiator which is balanced with respect to ground and which is therefore independent of ground for its operation. Several antenna types meeting this set of conditions are shown in Figure 7. Figure 7A shows a conventional center-fed doublet with bent-down ends. This type of antenna can be fed with 75-ohm twinlead in the center, or it may be fed with a resonant line for operation on several bands. The overall length of the radiating wire will be a few per cent greater than the normal length for such an antenna since the wire is bent at a position intermediate between a current loop and a voltage loop. The actual length will have to be determined by the cut-and-try process due to the increased effect of interfering objects on the effective electrical length of an antenna of this type.

Figure 7B shows a method for using a two-wire doublet on one half of its normal operating frequency. It is recommended that spaced open conductor be used for the radiating portion of the "folded dipole" rather than 300-ohm twinlead as is commonly used when operation on only one frequency is desired. The reason for this recommendation lies in the fact that the two wires of the flat top are *not* at the same potential throughout their length when the antenna is operated on one-half frequency. Twinlead may be used for the feeder line if operation on the frequency where the flat top is one-half wave in length is most common, and operation on one-half frequency is infrequent. However, if the antenna is to be used primarily on one-half frequency as shown it should be fed by means of an open-wire line. If it is desired to feed the antenna with a non-resonant line, a quarter-wave stub may be connected to the antenna at the points X, X in Figure 7B. The stub should be tuned and the transmission line connected to it in the normal manner.

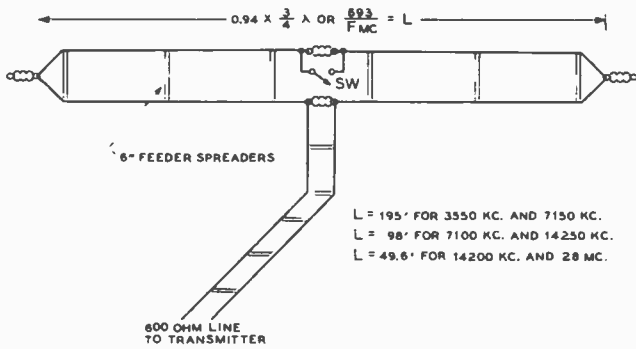

Figure 8.

THE THREE-QUARTER WAVE FOLDED DOUBLET.

This antenna arrangement will give very satisfactory operation with a 600-ohm feed line for operation with the switch open on the fundamental frequency and with the switch closed on twice frequency.

The antenna system shown in Figure 7C may be used when not quite enough length is available for a full half-wave radiator. The dimensions in terms of frequency are given on the drawing. An antenna of this type is 93 feet long for operation on 3600 kc. and 86 feet long for operation on 3900 kc. This type of antenna has the additional advantage that it may be operated on the 7-Mc. and 14-Mc. bands, when the flat top has been cut for the 3.5-Mc. band, simply by changing the position of the shorting bar and the feeder line on the stub. The procedure is discussed in more detail in Section 27-6 of this chapter.

A sacrifice which must be made when using a shortened radiating system, as for example the types shown in Figure 7, is in the bandwidth of the radiating system. The frequency range which may be covered by a shortened antenna system is approximately in proportion to the amount of shortening which has been employed. For example, the antenna system shown in Figure 7C may be operated over the range from 3800 kc. to 4000 kc. without serious standing waves on the feeder line. If the antenna had been made full length it would be possible to cover about half again as much frequency range for the same amount of mismatch on the extremes of the frequency range.

27-6 Multi-Band Antennas

The availability of a multi-band antenna is a great operating convenience to an amateur station. In most cases it will be found best to install an antenna which is optimum for the band which is used for the majority of the available operating time, and then to have an additional multi-band antenna which may be pressed into service for operation on another band when propagation conditions on the most frequently used band are not suitable. Most amateurs use, or plan to install, at least one directive array for one of the higher-frequency bands, but find that an additional antenna which may be used on the 3.5-Mc. and 7.0-Mc. band or even up through the 28-Mc. band is almost indispensable.

The choice of a multi-band antenna depends upon a number of factors such as the amount of space available, the band which is to be used for the majority of operating with the antenna, the radiation efficiency which is desired, and the type of antenna tuning network to be used at the transmitter. A number of recommended types for use under differing conditions are illustrated in Figures 8 through 11.

The 3/4-Wave Folded Doublet Figure 8 shows an antenna type which will be found to be very effective when a moderate amount of space is available, when most of the operating will be done on one band with occasional

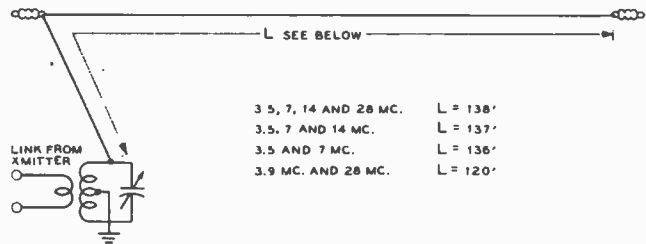

3.5, 7, 14 AND 28 MC.	L = 138'
3.5, 7 AND 14 MC.	L = 137'
3.5 AND 7 MC.	L = 136'
3.9 MC. AND 28 MC.	L = 120'

Figure 9. RECOMMENDED LENGTHS AND METHOD OF FEED FOR THE END-FED HERTZ ANTENNA.

operation on the second harmonic. The system is quite satisfactory for use with high-power transmitters since a 600-ohm non-resonant line is used from the antenna to the transmitter and since the antenna system is balanced with respect to ground. With operation on the fundamental frequency of the antenna where the flat top is 3/4 wave long the switch SW is left open. The system affords a very close match between the 600-ohm line and the feed point of the antenna. Kraus has reported a standing-wave ratio of approximately 1.2 to 1 over the 14-Mc. band when the antenna was located approximately one-half wave above ground (*Radio*, June 1939).

For operation on the second harmonic the switch SW is closed. The antenna is still an effective radiator on the second harmonic but the pattern of radiation will be different from that on the fundamental and the standing-wave ratio on the feed line will be greater.

The End-Fed Hertz The end-fed Hertz antenna shown in Figure 9 is not as effective a radiating system as many other antenna types, but it is particularly convenient when it is desired to install an antenna in a hurry for a test, or for field-day work. The flat top of the radiator should be as high and in the clear as possible. In any event at least three quarters of the total wire length should be in the clear. Dimensions for optimum operation on various amateur bands are given in addition in Figure 9.

The End-Fed Zepp The end-fed Zepp has long been a favorite for multi-band operation. It is shown in Figure 10 along with recommended dimensions for operation on various amateur band groups. Since this antenna type is an unbalanced radiating system, its use is not recommended with high-power transmitters where interference to broadcast listeners is likely to be encountered. The r-f voltages encountered at the end of zepp feeders and at points an electrical half wave from the end are likely to be quite high. Hence the feeders should be supported an adequate distance from surrounding objects and sufficiently in the clear so that a chance encounter between a passerby and the feeder is unlikely.

The coupling coil at the transmitter end of the feeder system can be directly inductively coupled to the transmitter output circuit but the use of a grounded coupling link between the output tank of the transmitter and the feeder-tuning coil is strongly recommended in order to reduce harmonic radiation. Transmitter-to-feed line coupling methods have been discussed in detail in Chapter 10.

The Center-Fed Multi-Band Antenna Several types of center-fed antenna systems are shown in Figure 11. If the feed line is made up in the conventional manner of no. 12 or no. 14 wire spaced 4 to 6 inches the antenna system is sometimes called a center-fed zepp. With this type of feeder the impedance at the transmitter end of the

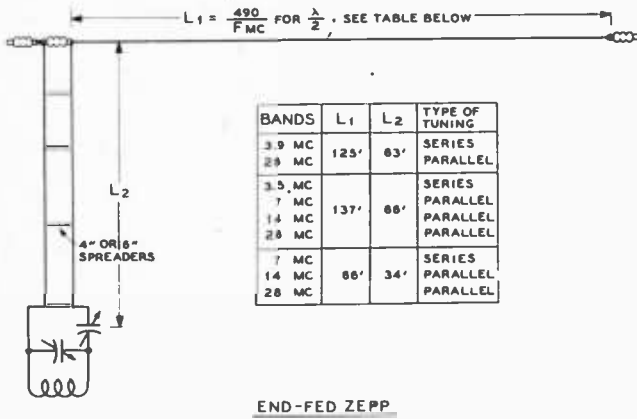

BANDS	L1	L2	TYPE OF TUNING
3.9 MC 29 MC	123'	83'	SERIES PARALLEL
3.5 MC 7 MC 14 MC 28 MC	137'	88'	SERIES PARALLEL PARALLEL PARALLEL
7 MC 14 MC 28 MC	86'	34'	SERIES PARALLEL PARALLEL

END-FED ZEPP

Figure 10.

feeder varies from about 70 ohms to approximately 5000 ohms, the same as is encountered in an end-fed zepp antenna. This great impedance ratio requires provision for either series or parallel tuning of the feeders at the transmitter, and involves quite high r-f voltages at various points along the feed line.

If the feed line between the transmitter and the antenna is made to have a characteristic impedance of approximately 300 ohms the excursions in end-of-feeder impedance are greatly reduced. In fact the impedance then varies from approximately 75 ohms to 1200 ohms. With this much lowered impedance variation it is usually possible to use series tuning on all bands, or merely to couple the antenna directly to the output tank circuit or the harmonic reduction circuit without any separate feeder tuning provision.

There are four practicable types of transmission line which can give an impedance of approximately 300 ohms. The first is, obviously, 300-ohm twinlead. Twinlead of the receiving type *may* be used as a resonant feed line in this case, but its use is not recommended with power levels greater than perhaps 100 watts, and it should not be used when lowest loss in the transmission line is desired. Although twinlead is quite satisfactory for a non-resonant line, it has not been designed for application as a resonant line. The second type is a two-wire air-spaced line with large conductors and close spacing. The ratio of conductor spacing to conductor radius for a characteristic impedance of 300 ohms is 12.22. In other words, no. 10 wire should be spaced 0.6", no. 8 wire should be spaced 0.79", 3/16" copper tubing should be spaced about 1.14", and 1/4-inch copper tubing should be spaced 1.53". Johnson no. 132 2" feeder spreaders have a notch cut in the side for use with 1/4-inch copper tubing at 1 1/2" spacing for making up a 300-ohm line.

The third type of transmission line which may be used to obtain an impedance of 300 ohms is the standard cross-connected four-wire air-spaced line. In this case to obtain, from the equation:

$$Z_0 = 138 \log_{10} \frac{S}{r} - 20.8$$

an impedance of 300 ohms requires a ratio of conductor spacing to conductor radius of 211.2. This high ratio requires the use of rather small wires or rather large spacings. Number 18 wires would be spaced 4" on the sides of the square, or equally about a 5.65" diameter circle.

Probably the most satisfactory method for obtaining a low-loss 300-ohm line of simple construction is to use a four-wire *side-connected* transmission line. This type of transmission line is constructed the same as a conventional cross-connected four-wire line but adjacent pairs of wire are strapped together at

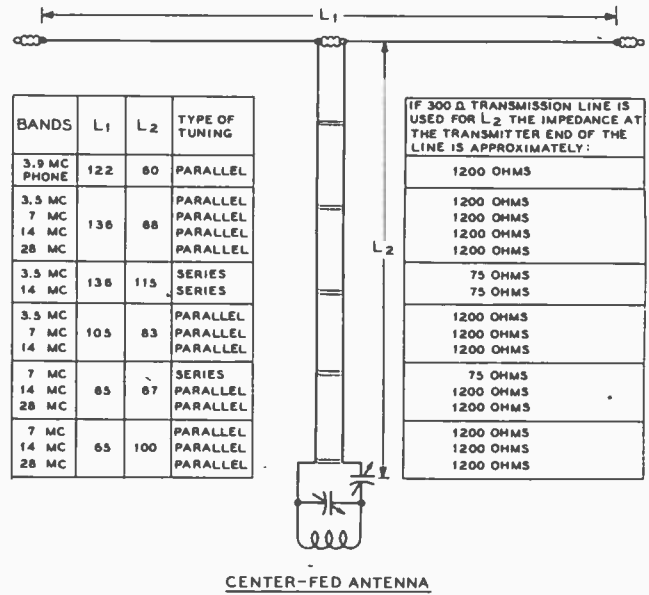

BANDS	L1	L2	TYPE OF TUNING
3.9 MC PHONE	122	80	PARALLEL
3.5 MC 7 MC 14 MC 28 MC	136	88	PARALLEL PARALLEL PARALLEL PARALLEL
3.5 MC 14 MC	136	115	SERIES SERIES
3.5 MC 7 MC 14 MC	105	83	PARALLEL PARALLEL PARALLEL
7 MC 14 MC 28 MC	85	87	SERIES PARALLEL PARALLEL
7 MC 14 MC 28 MC	65	100	PARALLEL PARALLEL PARALLEL

IF 300 Ω TRANSMISSION LINE IS USED FOR L2 THE IMPEDANCE AT THE TRANSMITTER END OF THE LINE IS APPROXIMATELY:

1200 OHMS
1200 OHMS
1200 OHMS
1200 OHMS
75 OHMS
75 OHMS
1200 OHMS
1200 OHMS
1200 OHMS
75 OHMS
1200 OHMS
1200 OHMS
1200 OHMS

CENTER-FED ANTENNA

Figure 11.

the ends (make sure that the same pair is strapped at each end). This type of transmission line has not been very commonly used in the past but it lends itself particularly to the construction of transmission lines with impedances in the range between 260 ohms (above which the four-wire cross-connected line becomes difficult mechanically) and 400 ohms (below which the two-wire line becomes mechanically difficult to construct).

The equation for the characteristic impedance of such a line where the four wires are placed on the corners of a square is:

$$Z_0 = 138 \log_{10} \frac{S}{r} + 20.8$$

where S is the spacing between adjacent wires and r is the radius of the wires. Inspection of the equation shows that the form of the equation is the same as that for the cross-connected four-wire line except that a plus sign has been substituted for the minus sign between the last two terms. This means that if we change the end-strap connections on a four-wire cross-connected line to make it an adjacent-connected line, the impedance of the line will be raised by 41.6 ohms. The actual ratio of spacing to radius for 300 ohms impedance using this type of line is 105.5. It will be noticed that this ratio is exactly half that required for the same value of impedance using a cross-connected line; this fact will be found true in all cases when comparing the two methods of connection for a four-wire line—the ratio of spacings for a cross-connected line is exactly twice that for an adjacent-connected line having the same impedance.

Folded Flat-Top Dual-Band Antenna

As has been mentioned earlier, there is an increasing tendency among amateur operators to utilize rotary or fixed arrays for the 14-Mc. band and those higher in frequency. In order to afford complete coverage of the amateur bands it is then desirable to have an additional system which will operate with equal effectiveness on the 3.5-Mc. and 7-Mc. bands, but this low-frequency antenna system will not be required to operate on any bands higher in frequency than the 7-Mc. band. The antenna system shown in Figure 12 has been developed to fill this need.

The system consists essentially of an open-line folded

dipole for the 7-Mc. band with a special feed system which allows the antenna to be fed with minimum standing waves on the feed line on both the 7-Mc. and 3.5-Mc. bands. The feed-point impedance of a folded dipole on its fundamental frequency is, as has been discussed in Section 27-1, approximately 300 ohms. Hence the 300-ohm twinlead shown in Figure 12 can be connected directly into the center of the system for operation only on the 7-Mc. band and standing waves on the feeder will be very small. However, transmission-line theory teaches us that it is possible to insert an electrical half-wave of transmission line of any characteristic impedance into a feeder system such as this and the impedance at the far end of the line will be exactly the same value of impedance which the half-wave line sees at its termination. Hence this has been done in the antenna system shown in Figure 12; an electrical half wave of line has been inserted between the feed point of the antenna and the 300-ohm transmission line to the transmitter. The characteristic impedance of this additional half-wave section of transmission line has been made about 715 ohms, but since it is an electrical half wave long at 7 Mc. and operates into a load of 300 ohms at the antenna the 300-ohm twinlead at the bottom of the half-wave section still sees an impedance of 300 ohms. The additional half-wave section of transmission line introduces a negligible amount of loss since the current flowing in the section of line is the same which would flow in a 300-ohm line at each end of the half-wave section, and at all other points it is *less* than the current which would flow in a 300-ohm line since the effective impedance is *greater* than 300 ohms in the center of the half-wave section. This means that the loss is less than it would be in an equivalent length of 300-ohm twinlead since this type of manufactured transmission line is made up of conductors which are equivalent to no. 20 wire.

So we see that the added section of 715-ohm line has substantially no effect on the operation of the antenna system on the 7-Mc. band. However, when the flat top of the antenna is operated on the 3.5-Mc. band the feed-point impedance of the flat top is approximately 2600 ohms. Since the section of 715-ohm transmission line is an electrical *quarter-wave* in length on the 3.5-Mc. band, this section of line will have the effect of transforming the approximately 2600 ohms feed-point impedance of the antenna down to an impedance of 200 ohms which will approximately match the 300-ohm impedance of the twinlead transmission line from the transmitter to the antenna system.

The antenna system of Figure 12 operates with very low standing waves over the entire 7-Mc. band, and it will operate with low standing waves from 3500 to 3800 kc. in the 3.5-Mc. band and with sufficiently low standing-wave ratio so that it is quite usable over the entire 3.5-Mc. band.

This antenna system, as well as all other types of multi-band antenna systems, must be used in conjunction with some type of harmonic-reducing antenna tuning network even though the system does present the convenient impedance value of 300 ohms on both bands. Harmonic-reducing antenna-coupling networks have been discussed in detail in Chapter 10, Section 10-4.

27-7 Antenna Construction

The foregoing portion of this chapter has been concerned primarily with the *electrical* characteristics and considerations of antennas. The actual construction of these antennas is just as important. Some of the physical aspects and mechanical problems incident to the actual erection of antennas and arrays will, therefore, be discussed.

Up to 60 feet, there is little point in using mast-type antenna supports unless guy wires must either be eliminated or kept to a minimum. While a little harder to erect, because of their floppy nature, fabricated wood poles of the type to be described

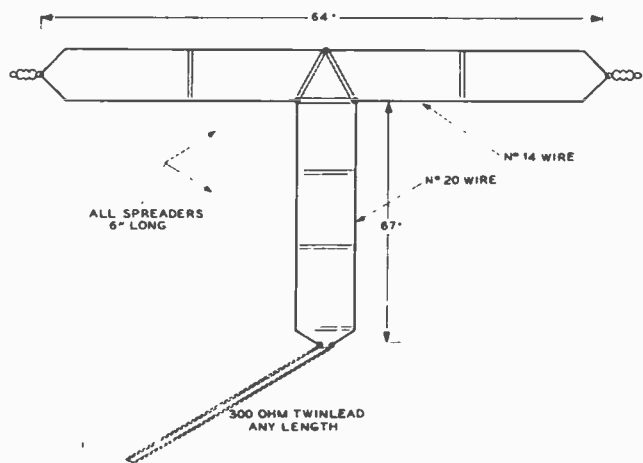

Figure 12.
FOLDED-TOP DUAL-BAND ANTENNA.

This excellent space-conserving two-band antenna is described in detail in the accompanying text.

will be just as satisfactory as more rigid types, *provided* many guy wires are used.

Rather expensive when purchased through the regular channels, 40- and 50-foot telephone poles *sometimes* can be obtained quite reasonably. In the latter case, they are hard to beat, inasmuch as they require no guying if set in the ground six feet (standard depth), and the resultant pull in any lateral direction is not in excess of a hundred pounds or so.

For heights of 80 to 100 feet, either three-sided or four-sided lattice type masts are most practicable. They *can* be made self-supporting, but a few guys will enable one to use a smaller cross section without danger from high winds. The torque exerted on the base of a high self-supporting mast is terrific during a strong wind.

The "A-Frame" Mast

Figures 13A and 13B show the standard method of construction of the "A-frame" type of mast. This type of mast is quite frequently used since there is only a moderate amount of work involved in the construction of the assembly and since the materials cost is relatively small. The three pieces of selected 2 by 2 are first set up on three sawhorses or boxes and the holes drilled for the three $\frac{1}{4}$ -inch bolts through the center of the assembly. Then the base legs are spread out to about 6 feet and the bottom braces installed. Then the upper braces and the cross pieces are installed and the assembly given several coats of good-quality paint as a protection against weathering.

Figure 13C shows another common type of mast which is made up of sections of 2 by 4 placed end-to-end with stiffening sections of 1 by 6 bolted to the edge of the 2 by 4 sections. Both types of masts will require a set of top guys and another set of guys about one-third of the way down from the top. Two guys spaced about 90 to 100 degrees and pulling against the load of the antenna will normally be adequate for the top guys. Three guys are usually used at the lower level, with one directly behind the load of the antenna and two more spaced 120 degrees from the rear guy.

The raising of a mast is made much easier if a "gin pole" about 20 feet high is installed about 30 or 40 feet to the rear of the direction in which the antenna is to be raised. A line from a pulley on the top of the gin pole is then run to the top of the pole to be raised. The gin pole comes into play when the center of the mast has been raised 10 to 20 feet above the ground and an additional elevated pull is required to keep the top of the mast coming up as the center is raised further above ground.

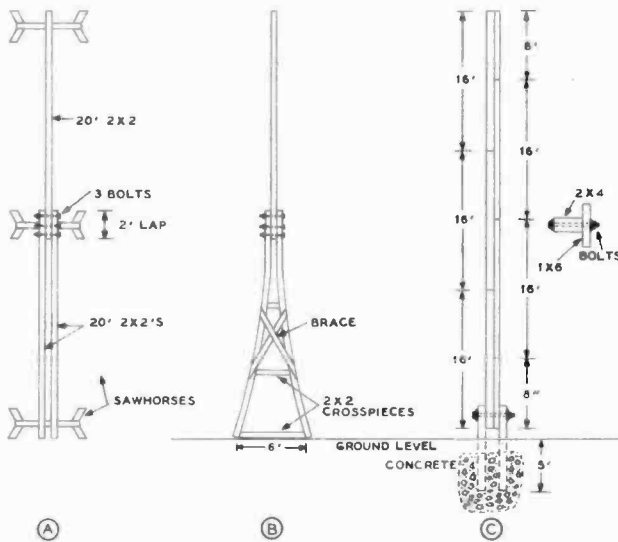

Figure 13.

TWO SIMPLE ANTENNA MASTS.

(A) shows the method of assembly, and (B) shows the completed structure of the A-frame type of antenna. (C) shows a type of structure which is more stable and somewhat more satisfactory for lengths of 50 to 70 feet.

Guy Wires Guy wires should never be pulled taut; a *small* amount of slack is desirable. Galvanized wire, somewhat heavier than seems sufficient for the job, should be used. The heavier wire is a little harder to handle, but costs only a little more and takes longer to rust through. Care should be taken to make sure that no kinks exist when the pole or tower is ready for erection, as the wire will be greatly weakened at such points if a kink is pulled tight, even if it is later straightened.

If "dead men" are used for the guy wire terminations, the wire or rod reaching from the dead men to the surface should be of non-rusting material, such as brass, or given a heavy coating of asphalt or other protective substance to prevent destructive action by the damp soil. Galvanized iron wire will last only a short time when buried in moist soil.

Only strain-type (compression) insulators should be used for guy wires. Regular ones might be sufficiently strong for the job, but it is not worth taking chances, and egg-type strain halyard insulators are no more expensive.

Only a brass or bronze pulley should be used for the halyard, as a nice high pole with a rusted pulley is truly a sad affair. The bearing of the pulley should be given a few drops of heavy machine oil before the pole or tower is raised. The halyard itself should be of good material, preferably waterproofed. Hemp rope of good quality is better than window sash cord from several standpoints, and is less expensive. Soaking it thoroughly in engine oil of medium viscosity, and then wiping it off with a rag, will not only extend its life but minimize shrinkage in wet weather. Because of the difficulty in replacing a broken halyard it is a good idea to replace it periodically, without waiting for it to show excessive wear or deterioration.

It is an excellent idea to tie both ends of the halyard line together in the manner of a flag-pole line. Then the antenna is tied onto the place where the two ends of the halyard are joined. This procedure of making the halyard into a loop prevents losing the "up" end of the halyard should the antenna break near the end, and it also prevents losing the halyard completely should the end of the halyard carelessly be allowed to go free and be pulled through the pulley at the top of the mast by the antenna load. A somewhat longer piece of line is

required but the insurance is well worth the cost of the additional length of rope.

Trees as Supports Often a tall tree can be called upon to support one end of an antenna, but one should not attempt to attach anything to the top, as the swaying of the top of the tree during a heavy wind will complicate matters.

If a tree is utilized for support, provision should be made for keeping the antenna taut without submitting it to the possibility of being severed during a heavy wind. This can be done by the simple expedient of using a pulley and halyard, with weights attached to the lower end of the halyard to keep the antenna taut. Only enough weight to avoid excessive sag in the antenna should be tied to the halyard, as the continual swaying of the tree submits the pulley and halyard to considerable wear.

Galvanized iron pipe, or steel-tube conduit, is often used as a vertical radiator, and is quite satisfactory for the purpose. However, when used for supporting antennas, it should be remembered that the grounded supporting poles will distort the field pattern unless spaced some distance from the radiating portion of the antenna.

Painting The life of a wood mast or pole can be increased several hundred per cent by protecting it from the elements with a coat or two of paint. And, of course, the appearance is greatly enhanced. The wood should first be given a primer coat of flat white outside house paint, which can be thinned down a bit to advantage with second-grade linseed oil. For the second coat, which should not be applied until the first is thoroughly dry, *aluminum paint* is not only the best from a preservative standpoint, but looks very well. This type of paint, when purchased in quantities, is considerably cheaper than might be gathered from the price asked for quarter-pint cans.

Portions of posts or poles below the surface of the soil can be protected from termites and moisture by painting with creosote. While not so strong initially, redwood will deteriorate much more slowly when buried than will the white woods, such as pine.

Antenna Wire The antenna or array itself presents no especial problem. A few considerations should be borne in mind, however. For instance, soft-drawn copper should not be used, as even a short span will stretch several per cent after whipping around in the wind a few weeks, thus affecting the resonant frequency. Enameled-copper wire, as ordinarily available at radio stores, is usually soft drawn, but by tying one end to some object such as a telephone pole and the other to the frame of an auto, a few husky tugs can be given and the wire, after stretching a bit, is equivalent to hard drawn.

Where a long span of wire is required, or where heavy insulators in the center of the span result in considerable tension, copper-clad steel wire is somewhat better than hard-drawn copper. It is a bit more expensive, though the cost is far from prohibitive. The use of such wire, in conjunction with strain insulators, is advisable, where the antenna would endanger persons or property should it break.

For transmission lines and tuning stubs steel-core or hard-drawn wire will prove awkward to handle, and soft-drawn copper should, therefore, be used. If the line is long, the strain can be eased by supporting it at several points.

The use of copper tubing for antennas (except at v.h.f.) is not only expensive but unjustifiable. Though it was a fad at one time, there is no excuse for using anything larger than no. 10 copper or copper-clad wire for any power up to 1 kilowatt. In fact, no. 12 will do the trick just as well, and passes the underwriter's rules if copper-clad steel is used. For powers

of less than 100 watts, the underwriter's rules permit no. 14 wire of solid copper. This size is practically as efficient as larger wire, but will not stand the pull that no. 12 or no. 10 will, and the underwriter's rules call for the latter for powers in excess of 100 watts, if solid copper conductor is used.

More important from an electrical standpoint than the actual size of wire used is the soldering of joints, especially at current loops in an antenna of low radiation resistance. In fact, it is good practice to solder *all* joints, thus insuring quiet operation when the antenna is used for receiving.

Insulation A question that often arises is that of insulation.

It depends, of course, upon the r-f voltage at the point at which the insulator is placed. The r-f voltage, in turn, depends upon the distance from a current node, and the radiation resistance of the antenna. Radiators having low radiation resistance have very high voltage at the voltage loops; consequently, better than usual insulation is advisable at those points.

Open-wire lines operated as nonresonant lines have little voltage across them; hence the most inexpensive ceramic types are sufficiently good electrically. With tuned lines, the voltage depends upon the amplitude of the standing waves. If they are very great, the voltage will reach high values at the voltage loops, and the best spacers available are none too good. At the current loops the voltage is quite low, and almost anything will suffice.

When insulators are subject to very high r-f voltages, they should be cleaned occasionally if in the vicinity of sea water or smoke. Salt scum and soot are not readily dislodged by rain, and when the coating becomes heavy enough, the efficiency of the insulators is greatly impaired.

If a very pretentious installation is to be made, it is wise to check up on both underwriter's rules and local ordinances which might be applicable. If you live anywhere near an airport, and are contemplating a tall pole, it is best to investigate possible regulations and ordinances pertaining to towers in the district, before starting construction.

27-8 Dummy Antennas

In order to test a radio transmitter it is necessary that the full power output of the transmitter be delivered to some type of dissipative load. The radio law states that it is not permissible to test transmitter operation with the antenna connected except for very brief periods. This means therefore that for any type of extensive testing some sort of a dummy antenna must be provided.

The cheapest form of dummy antenna will consist of a 115-volt lamp or a group of 115-volt lamps coupled to the plate tank circuit of the transmitter by means of a four to eight turn pickup coil. In many cases increased coupling from the transmitter to the dummy load will be obtained if a variable capacitor is connected in series with the link coil and the dummy load. The variable capacitor serves to tune out the reactance introduced by the inductance of the pickup loop.

If a lamp or lamps are chosen of such value that they light up approximately to normal brilliance at normal transmitter input, the output may be determined with satisfactory accuracy

by comparing the brilliance of the lamps with similar lamps connected to the 115-volt line. It is difficult to obtain a highly accurate measurement of the output by measuring the r-f current through the lamps and applying Ohm's Law because the resistance of the filament within the lamp cannot be determined accurately. The resistance of a light bulb varies considerably with the amount of current passing through it and with the frequency of the current.

It will be found best when testing a high-power transmitter to use a number of medium wattage lamps (100 to 200 watts) in series parallel rather than coupling the entire output of the transmitter to a single high wattage lamp. If the full energy output of the transmitter is coupled into a single lamp at frequencies in the amateur range, it is quite likely that dielectric breakdown within the stem of the lamp will be the result.

Another type of dummy load that may be used with transmitters having power output from 500 watts to many kilowatts is simply a tank of water. To control the rate of temperature rise in the water the tank (which may be constructed of water-proofed plywood with the seams sealed with tar) should contain approximately five gallons of water for each kilowatt to be dissipated. Pieces of no. 10 copper wire are inserted into the water several inches and spaced as far as it is possible to space them within the dimensions of the tank. Such a load presents a fairly low capacitive reactance in addition to its resistive component. The capacitive reactance may be tuned out with the antenna coupling network of the transmitter. The resistive component of the impedance may be varied from perhaps 100 to 600 ohms by varying the spacing and the depth of insertion of the wire electrodes.

For relatively accurate measurements of the r-f output of the transmitter dummy antenna resistors having a resistance that is substantially constant with varying dissipation are offered by Ohmite in 100-watt and 250-watt ratings. These resistors are available in various resistances between 73 and 600 ohms and can be considered purely resistive and substantially constant in value at frequencies below 15 Mc. It will be noted that the stock resistance values of the dummy antenna loads correspond to the surge impedances of the most common transmission lines.

The dummy-load resistors are hermetically sealed in glass bulb containers, the bulb containing a gas which accelerates the conduction of heat from the resistor element (filament) to the outer surface of the bulb. These resistors glow dull red at full dissipation rating. They may be used in series, parallel or series parallel to obtain other resistance values or greater dissipation.

A correction chart is furnished with the dummy loads so that one may correct for a slight non-linearity in the resistors when a high degree of accuracy is required. With an r-f ammeter of suitable range in series with the resistor load it is necessary only to note the reading and to refer to the chart to determine the exact power being dissipated in the resistance.

The Sprague Mfg. Company also makes available small non-inductive resistors in their Koolohm series which are suitable for making power measurements on medium-power transmitters. This type of non-inductive resistor is available in ratings from 5 watts to 120 watts and in resistance values over a rather complete range.

High-Frequency Directive Antenna Arrays

IT IS becoming of increasing importance in amateur communication to be capable of concentrating the radiated signal from the transmitter in a certain desired direction and to be able to discriminate against reception from directions other than the desired one. Such capabilities involve the use of directive antenna arrays.

Few simple antennas, except the single vertical element, radiate energy equally well in all azimuth (horizontal or compass) directions. All horizontal antennas, except those specifically designed to give an omnidirectional azimuth radiation pattern such as the turnstile, have some directive properties. These properties depend upon the length of the antenna in wavelengths, the height above ground, and the slope of the radiator.

The various forms of the half-wave horizontal antenna produce maximum radiation at right angles to the wire, but the directional effect is not great, excepting for very low vertical angles of radiation (such as would be effective on 10 meters). Nearby objects also minimize the directivity of a dipole radiator, so that it hardly seems worth while to go to the trouble to rotate a simple half-wave dipole in an attempt to improve transmission and reception in any direction.

The half-wave doublet, folded dipole, zepp, single-wire-fed, matched impedance, and Johnson Q antennas all have practically the same radiation pattern *when properly built and adjusted*. They all are dipoles, and the feeder system should have no effect on the radiation pattern.

When a multiplicity of radiating elements is located and phased so as to reinforce the radiation in certain desired directions and to neutralize radiation in other directions, a directive antenna array is formed.

The function of a directive antenna when used for *transmitting* is to give an increase in signal strength in some direction at the expense of radiation in other directions. For *reception*, one might find useful an antenna giving little or no gain in the direction from which it is desired to receive signals

if the antenna is able to *discriminate against interfering signals* and static arriving from other directions. A good directive transmitting antenna, however, generally can also be used to good advantage for reception, as discussed in the previous chapter.

If radiation can be confined to a narrow beam, the signal intensity can be increased a great many times in the desired direction of transmission. This is equivalent to increasing the power output of the transmitter. On the higher frequencies, it is more economical to use a directive antenna than to increase transmitter power, if more than a few watts of power is being used.

Directive antennas for the high-frequency range have been designed and used commercially with gains as high as 23 db over a simple dipole radiator. Gains as high as 35 db are common in direct-ray microwave communication and radar systems. A gain of 23 db represents a power gain of 200 times and a gain of 35 db represents a power gain of almost 3500 times. However, an antenna with a gain of only 15 to 20 db is so sharp in its radiation pattern that it is usable to full advantage only for point-to-point work.

The increase in radiated power in the desired direction is obtained at the expense of radiation in the undesired directions. Power gains of 3 to 12 db seem to be most practicable for amateur communication, since the width of a beam with this order of power gain is wide enough to sweep a fairly large area. Gains of 3 to 12 db represent effective transmitter power increases from 2 to 16 times.

Horizontal Pattern vs. Vertical Angle There is a certain optimum vertical angle of radiation for sky wave communication, this angle being dependent upon distance, frequency, time of day, etc. Energy radiated at an angle much lower than this optimum angle is largely lost, while radiation at angles much higher than this optimum angle oftentimes is not nearly so effective.

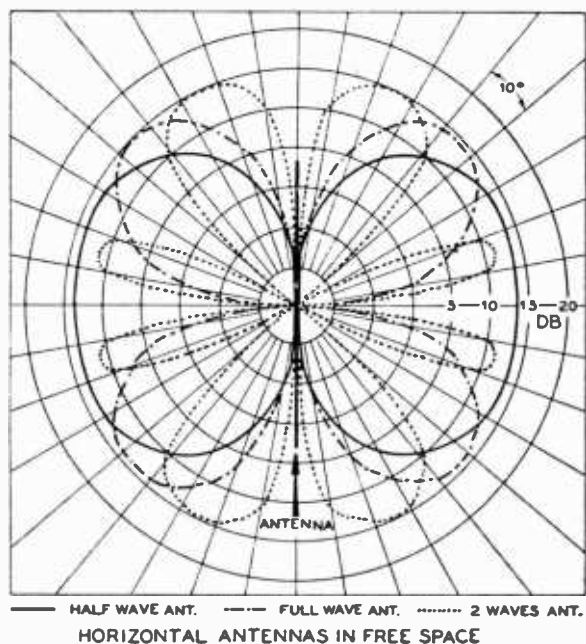

Figure 1.
THEORETICAL FIELD PATTERN IN DB FOR LONG-WIRE ANTENNAS IN FREE SPACE.

The presence of the earth distorts the patterns considerably, making the azimuth pattern a function of the elevation angle.

For this reason, the horizontal directivity pattern as measured on the ground is of no import when dealing with frequencies and distances dependent upon sky wave propagation. It is the horizontal directivity (or gain or discrimination) measured at the most useful vertical angles of radiation that is of consequence. The horizontal radiation pattern, as measured on the ground, is considerably different from the pattern obtained at a vertical angle of 15°, and still more different from a pattern obtained at a vertical angle of 30°. In general, a propagation angle of anything less than 30° above the horizon has proved to be effective for 40- and 80-meter operation over long distances. The energy which is radiated at angles higher than approximately 30° above the earth is not very effective at any frequency for extreme dx.

For operation at frequencies in the vicinity of 14 Mc., the most effective angle of radiation is usually about 15° above the horizon, from any kind of antenna. The most effective angles for 10-meter operation are those in the vicinity of 10°.

The fact that many simple arrays give considerably more gain at 10 and 20 meters than one would expect from consideration of the horizontal directivity, can be explained by the fact that, besides providing some horizontal directivity, they concentrate the radiation at a lower vertical angle. The latter actually may account for the greater portion of the gain obtained by some simple 10-meter arrays. The gain that can be credited to the increased horizontal directivity is never more than 4 or 5 db at most, with the simpler arrays. At 40 and 80 meters, this effect is not so pronounced, most of the gain from an array at these frequencies resulting from the increased horizontal directivity. Thus, a certain type of array may provide 12 to 15 db effective gain over a dipole at 10 meters, and only 3 or 4 db gain at 40 meters.

There is an endless variety of directive arrays that give a substantial power gain in the favored direction. However, some are more effective than others taking up the same space; some are easier to feed, and so forth. To include all the various directive antennas developed in the last decade alone would take more space than can be devoted to the subject here.

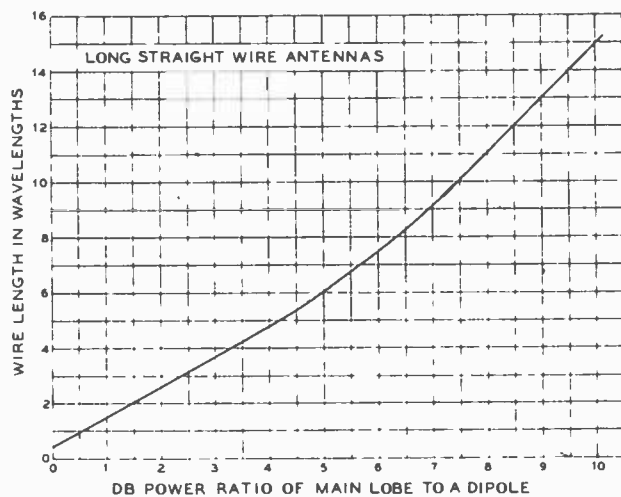

Figure 2.
DIRECTIVE GAIN OF LONG-WIRE ANTENNAS.

28-1 Long Wire Radiators

Harmonically operated antennas radiate better in certain directions than others, but cannot be considered as having appreciable directivity unless several half wavelengths long. The current in adjoining half-wave elements flows in opposite directions at any instant, and thus, the radiation from the various elements adds in certain directions and neutralizes in others.

A half-wave doublet in free space has a "doughnut" of radiation surrounding it. A full wave has 2; 3 half waves 3; and so on. When the radiator is made more than 4 half wavelengths long, the end lobes (cones of radiation) begin to show noticeable power gain over a half-wave doublet, while the broadside lobes get smaller and smaller in amplitude, even though numerous.

The horizontal radiation pattern of such antennas depends upon the vertical angle of radiation being considered. If the wire is more than 4 wavelengths long, the maximum radiation at vertical angles of 15° to 20° (useful for dx) is in line with the wire, being slightly greater a few degrees either side of the wire than directly off the ends. The directivity of the main lobes of radiation is not particularly sharp, and the minor lobes fill in between the main lobes to permit working stations in nearly all directions, though the power radiated broadside to the radiator will not be great if the radiator is more than a few half wavelengths long. The directive gain of long-wire antennas, in terms of the wire length in wavelengths is given in Figure 2.

To maintain the out-of-phase condition in adjoining half-wave elements throughout the length of the radiator, it is necessary that a harmonic antenna be fed either at one end or at a current loop. If fed at a voltage loop, the adjacent sections will be fed in phase, and a different radiation pattern will result.

The directivity of a long wire does not increase very much as the length is increased beyond about 15 wavelengths. This is due to the fact that all long-wire antennas are adversely affected by the r-f resistance of the wire, and because the current amplitude begins to become unequal at different current loops, as a result of attenuation along the wire caused by radiation and losses. As the length is increased, the tuning of the antenna becomes quite broad. In fact, a long wire about 15 waves long is practically aperiodic, and works almost equally well over a wide range of frequencies.

One of the most practical methods of feeding a long-wire antenna is to bring one end of it into the radio room for direct

LONG-ANTENNA DESIGN CHART
Approximate Length in Feet—End-Fed Antennas

Frequency in Mc.	1λ	1 1/2λ	2λ	2 1/2λ	3λ	3 1/2λ	4λ	4 1/2λ
30	32	48	65	81	97	104	130	146
29	33	50	67	84	101	118	135	152
28	34	52	69	87	104	122	140	157
14.4	66 1/2	100	134	169	203	237	271	305
14.2	67 1/2	102	137	171	206	240	275	310
14.0	68 1/2	103 1/2	139	174	209	244	279	314
7.3	136	206	276	346	416	486	555	625
7.15	136 1/2	207	277	347	417	487	557	627
7.0	137	207 1/2	277 1/2	348	418	488	558	628
4.0	240	362	485	618	730	853	977	1100
3.9	246	372	498	625	750	877	1000	1130
3.8	252	381	511	640	770	900	1030	1160
3.7	259	392	525	658	790	923	1060	1190
3.6	266	403	540	676	812	950	1090	1220
3.5	274	414	555	696	835	977	1120	
2.0	480	725	972	1230	1475			
1.9	504	763	1020	1280				
1.8	532	805	1080					

connection to a tuned antenna circuit which is link-coupled to the transmitter. The antenna can be tuned to exact resonance for operation on any harmonic by means of the tuned circuit which is connected to the end of the antenna. This tuned circuit corresponds to an adjustable, non-radiating section of the antenna. A ground is sometimes made to the center of the tuned coil.

If desired, the antenna can be opened and current-fed at a point of maximum current by means of a twisted-pair feeder, twin line, or a quarter-wave matching section and open line.

28-2 The V Antenna

If two long-wire antennas are built in the form of a V, it is possible to make two of the maximum lobes of one leg shoot in the same direction as two of the maximum lobes of the other leg of the V. The resulting antenna is bidirectional (two opposite directions) for the main lobes of radiation. Each side of the V can be made any odd or even multiple of quarter wavelengths, depending on the method of feeding the apex of the V. The complete system must be a multiple of half waves. If each leg is an even number of quarter waves long, the antenna must be voltage-fed at the apex; if an odd number of quarter waves long, current feed must be used.

By choosing the proper apex angle, Figure 3 and Figure 4, the lobes of radiation from the two long-wire antennas aid each other to form a bidirectional beam. Each wire by itself would have a radiation pattern similar to that for antennas operated on harmonics. The reaction of one upon the other removes two of the four main lobes, and increases the other two in such a way as to form two lobes of still greater magnitude.

The correct wire lengths and the degree of the angle θ are listed in the *V-Antenna Design Table* for various frequencies in the 10-, 20- and 40-meter amateur bands. Apex angles for all side lengths are given in Figure 3. The gain of a "V" beam in terms of the side length when optimum apex angle is used is given in Figure 5.

The legs of a very long wire V antenna are usually so arranged that the included angle is twice the angle of the major

lobe from a single wire if used alone. This arrangement concentrates the radiation of each wire along the bisector of the angle, and permits part of the other lobes to cancel each other.

With legs shorter than 3 wavelengths, the best directivity and gain are obtained with a somewhat smaller angle than that determined by the lobes. Optimum directivity for a one-wave V is obtained when the angle is 90° rather than 108°, as determined by the ground pattern alone.

If very long wires are used in the V, the angle between the wires is almost unchanged when the length of the wires in wavelengths is altered. However, an error of a few degrees causes a much larger loss in directivity and gain in the case of the longer V than in the shorter one, which is broader.

The vertical angle at which the wave is best transmitted or received from a horizontal V antenna depends largely upon the included angle. The sides of the V antenna should be at least a half wavelength above ground; commercial practice

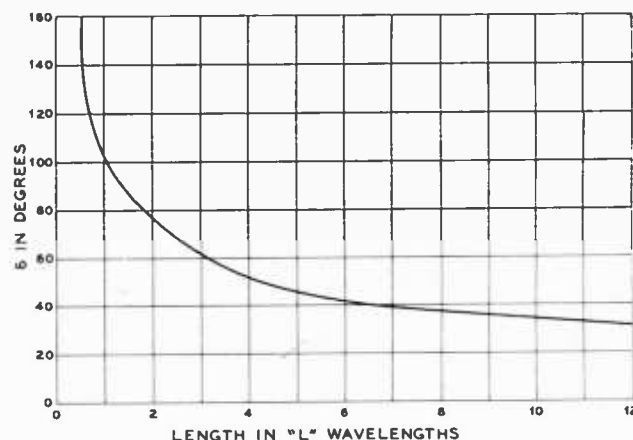

Figure 3.
INCLUDED ANGLE FOR A "V" BEAM.

Showing the included angle between the legs of a V beam antenna for various leg lengths. The included angle may be made somewhat less than that shown by the curve when the legs are relatively short.

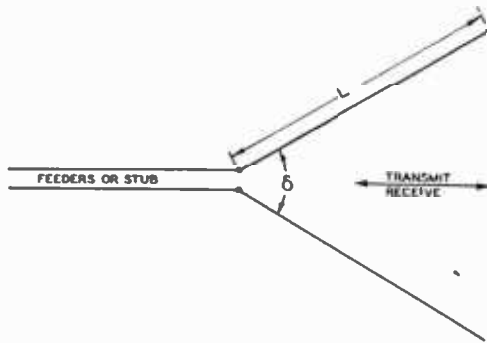

Figure 4.
TYPICAL "V" BEAM ANTENNA.

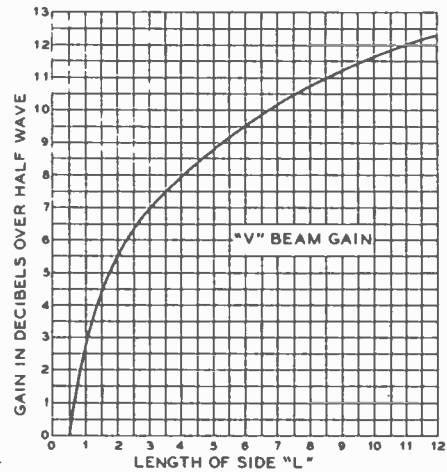

Figure 5.
DIRECTIVE GAIN OF A "V" BEAM.
The curve shows the directive gain of a V beam over a half-wave antenna the same distance above ground in terms of the side length, L.

dictates a height of approximately a full wavelength above ground.

28-3 The Rhombic Antenna

The terminated rhombic or diamond is probably the most effective directional antenna that is practical for amateur communication. This antenna is non-resonant, with the result that it can be used on three amateur bands, such as 10, 20, and 40 meters. When the antenna is non-resonant, i.e., properly terminated, the system is unidirectional, and the wire dimensions are not critical. The rhombic antenna can be suspended over irregular terrain without greatly affecting its practical operation.

When the free end is terminated with a resistance of a value between 700 and 800 ohms the backwave is eliminated, the forward gain is increased, and the antenna can be used on several bands without changes. The terminating resistance should be capable of dissipating one-third the power output of the transmitter, and should have very little reactance. A bank of lamps can be connected in series-parallel for this purpose, or heavy duty carbon rod resistances can be used. For medium or low power transmitters, the non-inductive plaque resistors will serve as a satisfactory termination. Several manufacturers offer special resistors suitable for terminating a rhombic antenna. The terminating device should, for technical reasons, present a small amount of inductive reactance at the point of termination. However, this should not be too great.

A compromise terminating device commonly used consists of a terminated 250-foot or longer length of line, made of resistance wire which does not have too much resistance per unit length. If the latter qualification is not met, the reactance

of the line will be excessive. A 250-foot line consisting of no. 25 nichrome wire, spaced 6 inches and terminated with 800 ohms, will serve satisfactorily. Because of the attenuation of the line, the lumped resistance at the end of the line need dissipate but a few watts even when high power is used. A half-dozen 5000-ohm 2-watt carbon resistors in parallel will serve for all except very high power. The attenuating line may be folded back on itself to take up less room.

The determination of the best value of terminating resistor must be made while transmitting, as the input impedance of the average receiver is considerably lower than 800 ohms. This mismatch will not impair the effectiveness of the array on reception, but as a result, the value of resistor which gives the best directivity on reception will not give the most gain when transmitting. It is preferable to adjust the resistor for maximum gain when transmitting, even though there will be but little difference between the two conditions.

The input resistance of the rhombic which is reflected into the transmission line that feeds it is always somewhat less than the terminating resistance, and is around 700 to 750 ohms when the terminating resistor is 800 ohms.

The antenna should be fed with a non-resonant line having a characteristic impedance of 650 to 700 ohms. The four corners of the rhombic should be at least one-half wavelength above ground for the lowest frequency of operation. For three-

V-ANTENNA DESIGN TABLE				
Frequency in Kilocycles	L = λ δ = 90°	L = 2λ δ = 70°	L = 4λ δ = 52°	L = 8λ δ = 39°
28000	34'8"	69'8"	140'	280'
28500	34'1"	68'6"	137'6"	275'
29000	33'6"	67'3"	135'	271'
29500	33'	66'2"	133'	266'
30000	32'5"	65'	131'	262'
14050	69'	139'	279'	558'
14150	68'6"	138'	277'	555'
14250	68'2"	137'	275'	552'
14350	67'7"	136'	273'	548'
7020	138'2"	278'	558'	1120'
7100	136'8"	275'	552'	1106'
7200	134'10"	271'	545'	1090'
7280	133'4"	268'	538'	1078'

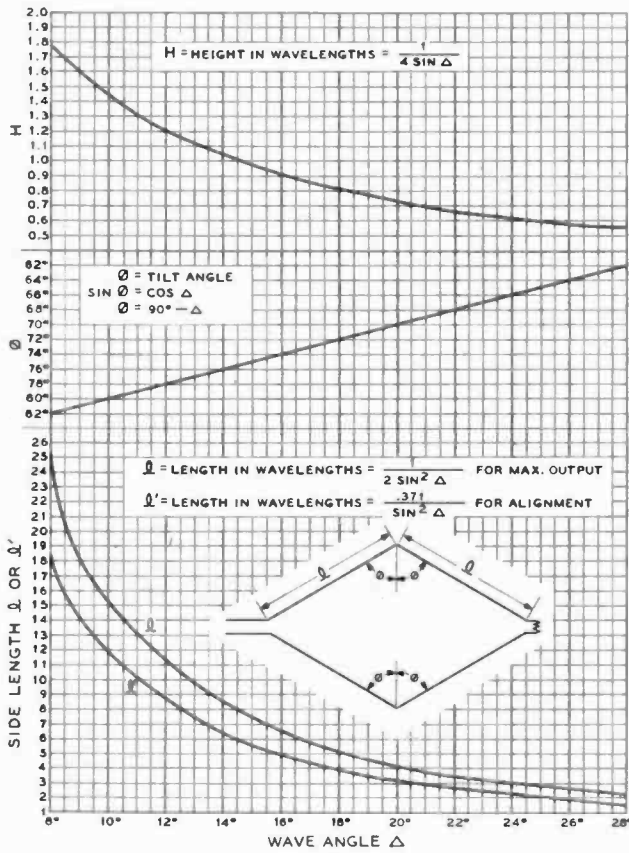

Figure 6.

RHOMBIC ANTENNA DESIGN TABLE.

Design data is given in terms of the wave angle (vertical angle of transmission and reception) of the antenna. The lengths l are for the "maximum output" design; the shorter lengths l' are for the "alignment" method which gives approximately 1.5 db less gain with a considerable reduction in the space required for the antenna. The values of side length, tilt angle, and height for a given wave angle are obtained by drawing a vertical line upward from the desired wave angle.

band operation the proper tilt angle ϕ for the center band should be observed.

The rhombic antenna transmits a horizontally-polarized wave at a relatively low angle above the horizon. The angle of radiation (wave angle) decreases as the height above ground is increased in the same manner as with a dipole antenna. The rhombic should not be tilted in any plane whenever possible. In other words, the poles should all be of the same height and the plane of the antenna should be parallel with the ground.

A considerable amount of directivity is lost when the terminating resistor is left off the end and the system is operated as a resonant antenna. If it is desired to reverse the direction of the antenna it is much better practice to run transmission lines to both ends of the antenna, and then run the terminating line to the operating position. Then with the aid of two d-p-d-t switches it will be possible to connect either feeder to the antenna changeover switch and the other feeder to the terminating line, thus reversing the direction of the array and maintaining the same termination for either direction of operation.

Figure 6 gives curves for optimum-design rhombic antennas by both the maximum-output method and the alignment method. The alignment method is about 1.5 db down from the maximum output method but requires only about 0.74 as much leg length. The height and tilt angle is the same in either case. Figure 7 gives construction data for a recommended

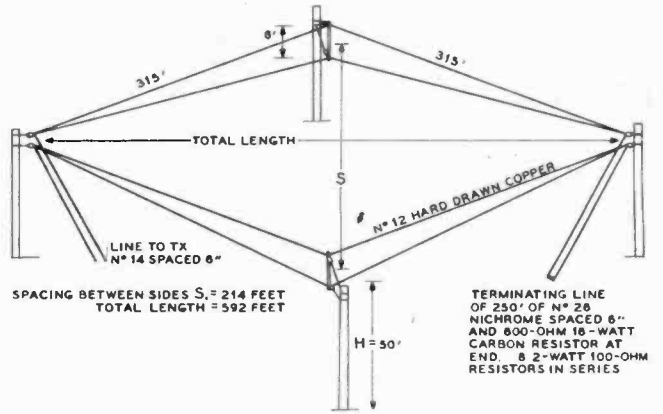

Figure 7.

RECOMMENDED DESIGN FOR A RHOMBIC.

The antenna system illustrated above may be used without change on the 7.0, 14, 21, and 28 Mc. bands. The directivity of the system may be reversed by the method discussed in the text.

rhombic antenna for the 7.0 through 29.7 Mc. bands. This antenna will give about 11 db gain in the 14.0-Mc. band. The approximate gain of a rhombic antenna over a dipole, both above normal soil, is given in Figure 8.

28-4 Stacked-Dipole Arrays

The characteristics of a half-wave dipole already have been described. When another dipole is placed in the vicinity and excited either directly or parasitically, the resultant radiation pattern will depend upon the spacing and phase differential, as well as the relative magnitude of the currents. With spacings less than 0.65 wavelength, the radiation is mainly broadside to the 2 wires (bidirectional) when there is no phase difference, and *through* the wires (end fire) when the wires are 180° out of phase. With phase differences between 0° and 180° (45°, 90°, and 135° for instance), the pattern is unsymmetrical, the radiation being *greater in one direction* than in the opposite direction.

With spacings of more than 0.8 wavelength, more than two main lobes appear for all phasing combinations; hence, such spacings are seldom used.

With the dipoles driven so as to be in phase, the most effective spacing is between 0.5 and 0.7 wavelength. The latter provides greater gain, but minor lobes are present which do not

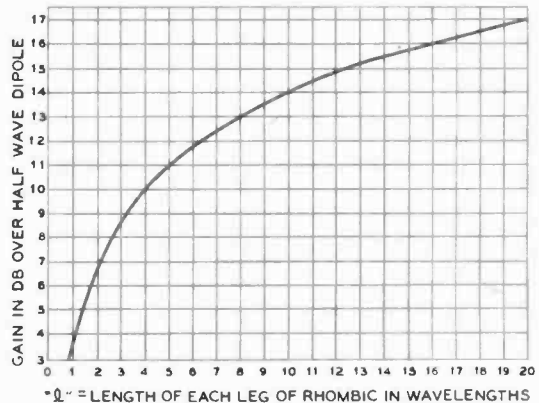

Figure 8.

RHOMBIC ANTENNA GAIN.

Theoretical gain of a rhombic antenna, given in terms of the side length, over a half-wave dipole mounted the same distance above the same type of soil.

appear at 0.5-wavelength spacing. The radiation is broadside to the plane of the wires, and the gain is slightly greater than can be obtained from two dipoles out of phase. The gain falls off rapidly for spacings less than 0.375 wavelength, and there is little point in using spacing of 0.25 wavelength or less with in-phase dipoles, except where it is desirable to increase the radiation resistance. (See *Multi-Wire Doublet*.)

When the dipoles are fed 180° out of phase, the directivity is through the plane of the wires, and is greatest with close spacing, though there is but little difference in the pattern after the spacing is made less than 0.125 wavelength. The radiation resistance becomes so low for spacings of less than 0.1 wavelength that such spacings are not practicable.

In the three foregoing examples, most of the directivity provided is in a plane at a right angle to the 2 wires, though when out of phase, the directivity is in a line through the wires, and when in phase, the directivity is broadside to them. Thus, if the wires are oriented vertically, mostly horizontal directivity will be provided. If the wires are oriented horizontally, most of the directivity obtained will be vertical directivity.

To increase the sharpness of the directivity in all planes that include one of the wires, additional identical elements are added in the line of the wires, and fed so as to be in phase. The familiar H array is one array utilizing both types of directivity in the manner prescribed. The 2-section Kraus flat-top beam is another.

These two antennas in their various forms are directional in a horizontal plane, in addition to being low angle radiators, and are perhaps the most practicable of the *bidirectional* stacked-dipole arrays for amateur use. More phased elements can be used to provide greater directivity in planes including one of the radiating elements. The H then becomes a Sterba-curtain array.

For unidirectional work the most practicable stacked-dipole arrays for amateur-band use are parasitically-excited systems using relatively close spacing between the reflectors and the directors. Antennas of this type are described in detail in Chapter 30. The next most practicable unidirectional array is an H or a Sterba curtain with a similar system placed approximately one-quarter wave behind. The added array may be directly fed by means of a section of line one-quarter wave in length, or it may be parasitically excited. The use of a reflector in conjunction with any type of stacked-dipole broadside array will increase the gain by 3 db.

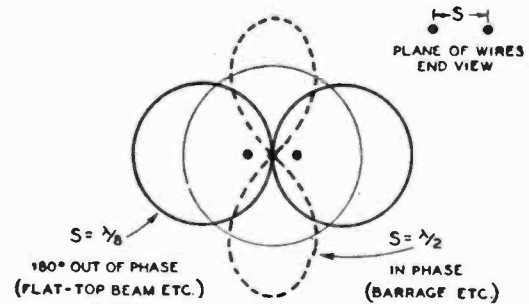

Figure 9.
RADIATION PATTERNS OF A PAIR OF DIPOLES OPERATING IN-PHASE AND 180° OUT OF PHASE.
 If the dipoles are oriented horizontally most of the directivity will be in the vertical plane; if oriented vertically most of the directivity will be in the horizontal plane.

Colinear Arrays The simple colinear antenna array is a very effective radiating system for the 3.5-Mc. and 7.0-Mc. bands, but its use is not recommended on higher frequencies since such arrays do not possess any vertical directivity. The elevation radiation pattern for such an array is essentially the same as for a half-wave dipole. This consideration applies whether the elements are of normal length or are extended.

The colinear antenna consists of two or more radiating sections from 0.5 to 0.65 wavelengths long, with the current in phase in each section. The necessary phase reversal between sections is obtained through the use of resonant tuning stubs as illustrated in Figure 10. The gain of a colinear array using half-wave elements in decibels is approximately equal to the number of elements in the array. The exact figures are as follows:

Number of Elements	2	3	4	5	6
Gain in Decibels	1.8	3.3	4.5	5.3	6.2

As additional in-phase colinear elements are added to a doublet, the radiation resistance goes up much faster than when additional half waves are added out of phase (harmonic operated antenna).

For a colinear array of from 2 to 6 elements, the terminal radiation resistance in ohms at any current loop is approximately 100 times the number of elements.

It should be borne in mind that the *gain* from a colinear antenna depends upon the *sharpness* of the horizontal direc-

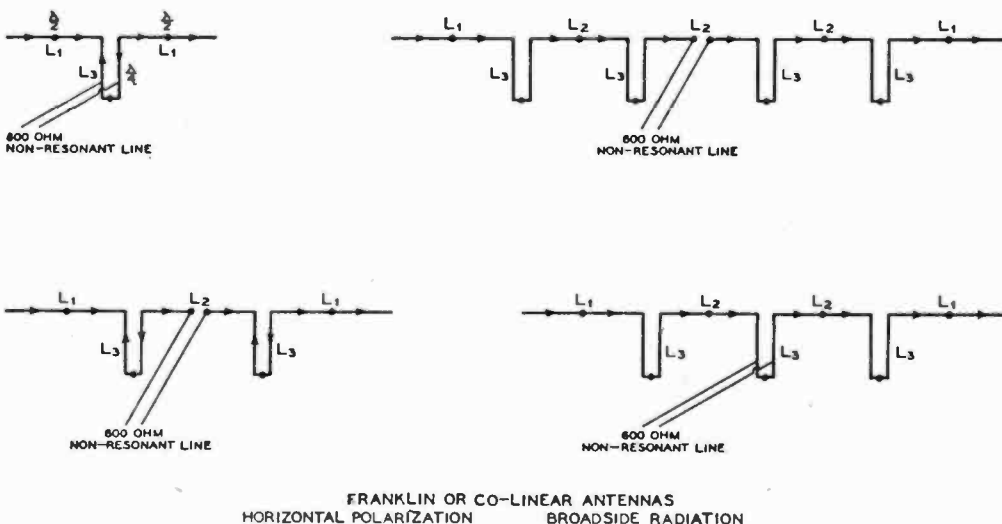

FIGURE 10.

COLINEAR ANTENNA DESIGN CHART			
FREQUENCY IN MC.	L ₁	L ₂	L ₃
14.4	33'4"	34'3"	17'1"
14.2	33'8"	34'7"	17'3"
14.0	34'1"	35'	17'6"
7.3	65'10"	67'6"	33'9"
7.15	67'	68'8"	34'4"
7.0	68'5"	70'2"	35'1"
4.0	120'	123'	61'6"
3.9	123'	126'	63'
3.6	133'	136'5"	68'2"

tivity since no vertical directivity is provided. An array with several colinear elements will give considerable gain, but will cover only a very limited arc.

Double Extended Zepp The gain of a conventional 2-element Franklin colinear antenna can be increased to a value approaching that obtained from a 3-element Franklin, simply by making the 2 radiating elements 230° long instead of 180° long. The phasing stub is shortened correspondingly to maintain the whole array in resonance. Thus, instead of having 0.5-wavelength elements and 0.25-wavelength stub, the elements are made 0.64 wavelength long and the stub approximately 0.18 wavelength long.

The correct radiator dimensions for a 230° double zepp can be obtained from the *Colinear Antenna Design Chart* simply by multiplying the L₁ values by 1.29. The length for L₃ must be determined experimentally for best results. It will be between 0.15 and 0.2 wavelength.

The vertical directivity of a colinear antenna having 230° elements is the same as for one having 180° elements. There is little advantage in using extended sections when the total length of the array is to be greater than about 1.5 wavelength overall since the gain of a colinear antenna is proportional to the overall length, whether the individual radiating elements are ¼ wave, ½ wave or ¾ wave in length.

28-5 Broadside Arrays

Colinear elements may be stacked above or below another string of colinear elements to produce what is commonly called a *broadside* array. Such an array, when horizontal elements are used, possesses vertical directivity in proportion to the number of broadsided sections which have been used. Since broadside arrays do have good vertical directivity their use is recommended on the 14-Mc. band and on those higher in frequency. One of the most popular of simple broadside arrays is the "Lazy H" array of Figure 11. Horizontal colinear elements stacked two above two make up this antenna system which is highly recommended for amateur work on 10 and 20 meters when substantial gain without too much directivity is desired. It has high radiation resistance and a gain of approximately 5.5 db. The low radiation resistance results in low voltages and a broad resonance curve, which permits use of inexpensive insulators and enables the array to be used over a fairly wide range in frequency. For dimensions, see the stacked dipole design table.

The Sterba Curtain Vertical stacking may be applied to strings of colinear elements longer than 2 half waves. In such arrays, the end quarter wave of each string of radiators usually is bent in to meet a similar bent quarter wave from the opposite end radiator. This provides better balance and better coupling between the upper and lower elements when the array is current-fed. Arrays of this type are shown in Figure 12, and are commonly known as Sterba curtains.

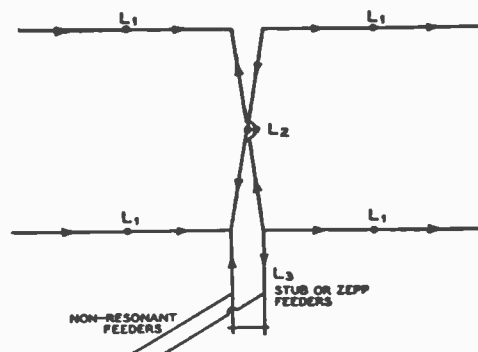

Figure 11.

THE POPULAR "LAZY H" ARRAY.

Stacking the colinear elements gives both horizontal and vertical directivity. As shown the array will give about 5.5 db gain. By adding a reflector made the same as the antenna the system becomes unidirectional and the gain increases to about 9 db.

Correct length for the elements and stubs can be determined for any stacked dipole array from the *Stacked-Dipole Design Table*.

In the sketches of Figure 12 the arrowheads represent the direction of current flow at any given instant. The dots on the radiators represent points of maximum current. All arrows should point in the same direction in each portion of the radiating sections of an antenna in order to provide a field in phase for broadside radiation. This condition is satisfied for the arrays illustrated in Figure 12. Figures 12A and 12D show alternative methods of feeding a short Sterba curtain, while other methods of feed are shown in the other antennas of Figure 12. The array of Figure 12E gives very high gain but requires a height of greater than 1½ wavelengths; hence such an array is usable under ordinary conditions on the 28-Mc. and 50-Mc. bands. In the case of each of the arrays of Figure 12, and also the "Lazy H" of Figure 11, the array may be made unidirectional and the gain increased by 3 db if an exactly similar array is constructed and placed approximately ¼ wave behind the driven array. A screen or mesh of wires slightly greater in area than the antenna array may be used instead of an additional array as a reflector to obtain a unidirectional system. The spacing between the reflecting wires may vary from 0.05 to 0.1 wavelength with the spacing between the reflecting wires the smallest directly behind the driven elements. The wires in the untuned reflecting system should be parallel to the radiating elements of the array, and the spacing of the complete reflector system should be approximately 0.2 to 0.25 wavelength behind the driven elements.

28-6 End-Fire Directivity

By spacing 2 half-wave dipoles, or colinear arrays, at a distance of from 0.1 to 0.25 wavelength and driving the two 180° out of phase, directivity is obtained *through the 2 wires* at right angles to them. Hence, this type of bidirectional array is called *end fire*. A better idea of end-fire directivity can be obtained by referring to Figure 9.

Remember that *end-fire* refers to the radiation with respect to the 2 wires in the array rather than with respect to the array as a whole.

The vertical directivity of an end-fire bidirectional array which is oriented horizontally can be increased by placing a similar end-fire array a half wave below it, and excited in the same phase. Such an array is a combination broadside and end-fire affair. However, most arrays are made either broadside

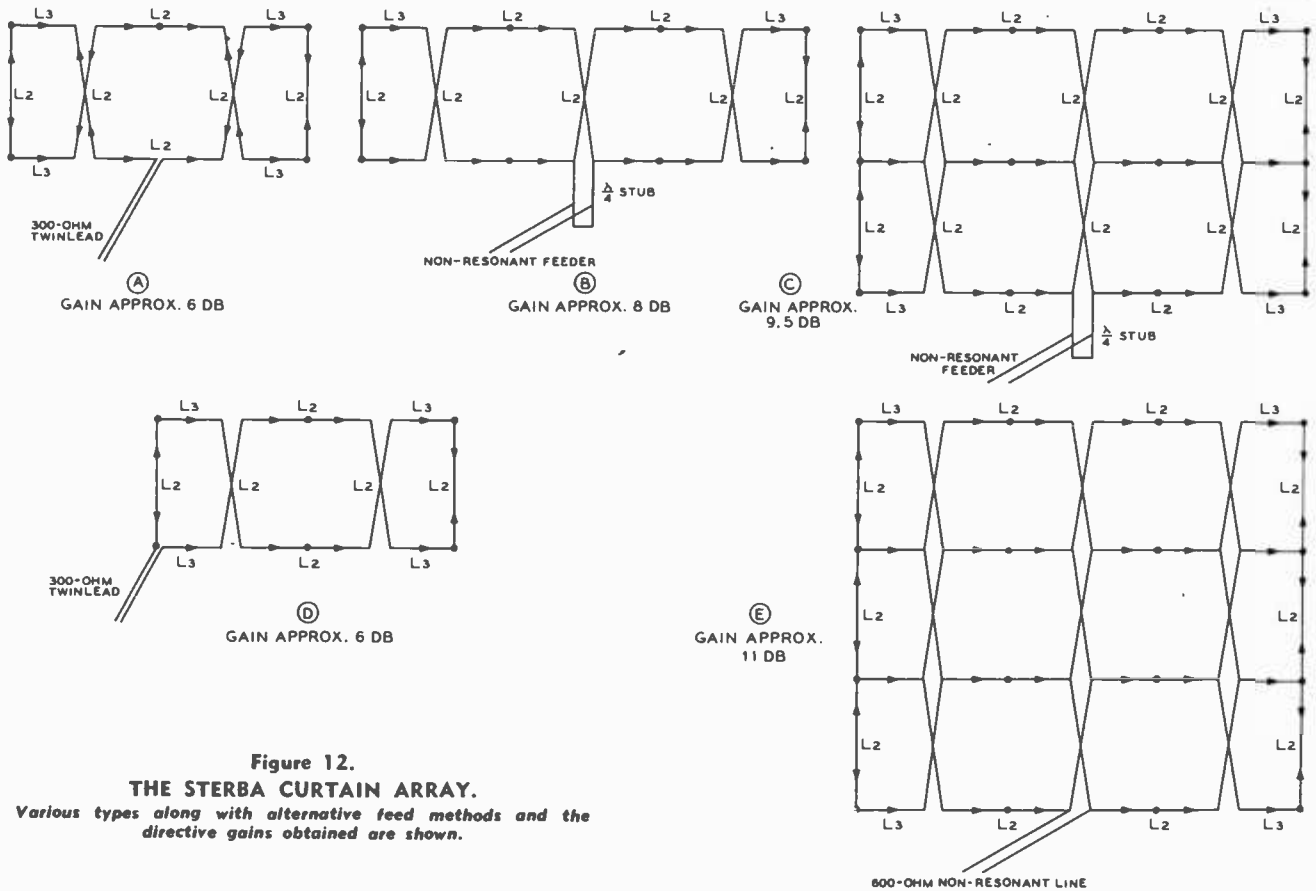

Figure 12.
THE STERBA CURTAIN ARRAY.
Various types along with alternative feed methods and the directive gains obtained are shown.

or end-fire, rather than a combination of both, though the latter are satisfactory if designed properly.

Unidirectional End-Fire Arrays A simple unidirectional end-fire array is illustrated in Figure 13. If such an array is made 2 wavelengths long its gain will be approximately 8.5 db, if it is made 3 wavelengths long its gain will be about 10 db. Such arrays are convenient when it is desired to construct a high-gain array to radiate in a line between two poles. Such an array may be reversed in the same manner as a rhombic antenna by bringing feeders from both ends of the antenna into the control position and running an additional 300-ohm terminating line made up of resistance wire out from this location. The reversing procedure is the same as for the rhombic. End-fire arrays of this type have another characteristic which is similar to the rhombic; they are effective in concentrating radiation both in the elevation

and azimuth planes. Hence such arrays are good low-angle radiators. The amount of energy which must be dissipated by the terminating resistor is relatively large, as in the case of the rhombic, and decreases as the length of the array is increased.

Kraus Flat-Top Beam A very effective bidirectional end-fire array is the Kraus *Flat-Top Beam*. Essentially, this antenna consists of 2 close-spaced di-poles or colinear arrays. Because of the close spacing, it is possible to obtain the proper phase relationships in multi-section flat tops by crossing the wires at the voltage loops, rather than by resorting to phasing stubs. This greatly simplifies the array. (See Figure 14.) Any number of sections may be used, though the 1- and 2-section arrangements are the most popular. Little extra gain is obtained by using more than 4 sections, and trouble from phase shift may appear.

STACKED DIPOLE DESIGN TABLE			
FREQUENCY IN MC.	L ₁	L ₂	L ₃
7.0	68'2"	70'	35'
7.3	65'10"	67'6"	33'9"
14.0	34'1"	35'	17'6"
14.2	33'8"	34'7"	17'3"
14.4	34'4"	34'2"	17'
21.0	22'9"	23'3"	11'8"
21.5	22'3"	22'9"	11'5"
27.3	17'7"	17'10"	8'11"
28.0	17'	17'7"	8'9"
29.0	16'6"	17'	8'6"
50.0	9'7"	9'10"	4'11"
52.0	9'3"	9'5"	4'8"
54.0	8'10"	9'1"	4'6"
144.0	39.8"	40.5"	20.3"
146.0	39"	40"	20"
148.0	38.4"	39.5"	19.8"

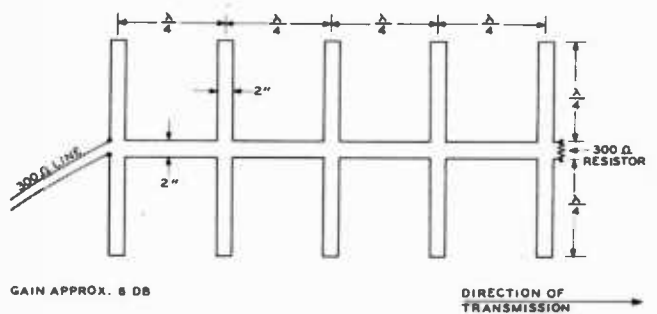

Figure 13.
END-FIRE ARRAY USING FOLDED ELEMENTS

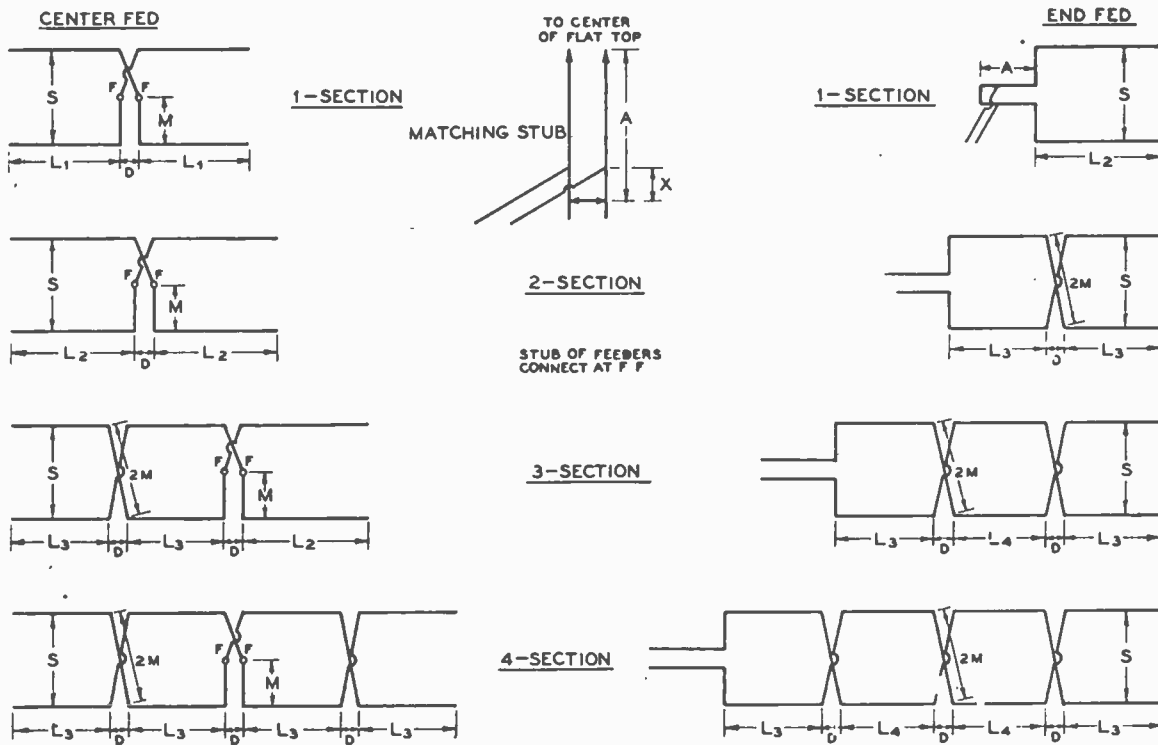

Figure 14.
FLAT-TOP BEAM DESIGN DATA.

Frequency	Spac- ing	S	L ₁	L ₂	L ₃	L ₄	M	D	A(1/4) approx.	A(1/2) approx.	A(3/4) approx.	X approx.
7.0- 7.2 Mc.	$\lambda/8$	17' 4"	34'	60'	52' 8"	44'	8' 10"	4'	26'	60'	96'	4'
7.2- 7.3	$\lambda/8$	17' 0"	33' 6"	59'	51' 8"	43' 1"	8' 8"	4'	26'	59'	94'	4'
14.0-14.4	$\lambda/8$	8' 8"	17'	30'	26' 4"	22'	4' 5"	2'	13'	30'	48'	2'
14.0-14.4	.15 λ	10' 5"	17'	30'	25' 3"	20'	5' 4"	2'	12'	29'	47'	2'
14.0-14.4	.20 λ	13' 11"	17'	30'	22' 10"		7' 2"	2'	10'	27'	45'	3'
14.0-14.4	$\lambda/4$	17' 4"	17'	30'	20' 8"		8' 10"	2'	8'	25'	43'	4'
28.0-29.0	.15 λ	5' 2"	8' 6"	15'	12' 7"	10'	2' 8"	1' 6"	7'	15'	24'	1'
28.0-29.0	$\lambda/4$	8' 8"	8' 6"	15'	10' 4"		4' 5"	1' 6"	5'	13'	22'	2'
29.0-30.0	.15 λ	5' 0"	8' 3"	14' 6"	12' 2"	9' 8"	2' 7"	1' 6"	7'	15'	23'	1'
29.0-30.0	$\lambda/4$	8' 4"	8' 3"	14' 6"	10' 0"		4' 4"	1' 6"	5'	13'	21'	2'

Dimension chart for flat-top beam antennas. The meanings of the symbols are as follows:
 L₁, L₂, L₃ and L₄, the lengths of the sides of the flat-top sections as shown in Figure 14. L₁ is length of the sides of single-section center-fed, L₂ single-section end-fed and 2-section center-fed, L₃ 4-section center-fed and end-sections of 4-section end-fed, and L₄ middle sections of 4-section end-fed.
 S, the spacing between the flat-top wires.
 M, the wire length from the outside to the center of each cross-over.
 D, the spacing lengthwise between sections.
 A (1/4), the approximate length for a quarter-wave stub.
 A (1/2), the approximate length for a half-wave stub.
 A (3/4), the approximate length for a three-quarter wave stub.
 X, the approximate distance above the shorting wire of the stub for the connection of a 600-ohm line. This distance, as given in the table, is approximately correct only for 2-section flat-tops. For single section types it will be smaller and for 3- and 4-section types it will be larger.
 The lengths given for a half-wave stub are applicable only to single-section center-fed flat-tops. To be certain of sufficient stub length, it is advisable to make the stub a foot or so longer than shown in the table, especially with the end-fed types. The lengths, A, are measured from the point where the stub connects to the flat-top.
 Both the center and end-fed types may be used horizontally. However, where a vertical antenna is desired, the flat-tops can be turned on end. In this case, the end-fed types may be more convenient, feeding from the lower end.

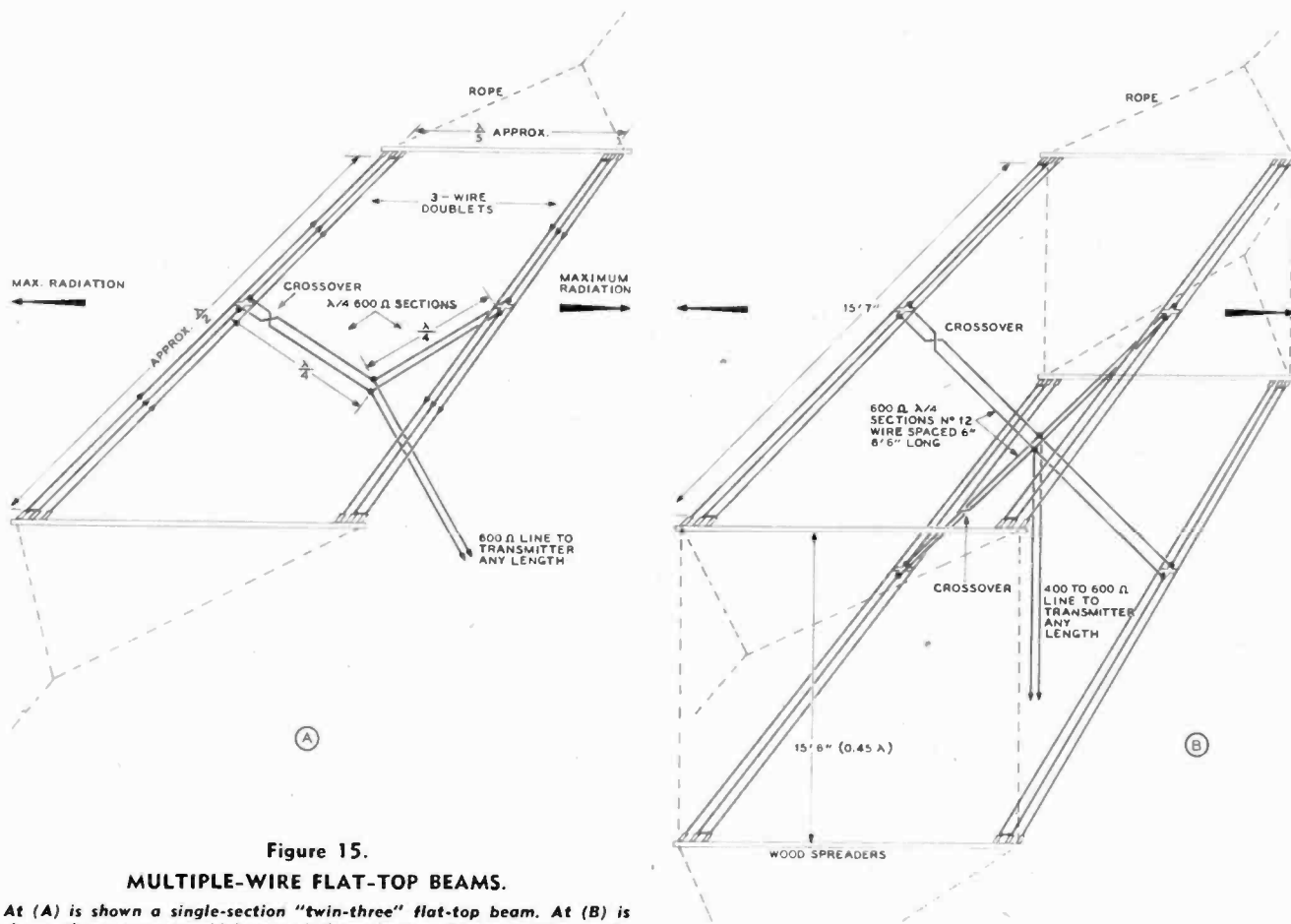

Figure 15.

MULTIPLE-WIRE FLAT-TOP BEAMS.

At (A) is shown a single-section "twin-three" flat-top beam. At (B) is shown the manner in which two of the antennas shown at (A) may be stacked to increase elevation directivity in making up a "double twin-three" antenna array for the 28-Mc. band. Through the use of three-wire radiating elements the feed-point impedance of these driven elements is increased to the point where the arrays may be fed through 600-ohm matching transformers directly from an open-wire line. The gain of the twin-three antenna is approximately 4 db and the addition of the other section to make up the double twin-three antenna increases the gain to approximately 8 db.

A center-fed single-section flat-top beam cut according to the table, can be used quite successfully on its second harmonic, the pattern being similar except that it is a little sharper. The single-section array can also be used on its fourth harmonic with some success, though there then will be four cloverleaf lobes, much the same as with a full-wave antenna.

If a flat-top beam is to be used on more than one band, tuned feeders are necessary.

The radiation resistance of a flat-top beam is rather low, especially when only one section is used. This means that the voltage will be high at the voltage loops. For this reason, especially good insulators should be used for best results in wet weather.

The exact lengths for the radiating elements are not especially critical, because slight deviations from the correct lengths can be compensated for in the stub or tuned feeders. Proper stub adjustment is covered in Chapter 12. Suitable radiator lengths and approximate stub dimensions are given in the accompanying design table.

Figure 14 shows top views of 8 types of flat-top beam antennas. The dimensions for using these antennas on different bands are given in the design table. The 7- and 28-Mc. bands are divided into two parts, but the dimensions for either the low- or high-frequency ends of these bands will be satisfactory for use over the entire band.

In any case, the antennas are tuned to the frequency used, by adjusting the shorting wire on the stub, or tuning the feeders, if no stub is used. The data in the table may be ex-

tended to other bands or frequencies by applying the proper factor. Thus, for 50 to 52 Mc. operation, the values for 28 to 29 Mc. are divided by 1.8.

All of the antennas have a bidirectional horizontal pattern on their fundamental frequency. The maximum signal is broadside to the flat top. The single-section type has this pattern on both its fundamental frequency and second harmonic. The other types have 4 main lobes of radiation on the second and higher harmonics. The nominal gains of the different types over a half-wave comparison antenna are as follows: single-section, 4 db; 2-section, 6 db; 3-section, 7 db; 4-section, 8 db.

The maximum spacings given make the beams less critical in their adjustments. Up to one-quarter wave spacing may be used on the fundamental for the 1-section types and also the 2-section center-fed, but it is not desirable to use more than 0.15 wavelength spacing for the other types.

Although the center-fed type of flat-top generally is to be preferred because of its symmetry, the end-fed type often is convenient or desirable. For example, when a flat-top beam is used vertically, feeding from the lower end is in most cases more convenient.

If a multisection flat-top array is end-fed instead of center-fed, and tuned feeders are used, stations off the ends of the array can be worked by tying the feeders together and working the whole affair, feeders and all, as a long-wire harmonic antenna. A single-pole double-throw switch can be used for changing the feeders and directivity.

V-H-F and U-H-F Antennas

THE *very-high-frequency* or *v-h-f* frequency range is defined as that range falling between 30 and 300 Mc. The *ultra-high-frequency* or *u-h-f* range is defined as falling between 300 and 3000 Mc. Hence this chapter will be devoted to the design and construction of antenna systems for operation on the amateur 50-Mc., 144-Mc., 235-Mc., and 420-Mc. bands. Although the basic principles of antenna operation are the same for all frequencies, the shorter physical length of a wave in this frequency range and the differing modes of signal propagation make it possible and expedient to use antenna systems different in design from those used on the range from 3 to 30 Mc.

29-1 Antenna Requirements

Any type of antenna system usable on the lower frequencies may be used in the v-h-f and u-h-f bands. In fact, simple non-directive half-wave or quarter-wave vertical antennas are very popular for general transmission and reception from all directions, especially for short-range work. But for serious v-h-f or u-h-f work the use of some sort of directional antenna array is a necessity. In the first place, when the transmitter power is concentrated into a narrow beam the *apparent* transmitter power at the receiving station is increased many times. A "billboard" array or a Sterba curtain having a gain of 16 db will make a 25-watt transmitter sound like a kilowatt at the other station. Even a much simpler and smaller three- or four-element parasitic array having a gain of 7 to 10 db will produce a marked improvement in the received signal at the other station.

However, as all v-h-f and u-h-f enthusiasts know, the most important contribution of a high-gain antenna array is in reception. If a remote station cannot be heard it is obviously impossible to make contact. The limiting factor in v-h-f and u-h-f reception is in almost every case the noise generated within the receiver itself. Atmospheric noise is almost non-existent and ignition interference can almost invariably be reduced to a satisfactory level through the use of one of the effective noise limiters described in Chapter 5. Even with a grounded-grid or neutralized triode first stage in the receiver the noise contribution of the first tuned circuit in the receiver

will be relatively large. Hence it is desirable to use an antenna system which will deliver the greatest signal voltage to the first tuned circuit for a given field strength at the receiving location.

Since the field intensity being produced at the receiving location by a remote transmitting station may be assumed to be constant, the receiving antenna which intercepts the greatest amount of wave front, assuming that the polarization and directivity of the receiving antenna is proper, will be the antenna which gives the best received signal-to-noise ratio. Hence an antenna which has two square wavelengths effective area will pick up twice as much signal power as one which has one square wavelength area, assuming the same general type of antenna and that both are directed at the station being received. Many instances have been reported, especially in the case of the 50-Mc. band, where the band sounded completely dead with a simple dipole receiving antenna but when the receiver was switched to a three-element or larger array a considerable amount of activity from 80 to 160 miles distant was heard.

Angle of Radiation The useful portion of the signal in the v-h-f or u-h-f range for short or medium distance communication is that which is radiated at a very low angle above the surface of the earth; essentially it is that signal which is radiated parallel to the surface of the earth. A vertical antenna transmits a *portion* of its radiation at a very low angle and is effective for this reason; its radiation is not necessarily effective simply because it is vertically polarized. A simple horizontal dipole radiates very little low-angle energy and hence is not a satisfactory v-h-f or u-h-f radiator. Directive arrays which concentrate a major portion of the radiated signal at a low radiation angle (such as those described in the previous chapter) will prove to be effective radiators whether their signal is horizontally or vertically polarized.

In any event the radiating system for v-h-f and u-h-f work should be as high and in the clear as possible. Increasing the height of the antenna system will produce a very marked improvement in the number and strength of the signals heard, regardless of the actual type of antenna used.

Transmission Lines Transmission lines to v-h-f and u-h-f antenna systems may be either of the parallel-conductor or coaxial conductor type. Wave guides may be used under certain conditions for frequencies greater than perhaps 1500 Mc. but their dimensions become excessively great for frequencies much below this value. Non-resonant transmission lines will be found to be considerably more efficient on these frequencies than those of the resonant type. In any event it is wise to use the very minimum length of transmission line possible since transmission line losses at frequencies above about 100 Mc. mount very rapidly.

Open lines should preferably be spaced closer than is common for longer wavelengths, as 6 inches is an appreciable fraction of a wavelength at 2 meters. Radiation from the line will be minimized if 1½-inch spacing is used, rather than the more common 6-inch spacing.

Antenna Changeover It is strongly recommended that the same antenna be used for transmitting and receiving in the v-h-f and u-h-f range. An ever-present problem in this connection, however, is the antenna changeover relay. Reflections at the antenna changeover relay become of increasing importance as the frequency of transmission is increased. When coaxial cable is used as the antenna transmission line, satisfactory coaxial antenna changeover relays with low reflection can be used. One type manufactured by Price Brothers, Frederick, Maryland, has proven to be quite satisfactory. When open-wire lines are used, the changeover relay pairs manufactured by Advance Electric & Relay Co., Los Angeles 26, Calif., will give a moderately low value of reflection. An alternative system which will give very low reflection from the changeover system is shown in Figure 1. This arrangement is an adaptation of the "TR" system used in radar work. Figure 1A shows the system used with an open-wire line. When the relays are not energized the short on the line to the transmitter one-quarter wave from the junction point appears as an open circuit at the point of junction so that all the received energy passes to the receiver. The reverse condition takes place when both relays are energized for transmission and all the transmitter energy passes to the antenna. The neon tube across the receiver input terminals is merely a protective measure in case the receiver relay fails to operate or has dirty contacts. A similar arrangement for use with coaxial transmission line is illustrated in Figure 1B. In this case, since the velocity factor for polyethylene-filled coaxial cable is approximately 0.67 or 2/3, the actual physical length of the quarter-wave sections of line should be 2/3 of a quarter wave so that the electrical length will be one-quarter wave.

Effect of Feed System on Radiation Angle A vertical radiator for general coverage u-h-f use should be made either ¼ or ½ wavelength long. Longer antennas do not have their maximum radiation at right angles to the line of the radiator (unless co-phased), and, therefore, are not practicable for use where greatest possible radiation parallel to the earth is desired.

Unfortunately, a feed system which is not perfectly balanced and does some radiating, not only robs the antenna itself of that much power, but *distorts the radiation pattern of the antenna*. As a result, the pattern of a vertical radiator may be so altered that the radiation is bent upwards slightly, and the amount of power leaving the antenna *parallel to the earth* is greatly reduced. A vertical half-wave radiator fed at the bottom by a quarter-wave stub is a good example of this; the slight radiation from the matching section decreases the power radiated parallel to the earth by nearly 10 db.

The only cure is a feed system which does not disturb the radiation pattern of the antenna itself. This means that if a

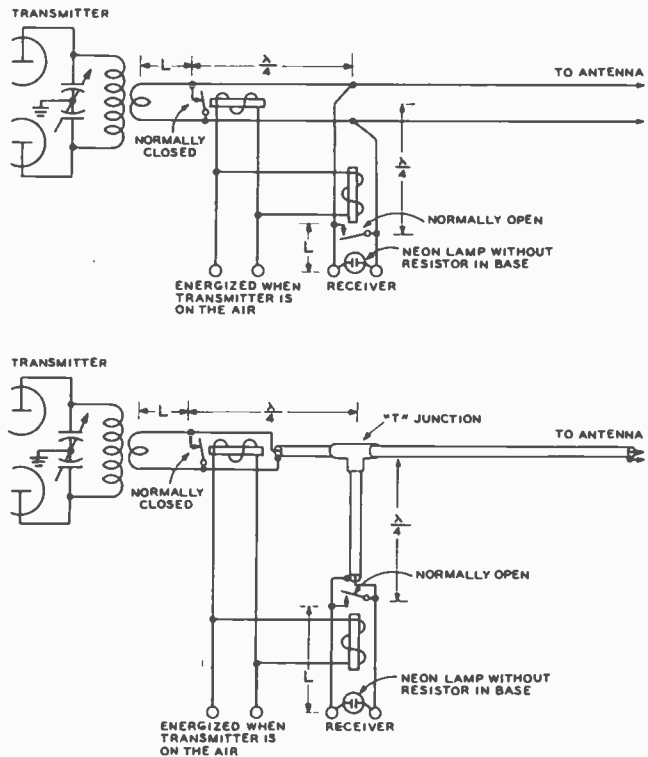

Figure 1. ANTENNA CHANGEOVER SYSTEM FOR V.H.F.

Two quarter-wave sections of transmission line are used in conjunction with a pair of relays to accomplish antenna changeover between the transmitter and the receiver. Description of the operation of the circuit is given in the text.

2-wire line is used, the current and voltages must be exactly the same (though 180° out of phase) at any point on the feed line. It means that if a concentric feed line is used, there should be no current flowing at all on the outside of the outer conductor.

Means for keeping the feed line out of strong fields where it connects to the radiator are discussed later in the chapter in descriptions of specific antenna systems. The unwanted currents induced in the feed line will be negligible when this precaution is taken.

Radiator Cross Section In the previous chapter, the statement was made that there is no point in using copper tubing for an antenna (on the medium frequencies). The reason is that considerable tubing would be required, and the cross section still would not be a sufficiently large fraction of a wavelength to improve the antenna characteristics. At very high and ultra high frequencies, however, the radiator length is so short that the expense of large diameter conductor is relatively small, even though copper pipe of 1 inch cross section is used. With such conductors, the antenna will tune much more broadly, and often a broad resonance characteristic is desirable. This is particularly true when an antenna or array is to be used over an entire amateur band.

It should be kept in mind that with such large cross section radiators, the resonant length of the radiator will be somewhat shorter, being only slightly greater than 0.90 of a half wavelength for a dipole when heavy copper pipe is used above 100 Mc.

Insulation The matter of insulation is of prime importance at ultra high frequencies. Many insulators that have very low losses as high as 30 Mc. show up rather poorly

at frequencies above 100 Mc. Even the low loss ceramics are none too good where the r-f voltage is high. One of the best and most practical insulators for use at this frequency is polystyrene (Victron, etc.). It has one disadvantage, however, in that it is subject to fracture and to deformation in the presence of heat.

It is common practice so to design v-h-f and u-h-f antenna systems that the various radiators are supported only at points of relatively low voltage, the best insulation, obviously, being air. The voltages on properly operated *untuned* feed lines are not high, and the question of insulation is not quite so important, though it still should be of good grade.

Antenna Commercial broadcasting in the U.S.A. for both FM and television in the v-h-f range has been standardized on horizontal polarization.

Polarization One of the main reasons for this standardization was the fact that ignition interference is reduced through the use of a polarized receiving antenna. Amateur practice, however, is divided between horizontal and vertical polarization in the v-h-f and u-h-f range. Mobile stations are invariably vertically polarized due to the physical limitations imposed by the automobile antenna installation. Most of the stations doing intermittent or occasional work on these frequencies use a simple ground-plane vertical antenna for both transmission and reception. However, those stations doing serious work and striving for maximum-range contacts on the 50-Mc. and 144-Mc. bands almost invariably use horizontal polarization.

Experience has shown that there is a great attenuation in signal strength when using crossed polarization (transmitting antenna with one polarization and receiving antenna with the other) for all normal "pre-skip" contacts on these bands. When contacts are being made through sporadic-E reflection, however, the use of crossed polarization seems to make no discernible difference in signal strength. So the operator of a station doing v-h-f work (particularly on the 50-Mc. band) is faced with a problem: If contacts are to be made with all stations doing work on the same band, provision must be made for operation on both horizontal and vertical polarization. This problem has been solved in many cases through the construction of an antenna array that may be revolved in

Frequency in Mc.	1/4 Wave Free Space	1/4 Wave Antenna	1/2 Wave Free Space	1/2 Wave Antenna
50.0	59.1	55.5	118.1	111.0
50.5	58.5	55.0	116.9	109.9
51.0	57.9	54.4	115.9	108.8
51.5	57.4	53.9	114.7	107.8
52.0	56.8	53.4	113.5	106.7
52.5	56.3	52.8	112.5	105.7
53.0	55.7	52.4	111.5	104.7
54.0	54.7	51.4	109.5	102.8
<hr/>				
144	20.5	19.2	41.0	38.5
145	20.4	19.1	40.8	38.3
146	20.2	18.9	40.4	38.0
147	20.0	18.8	40.0	37.6
148	19.9	18.6	39.9	37.2
<hr/>				
235	12.6	11.8	25.2	23.6
236	12.5	11.8	25.1	23.5
237	12.5	11.7	25.0	23.5
238	12.4	11.7	24.9	23.4
239	12.4	11.6	24.8	23.3
240	12.3	11.6	24.6	23.2
<hr/>				
420	7.05	6.63	14.1	13.25
425	6.95	6.55	13.9	13.1
430	6.88	6.48	13.8	12.95

All dimensions are in inches. Lengths have in most cases been rounded off to three significant figures. "1/2-Wave Free-Space" column shown above should be used with Lecher wires for frequency measurement.

the plane of polarization in addition to being capable of rotation in the azimuth plane. Several antennas of this type are described in Chapter 30.

An alternate solution to the problem which involves less mechanical construction is simply to install a good ground-plane vertical antenna for all vertically-polarized work, and then to use a multi-element horizontally-polarized array for dx work and for use when sporadic-E propagation is possible.

29-2 Horizontally-Polarized Arrays

As has been mentioned before, antenna systems which do not concentrate radiation at the very low elevation angles are not recommended for v-h-f and u-h-f work. It is for this reason that the horizontal dipole and horizontally-disposed colinear arrays are generally unsuitable for work on these frequencies. Arrays using broadside or end-fire elements do concentrate radiation at low elevation angles and are recommended for v-h-f work. Arrays such as the lazy-H, Sterba curtain, flat-top beam, and arrays with parasitically excited elements are recommended for this work. Dimensions for the first three types of arrays may be determined from the data given in the previous chapter, and reference may be made to the *Table of Wavelengths* given in this chapter.

Arrays using vertically-stacked horizontal dipoles, such as are used by commercial television and FM stations, are capable of giving very high gain *without* a sharp horizontal radiation pattern. If sets of crossed dipoles, as shown in Figure 2A, are fed 90° out of phase the resulting system is called a "turnstile" antenna. The 90° phase difference between sets of dipoles may be obtained by feeding one set of dipoles with a feed line which is one-quarter wave longer than the feed line to the other set of dipoles. The free-space theoretical gain of an antenna such as shown is about 5 db over a half-wave dipole, but in actual practice on the v-h-f bands a considerably greater effective gain will be obtained in *all* directions simultaneously over a dipole. If the second set of four dipoles is placed one-quarter wave behind the first set and parasitically excited from the dipoles as a reflector (or as a director) approximately 10 db gain will be obtained and the horizontal pattern of the array will still be moderately broad. The majority of the gain in arrays of this type comes from con-

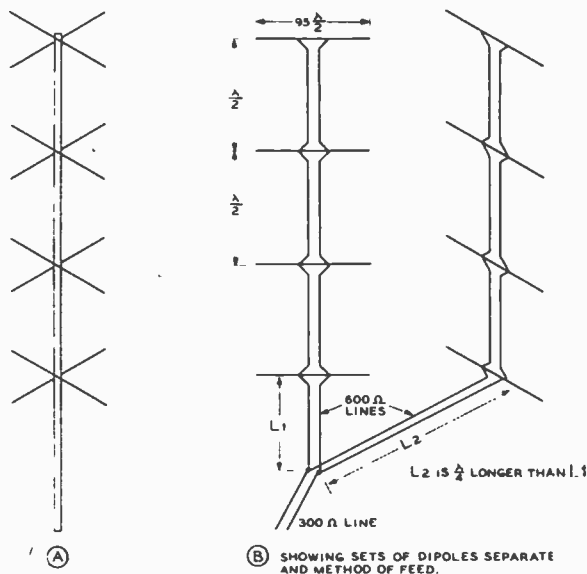

Figure 2. STACKED-TURNSTILE LOW-ANGLE NON-DIRECTIONAL ARRAY.

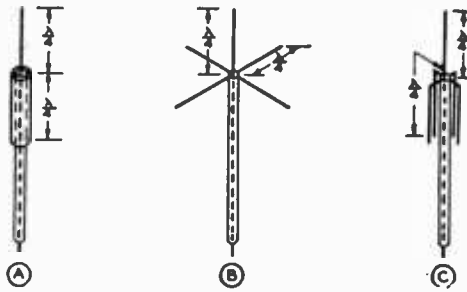

Figure 3.

THREE TYPES OF VERTICAL LOW-ANGLE RADIATORS.

At (A) is shown the "sleeve" or "hypodermic" type of coaxial radiator. The bottom half of the radiator consists of a piece of large-diameter pipe through which the support pipe and the coaxial cable run. At (B) is illustrated the ground-plane vertical and at (C) is shown a modification of this antenna.

centration of substantially all radiation from the array at the useful low angles of radiation.

The array with several parasitically-excited elements is meeting with increasing favor for operation on the v-h-f's. Detailed discussion of the element lengths, method of feed, installation and tuning of such arrays is given in Chapter 30.

29-3 Vertically-Polarized Antennas and Arrays

For general coverage with a single antenna, a single vertical radiator is commonly employed. A 2-wire open transmission line is not suitable for use with this type antenna, and coaxial polyethylene feed line such as RG-8/U is to be recommended. Three practical methods of feeding the radiator with concentric line, with a minimum of current induced in the outside of the line, are shown in Figure 3. Antenna (A) is known as the "Sleeve" antenna, the lower half of the radiator being a large piece of pipe up through which the concentric feed line is run. At (B) is shown the ground-plane vertical, and at (C) a modification of this same array.

The radiation resistance of the ground-plane vertical is approximately 30 ohms, which is not a standard impedance for concentric line. To obtain a good match, the first quarter wavelength of feeder may be of 52 ohms surge impedance, and the remainder of the line of approximately 75 ohms impedance. Thus, the first quarter-wave section of line is used as a matching transformer, and a good match is obtained.

In actual practice the antenna would consist of a quarter-wave rod, mounted by means of insulators atop a pole or pipe mast. Elaborate insulation is not required, as the voltage at the lower end of the quarter-wave radiator is very low. Self-supporting rods from 0.25 to 0.28 wavelength would be extended out, as in the illustration, and connected together. As the point of connection is effectively at ground potential, no insulation is required; the horizontal rods may be bolted directly to the supporting pole or mast, even if of metal. The concentric line should be of the low loss type especially designed for v-h-f use. The outside connects to the junction of the radials, and the inside to the bottom end of the vertical radiator.

The modification at (C) permits matching to a standard 50- or 70-ohm flexible coaxial cable without a linear transformer. If the lower rods hug the line and supporting mast rather closely, the feed-point impedance is about 70 ohms. If they are bent out to form an angle of about 30° with the support pipe the impedance is about 50 ohms.

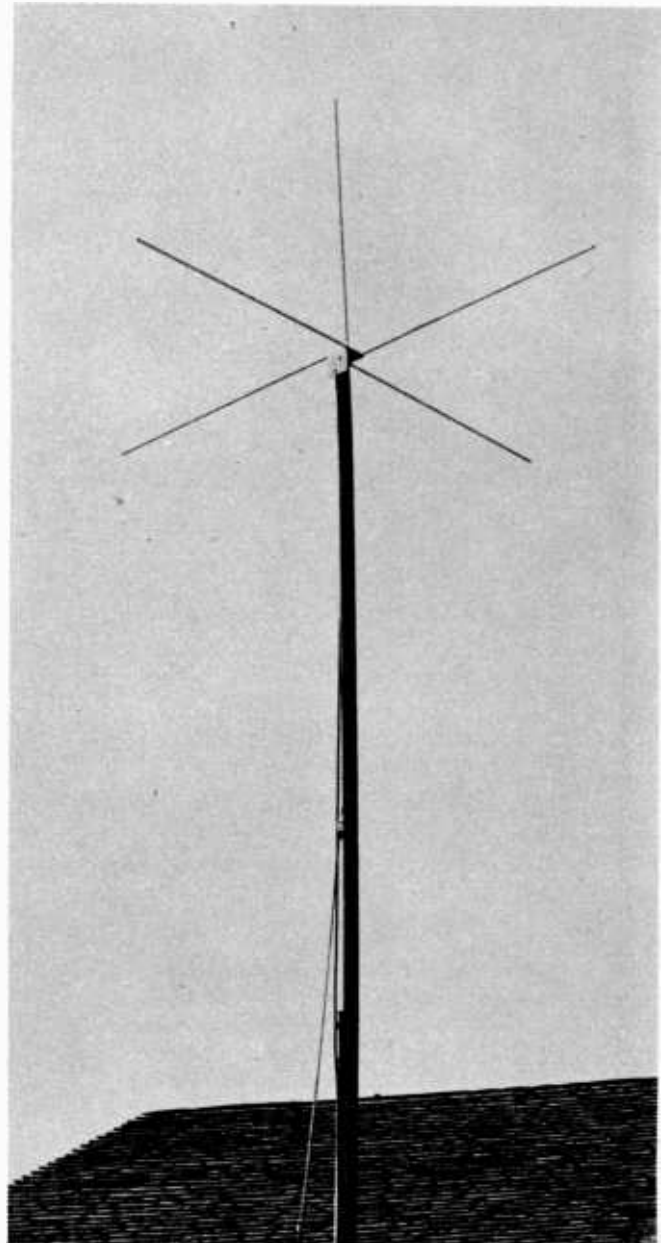

Figure 4.

50-MC. GROUND-PLANE VERTICAL ANTENNA.

See Figure 5 for construction.

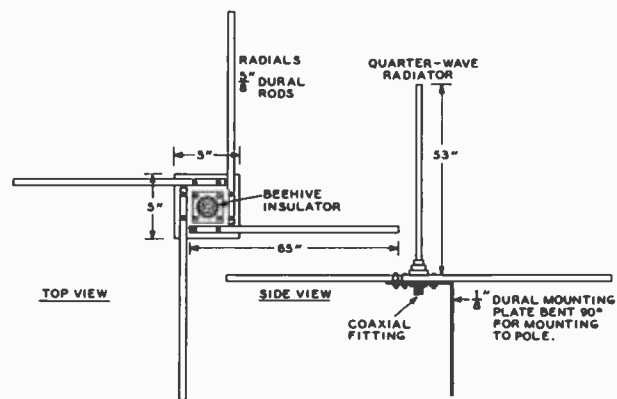

Figure 5.

CONSTRUCTION DETAILS OF THE GROUND-PLANE VERTICAL SHOWN IN FIGURE 4.

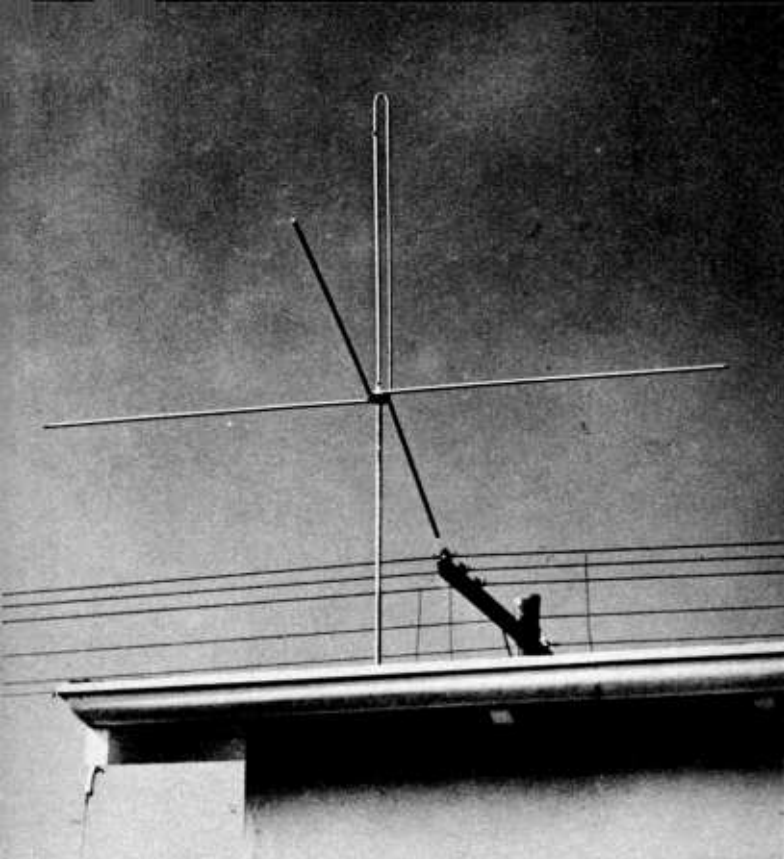

Figure 6.
GROUND-PLANE "FOLDED-UNIPOLE" ANTENNA.
See Figure 7 for construction details.

Construction of the Ground-Plane Vertical Figure 4 is a photograph of a relatively simple ground-plane vertical antenna suitable for the v-h-f range. The mechanical construction details of the antenna are given in Figure 5. An antenna of this type is moderately simple to construct and will give a good account of itself when fed at the lower end of the radiator directly by the 52-ohm RG-8/U coaxial cable. Theoretically the standing-wave ratio will be approximately 2-to-1 but in practice this moderate s-w-r produces no deleterious effects, even on coaxial cable.

An antenna design for a ground-plane vertical which will give a more accurate match to a 70-ohm coaxial cable is illus-

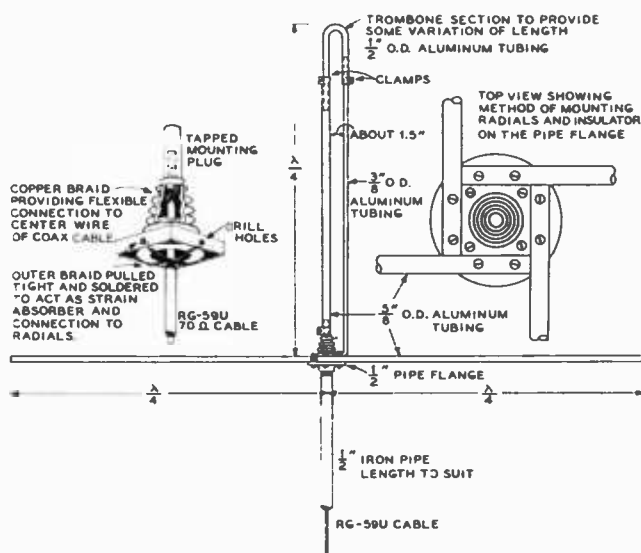

Figure 7.
CONSTRUCTION DETAILS OF THE GROUND-PLANE "FOLDED-UNIPOLE" ANTENNA SYSTEM.

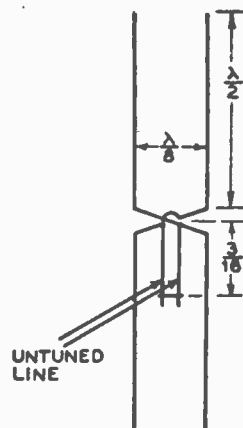

Figure 8.
FLAT-TOP BEAM ORIENTED FOR VERTICAL POLARIZATION.

For data on this antenna array refer to the preceding chapter. The stub and feed line should be equidistant from the two lower radiating elements.

trated in Figure 6 and sketched in Figure 7. This type of ground-plane antenna is often called the *folded-unipole* antenna. The improvement in the match between the feed point on the dipole and the antenna transmission line is obtained by folding the radiator, in the same general manner as used with the folded dipole, grounding one end, and connecting the antenna transmission-line inner conductor to the ungrounded end of the radiator. The use of a folded dipole (or unipole) where both conductors have the same diameter will result in a multiplication of the feed-point impedance by a factor of 4. Since the feed-point impedance at the lower end of a ground-plane vertical is approximately 30 ohms, the use of a folded dipole with the same conductor diameter would give a feed-point impedance of about 120 ohms. Since standard polyethylene coaxial-cable impedances are 52 ohms and 70 ohms, we must use an impedance step up of less than four. If the diameter of the half of the radiator connected to the feed line is made larger than the diameter of the half whose lower end is grounded, the impedance multiplication will be less than four. A detailed discussion of the calculation of conductor sizes for obtaining varying impedance step up ratios is given in Chapter 30. However, suffice to say here that it is impracticable to obtain the small impedance step up from 30 to 52 ohms by this method. It is better merely to tolerate the small standing wave that will be formed on the cable, or to build a quarter-wave coaxial transformer inside the support pipe of the antenna having a characteristic impedance of 38.5 ohms.

It is practicable, however, to match the 30-ohm basic impedance of the antenna to a 70-ohm coaxial cable through the use of the folded-unipole system. The diameter of the grounded half of the folded unipole should be one-quarter inch, and the diameter of the half of the unipole which goes to the inner conductor of the coaxial cable should be 5/8 inch. The center-to-center spacing of the two rods should be one to one and one-half inches. These are the dimensions used in the antenna whose photograph is shown in Figure 6.

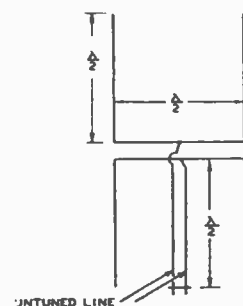

Figure 9.
H-TYPE ARRAY ARRANGED FOR VERTICAL POLARIZATION.

The matching stub feeds the center of the phasing section instead of one end as in the case of horizontal orientation. The stub should be equidistant from the two lower radiators.

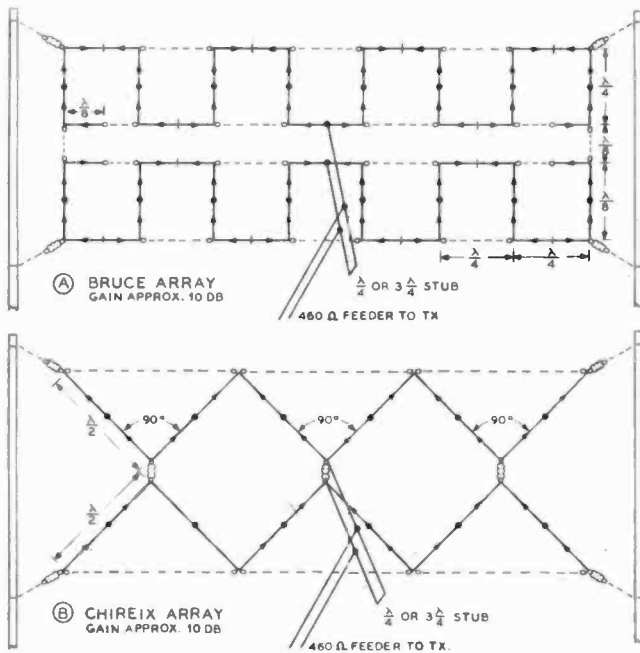

Figure 10.

TWO VERTICALLY-POLARIZED ANTENNA ARRAYS.
A pair of stacked Bruce arrays is shown at (A) and a pair of stacked Chireix arrays is illustrated at (B).

The number of radial legs used in a ground-plane antenna of either type has an important effect on the feed-point impedance and upon the radiation characteristics of the antenna system. Experiment has shown that three radials is the minimum number that should be used, and that increasing the number of radials above four adds substantially nothing to the effectiveness of the antenna and has no effect on the feed-point impedance. Experiment has shown, however, that the radials should be slightly longer than one-quarter wave for best results. A length of 0.28 wavelength has been shown to be the optimum value. This means that the radials for a 50-Mc. ground-plane vertical antenna should be 65" in length.

Vertically-Polarized Arrays Antenna arrays such as the flat-top beam and the lazy-H (when the latter is fed in the center instead of at one end) may be used with the elements vertically oriented to produce vertically-polarized radiation. Typical examples are shown in Figures 8 and 9. Two other types of arrays, which are especially designed for vertical polarization, are shown in Figure 10. It is important in the case of all these arrays that the stub and feed line be brought directly away from the antenna in a plane at right angles to the array for a distance of at least two wavelengths. If the stub or line is closer to

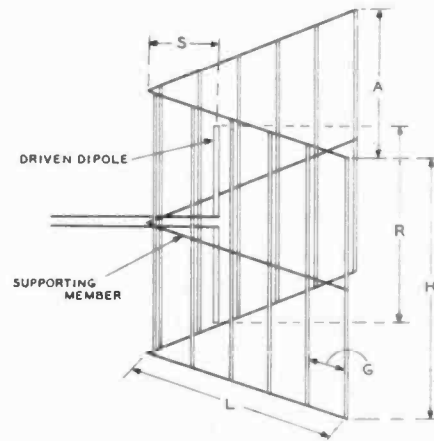

Figure 11.

CORNER-REFLECTOR ANTENNA CONSTRUCTION.

See Corner-Reflector Design Table for data on the dimensions for the antenna system.

one radiator than the other undesired currents will be induced in the feed line.

29-4 The Corner-Reflector Antenna

The corner-reflector antenna is a particularly good directional radiator for the v-h-f and u-h-f region. The antenna may be used with the radiating element vertical, in which case the directivity is in the horizontal or azimuth plane, or the system may be used with the driven element horizontal in which case the radiation is horizontally polarized and most of the directivity is in the vertical plane. With the antenna used as a horizontally polarized radiating system the array is a very good low-angle beam array although the nose of the horizontal pattern is still quite sharp. When the radiator is oriented vertically the corner reflector operates very satisfactorily as a direction-finding antenna.

Design data for the corner-reflector antenna is given in the chart *Corner-Reflector Design Data*. The planes which make up the reflecting corner may be made up of solid sheets of copper or aluminum for the u-h-f bands, although spaced wires with the ends soldered together at top and bottom may be used as the reflector on the lower frequencies. Copper screen may also be used for the reflecting planes.

The values of spacing given in the corner-reflector chart have been chosen such that the center impedance of the driven element would be approximately 70 ohms. This means that a quarter-wave matching transformer such as a "Q" section may be used to provide an impedance match between the center-impedance of the element and a 460-ohm line constructed of no. 12 wire spaced 2 inches.

CORNER-REFLECTOR DESIGN DATA

Corner Angle	Freq. Band, Mc.	R	S	H	A	L	G	Feed Imped.	Gain, db
90°	50	110"	82"	140"	200"	230"	18"	72	10
60°	50	110"	115"	140"	230"	230"	18"	70	12
60°	144	38"	40"	48"	100"	100"	5"	70	12
60°	235	23.5"	25"	30"	72"	72"	3"	70	12
60°	420	13"	14"	18"	36"	36"	screen	70	12

NOTE: Refer to Figure 11 for construction of corner-reflector antenna.

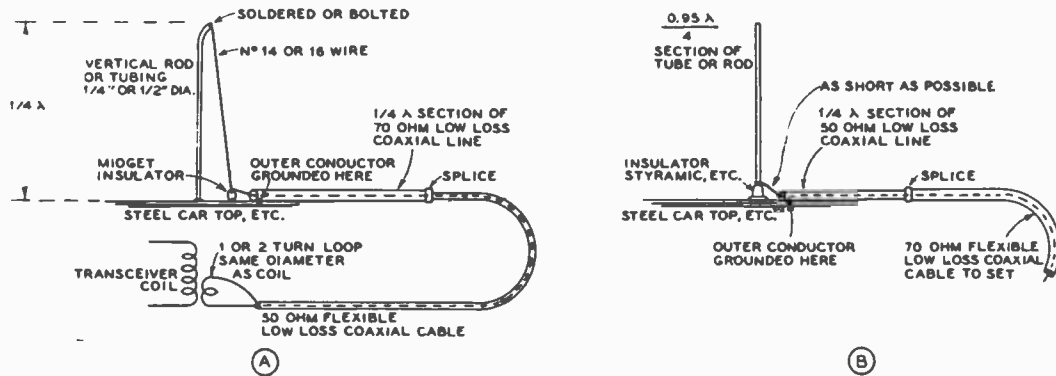

Figure 12.
ANTENNAS FOR MOBILE INSTALLATIONS.

29-5 V-H-F Mobile Antennas

A quite satisfactory mobile antenna for the 27 to 29.7 Mc. and the 50 to 54 Mc. ranges consists of a quarter-wave vertical whip antenna mounted by means of an insulating mount arrangement on the rear bumper of the automobile. A satisfactory feed method consists of a short piece of 52-ohm coaxial cable run from the base of the antenna to the antenna changeover switch and then to the link around the final amplifier tank coil. It is often possible to obtain better control of the loading imposed by the antenna on the transmitter output circuit by placing a 50- μ fd. APC variable capacitor in series with the lead from the inner conductor of the coaxial cable to the link coil. Somewhat greater field strength may be obtained through the use of an antenna of greater length on the 50-Mc. band where greater lengths are practicable. If the antenna approaches a half wave in length a better impedance match will be obtained through the use of a parallel-tuned circuit in a shielded and weather-protected box at the base of the antenna. The tuned circuit at the base of the antenna should be link coupled to the coaxial cable running to the antenna changeover switch.

A quarter-wave antenna grounded at the base may also be used for mobile work. In this case the antenna may be fed by means of a single-wire feeder tapped approximately 30 per cent up from the grounded base of the antenna, or the antenna may be fed by the method shown in Figure 12A. The system shown in Figure 12A is primarily recommended for operation on the 144-Mc. band and higher in frequency.

When the system shown in Figure 12A is used, the bottom of the rod or tubing is bolted, welded or otherwise fastened to

the metal portion of the car. The tip of the rod is bent slightly so that when the parallel wire is fastened as shown in the illustration, the wire is held away from the rod sufficiently that it will not whip against the rod as a result of wind or vibration. The wire is anchored by means of a midjet insulator, and pulled taut enough that the rod or tubing section bends slightly. Keeping the wire under slight tension will aid in preventing the wire from whipping against the grounded rod or tubing, which would cause the antenna to work erratically.

The outside conductor of the coaxial cable is soldered to the base of the vertical rod, and the inner conductor is soldered to the bottom of the vertical wire where it fastens to the midjet insulator. The variation shown at (B) is self-explanatory.

In the case of all mobile antenna systems it is always wise to undertake the tuning of the antenna system with the aid of a field-strength meter. One of the simple f-s meters shown in Chapter 31 will be satisfactory. With the field-strength meter as an indicator the length of the whip, the tuning of the antenna network if used, and the coupling to the final amplifier may be varied until the maximum value of field strength is obtained. Also, it will almost invariably be noticed that a mobile antenna installation on an automobile, particularly when it is mounted on the back bumper, will have quite pronounced directional effects. The degree of this effect and the direction for maximum field strength may be determined with the aid of the field-strength meter. In most cases of an antenna installation on the back bumper of the car it will be found that the directivity of the antenna is greatest in the direction through the body of the automobile.

Rotatable Antenna Arrays

THE rotatable antenna array has become almost standard equipment for operation on the 28-Mc. and 50-Mc. bands and is very commonly used on the 14-Mc. band and on those frequencies above 144 Mc. The rotatable array offers many advantages for amateur use. The directivity of the antenna types commonly employed, particularly the unidirectional arrays, offers a worthwhile reduction in interference from undesired directions. Also, the increase in the ratio of low-angle radiation plus the theoretical gain of such arrays results in a relatively large increase in both the transmitted signal and the signal intensity from a station being received.

A significant advantage of a rotatable antenna array in the case of the normal station is that a relatively small amount of real estate is required for erection of the antenna system. In fact, one of the best types of installations uses a single telephone pole with the rotating structure holding the antenna mounted atop the pole. To obtain results in all azimuth directions from fixed arrays comparable to the gain and directivity of a single rotatable three-element parasitic beam would require several acres of surface.

As has been mentioned in Chapters 12 and 28, the most important consideration in dx work is that of obtaining a low angle of radiation. Azimuth directivity is desirable if not carried too far but a low radiation angle is a necessity. It was also mentioned that there are two normal configurations of radiating elements which, when horizontally polarized, will contribute to obtaining a low angle of radiation. These configurations are the end-fire array and the broadside array. The conventional three- or four-element rotary beam may properly be called a *unidirectional parasitic end-fire array*. The flat-top beam is a type of *bidirectional end-fire array*. The *broadside type* of array is also quite effective in obtaining low-angle radiation, and although widely used in FM broadcasting has seen little use by amateur stations in rotatable arrays. All three of these types of arrays, and their use on rotating structures, will be described in this chapter.

30-1 Unidirectional Parasitic End-Fire Arrays ("Three-Element Rotary" Type)

If a single parasitic element is placed on one side or the other of a driven dipole at a distance of from 0.1 to 0.25 wave-

length the parasitic element can be tuned to make the array unidirectional.

Two-Element Array The optimum spacing for a reflector in a two-element array is approximately 0.15 wavelength and with optimum adjustment of the length of the reflector a gain of approximately 5 db will be obtained. With this adjustment for maximum forward gain (the reflector will be approximately equal to $\frac{492}{F_{Mc.}}$ ft.) the radiation resistance of the driven dipole is approximately 25 ohms.

If the parasitic element is to be used as a director the optimum spacing between it and the driven element is 0.1 wavelength. The director will be found to be approximately $0.90 \times \frac{492}{F_{Mc.}}$ (somewhat shorter than the driven element) and the gain will theoretically be slightly greater than with the optimum adjustment for a reflector but the radiation resistance will be in the vicinity of 15 ohms.

In both the case of the director and the reflector in a two-element array the point of adjustment for maximum forward gain will be found to be somewhat different from that for maximum front-to-back ratio. The two adjustments are quite close together and either one may be chosen, depending upon the operating conditions desired. A sacrifice of approximately 1.0 db in forward gain is involved when the two-element array is adjusted for maximum front-to-back ratio.

The two-element array is most frequently used on the 14-Mc. band where the size of the supporting structure would become prohibitive with a larger number of elements. A representative two-element 14-Mc. array with the parasitic element operating as a director at 0.125 wavelength spacing is shown in Figure 1.

Three Elements and More The use of two parasitic elements instead of one adds little to the mechanical difficulties of rotation, and the gain and discrimination (especially the latter) are considerably improved over that obtained with a single director or a single reflector instead of a combination of both. The three-element array using a close-spaced director, driven element, and close-spaced reflector will exhibit as much as 30 db front-to-back ratio and 20 db front-to-side ratio for *low angle radiation*. The theoretical gain

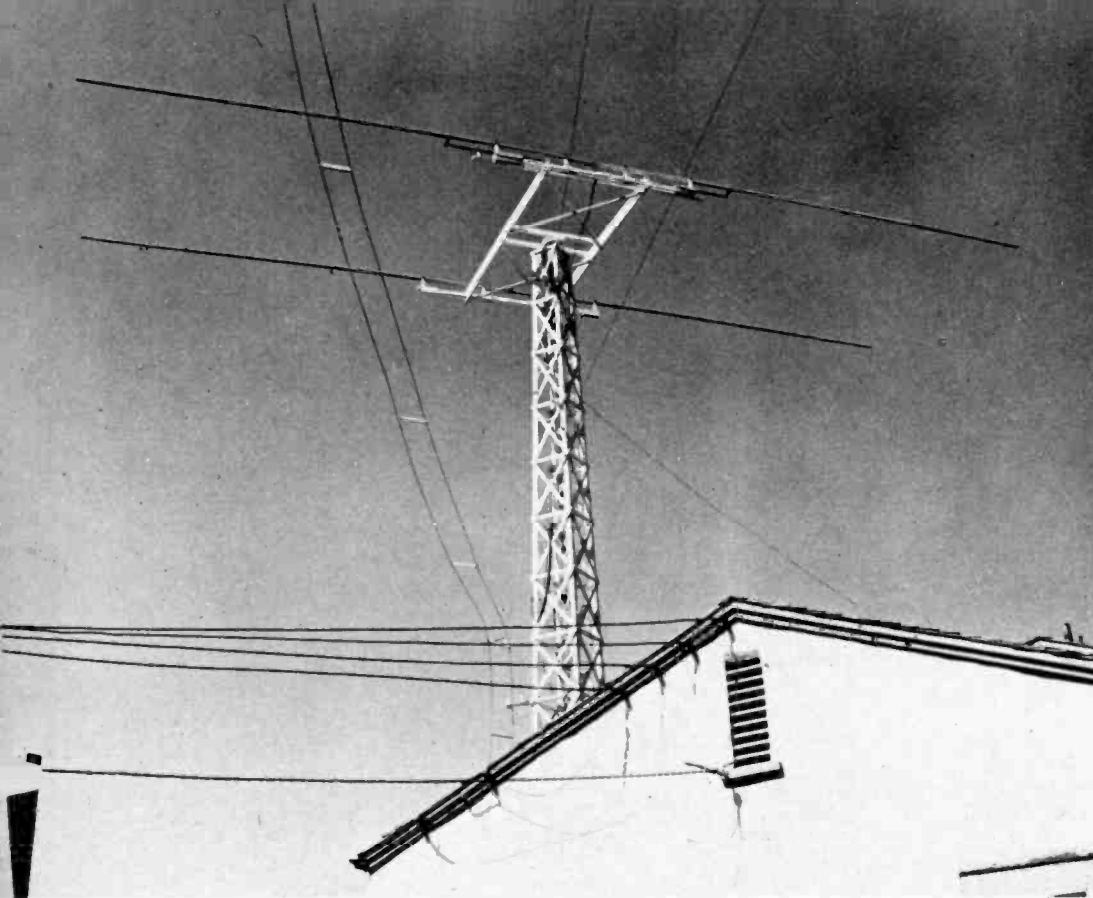

Figure 1.
TYPICAL TWO-ELEMENT 14-MC. ROTATABLE ARRAY.

is approximately 8 db over a dipole in free space. In actual practice, the array will often show 10 db or more gain over a horizontal dipole placed the same height above ground (at 28 and 14 Mc.).

The use of more than three elements is desirable when the length of the supporting structure is such that spacings of approximately 0.2 wavelength between elements becomes possible. Four-element arrays are quite common on the 28-Mc. and 50-Mc. bands, and five elements are sometimes used for increased gain and discrimination. As the number of elements is increased the gain and front-to-back ratio increases but the radiation resistance decreases and the bandwidth or frequency range over which the antenna will operate without reduction in effectiveness is decreased.

The gain of a properly adjusted four-element array is approximately 9 db over a dipole at the same height and the five-element system will show about 1 db additional gain over the four-element. The apparent gain, however, will be somewhat greater due to increased low-angle radiation.

Material for Elements While the elements may consist of wire supported on a wood framework, self-supporting elements of tubing are much to be preferred.

The latter type array is easier to construct, looks better, is no more expensive, and avoids the problem of getting sufficiently good insulation at the ends of the elements. The voltages reach such high values towards the ends of the elements that losses will be excessive, unless the insulation is excellent.

The elements may be fabricated of thin-walled steel conduit, or hard drawn thin-walled copper tubing, but dural tubing is much better. Or, if you prefer, you may purchase tapered copper-plated steel tubing elements designed especially for the purpose. Kits are available complete with rotating mechanism and direction indicator, for those who desire to purchase the whole "works" ready to put up.

Element Spacing and Length The optimum spacing for a two-element array is, as has been mentioned before, approximately 0.1 wavelength for a director and 0.15 wavelength for a reflector. However, when both a

director and a reflector are combined with the driven element to make up a three-element array the optimum spacing is approximately 0.2 wavelength between the driven element and either of the two parasitic elements. This same spacing is also satisfactory for arrays using more than three elements. Less spacing may be used but the bandwidth, gain, and radiation resistance will decrease.

The optimum length for the parasitic elements in a multi-element array becomes more critical as the spacing between the elements is decreased. For 0.1 or 0.15 wavelength spacing the elements can best be adjusted to the optimum length, using $\frac{492}{F_{Mc.}}$ for the reflector, $0.94 \times \frac{492}{F_{Mc.}}$ for the driven element, and $0.90 \times \frac{492}{F_{Mc.}}$ for the director as starting dimensions.

When the spacing between elements is made 0.2 wavelength, however, it is quite practicable merely to adjust the elements

UNIDIRECTIONAL PARASITIC END-FIRE ARRAYS								
ANTENNA TYPE	DRIVEN ELEMENT LENGTH	REFLECTOR LENGTH	FIRST DIRECTOR LENGTH	SECOND DIRECTOR LENGTH	THIRD DIRECTOR LENGTH	SPACING BETWEEN ELEMENTS	APPROX. GAIN DB	APPROX. RAD. RES. OHMS
2-ELEMENT USING REFLECTOR	$\frac{492}{F_{Mc.}}$	$\frac{480}{F_{Mc.}}$	MAXIMUM GAIN			0.15	5.3	24
2-ELEMENT USING REFLECTOR	$\frac{482}{F_{Mc.}}$	$\frac{493}{F_{Mc.}}$	MAXIMUM FRONT-TO-BACK RATIO			0.15	4.3	30
2-ELEMENT USING DIRECTOR	$\frac{492}{F_{Mc.}}$	—	$\frac{492}{F_{Mc.}}$	MAXIMUM GAIN		0.1	5.5	14
2-ELEMENT USING DIRECTOR	$\frac{482}{F_{Mc.}}$	—	$\frac{445}{F_{Mc.}}$	MAXIMUM FRONT-TO-BACK RATIO		0.1	4.6	26
3-ELEMENT 0.1 λ SPACING	$\frac{492}{F_{Mc.}}$	$\frac{493}{F_{Mc.}}$	$\frac{444}{F_{Mc.}}$	—	—	0.1	7.0	5
3-ELEMENT 0.2 λ SPACING	$\frac{492}{F_{Mc.}}$	$\frac{498}{F_{Mc.}}$	$\frac{450}{F_{Mc.}}$	—	—	0.2	9.0	18
3-ELEMENT 0.25 λ SPACING	$\frac{492}{F_{Mc.}}$	$\frac{493}{F_{Mc.}}$	$\frac{450}{F_{Mc.}}$	—	—	0.25	9.0	30
4-ELEMENT 0.2 λ SPACING	$\frac{482}{F_{Mc.}}$	$\frac{490}{F_{Mc.}}$	$\frac{442}{F_{Mc.}}$	$\frac{438}{F_{Mc.}}$	—	0.2	10.0	13
5-ELEMENT 0.2 λ SPACING	$\frac{482}{F_{Mc.}}$	$\frac{490}{F_{Mc.}}$	$\frac{442}{F_{Mc.}}$	$\frac{438}{F_{Mc.}}$	$\frac{434}{F_{Mc.}}$	0.2	11.0	10

Figure 2.

DESIGN CHART FOR CONVENTIONAL PARASITIC ARRAYS.

The values of gain and effective radiation resistance given for the multi-element arrays are subject to considerable variation as a result of the tuning of the elements, but the quantities given can be assumed to be average values. Dimensions are in feet.

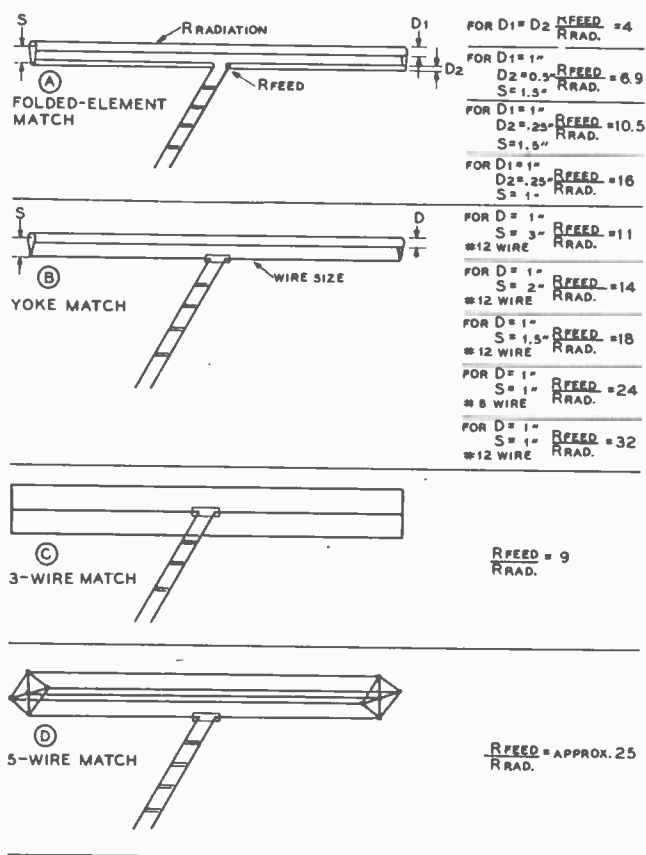

Figure 3.

DESIGN DATA FOR FOLDED-ELEMENT MATCHING SYSTEMS.

In all normal applications of the data given the main element shown is the driven element of a multi-element parasitic array. Directors and reflectors have not been shown for the sake of clarity. The ratio of impedance step-up for a number of possible combinations is listed to the right of the sketches.

to length and install the antenna system. Further adjustment will add little to performance. A table of recommended dimensions for multi-element parasitic arrays is given in Figure 2.

30-2 Feed Systems For Parasitic End-Fire Arrays

The table of Figure 2 gives, in addition to other information, the approximate radiation resistance referred to the center of the driven element of multi-element parasitic arrays. It is obvious, from these low values of radiation resistance, that especial care must be taken in materials used and in the construction of the elements of the array to insure that ohmic losses in the conductors will not be an appreciable percentage of the radiation resistance. It is also obvious that some method of impedance transformation must be used to match the low radiation resistance of these antenna arrays to the normal range of characteristic impedance used for antenna transmission lines.

A group of possible methods of impedance matching is shown in Figures 3, 4, and 5. All these methods have been used but certain of them offer advantages over some of the other methods. Generally speaking it is not desirable to break the center of the driven element of an array for feeding the system. Breaking the driven element rules out the practicability of building an all-metal or "plumber's delight" type of array, and imposes mechanical limitations with any type of construction. However, when continuous rotation is desired, an arrangement such as shown in Figure 5D, utilizing a broken driven element with a rotatable transformer for coupling from

the antenna transmission line to the driven element has proven to be quite satisfactory. In fact the method shown in Figure 5D is probably the most practicable method of feeding the driven element when continuous rotation of the antenna array is required.

The feed systems shown in Figure 3 will, under normal conditions, show the lowest losses of any type of feed system since the currents flowing in the matching network are the lowest of all the systems commonly used. The "Folded Element" match shown in Figure 3A and the "Yoke" match shown in Figure 3B are the most satisfactory electrically of all standard feed methods. However, both methods require the extension of an additional conductor out to the end of the driven element as a portion of the matching system. The folded-element match is best on the 50-Mc. band and higher where the additional section of tubing may be supported below the main radiator element without undue difficulty. The yoke-match is more satisfactory mechanically on the 28-Mc. and 14-Mc. bands since it is only necessary to suspend a wire below the driven element proper. The wire may be spaced below the self-supporting element by means of several small strips of polystyrene which have been drilled for both the main element and the small wire and threaded on the main element.

The Folded-Element Match Calculations

The calculation of the operating conditions of the folded-element matching system and the yoke match, as shown in Figures 3A and 3B is relatively simple. A selected group of operating conditions have been shown on the drawing of Figure 3. In applying the system it is only necessary to multiply the ratio of feed to radiation resistance (given in the figures to the right of the suggested operating dimensions in Figure 3) by the radiation resistance of the antenna system to obtain the impedance of the cable to be used in feeding the array. Approximate values of radiation resistance for a number of commonly used parasitic-element arrays are given in Figure 2.

As an example, suppose a 3-element array with 0.2-wave-length spacing between elements is to be fed by means of a 465-ohm line constructed of no. 12 wire spaced 2 inches. Figure 2 shows that the approximate radiation resistance of the antenna array will be 18 ohms. Hence we need a ratio of impedance step up of 26 to obtain a match between the characteristic impedance of the transmission line and the radiation resistance of the driven element of the antenna array. Inspection of the ratios given in Figure 3 shows that the fourth set of dimensions given under Figure 3B will give a 24-to-1 step up, which is sufficiently close. So it is merely necessary to use a 1-inch diameter driven element with a no. 8 wire spaced 1 inch centers (1/2 inch below the outside wall of the 1-inch tubing) below the 1-inch element. The no. 8 wire is broken and a 2-inch insulator placed in the center. The feed line then carries from this insulator down to the transmitter. The center insulator should be supported rigidly from the 1-inch tube so that the spacing between the piece of tubing and the no. 8 wire will be accurately maintained.

In many cases it will be desired to use the folded-element or yoke matching system with different sizes of conductors or different spacings than those shown on Figure 3. Note, then, that the impedance transformation ratio of these types of matching systems is dependent both upon the ratio of conductor diameters and upon their spacing. The following equation has been given by Roberts (*RCA Review*, June, 1947) for the determination of the impedance transformation when using different diameters in the two sections of a folded element:

$$\text{Transformation ratio} = \left(1 + \frac{Z_1}{Z_2}\right)^2$$

In this equation Z₁ is the characteristic impedance of a line

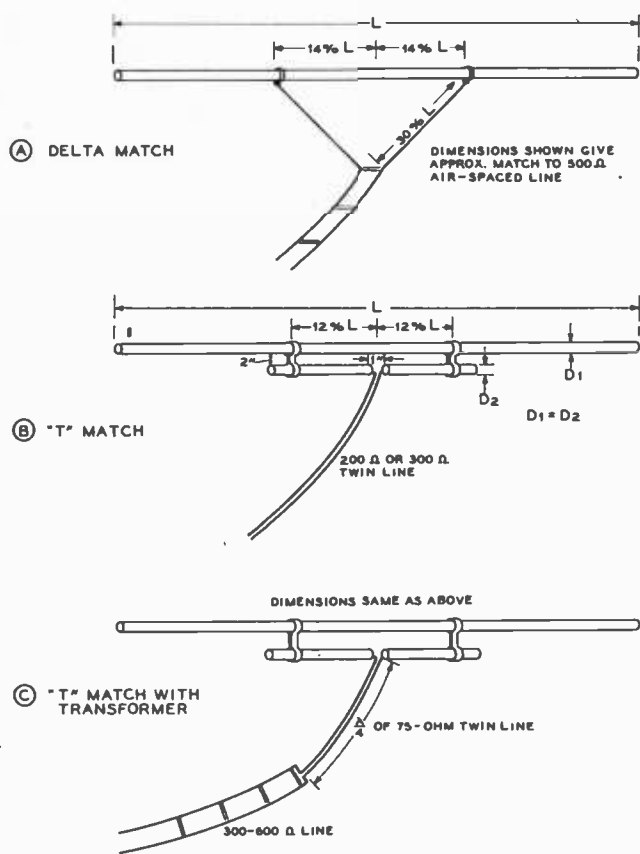

Figure 4. AVERAGE DIMENSIONS FOR THE DELTA AND "T" MATCH.

made up of the smaller of the two conductor diameters spaced the center-to-center distance of the two conductors in the antenna, and Z_1 is the characteristic impedance of a line made up of two conductors the size of the larger of the two. This assumes that the feed line will be connected in series with the *smaller* of the two conductors so that an impedance step up of greater than four will be obtained. If an impedance step up of less than four is desired, the feed line is connected in series with the *larger* of the two conductors and Z_1 in the above equation becomes the impedance of a hypothetical line made up of the larger of the two conductors and Z_1 is made up of the smaller. The folded unipole described in the previous chapter is a case where the feed line is connected in series with the larger of the two conductors.

The conventional 3-wire match to give an impedance multiplication of 9 and the 5-wire match to give a ratio of approximately 25 are shown in Figures 3C and 3D. The 4-wire match, not shown, will give an impedance transformation ratio of approximately 16.

Delta Match and "T" Match The delta match and the "T" match are shown in Figure 4. Both these systems are widely used and can be adjusted to give a reasonable standing-wave ratio on 300 to 600 ohm feed line. In the case of all three of the systems shown it will be necessary to make adjustments in the tapping distance along the driven radiator until minimum standing waves on the antenna transmission line are obtained. Since it is sometimes impracticable to eliminate completely the standing waves from the antenna transmission line, it is common practice to cut the feed line, after standing waves have been reduced to a mini-

mum, to a length which will give satisfactory loading of the transmitter over the desired frequency range of operation.

In cases where it does not prove practicable to obtain a satisfactorily low standing wave ratio when using the "T" match to the driven element the arrangement shown at Figure 4C has proven very helpful. In those cases where the standing-wave ratio cannot be reduced to a sufficiently low value it has been found that the impedance at the feed point in the "T" section is *lower* than that of the antenna transmission line. Hence the inclusion of a quarter-wave transformer between this feed point and the feed line will present a higher impedance to the antenna transmission line. In all cases when using polyethylene-filled line for a matching transformer, the length of the transformer should be *shorter* than $\frac{1}{4}$ wave. The physical length will be $\frac{1}{4}$ wave times the velocity factor of the cable or line being used.

Feed Systems Using a Driven Element with Center Feed Four methods of exciting the driven element of a parasitic array are shown in Figure 5. The system shown at (A) has proven to be quite satisfactory in the case of an antenna-reflector two-element array or in the case of a three-element array with 0.2 to 0.25 wavelength spacing between the elements of the antenna system. The feed-point impedance of the center of the driven element is close enough to the characteristic impedance of the 52-ohm coaxial cable so that the standing-wave ratio on the 52-ohm coaxial cable is of the order of 2-to-1. (B) shows an arrangement for

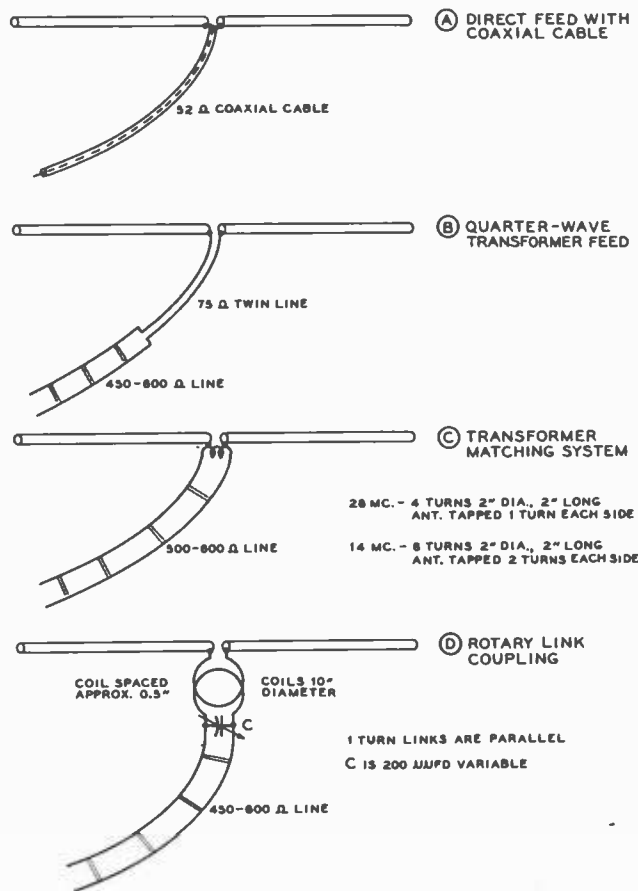

Figure 5. FEED METHODS WHERE THE CENTER ELEMENT IS BROKEN.

The application of the various methods is discussed in the accompanying text.

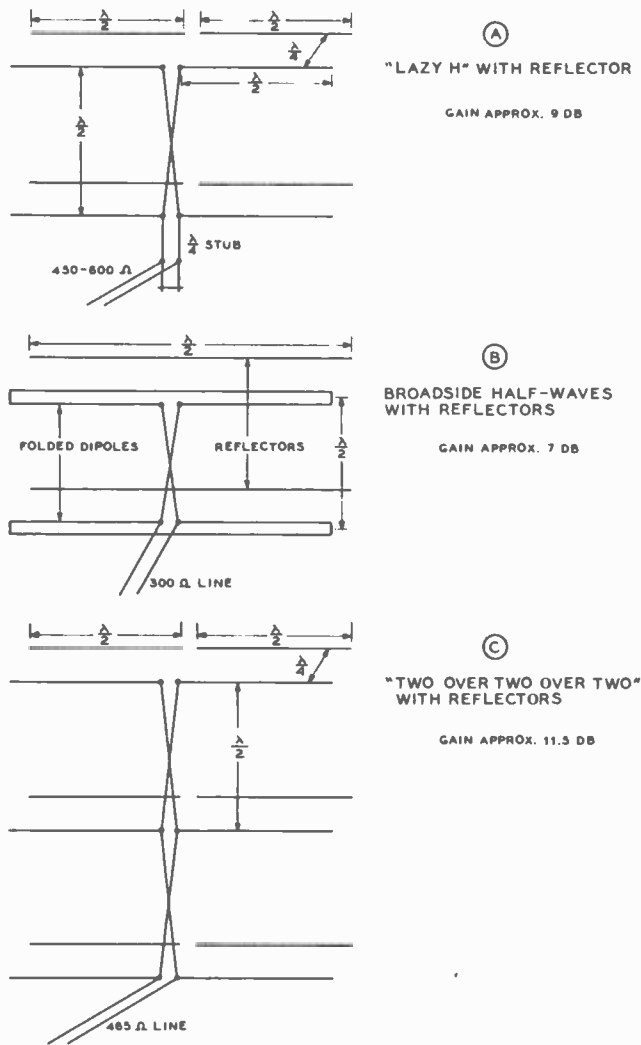

Figure 6.

UNIDIRECTIONAL BROADSIDE ARRAYS.

Reflectors have been placed behind each of the driven elements to obtain a unidirectional radiation characteristic.

feeding an array with a broken driven element from an open-wire line with the aid of a quarter-wave matching transformer. With 465-ohm line from the transmitter to the antenna this system will give a close match to a 12-ohm impedance at the center of the driven element. (C) shows an arrangement which uses an untuned transformer with lumped inductance for matching the transmission line to the center impedance of the driven element.

Rotary Link Coupling In many cases it is desirable to be able to allow the antenna array to rotate continuously without regard to snarling of the feed line. If this is to be done some sort of slip rings or rotary joint must be made in the feed line. One relatively simple method of allowing unrestrained rotation of the antenna is to use the method of rotary link coupling shown in Figure 5D. The two coupling rings are 10 inches in diameter and are usually constructed of 1/4-inch copper tubing supported one from the rotating structure and one from the fixed structure by means of standoff insulators. The capacitor C in Figure 5D is adjusted, after the antenna has been tuned, for minimum standing-wave ratio on the antenna transmission line. The dimensions shown will allow operation with either a 14-Mc. or 28-Mc. array, with appropriate adjustment of the capacitor C. The rings must of

course be parallel and must lie in a plane normal to the axis of rotation of the rotating structure.

30-3 Unidirectional Stacked Broadside Arrays

Three practicable types of unidirectional stacked broadside arrays are shown in Figure 6. The first type, shown at Figure 6A, is the simple "lazy H" type of antenna with reflectors for each element. (B) shows a simpler antenna array with a pair of folded dipoles spaced one-half wave vertically, operating with reflectors. In Figure 6C is shown a more complex array with six half waves and six reflectors which will give a very worthwhile amount of gain.

In all three of the antenna arrays shown the spacing between the driven elements and the reflectors has been shown as one-quarter wavelength. This has been done to eliminate the requirement for tuning of the reflector, as a result of the fact that a half-wave element spaced exactly one-quarter wave from a driven element will make a unidirectional array when both elements are the same length. Using this procedure will give a gain of 3 db with the reflectors over the gain without the reflectors, with only a moderate decrease in the radiation resistance of the driven element. Actually, the radiation resistance of a half-wave dipole goes down from 73 ohms to 60 ohms when an identical half-wave element is placed one-quarter wave behind it.

A very slight increase in gain for the entire array (about 1 db) may be obtained at the expense of lowered radiation resistance, the necessity for tuning the reflectors, and decreased bandwidth by placing the reflectors 0.15 wavelength behind the driven elements and making them somewhat longer than the

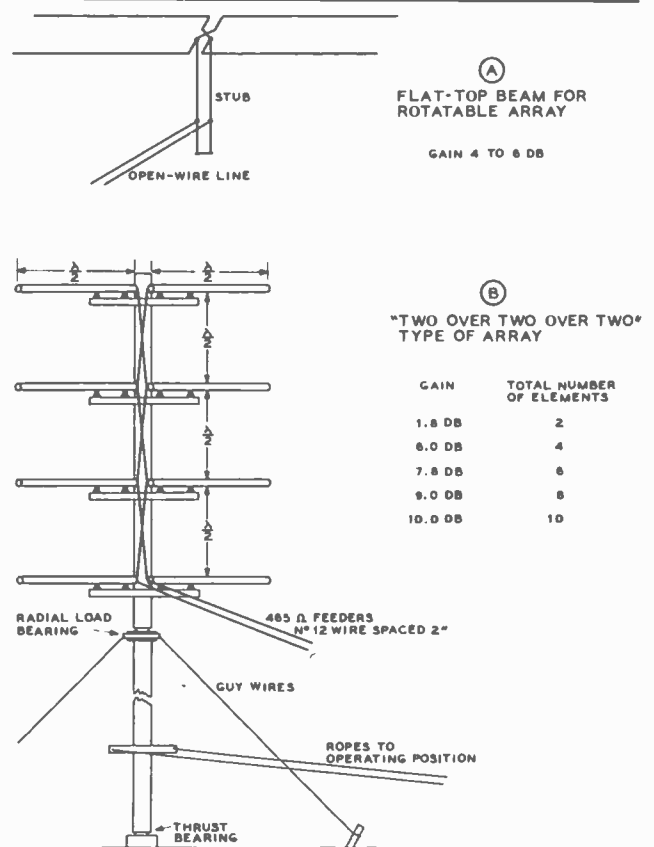

Figure 7.

TWO GENERAL TYPES OF BI-DIRECTIONAL ARRAYS.

Average gain figures are given for both the flat-top beam type of array and for the broadside-colinear array with varying numbers of elements.

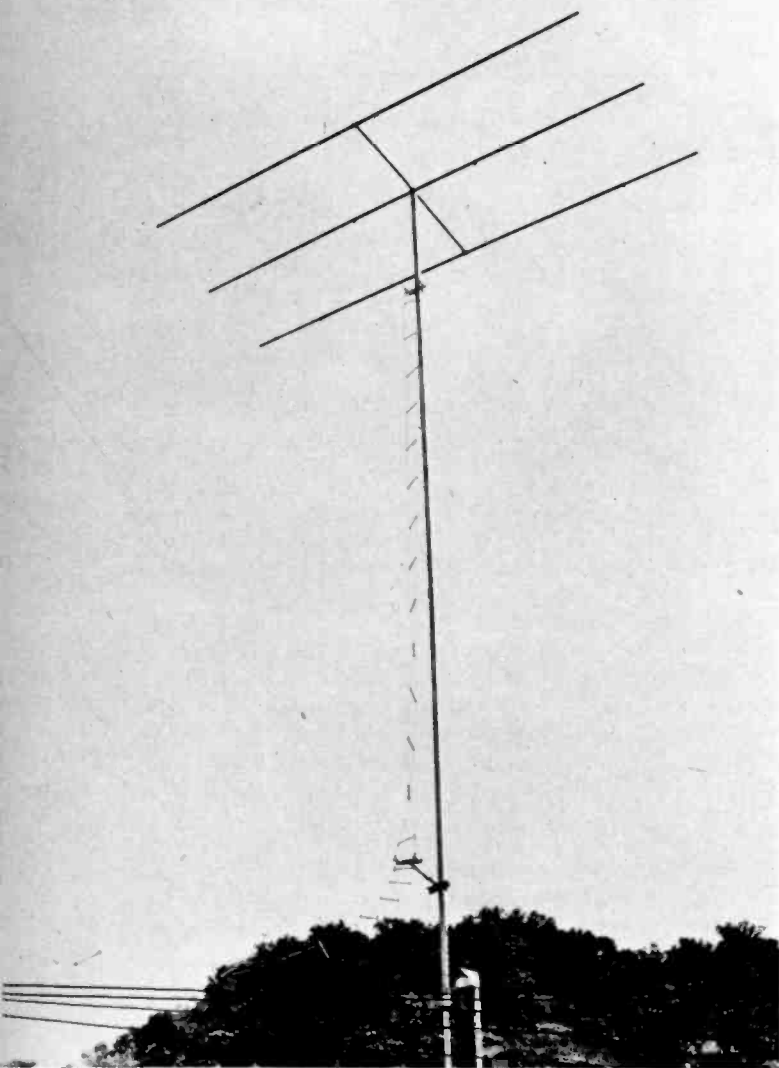

Figure 8.
AN EXAMPLE OF THE "PLUMBER'S DELIGHT" ARRAY
FOR 28-MC.

A sketch giving dimensions of this array is given in Figure 16 of Chapter 12.

driven elements. The radiation resistance of each element will drop approximately to one-half the value obtained with untuned half-wave reflectors spaced one-quarter wave behind the driven elements.

Antenna arrays of the type shown in Figure 6 require the use of some sort of lattice work for the supporting structure since the arrays occupy appreciable distance in space in all three planes.

Feed Methods The requirements for the feed systems for antenna arrays of the type shown in Figure 6 are much less critical than those for the close-spaced parasitic arrays shown in the previous section. This is a natural result of the fact that a larger number of the radiating elements are directly fed with energy, and of the fact that the effective radiation resistance of each of the driven elements of the array is much higher than the feed-point resistance of a parasitic array. As a consequence of this fact, arrays of the type shown in Figure 6 can be expected to cover a somewhat greater frequency band for a specified value of standing-wave ratio than the parasitic type of array.

In most cases a simple open-wire line may be coupled to the feed point of the array without any matching system. The standing-wave ratio with such a system of feed will often be less than 2-to-1. However, if a more accurate match between the antenna transmission line and the array is desired a con-

ventional quarter-wave stub, or a quarter-wave matching transformer of appropriate impedance, may be used to obtain a low standing-wave ratio.

30-4 Bi-Directional Rotatable Arrays

The bi-directional type of array is most satisfactory on the 28-Mc. and 50-Mc. bands where signals are likely to be coming from only one general direction at a time. Hence the sacrifice of discrimination against signals arriving from the opposite direction is likely to be of little disadvantage. Figure 7 shows two general types of bi-directional arrays. The flat-top beam, which has been described in detail in Chapter 28, is well adapted to installation atop a rotating structure. When self-supporting elements are used in the flat-top beam the problem of losses due to insulators at the ends of the elements is somewhat reduced. With a single-section flat-top beam gains of approximately 4 db can be expected, and with two sections a gain of approximately 6 db can be obtained.

Another type of bi-directional array which has seen less use than it deserves is shown in Figure 7B. This type of antenna system has a relatively broad azimuth or horizontal beam, being capable of receiving signals with little diminution in strength over approximately 40°, but it has a quite sharp elevation pattern since substantially all radiation is concentrated at the lower angles of radiation if more than a total of four elements is used in the antenna system. Figure 7B gives the approximate gain over a half-wave dipole at the height of the center of the array which can be expected. Also shown in this figure is a type of "rotating mast" structure which is well suited to rotation of this type of array.

If six or more elements are used in the type of array shown in Figure 7B no matching section will be required between the antenna transmission line and the feed point of the antenna. When only four elements are used the antenna is the familiar "lazy H" and a quarter-wave stub should be used for feeding from the antenna transmission line to the feed point of the antenna system.

If desired, and if mechanical considerations permit, the gain of the arrays shown in Figure 7B may be increased by 3 to 4 db by placing a half-wave reflector behind each of the elements at a spacing of one-quarter wave. The array then becomes essentially the same as that shown in Figure 6C and the same considerations in regard to reflector spacing and tuning will apply. However, the factor that a bi-directional array need be rotated through an angle of less than 180° should be considered in this connection.

30-5 Construction of Rotatable Arrays

A considerable amount of ingenuity may be exercised in the construction of the supporting structure for a rotatable array. Every person has his own ideas as to the best method of construction. Often the most practicable method of construction will be dictated by the availability of certain types of constructional materials. But in any event be sure that sound mechanical engineering principles are used in the design of the supporting structure. There are few things quite as discouraging as the picking up of the pieces, repairing of the roof, etc., when a newly constructed rotary comes down in the first strong wind. If the principles of mechanical engineering are understood it is wise to calculate the loads and torques which will exist in the various members of the structure with the highest wind velocity which may be expected in the locality of the installation. If this is not possible it will usually be worth the time and effort to look up a friend who understands these principles; an aerodynamicist or an aircraft structure designer will be a good bet.

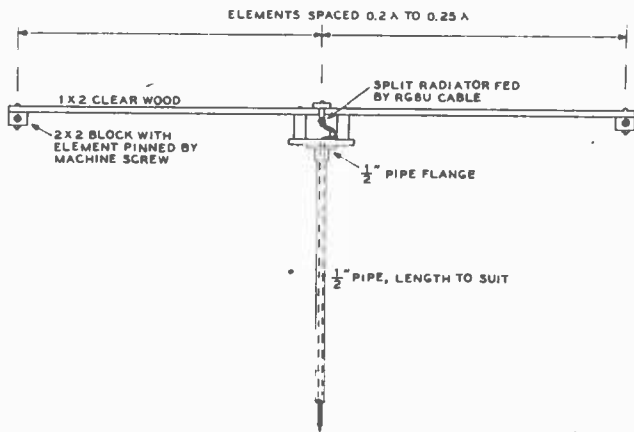

Figure 9.
DRAWING OF A SIMPLE 3-ELEMENT ARRAY FOR
50-Mc. OPERATION.

Radiating Elements One thing more or less standard about the construction of rotatable antenna arrays is the use of dural tubing for the self-supporting elements. Other materials may be used but an alloy known as 24ST has proven over a period of time to be most satisfactory. Copper tubing is far too heavy for a given strength, and steel tubing, unless copper plated, is likely to add an undesirably large loss resistance to the array. Also, steel tubing, even when plated, is not likely to withstand salt atmosphere such as encountered along the seashore for a satisfactory period of time. Do not use a soft aluminum alloy for the elements; 24ST is a hard alloy and is best although there are several other alloys ending in "ST" which will be found to be satisfactory. Do not use an alloy ending in "SO" or "S" in a position in the array where structural strength is important, since these letters designate a metal which has not been heat treated for strength and rigidity. However, these softer alloys, and aluminum electrical conduit, may be used for short radiating elements such as would be used for the 50-Mc. band or as interconnecting conductors in a stacked array.

"Plumber's Delight" Construction It is characteristic of the conventional type of multi-element parasitic array such as discussed previously and outlined in Figure 2 that the centers of all the elements are at zero r-f potential with respect to ground. Hence it is possible to use a metallic structure without insulators for supporting the various elements of the array. A 28-Mc. three-element array of this type is shown in Figure 8. Mechanical information on the construction of this particular array is given in Chapter 12 Figure 16. In this particular array pipe-fitting "T's" have been used at either end to support the 1-inch dural tubing reflector and director, with pieces of standard water pipe as spacers on either side between the parasitic elements and the driven element. The fitting at the center of the structure was made especially for the purpose, with threads at the bottom for the steel pipe which supports the entire structure, threads on two sides for receiving the two pieces of 1-inch water pipe which support the reflector and director, and another hole at right angles through which the driven element is passed. The parasitic elements are held fast in the T's at either end by splitting the top of the T the long way and running a bolt through the T and the dural element at each end of the T. The center element is held in position in the center piece by means of two bolts tapped into the center piece which are tightened down against the driven element.

The center piece in this particular array was turned from a large piece of rod and later drilled and tapped. A somewhat less expensive center piece of adequate strength could be constructed by welding an appropriate flange to the bottom of a steel plate, welding a piece of pipe to the top to hold the driven element, and welding either two pieces of pipe, or fittings to receive them, for the two members which support the parasitic elements.

A piece of hardened steel drill rod such as used in oil-well construction was used as the rotating-mast support for the array shown in Figure 8. The rotating mast is supported a little more than half way up by a radial-load bearing attached to a telephone pole, and a heavy thrust bearing is used at the bottom.

The Simple Girder Supporting Structure In many cases when metal-working tools are not available a relatively simple supporting structure made of wood is used to hold the radiating elements. Figures 9, 10, 11, 12, and 13 show photographs and constructional details for two 50-Mc. arrays in which a single piece of wood is used to hold the radiating elements. The main problem in constructing this type of a structure is to make sure that the holes through the supporting member are drilled true. If the holes are out of alignment the completed array is likely to have a somewhat haphazard appearance, although its operation probably will not be impaired. The array shown in Figures 9 and 10 is a very simple affair which may be constructed in a relatively short period of time.

Figure 10.
PHOTOGRAPH OF THE ARRAY OF FIGURE 9.

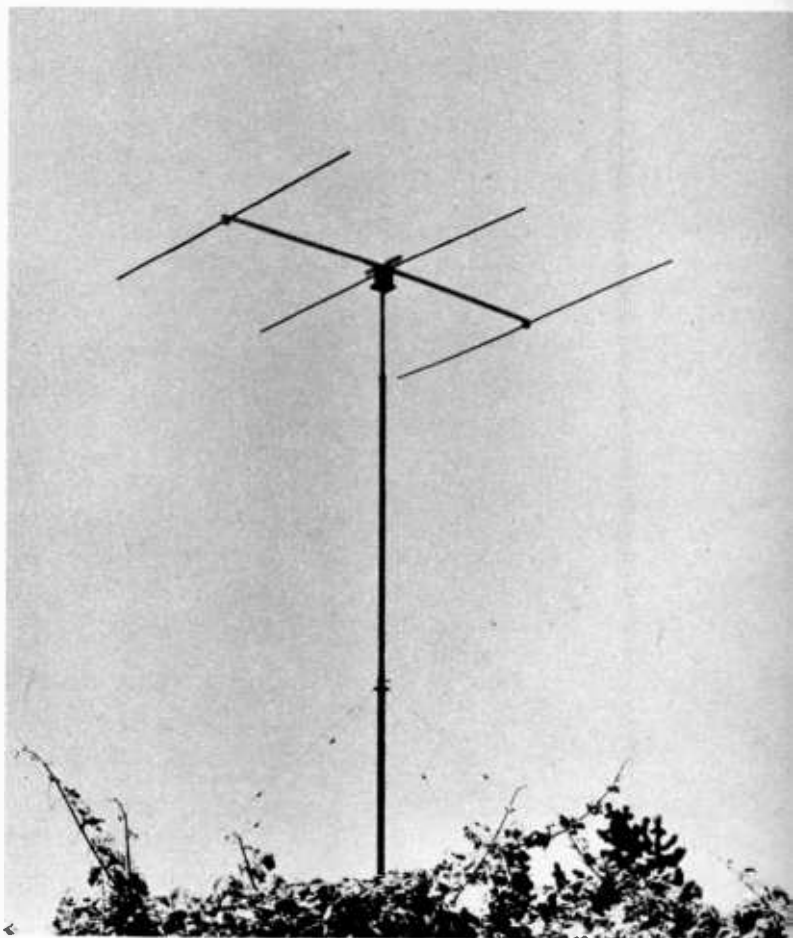

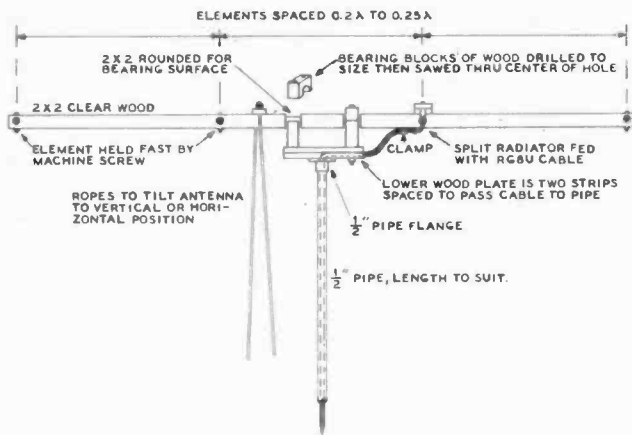

Figure 11.
DRAWING OF A "TIPPABLE" 4-ELEMENT ARRAY
FOR THE 50-MC. BAND

The antenna array shown in Figures 11, 12, and 13 is an answer to the problem of providing both horizontally-polarized and vertically-polarized operation with the same directive array. The supporting structure is constructed so as to be capable of rotation in a plane perpendicular to the axis of the member so that the elements may be either horizontal or vertical. A pair of ropes attached to a bridle bolted to the supporting member make it possible to change the polarization of the array without changing the direction of radiation.

Figure 14 is a drawing of a relatively simple three-element vertically-polarized array for the 50-Mc. band. The basis of the array is a "hypodermic" or sleeve-type dipole radiator. This array, as well as those shown in Figures 9 and 11, is directly fed at the center of the driven element by means of 52-ohm coaxial cable. A satisfactory impedance match to an open-wire line can be obtained through the use of one of the matching systems shown in Figure 3.

Although a very simple wood structure can be used to support the elements of a 50-Mc. array, a somewhat more rigid structure must be used as the main boom in a 28-Mc. or

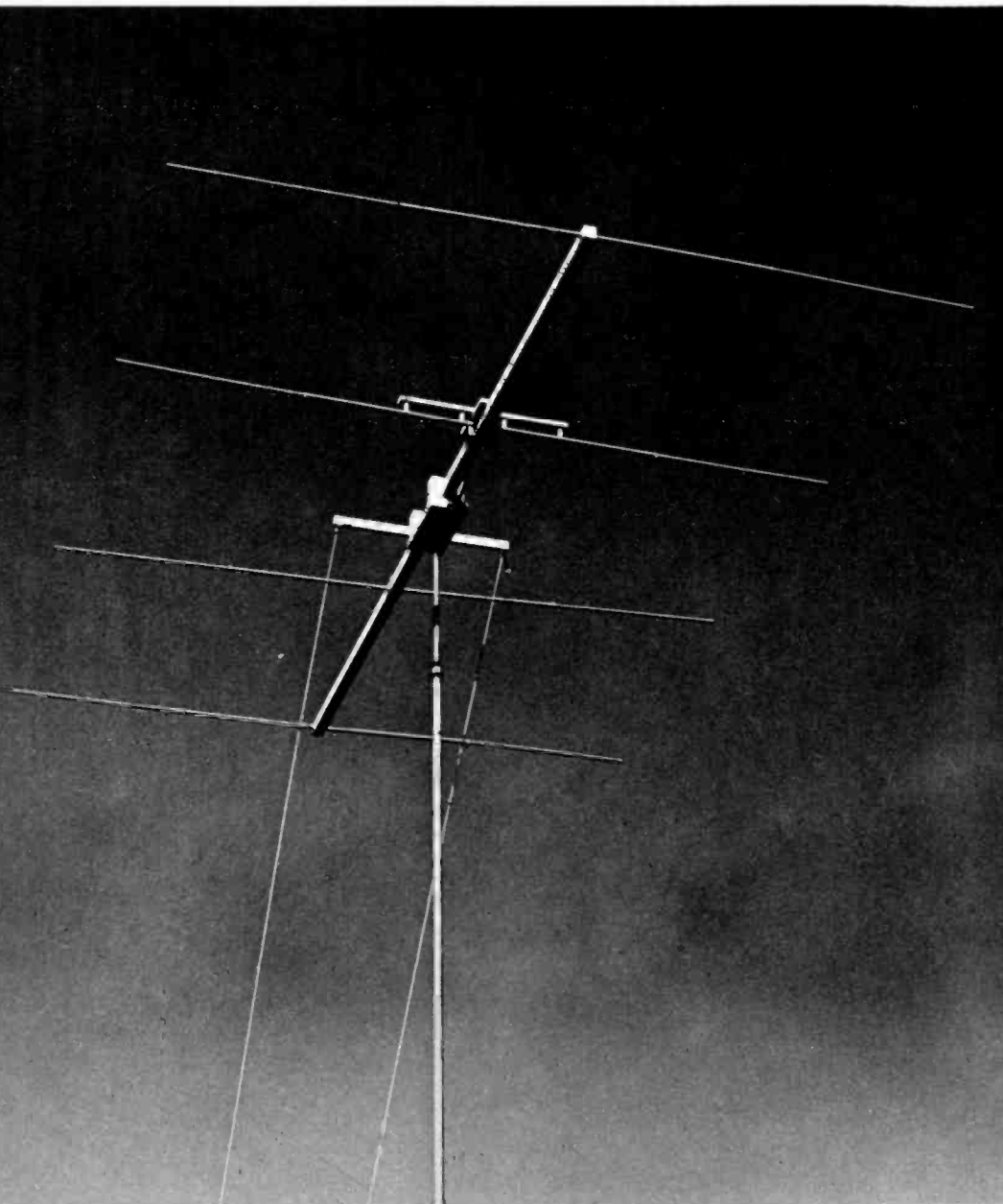

Figure 12.
"TIPPABLE" ARRAY IN THE
HORIZONTAL POSITION.

14-Mc. antenna. Figure 15 shows two commonly used types of center main boom for a larger array such as is required on the lower-frequency bands. Figure 15A shows a metal-boom type of construction which is quite satisfactory for construction of a plumber's delight type of structure. If the rectangular type of tubing is available it will be found somewhat easier to manage than the round dural tubing, but both types are relatively simple to use in making such a structure. For anchoring the radiating elements to the dural boom either a set of collars on either side of the boom may be used, or bolts may be run through both the boom and the elements. Any of the shunt feeding systems shown in Figure 3 or Figure 4 may be used to feed an array of this type.

A conventional ladder makes a satisfactory supporting boom for an array in the general manner illustrated in Figure 15B. Ladders are relatively inexpensive, and produce a strong and stable type of mounting platform. The ladder, and for that matter any type of wood supporting structure, should be given several coats of a good grade of outside paint to protect it from the elements.

Supporting structures for more complex arrays involving elements in several planes may effectively be constructed of lattice work. Main members should be constructed of well-seasoned pieces of straight lumber. The angular braces may well be made of light relatively strong pieces such as redwood $\frac{3}{8}$ " by $1\frac{1}{4}$ " "battens." The entire structure should be both glued (using a waterproof glue) and bolted into place.

30-6 Tuning Up the Array

Although many arrays may be constructed, installed, and operated with substantially no tuning process, there is always some doubt in the mind of the operator as to whether or not the array is delivering optimum results. So most operators make a check on the operation of the array before calling the job complete.

The process of tuning up an array may fairly satisfactorily be divided into two more or less distinct steps: the actual tuning of the array for best front-to-back ratio or for maximum forward gain, and the project of obtaining the best possible impedance match between the antenna transmission line and the feed point of the array.

Tuning the Array Proper The actual tuning of the array for best front-to-back ratio or maximum forward gain may best be accomplished with the aid of a low-power transmitter feeding a dipole antenna (polarized the same as the array being tuned) at least four or five wavelengths away from the antenna being tuned. A calibrated field-strength meter of the remote-indicating type such as described in Chapter 31 is then coupled to the feed point of the antenna array being tuned. The transmissions from the portable transmitter should be made as short as possible and the call sign of the station making the test should be transmitted at least every ten minutes.

It is, of course, possible to tune an array with the receiver connected to it and with a station a mile or two away making transmissions on your request. But this method is more cumbersome and is not likely to give complete satisfaction. It is also possible to carry out the tuning process with the transmitter connected to the array and with the field-strength meter connected to the remote dipole antenna. In this event the indicating instrument of the remote-indicating field-strength meter should be visible from the position where the elements are being tuned. However, when the array is being tuned with the transmitter connected to it there is always the problem of making continual adjustments to the transmitter so that a constant amount of power will be fed to the array under test.

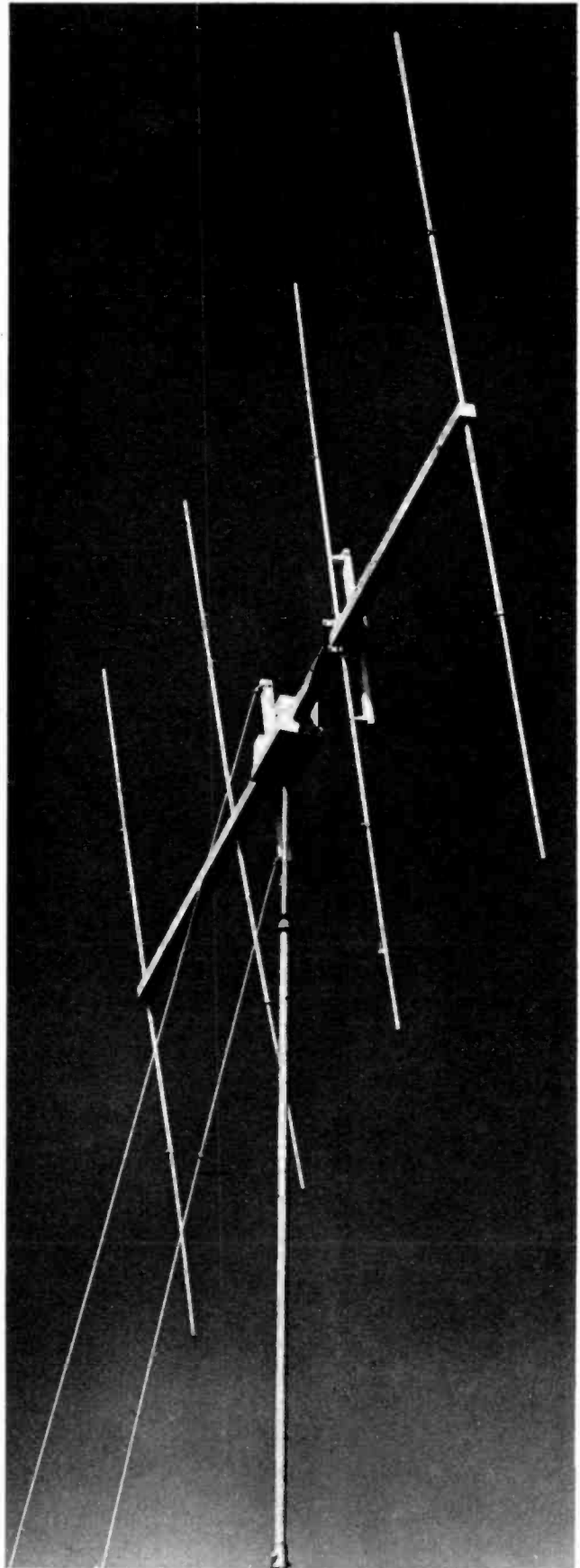

Figure 13.
THE "TIPPABLE" ARRAY ORIENTED FOR VERTICAL POLARIZATION.

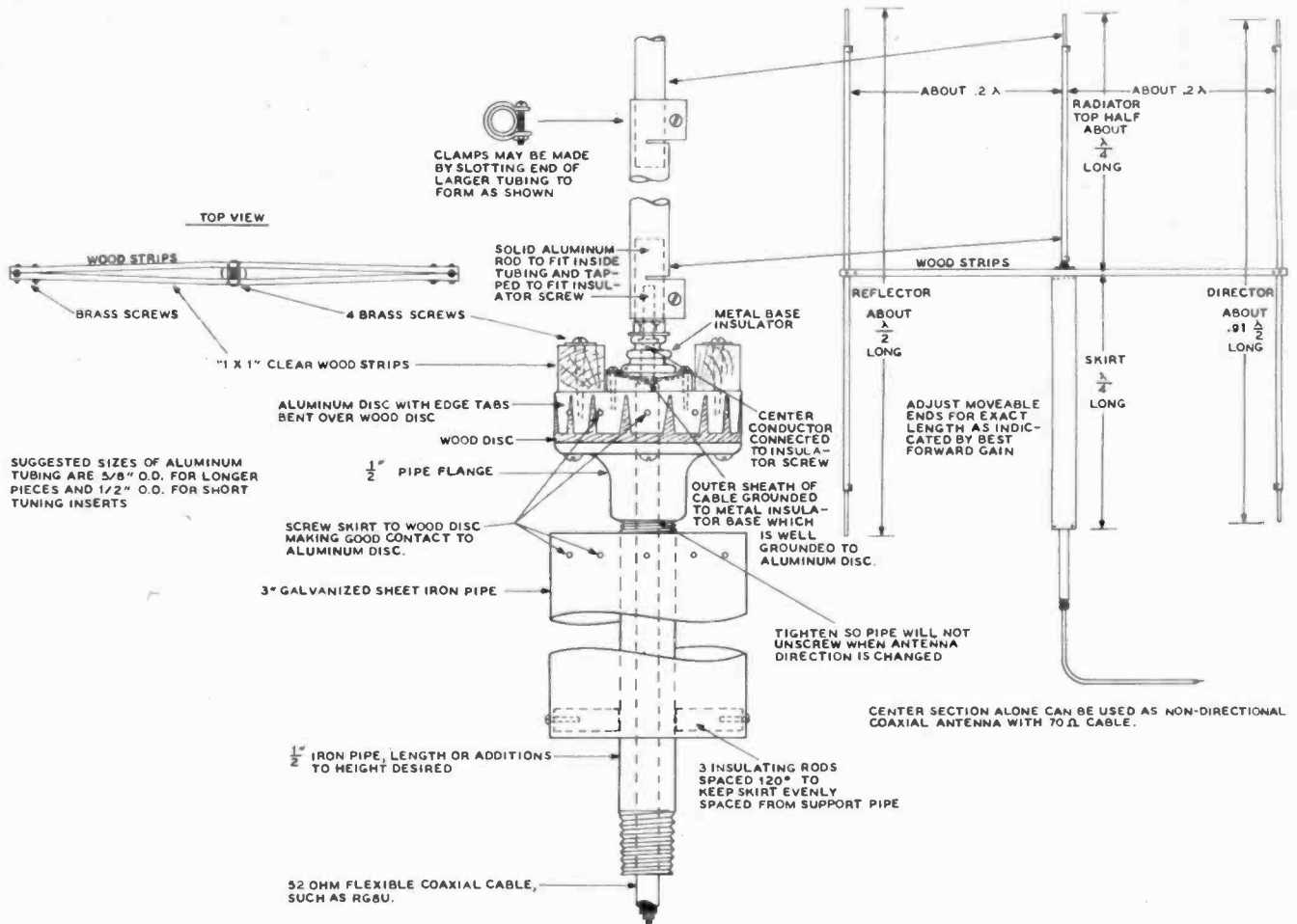

Figure 14.

DRAWING OF A 3-ELEMENT VERTICAL ARRAY.

This antenna is designed for vertical polarization only. Three-inch galvanized "downspout" or gutter pipe is used for the vertical sleeve because it fits snugly over a standard 1/2" flange plate. A scaled-down version for 144-Mc. operation could be installed quite high on the end of a piece of 1/2-inch water pipe. Be sure to use pipe compound in screw joints and pull the joint up tight.

Also, if you use this system, use very low power (a watt or two is usually sufficient) and make sure that the antenna transmission line is effectively grounded as far as d-c plate voltage is concerned. The use of the method described in the previous paragraph of course eliminates these problems.

One satisfactory method for tuning the array proper, assuming that it is a system with several parasitic elements, is to set the directors to the dimensions given in Figure 2 and then to adjust the reflector for maximum forward signal. Then the first director should be varied in length until maximum forward signal is obtained, and so on if additional directors are used. Then the array may be reversed in direction and the reflector adjusted for best front-to-back ratio. Subsequent small adjustments may then be made in both the directors and the reflector for best forward signal with a reasonable ratio of front-to-back signal. The adjustments in the directors and the reflector will be found to be interdependent to a certain degree, but if small adjustments are made after the preliminary tuning process a satisfactory set of adjustments for maximum performance will be obtained. It is usually best to make the end sections of the elements smaller in diameter so that they will slip inside the larger tubing sections. The smaller sliding sections may be clamped inside the larger main sections by the method shown in Figure 16.

In making the adjustments described, it is best to have the rectifying element of the remote-indicating field-strength

meter directly at the feed point of the array, with a resistor at the feed point of the estimated value of feed-point impedance for the array. This procedure is described in connection with the f-s meter in Chapter 31.

Matching to the Antenna Transmission Line

The problem of matching the impedance of the antenna transmission line to the array is much simplified if the process of tuning the array is made a substantially separate process as just described. The antenna transmission line, with the calculated value of impedance-matching transformer or network between the line and antenna feed point, is then attached to the array and coupled to the transmitter. Then, if available, a standing-wave meter is connected in series with the antenna transmission line at a point relatively much more close to the transmitter than to the antenna. However, for best indication there should be 10 to 15 feet of line between the transmitter and the standing-wave meter. If a standing-wave meter is not available the standing-wave ratio may be checked approximately by means of a neon lamp or a short fluorescent tube if twin transmission line is being used, or it may be checked with a thermomilliammeter and a loop, a neon lamp, or an r-f ammeter and a pair of clips spaced a fixed distance for clipping onto one wire of a two-wire open line.

If the standing-wave ratio is below 2 or 3 it is satisfactory

to leave the installation as it is. If the ratio is greater than this range it will be best when twin line is being used, and advisable with open-wire line, to attempt to decrease the s.w.r.

The condition of the match may be checked in the following manner: measure the current in one leg of the feeder starting directly at the point where the antenna transmission line connects to the antenna (or antenna matching system such as the delta, "T," or yoke) and check the current values as you proceed toward the transmitter. If the current *increases* as you proceed away from the antenna the feed-point impedance is *higher* than that of the transmission line. If the current *decreases* as you proceed toward the transmitter the feed-point impedance is *lower* than the characteristic impedance of the transmission line. The ratio of the current maximum to the current minimum should be noted as the standing-wave ratio *r*.

Since the points of minimum current can be found with more accuracy than the points of maximum current, measure the distance from the antenna end of the feed line to the first current minimum. If this distance is one-half wavelength the feed line is operating into a pure resistance of *r* times the characteristic impedance of the feed line; in other words, the load impedance which the transmission line "sees" is resistive, meaning that the antenna is resonant, and is greater than the characteristic impedance of the transmission line by the value of the standing-wave ratio. If the distance to the first minimum is one-quarter wavelength the antenna is also resonant and is presenting a resistive load to the line but the value of this resistance is equal to the characteristic impedance of the trans-

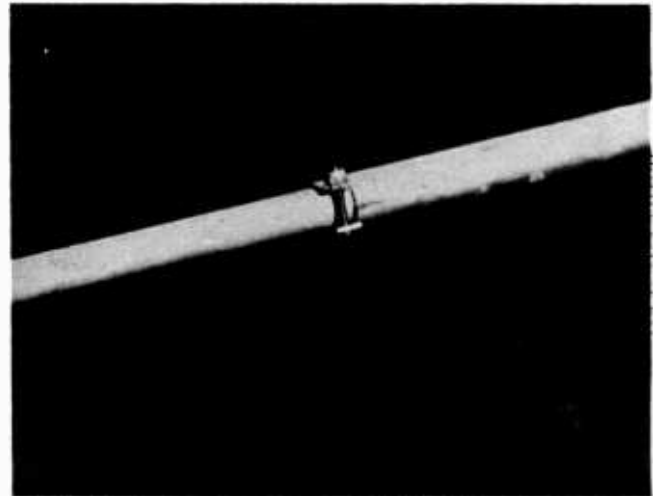

Figure 16.

CLAMPING METHOD FOR ADJUSTABLE ELEMENTS.

The larger of the two elements is sawed on one side for about one-half inch, and then at the end of the saw slot the tubing is sawed crosswise about one-half through. The ears thus formed are bent out, drilled, and a 6-32 screw with a locking nut is run through the holes to clamp the larger element to the smaller.

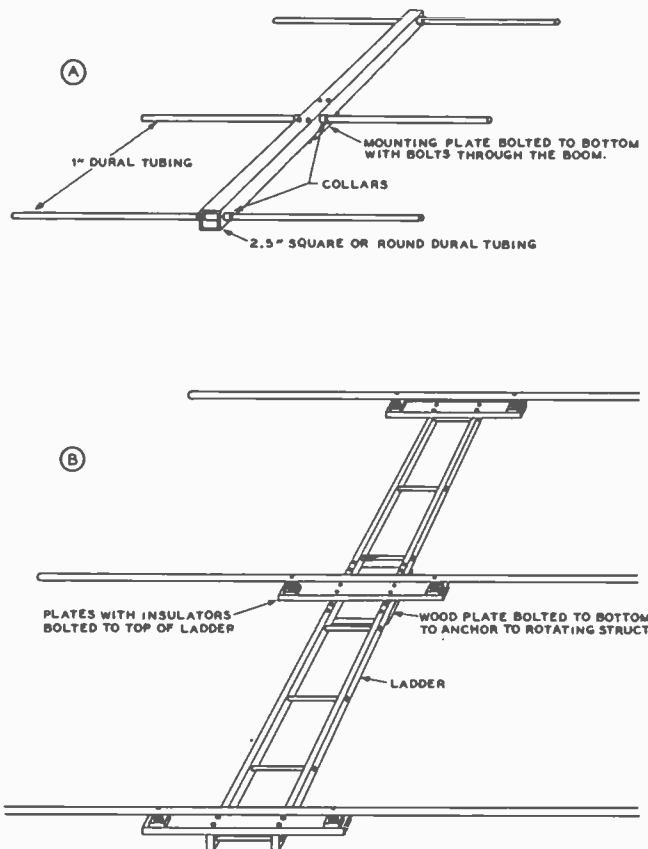

Figure 15.

ALTERNATIVE ARRAY SUPPORTING BOOM ARRANGEMENTS.

(A) shows the use of a section of dural tubing (either rectangular or round cross section) for supporting a moderate-size array. At (B) is shown the use of a ladder for supporting a relatively large array.

mission line *divided* by *r* (the s.w.r. on the line). If the distance from the antenna end of the transmission line to the first current minimum is any value other than 1/2 wave or 1/4 wave the antenna system is presenting a reactive load to the antenna transmission line; treatment of this condition will be given in a following paragraph.

Assuming that the antenna system is presenting a resistive load of the wrong value to the antenna feed line, and assuming also that all adjustments have been made on the delta match, "T" match, yoke match, or folded-element match in an effort to obtain the lowest possible value of standing-wave ratio, the easiest procedure for obtaining an accurate impedance match is to insert a quarter-wave transformer into the feed line. The feed line should be cut at a point of current *maximum*; the points of current maximum are of course 1/4 wave in either direction from the more easily measured points of current minimum. If the current minimum is one-quarter wave from the antenna the current maximum will be directly at the point where the feed line connects to the antenna system. If the current *minimum* is one-half wave from the end of the transmission line the feeder should be cut *one-quarter* wave from the antenna since this will be a point of current maximum. A quarter-wave section of transmission line should then be inserted at this point. The impedance of this quarter-wave section should be equal to the geometric mean between the characteristic impedance of the main feed line and the impedance that the feed line is "seeing" at the point where it was cut. However, the required impedance for the feed line can also be determined very easily from the standing-wave ratio *r* and the characteristic impedance of the main antenna feed line *Z₀*. The expression for determining the proper value of impedance for the quarter-wave section, *Z_q*, is as follows:

$$Z_q = \sqrt{\frac{Z_0^2}{r}}$$

To take an example, suppose a 465-ohm line constructed of no. 12 wire on 2" feeder spreaders is being used to feed a rotary affair with "T" match. The first current minimum on the feed line came just one-quarter wave from the "T" and the standing-wave ratio of current measured on the line was found to be 4-to-1. The proper impedance of the quarter-wave section *Z_q* would then be:

$$Z_0 = \sqrt{\frac{(465)^2}{4}} = \sqrt{54,056} = 232 \text{ ohms}$$

Since the first current minimum came one-quarter wave from the "T," the first current maximum is right at the "T" so the 465-ohm feed line should be removed from the "T" and a quarter-wave section of 232-ohm transmission line inserted. This line may be made up in the same manner as a set of "Q" bars with 1/2-inch aluminum tubing spaced 1 3/4", or a four-wire line, as described in Chapter 12, may be made up with four no. 14 wires equally spaced around a 3.44" circle; the spacing between wires on the corners would be 2-7/16 inches.

Matching When the Feed Point is Reactive If the antenna is presenting a reactive load to the transmission line at its feed point, an attempt should first be made to make the antenna perfectly resonant. This will probably involve a slight adjustment in the length of the driven element in a parasitic array, or a change in the dimensions of all the driven elements in a stacked array. If the reactance cannot be eliminated the antenna system may still be made to present a resistive load to the transmission line in the following manner: Measure the standing-wave ratio r as before. Locate the current *maximum* on the feed line which is closest to the antenna. As before the current maximums will be located one-quarter wave from the current minimums, and when the approximate location of the current maximum has been found, determine accurately the location of the closest current minimum and measure one-quarter wave from the minimum to obtain the accurate location of the current maximum. Cut the main antenna transmission line at the point of this current *maximum*, and insert a quarter-wave section of transmission

line having a characteristic impedance determined in the same manner from the Z_0 of the main transmission line and the s.w.r. r as discussed in the previous paragraph. In other words, the antenna system is presenting a pure resistive load at a point of current maximum on the main feed line so we can use the same procedure, with this point as reference, as was discussed in the previous paragraph.

Matching with Feeder other than Open-Wire Line The problem of matching the feed line to the antenna is simplest when using open-wire line. When twin line is being used it is sometimes possible to obtain a satisfactory indication of the relative current values in the line through the use of a flat loop of wire about 6" long attached to a thermomilliammeter, with the straight part of the loop placed on the side of the twin line directly alongside one of the conductors. A relative indication may be obtained through the use of a fluorescent tube placed against the flat of the line. In this case the length of the glow will be approximately equal to the voltage between the two conductors making up the line.

When coaxial cable is being used as feed line on the v-h-f and u-h-f bands a slotted line may be used to measure standing-wave ratio and the position of the current maxima and minima. But the use of a slotted line is impracticable due to the size required on frequencies below perhaps 144 Mc.

Standing-wave meters may be used with coaxial line, twin line, or open-wire line. These instruments are very satisfactory for determining the magnitude of the s.w.r., but they do not indicate the position of the current maximums and minimums on the line. Sometimes a s-w-r meter may be used in conjunction with a fluorescent tube in the tuning process with ribbon-

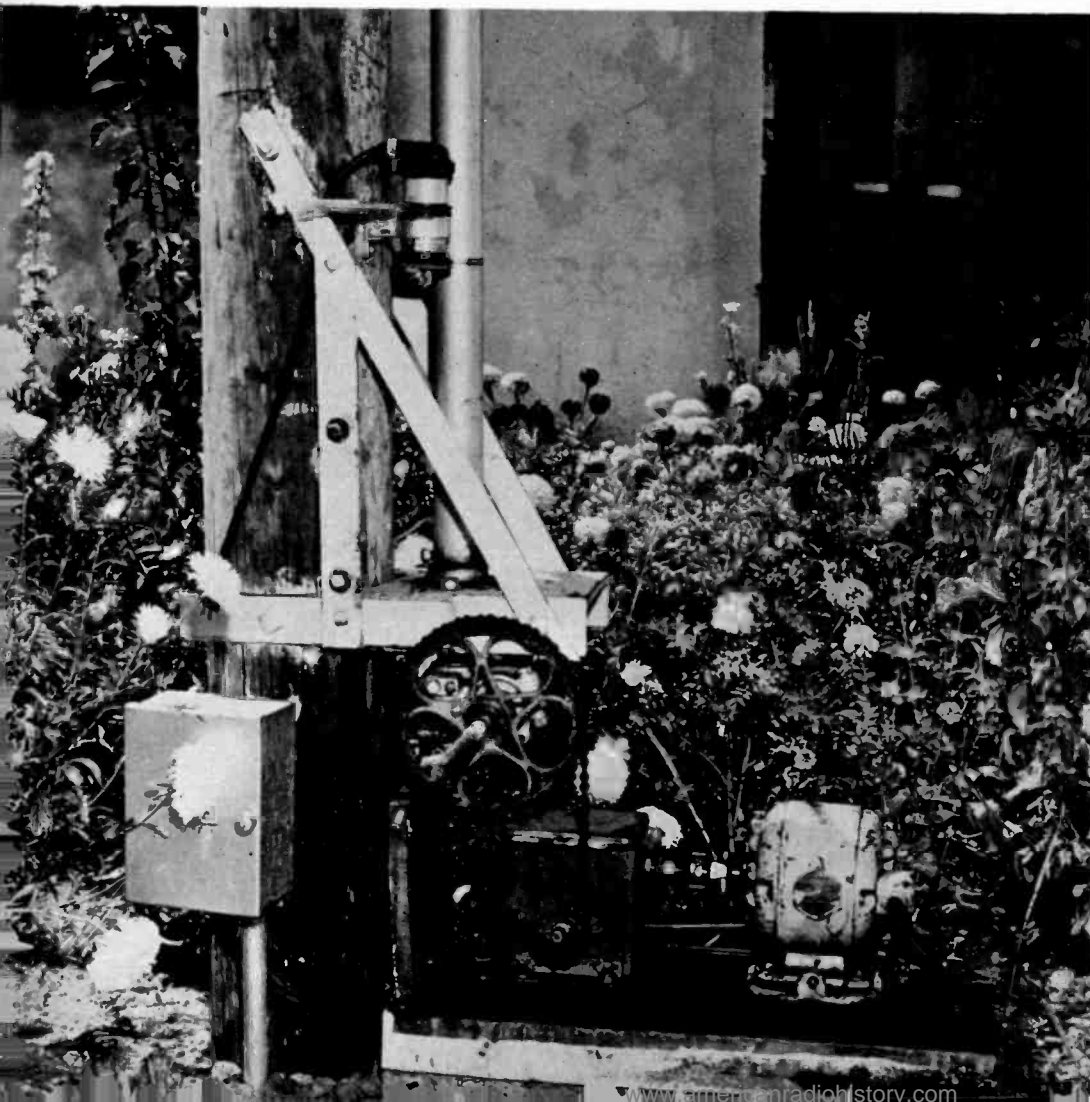

Figure 17.
AN INSTALLATION OF A
ROTATABLE MAST.

The rotatable mast is supported at the bottom and part way up by bearings attached to a telephone pole. The drive motor and the indicating synchro are located at the bottom of the rotating mast.

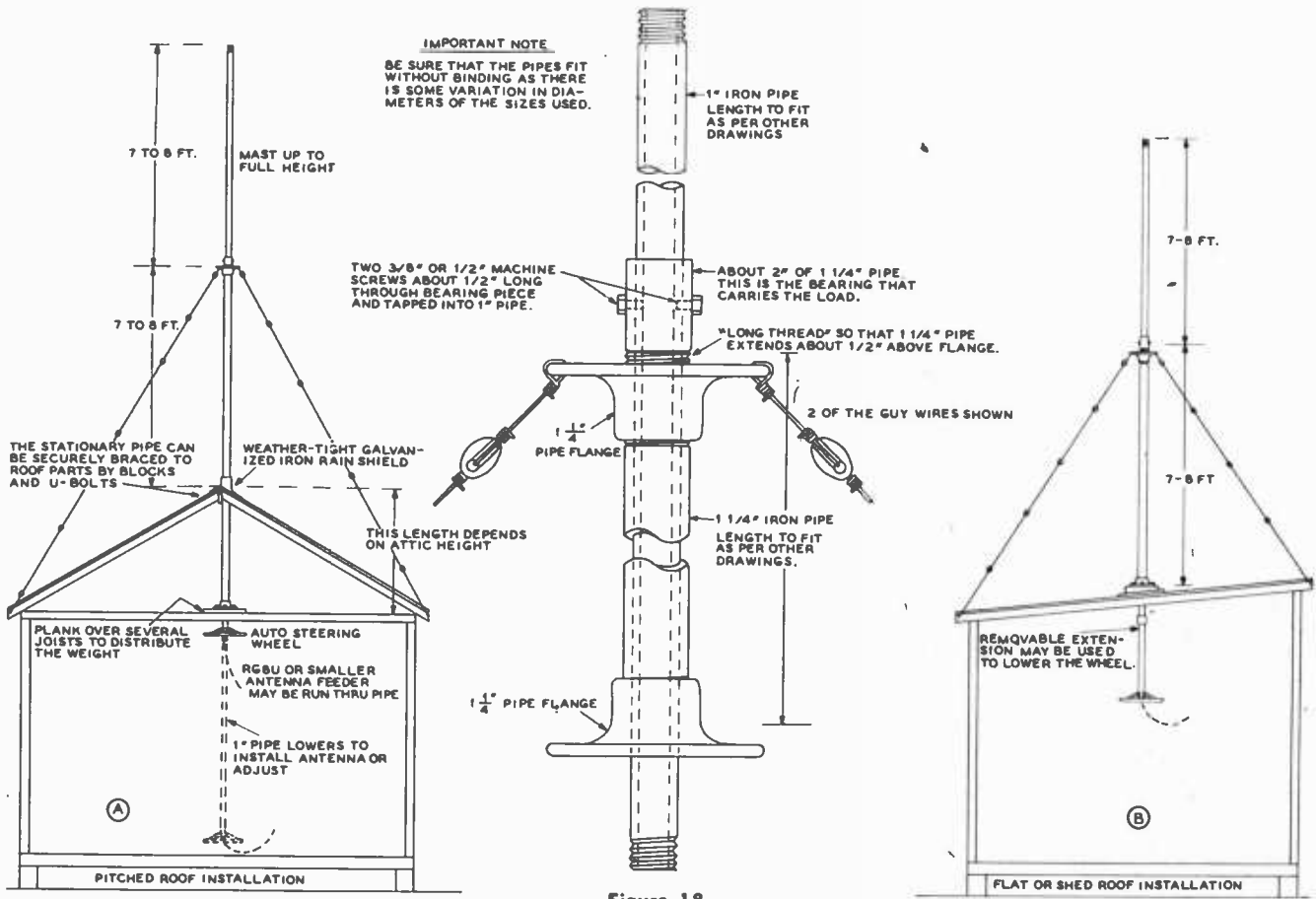

Figure 18. ALL-PIPE ROTATING-MAST STRUCTURE FOR ROOF INSTALLATION.

An installation suitable for a building with a pitched roof is shown at (A). At (B) is shown a similar installation for a flat or shed roof. The arrangement as shown is strong enough to support a lightweight 3-element 28-Mc. array. It should be possible to stack a light 3-element 50-Mc. array above the 28-Mc. array without additional support on the end of a 6 or 8 foot length of 1/2-inch pipe.

The lengths of pipe shown were chosen so that when the system is in the lowered position one can stand on a household ladder and put the beam in position atop the rotating pipe. The lengths may safely be revised upward somewhat if the array is of a particularly lightweight design with low wind resistance. The several types of antennas shown in this chapter with pipe flange mounting provision all have been used with this type of mast and rotating structure.

Just before the mast is installed it is a good idea to give the rotating pipe a good smearing of cup grease or waterproof pump grease. To get the lip of the top of the stationary section of 1 1/4-inch pipe to project above the flange plate, it will be necessary to have a plumbing shop cut a slightly deeper thread inside the flange plate, as well as cutting an unusually long thread on the end of the 1 1/4-inch pipe. It is relatively easy to waterproof this assembly through the roof since the 1 1/4-inch pipe is stationary at all times. Be sure to use pipe compound on all the joints and then really tighten these joints with a pair of pipe wrenches.

type line. The fluorescent tube will indicate the position of the voltage maxima and minima and the s-w-r meter will give the magnitude of the s.w.r. on the line, thus giving all the information necessary to obtain an accurate match between the antenna system and the transmission line.

Raising and Lowering the Array A practical problem always present when tuning up and matching an array is the physical location of the structure.

If the array is atop the mast it is inaccessible for adjustment, and if it is located on step-ladders where it can be adjusted easily it cannot be rotated. One encouraging factor in this situation is the fact that experience has shown that if the array is placed 6 or 8 feet above ground on some step-ladders for the preliminary tuning process, the raising of the system to its full height will not produce a serious change in the adjustments. So it is usually possible to make preliminary adjustments with the system located slightly greater than head height above ground, and then to raise the antenna to a position where it may be rotated for final adjustments. If the position of the sliding sections as determined near the ground is marked

so that the adjustments will not be lost, the array may be raised to rotatable height and the fastening clamps left loose enough so that the elements may be slid in by means of a long bamboo pole. After a series of trials a satisfactory set of lengths can be obtained. But the end results usually come so close to the figures given in Figure 2 that a subsequent array is usually cut to the dimensions given and installed as is.

The matching process does not require rotation, but it does require that the antenna proper be located at as nearly its normal operating position as possible. However, on a particular installation the positions of the current minimums on the transmission line near the transmitter may be checked with the array in the air, and then the array may be lowered to ascertain whether or not the positions of these points have moved. If they have not, and in most cases if the feeder line is strung out back and forth well above ground as the antenna is lowered they will not change, the positions of the last few toward the antenna itself may be determined. Then the calculation of the matching quarter-wave section may be made, the section installed, the standing-wave ratio again checked, and the antenna re-installed in its final location.

30-7 Systems For Obtaining Rotation

Structures for the rotation of antenna arrays may be subdivided into two general classes: the rotating mast and the rotating platform. The rotating-mast type of structure is probably the most satisfactory arrangement for a home constructed system. An example of a home-built arrangement is shown in the photograph of Figure 17. This is the rotating arrangement for the antenna shown in Figure 8 of this chapter. The mast is rotated by means of a reversible 115-volt a-c motor through a reduction system. A small selsyn motor is driven by the mast through dial cord and an indicating selsyn with a pointer is installed at the operating position to show the position of the antenna.

The rotating-platform system is probably best if the rotating device is to be purchased. A number of excellent rotating platform devices are available on the market for varying prices. The larger and more expensive rotating devices are suitable for the rotation of a rather sizeable array for the 14-Mc. band while the smaller structures are designed for less load and should be used only with a 28-Mc. or 50-Mc. array. Most common practice is to install the rotating device atop a platform built at the top of a telephone pole or on the top of a lattice mast of sizeable cross section so that the mast will be self-supporting and capable of withstanding the torque imposed upon it by the rotating platform.

Turning the Rotating Structure If the rotating-mast type of structure is used it is a relatively simple process to work out a drive method. If the rotating mast comes down through the top of the radio shack as does the mast of the antenna system shown in Figure 10 a very satisfactory arrangement is merely to install a large steering wheel on the bottom of the rotating mast, with the thrust bearing for the structure located above the roof. This system is sketched in Figure 18. In the example shown a piece of 1 1/4-inch pipe is fixed permanently to the roof of the shack and the rotary array is mounted on a piece of 1-inch pipe which comes down into the shack through the larger diameter pipe. In the particular installation shown in Figure 18 the antenna itself is fed by means of a length of 52-ohm RG-8/U cable which is threaded down inside the piece of pipe which is rotated.

If the rotating mast is located a reasonable distance from the operating position a system of pulleys and ropes may be used to drive the antenna. Of course the most satisfactory drive system is that which uses an electric motor, but a moderate amount of ingenuity is required to obtain all the reduction gearing system for electric motor drive.

A system which is widely used for driving rotatable antennas for radar work uses a *servomechanism* for accomplishing the actual rotation of the antenna. In this type of system a small *synchro* (or *selsyn*) motor (5G for example) is coupled to a

handwheel and an indicator dial. The output of the control synchro is coupled to another synchro of special design (5CT for example) in the base of the pedestal or rotating structure of the antenna in such a manner that any error between the relative position of the two synchros is coupled into an electronic device called a servoamplifier. The output of the servoamplifier system is then fed to a motor in the base of the pedestal of the antenna. The polarity and strength of the energy fed from the servoamplifier to the driving motor are such that the motor will turn the rotating structure until the synchro (which is geared to the rotating platform) is in the same relative position as the rotor of the synchro which is geared to the handwheel. This type of drive for a rotatable antenna is ideal since only the slightest force on the handwheel is adequate to position even the largest rotatable antenna to the exact direction indicated by the pointer on the driving synchro. However, such systems are complex and expensive. Nevertheless a number of the components for such a driving system are available on the surplus market and may be adapted to the job of driving an amateur rotatable array.

Indication of Direction The most satisfactory method for indicating the direction of transmission of a rotatable array is that which uses selsyns or synchros for the transmission of the data from the rotating structure to the indicating pointer at the operating position. A number of synchros and selsyns of various types are available on the surplus market. Some of them are designed for operation on 115 volts at 60 cycles, some are designed for operation on 60 cycles but at a lowered voltage, and some are designed for operation from 400-cycle or 800-cycle energy. This latter type of high-frequency selsyn is the most generally available type, and the high-frequency units are smaller and lighter than the 60-cycle units. Since the indicating synchro must deliver an almost negligible amount of power to the pointer which it drives, the high-frequency types will operate quite satisfactorily from 60-cycle power if the voltage on them is reduced to somewhere between 6.3 and 20 volts. In the case of many of the units available, a connection sheet is provided along with a recommendation in regard to the operating voltage when they are run on 60 cycles. In any event the operating voltage should be held as low as it may be and still give satisfactory transmission of data from the antenna to the operating position. Certainly it should not be necessary to run such a voltage on the units that they become overheated.

Systems using a potentiometer capable of continuous rotation and a milliammeter, along with a battery or other source of direct current, may also be used for the indication of direction. A commercially-available potentiometer (Ohmite RB-2) may be used in conjunction with a 0-1 d-c milliammeter having a hand-calibrated scale for direction indication.

Test and Measurement Equipment

EVERY amateur station is required by law to have certain essential pieces of test equipment. A c-w station is required to have a frequency meter or other means of insuring that the transmitter is within one of the frequency bands assigned to amateurs. A radiophone station is required in addition to have a means of determining that the transmitter is not being modulated in excess of its modulation capability. Further, any station operating with an input greater than 900 watts is required to have a means of determining the exact input to the final stage of the transmitter.

The additional test and measurement equipment required by a station will be determined by the type of operation contemplated. It is always desirable that a station have an accurately calibrated volt-ohmmeter for routine transmitter and receiver checking and as an assistance in getting new pieces of equipment into operation. An oscilloscope and an audio oscillator make a very desirable adjunct to a phone station and a calibrated signal generator is almost a necessity if much receiver work is contemplated. A field-strength meter and standing-wave meter are also almost a necessity if extensive antenna work is to be done.

On the other hand the measurement equipment used by a testing or research laboratory must be much more versatile in its capabilities. Any sort of problem may be encountered in the testing or alignment of a transmitter, receiver, amplifier, or antenna system. So the equipment must be capable and accurate enough to make the desired tests within the specified limits of accuracy.

The test and measurement equipment to be described in this chapter may be divided into four general classifications: Voltage, Current, and Power Measurement; Measurement of Circuit Constants; Frequency Measurements; and Monitoring Equipment.

31-1 Voltage, Current and Power

The measurement of voltage and current in radio circuits is very important in proper maintenance of equipment. Vacuum tubes of the types used in communications work must be operated within rather narrow limits in regard to filament or heater voltage, and they must be operated within certain maximum limits in regard to the voltage and current on other electrodes.

Both direct current and voltage are most commonly measured with the aid of an instrument consisting of a coil that is free to rotate in a constant magnetic field (d'Arsonval type instrument). If the instrument is to be used for the measurement of current it is called an ammeter or milliammeter. The current flowing through the circuit is caused to flow through the moving coil of this type of instrument. If the current to be measured is greater than 10 milliamperes or so it is the usual practice to cause the majority of the current to flow through a by-pass resistor called a shunt, only a specified portion of the current flowing through the moving coil of the instrument. The calculation of shunts for extending the range of d-c milliammeters and ammeters is discussed in Chapter Two.

A direct current voltmeter is merely a d-c milliammeter with a multiplier resistor in series with it. If it is desired to use a low-range milliammeter as a voltmeter the value of the multiplier resistor for any voltage range may be determined from the following formula:

$$R = \frac{1000 E}{I}$$

where: R = multiplier resistor in ohms
E = desired full scale voltage
I = full scale current of meter in ma.

The sensitivity of a voltmeter is commonly expressed in *ohms per volt*. The higher the ohms per volt of a voltmeter the greater its sensitivity. When the full-scale current drain of a voltmeter is known, its sensitivity rating in ohms per volt may be determined by:

$$\text{Ohms per volt} = \frac{1000}{I}$$

where I is the full-scale current drain of the indicating instrument in milliamperes.

Multi-Range Meters It is common practice to connect a group of multiplier resistors in the circuit with a single indicating instrument to obtain a so-called multi-range voltmeter. There are several ways of wiring such a meter, the most common ones of which are indicated in Figure 1. With all these methods of connection, the sensitivity of the meter in ohms per volt is the same on all scales. With

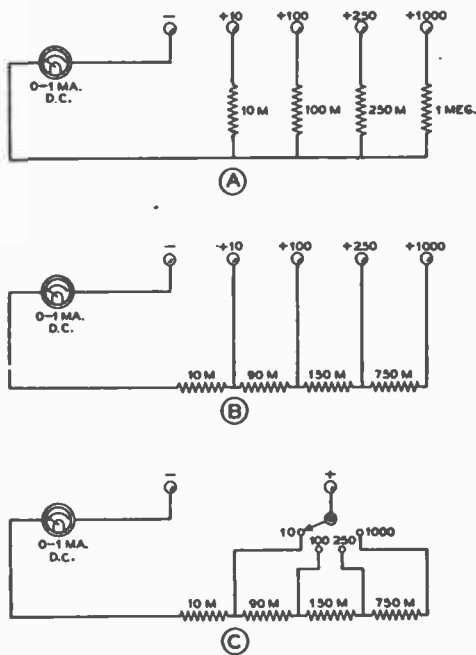

Figure 1.

THREE COMMON METHODS FOR WIRING A MULTI-VOLTMETER

(A) shows the method whereby individual multipliers are used for each range. (B) is the more economical "series multiplier" method. The same number of resistors is required but those for the higher range are of lower resistance (and hence less expensive when precision wirewound resistors are used) than at (A). (C) is essentially the same arrangement as at (B) but a range switch is used to select the different voltage ranges.

a 0-1 milliammeter as shown the sensitivity is 1000 ohms per volt.

Volt-Ohmmeters An extremely useful piece of test equipment which should be found in every laboratory or radio station is the so-called volt-ohmmeter. It consists of a multi-range voltmeter with an additional fixed resistor, a variable resistor, and a battery. A typical example of such an instrument is diagrammed in Figure 2. Tap 1 is used to permit use of the instrument as an 0-1 d-c milliammeter. Tap 2 permits accurate reading of resistors up to 100,000 ohms; taps 3, 4, 5, and 6 are for making voltage measurements, the full scale voltages being 10, 50, 250, and 500 volts respectively.

The 1000-ohm potentiometer is used to bring the needle to zero ohms when the terminals are shorted; this adjustment should always be made before a resistance measurement is taken. Higher voltages than 500 can be read if a higher value of multiplier resistor is added to an additional tap on the switch. The proper value for a given full scale reading can be determined from Ohm's law.

Resistances higher than 100,000 ohms cannot be measured accurately with the circuit constants shown; however, by increasing the ohmmeter battery to 45 volts and multiplying the 4000-ohm resistor and 1000-ohm potentiometer by 10, the ohms scale also will be multiplied by 10. This would permit accurate measurements up to 1 megohm.

0-1 d-c milliammeters are available with special volt-ohmmeter scales which make individual calibration unnecessary. Or, special scales can be purchased separately and substituted for the original scale on the milliammeter.

Obviously, the accuracy of the instrument either as a voltmeter or as an ammeter can be no better than the accuracy of the milliammeter and the resistors.

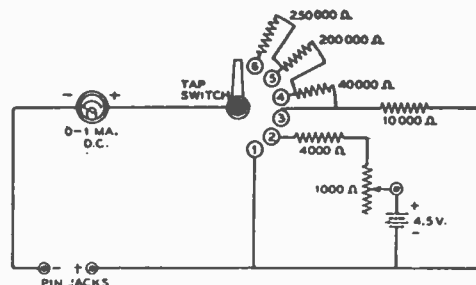

Figure 2.

VOLT-OHMMETER CIRCUIT

Position 1 of Switch.....	0-1 d-c ma.
Position 2 of Switch.....	0-100,000 ohms
Position 3 of Switch.....	0-10 volts
Position 4 of Switch.....	0-50 volts
Position 5 of Switch.....	0-250 volts
Position 6 of Switch.....	0-500 volts

Because volt-ohmmeters are so widely used and because the circuit is standardized to a considerable extent, it is possible to purchase a factory-built volt-ohmmeter for no more than the component parts would cost if purchased individually. For this reason no construction details are given. However, anyone already possessing a suitable milliammeter and desirous of incorporating it in a simple volt-ohmmeter should be able to build one from the schematic diagram and design data given here. Special, precision (accurately calibrated) multiplier resistors are available if a high degree of accuracy is desired.

Medium-and Low-Range Ohmmeter

Most ohmmeters, including the one just described, are not adapted for accurate measurement of low resistances—in the neighborhood of 100 ohms, for instance.

The ohmmeter diagrammed in Figure 3 was especially designed for the reasonably accurate reading of resistances all the way down to 1 ohm. Two scales are provided, one going in one direction and the other scale going in the other direction because of the different manner in which the milliammeter is used in each case. The low scale covers from 1 to 100 ohms and the high scale from 100 ohms to 10,000 ohms. The high scale is in reality a medium-range scale. For accurate reading of resistances over 10,000 ohms, an ohmmeter of the type previously described should be used.

The 1-100 ohm scale is useful for checking transformers, chokes, r-f coils, etc., which often have a resistance of only a few ohms.

The calibration scale will depend upon the internal resistance of the particular make of 1.5-ma. meter used. The instrument can be calibrated by means of a Wheatstone bridge or a few resistors of known accuracy. The latter can be series-connected and parallel-connected to give sufficient calibration points. A hand-drawn scale can be pasted over the regular meter scale to give a direct reading in ohms.

Before calibrating the instrument or using it, the test prods should always be touched together and the zero adjuster set accurately.

Measurement of Alternating Current and Voltage

The measurement of alternating current and voltage is complicated by two factors: first, the frequency range covered in ordinary communication channels

is so great that calibration of an instrument becomes extremely difficult; second, there is no single type of instrument which is suitable for all a-c measurements—as the d'Arsonval type of movement is suitable for d.c. The d'Arsonval movement will not operate on a.c. since it indicates the

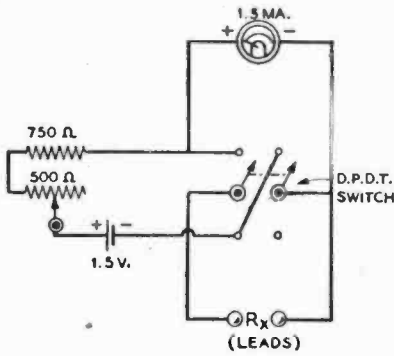

Figure 3. SCHEMATIC DIAGRAM OF THE LOW-RANGE OHMMETER.

average value of current flow, and the average value of an a-c wave is zero.

As a result of the inability of the reliable d'Arsonval type of movement to record an alternating current, either this current must be rectified and then fed to the movement, or a special type of movement which will operate from the effective value of the current can be used.

For the usual measurements of power frequency a-c (25-60 cycles) the familiar iron-vane instrument is commonly used. For audio frequency a.c. (50-20,000 cycles) a d'Arsonval instrument having an integral copper oxide or selenium rectifier is usually used. Radio frequency voltage measurements are usually made with some type of a vacuum-tube voltmeter, while r-f current measurements are almost invariably made with an instrument containing a thermo-couple to convert the r.f. into d.c. for the movement.

Since an alternating current wave can have an almost infinite variety of shapes, it can easily be seen that the ratios between the three fundamental quantities of the wave (peak, r.m.s or effective, and average after rectification) can also vary widely. So it becomes necessary to know beforehand just which quality of the wave under measurement our instrument is going to indicate. For the purpose of simplicity we can list the usual types of a-c meters in a table along with the characteristic of an a-c wave which they will indicate:

Iron-vane, thermocouple	R.m.s.
Rectifier (CuO) type	Average after rect.
V.t.v.m.	Peak, r.m.s., or average depending upon the design of the instrument.

Vacuum-Tube Voltmeters A vacuum-tube voltmeter is essentially a detector in which a change in the signal placed upon the input will produce a change in the indicating instrument (usually a d'Arsonval meter) placed in the output circuit. A vacuum-tube voltmeter may use a diode, a triode, or a multi-element tube, and it may be used either for the measurement of a.c. or d.c.

When a v.t.v.m. is used in d-c measurement it is used for this purpose primarily because of the very great input resist-

ance of the device. This means that a v.t.v.m. may be used for the measurement of a-v-c, a-f-c, and discriminator output voltages where no loading of the circuit can be tolerated. A simple battery-operated v.t.v.m. circuit for making this type of d-c measurement is diagrammed in Figure 4. Due to the degeneration introduced by the cathode resistor the calibration of this instrument will be comparatively linear. For the measurement of negative voltages such as appear on an a-v-c line, the terminal marked + should be grounded and the one marked - should be connected to the bus. For the measurement of discriminator voltages (where the voltage may be either positive or negative with respect to the axis) 10 or 15 volts of positive bias may be placed in series with the test prod, making the voltmeter essentially a zero-center device.

A-C V-T Voltmeters There are many different types of a-c vacuum-tube voltmeters, all of which operate as some type of a rectifier to give an indication on a d-c instrument (usually a d'Arsonval movement). There are two general types: those which give an indication of the r-m-s value of the wave (or approximately this value of a complex wave), and those which give an indication of the peak or crest value of the wave.

The voltmeter diagrammed in Figure 4 can be considered as being representative also of the type of vacuum-tube voltmeter used for giving an r-m-s indication of the wave being measured. This circuit is very little affected by the shape of the wave under measurement, so it can be used for measurement of complex wave shapes. The unit as shown will have a full-scale range of about 20 volts. If a greater range than this is desired, both the supply voltage and the cathode resistor may be multiplied by the same factor. In any case the maximum voltage which can be measured will be slightly less than the supply voltage to the plate of the tube.

Since the setting up and calibration of a wide-range vacuum-tube voltmeter is rather tedious, in most cases it will be best to purchase a commercially manufactured unit. Several excellent commercial units are on the market at the present time. These feature a wide range of a-c and d-c voltage scales at high sensitivity, and in addition several feature a built-in vacuum-tube ohmmeter which will give indications up to 500 or 1000 megohms. However, for applications where the versatility of the manufactured units is not necessary, an adaption of the circuit shown in Figure 4, perhaps with a tube such as a 7A4 and a power supply for a-c operation, will give excellent results after the calibration chart has been made.

Peak A-C V-T Voltmeters There are two common types of peak-indicating vacuum-tube voltmeters. The first is the so-called "slide-back" type in which a simple v.t.v.m. such as shown in Figure 4 is used along with a conventional d-c voltmeter and a source of "bucking" bias in

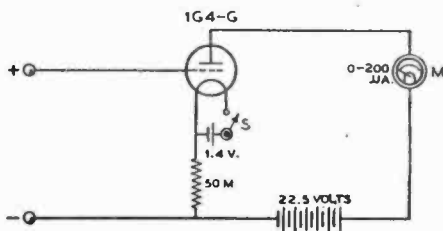

Figure 4. SIMPLE A-C OR D-C V-T VOLTMETER
An instrument of this type is suitable for a-v-c, a-f-c, and discriminator output voltage measurements. It may also be used as an a-c voltmeter.

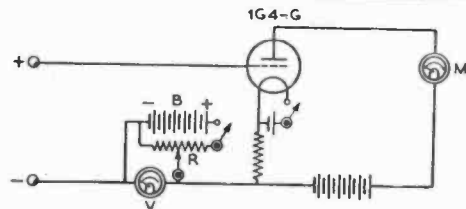

Figure 5. SIMPLE SLIDE-BACK VOLTMETER.
By connecting a variable source of voltage in series with the input to the simple meter shown in Figure 4, a slide-back a-c voltmeter for peak voltage measurements is made. The resistor R should be about 1000 ohms per volt at battery B.

series with the input. With this type of an arrangement (Figure 5) leads are connected to the voltage to be measured and the slider resistor R across the "bucking" voltage is backed down until an indication on the meter (called a false zero) equal to that value given with the prods shorted and the bucking voltage reduced to zero is obtained. Then the value of the bucking voltage (read on V) is equal to the peak value of the voltage under measurement. The slide-back voltmeter has the disadvantage that it is not instantaneous in its indication—adjustments must be made for every voltage measurement. For this reason the slide-back v.t.v.m. is not commonly used, being supplanted by the diode-rectifier type of peak v.t.v.m. for most applications.

High-Voltage Diode Peak Voltmeter A diode vacuum-tube voltmeter suitable for the measurement of high values of a-c voltage is diagrammed in Figure 6. With the constants shown, the voltmeter has two ranges: 500 and 1500 volts *peak* full scale.

Capacitors C_1 and C_2 should be able to withstand a voltage in excess of the highest peak voltage to be measured. Likewise, R_1 and R_2 should be able to withstand the same amount of voltage. The easiest and least expensive way of obtaining such resistors is to use several low-voltage resistors in series, as shown in Figure 6. Other voltage ranges can be obtained by changing the value of these resistors, but for voltages less than several hundred volts a more linear calibration can be obtained by using a receiving-type diode. A calibration curve should be run to eliminate the appreciable error due to the high internal resistance of the diode, preventing the capacitor from charging to the full peak value of the voltage being measured.

A direct reading diode peak voltmeter of the type shown in Figure 6 will load the source of voltage by approximately *one-half* the value of the load resistance in the circuit (R_1 , or R_1 plus R_2 , in this case). Also, the peak voltage reading on the meter will be slightly less than the actual peak voltage being measured. The amount of lowering of the reading is determined by the ratio of the storage capacitance to the load resistance. If a cathode-ray oscilloscope is placed across the terminals of the v.t.v.m. when a voltage is being measured, the actual amount of the lowering in voltage may be determined by inspection of the trace on the c-r tube screen. The peak positive excursion of the wave will be slightly flattened by the action of the v.t.v.m. Usually this flattening will be so small as to be negligible. But if it is desired to compensate for the flattening in the wave the following procedure may be gone through: Measure the distance from the center of the c-r tube trace to the flattened crest with the v.t.v.m. connected. Disconnect the v.t.v.m. and measure again this distance. Multiply the ratio of the two distances (slightly larger than 1.0) by the voltage as read on the v.t.v.m. This procedure will give the actual crest value of the wave.

Measurement of Power Audio frequency or radio frequency power in a resistive circuit is most commonly and most easily determined by the indirect method, i.e., through the use of one of the following formulas:

$$P = EI \quad P = E^2/R \quad P = I^2R$$

These three formulas mean that if any two of the three factors determining power are known (resistance, current, voltage) the power being dissipated may be determined. In an ordinary 120-volt a-c line circuit the above formulas are not strictly true since the power factor of the line must be multiplied into the result—or a direct method of determining power such as a wattmeter may be used. But in a resistive a-f circuit and in a resonant r-f circuit the power factor of the energy is taken as being unity.

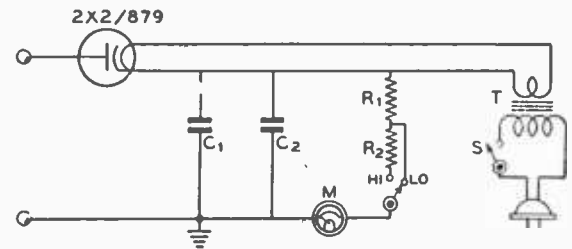

Figure 6.
WIRING DIAGRAM OF HIGH-VOLTAGE
PEAK VOLTMETER

- | | |
|---|--|
| C_1 —0.01- μ fd. high-voltage mica | T—2.5 v., 1.75 a. filament transformer |
| C_2 —1.0- μ fd. high-voltage paper | M—0-1 d-c milliammeter |
| R_1 —500,000 ohms (2 0.25-megohm $\frac{1}{2}$ -watt in series) | S_{HI-LO} —S-p-d-t toggle switch |
| R_2 —1.0 megohm (4 0.25-megohm $\frac{1}{2}$ -watt in series) | S—S-p-s-t toggle switch |

(Note: C_1 is a by-pass around C_2 , the inductive reactance of which may be appreciable at high frequencies.)

For accurate measurement of a-f and r-f power, a thermogalvanometer or thermocoupled ammeter in series with a non-inductive resistor of known resistance can be used. The meter should have good accuracy, and the exact value of resistance should be known with accuracy. Suitable dummy load resistors of the "vacuum" type are available in various resistances in both 100- and 250-watt ratings. These are virtually non-inductive, and may be considered as a pure resistance except at ultra-high frequencies. The resistance of these units is substantially constant for all values of current up to the maximum dissipation rating, but where extreme accuracy is required, a correction chart of the dissipation coefficient of resistance (supplied by the manufacturer) may be employed. This chart shows the exact resistance for different values of current through the resistor.

Sine-wave power measurements (r-f or single-frequency audio) may also be made through the use of a v.t.v.m. and a resistor of known value. In fact a v.t.v.m. of the type shown in Figure 6 is particularly suited to this work. The formula, $P = E^2/R$ is used in this case. However, it must be remembered that a v.t.v.m. of the type shown in Figure 6 indicates the *peak* value of the a-c wave. This reading must be converted to the r-m-s or *heating* value of the wave by multiplying it by 0.707 before substituting the voltage value in the formula. The same result can be obtained by using the formula $P = E^2/2R$.

The use of all three methods of determining power: ammeter-resistor, voltmeter-resistor, and voltmeter-ammeter, gives an excellent cross-check upon the accuracy of the determination and upon the accuracy of the *standards*.

Power may also be measured through the use of a calorimeter, by actually measuring the amount of heat being dissipated. Through the use of a water-cooled dummy load resistor this method of power output determination is being used by some of the most modern broadcast stations. But the method is too cumbersome for ordinary power determinations.

Power may also be determined photometrically through the use of a voltmeter, ammeter, incandescent lamp used as a load resistor, and a photographic exposure meter. With this method the exposure meter is used to determine the relative visual output of the lamp running as a dummy load resistor and of the lamp running from the 120-volt a-c line. A rheostat in series with the lead from the a-c line to the lamp is used to vary its light intensity to the same value (as indicated by the exposure meter) as it was putting out as a dummy load. The a-c voltmeter in parallel with the lamp and ammeter in series with it is then used to determine lamp power input by: $P = EI$. This method of power determination is satisfactory for

audio and low-frequency r.f. but is not satisfactory for u.h.f. because of variations in lamp efficiency due to uneven heating of the filament.

31-2 Measurement of Circuit Constants

The measurement of the resistance, capacitance, inductance, and Q (figure of merit) of the components used in communications work can be divided into three general methods: the impedance method, the substitution or resonance method, and the Wheatstone bridge method.

The Impedance Method The impedance method of measuring inductance and capacitance can be likened to the ohmmeter method for measuring resistance. An a-c voltmeter, or milliammeter in series with a resistor, is connected in series with the inductance or capacitance to be measured and the a-c line. The reading of the meter will be inversely proportional to the impedance of the component being measured. After the meter has been calibrated it will be possible to obtain the approximate value of the impedance directly from the scale of the meter. If the component is a capacitor, the value of impedance may be taken as its reactance at the measurement frequency and the capacitance determined accordingly. But the d-c resistance of an inductor must also be taken into consideration in determining its inductance. After the d-c resistance and the impedance have been determined, the reactance may be determined from the formula: $X_L = \sqrt{R^2 - Z^2}$. Then the inductance may be determined from: $L = X_L / 2\pi f$.

The Substitution Method The substitution or resonance method is perhaps the most satisfactory system for obtaining the inductance or capacitance of high-frequency components. A 500 to 1000 $\mu\mu\text{f}$. capacitor with a good dial having an accurate calibration curve is a necessity for making determinations by this method. If an unknown inductor is to be measured, it is connected in parallel with the standard capacitor and the combination tuned accurately to some known frequency. This tuning may be accomplished either by using the tuned circuit as a wavemeter and coupling it to the tuned circuit of a reference oscillator, or by using the tuned circuit in the controlling position of a two-terminal oscillator such as a dynatron or transitron. The capacitance required to tune this first frequency is then noted as C_1 . The circuit or the oscillator is then tuned to the *second harmonic* of this first frequency and the amount of capacitance again noted, this time as C_2 . Then the distributed capacitance across the coil (including all stray capacitances) is equal to: $C_0 = (C_1 - 4C_2) / 3$.

This value of distributed capacitance is then substituted in the following formula along with the value of the standard capacitance for either of the two frequencies of measurement:

$$L = \frac{1}{4\pi^2 f_1^2 (C_1 + C_0)}$$

The determination of an unknown capacitance is somewhat less complicated than the above. A tuned circuit including a coil, the unknown capacitor and the standard capacitor, all in parallel, is resonated to some convenient frequency. The capacitance of the standard capacitor is noted. Then the unknown capacitor is removed and the circuit re-resonated by means of the standard capacitor. The difference between the two readings of the standard capacitor is then equal to the capacitance of the unknown capacitor.

Another version of the procedure for determining an unknown capacitance is to use this capacitance as the tank capacitor in an oscillator. The signal put out by the oscillator is then

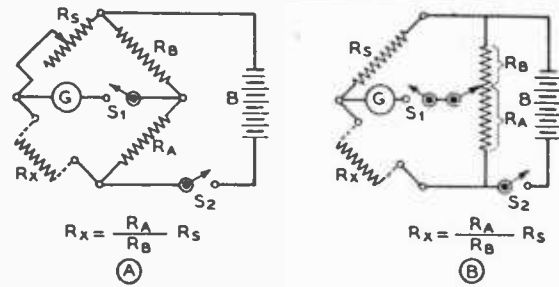

Figure 7. TWO WHEATSTONE BRIDGE CIRCUITS.

These circuits are used for the measurement of d-c resistance. In (A) the "ratio arms" R_A and R_B are fixed and balancing of the bridge is accomplished by variation of the standard R_x . The standard in this case usually consists of a decade box giving resistance in 1-ohm steps from 0 to 1110 or to 11,110 ohms. In (B) a fixed standard is used for each range and the ratio arm is varied to obtain balance. A calibrated slide-wire or potentiometer calibrated in terms of degrees is usually employed as R_A and R_B . It will be noticed that the formula for determining the unknown resistance from the knowns is the same in either case.

brought to zero beat in a receiver. The unknown capacitance is then removed from the circuit and the standard capacitor substituted. The standard capacitor is then carefully tuned until the oscillator is back at zero beat on the original frequency. The capacitance of the unknown capacitor may then be read directly from the calibration curve of the standard capacitor.

The Bridge Method Experience has shown that the most satisfactory method for measuring circuit constants (resistance, capacitance, and inductance) at audio frequencies is by means of the a-c bridge. The Wheatstone (d-c) bridge is also the most accurate method for the measurement of d-c resistance. With a simple bridge of the type shown at Figure 7A it is entirely practical to obtain d-c resistance determinations accurate to four significant figures. With an a-c bridge operating within its normal rating as to frequency and range of measurement it is possible to obtain results accurate to three significant figures.

Both the a-c and the d-c bridges consist of a source of energy, a standard or reference of measurement, a means of balancing this standard against the unknown, and a means of indicating when this balance has been reached. The source of energy in the d-c bridge is a battery; the indicator is a sensitive galvanometer. In the a-c bridge the source of energy is an audio oscillator (usually in the vicinity of 1000 cycles), and the indicator is usually a pair of headphones. The standard for the d-c bridge is a resistance, usually in the form of a decade box. Standards for the a-c bridge can be resistance, capacitance, and inductance in varying forms.

Figure 7 shows two general types of the Wheatstone or d-c bridge. In (A) the so-called "ratio arms" R_A and R_B are fixed (usually in a ratio of 1-to-1, 1-to-10, 1-to-100, or 1-to-1,000) and the standard resistor R_x is varied until the bridge is in balance. In commercially manufactured bridges there are usually two or more buttons on the galvanometer for progressively increasing its sensitivity as balance is approached. Figure 7B is the so-called "slide wire" type of bridge in which fixed standards are used and the ratio arm is continuously variable. The "slide wire" may actually consist of a moving contact along a length of wire of uniform cross section, in which case the ratio of R_A to R_B may be read off directly in centimeters or inches, or in degrees of rotation if the slide wire is bent around a circular former. Or the "slide wire" may consist of linear-wound potentiometer with its dial calibrated in degrees or in resistance from each end.

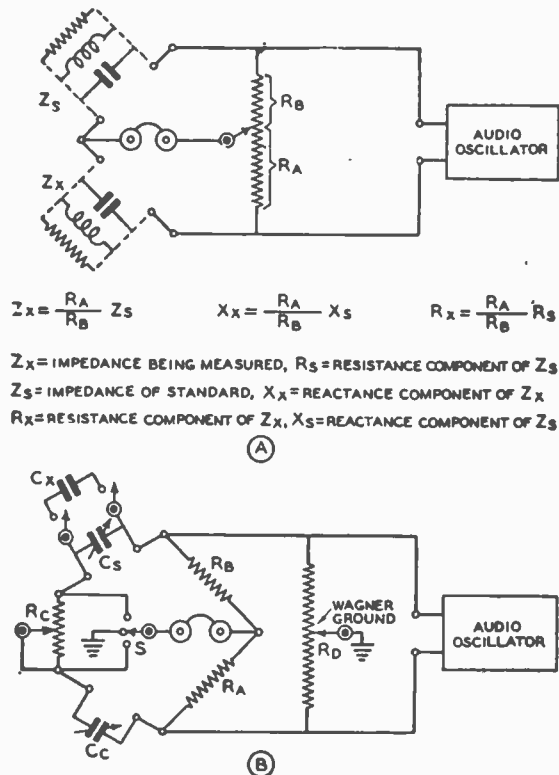

$$Z_x = \frac{R_A}{R_B} Z_s \quad X_x = \frac{R_A}{R_B} X_s \quad R_x = \frac{R_A}{R_B} R_s$$

Z_x = IMPEDANCE BEING MEASURED, R_s = RESISTANCE COMPONENT OF Z_s
 Z_s = IMPEDANCE OF STANDARD, X_x = REACTANCE COMPONENT OF Z_x
 R_x = RESISTANCE COMPONENT OF Z_x, X_s = REACTANCE COMPONENT OF Z_s

Figure 8.
TWO A-C BRIDGE CIRCUITS.

The operation of these bridges is essentially the same as those of Figure 7 except that a.c. is fed into the bridge instead of d.c. and a pair of phones is used as the indicator instead of the galvanometer. The bridge shown at (A) can be used for the measurement of resistance, but it is usually used for the measurement of the impedance and reactance of coils and capacitors at frequencies from 200 to 1000 cycles. The bridge shown at (B) is used for the measurement of small values of capacitance by the substitution method. Full description of the operation of both bridges is given in the accompanying text.

Figure 8A shows a simple type of a-c bridge for the measurement of capacitance and inductance. It can also, if desired, be used for the measurement of resistance. The four arms of the bridge may be made up in a variety of ways. As before, R_B and R_A make up the ratio arms of the device and may be either of the slide-wire type, as indicated, or they may be fixed and a variable standard used to obtain balance. In any case it is always necessary with this type of bridge to use a standard which presents the same type of impedance as the unknown being measured: resistance standard for a resistance measurement, capacitance standard for capacitance, and inductance standard for inductance determination. Also, it is a great help in obtaining an accurate balance of the bridge if a standard of approximately the same value as the assumed value of the unknown is employed. Also, the standard should be of the same general type and should have approximately the same power factor as the unknown impedance. If all these precautions are observed, little trouble will be experienced in the measurement of resistance and in the measurement of impedances of the values usually used in audio and low radio frequency work.

However, the bridge shown at 8A will not be satisfactory for the measurement of capacitances smaller than about 1000 μμfd. For the measurement of capacitances from a few micro-microfarads to about 0.001 μfd. a Wagner grounded substitution capacitance bridge of the type shown in Figure 8B will be found quite satisfactory. The ratio arms R_A and R_B should be of the same value within 1 per cent; any value between 2500 and 10,000 ohms for them both will be satisfactory. The two

resistors R_C and R_D should be 1000-ohm wirewound potentiometers. C_B should be a straight-line capacitance capacitor with an accurate vernier dial; 500 to 1000 μμfd. will be satisfactory. C_T can be a two or three gang broadcast capacitor from 700 to 1000 μμfd. maximum capacitance.

The procedure for making a measurement is as follows: The unknown capacitor C_x is placed in parallel with the standard capacitor C_s. The Wagner ground R_D is varied back and forth a small amount from the center of its range until no signal is heard in the phones with the switch S in the center position. Then the switch S is placed in either of the two outside positions, C_T is adjusted to a capacitance somewhat greater than the assumed value of the unknown C_x, and the bridge is brought into balance by variation of the standard capacitor C_s. It may be necessary to cut some resistance in at R_C and to switch to the other outside position of S before an exact balance can be obtained. The setting of C_s is then noted, C_x is removed from the circuit (but the leads which went to it are not changed in any way which would alter their mutual capacitance), and C_s is readjusted until balance is again obtained. The difference in the two settings of C_s is equal to the capacitance of the unknown capacitor C_x.

Measurement of Q There are two commonly used methods for the measurement of the Q or of equivalent series resistance of a tuned circuit which give good results for all frequencies within the communication range. The first is called the Resistance Neutralization Method. It will be described but briefly because a rather specialized piece of equipment must be built up to make the tests. A complete description of the system including certain variations is given in Terman's *Measurements in Radio Engineering*.*

The circuit diagram of the unit is given in Figure 9. With about 3 volts of grid bias on the 24 tube the potentiometer R₁ is adjusted until the plate current is zero. The circuit under test is placed in the plate circuit of the dynatron oscillator. The grid bias on the dynatron is then varied until the tuned circuit is just on the verge of going into or out of oscillation. The presence of oscillations may be detected with the aid of a radio receiver if the tuned circuit is for r.f.; or the oscillations may be detected by dangling a pair of headphone cords near the circuit if the circuit is an a-f one. At the point where oscillation is unstable the negative resistance of the dynatron is almost exactly equal to the parallel impedance of the tuned circuit under test. The tuned circuit is then shorted out by the switch S, the shunt is removed from the microammeter, and the plate voltage is increased 1 to 2 volts by potentiometer R₂. This adjustment will cause a small plate current change as indicated by the microammeter. The negative resistance of the dynatron under these conditions of operation is then determined by the ratio: (increase in plate voltage)/(change in plate current). This negative resistance is numerically equal to the resonant impedance of the tank circuit under measurement.

The Q of the tank circuit may then be determined, after the inductance of the coil has been determined by a bridge or other method, through use of the following formula: $Q = R_n/2\pi fL$.

The other method of determining Q is direct indicating and is called the Frequency-Variation Method. This method of Q determination is diagrammed in Figure 10. The output of the oscillator must be constant throughout the measurement, and the coupling between the oscillator and the tank under measurement must be constant and wholly inductive. It is for this reason that a Faraday electrostatic shield is indicated between the two tuned circuits.

*Available from our book department for \$4.50 postpaid; foreign, \$4.75. 400 pages, 208 illustrations; covers basic principles and specific problems of measurements in radio practice.

- R₁—50,000-ohm potentiometer
- R₂—2500-ohm potentiometer
- R₃—50-ohm potentiometer
- R₄—Shunt for microammeter
- B₁—9-volt battery
- B₂—135-volt battery
- B₃—4.5-volt battery
- S—Tank ckt. shorting switch
- S₁—Microammeter shunt switch
- S₂—Voltage increment switch
- M—Tank under measurement

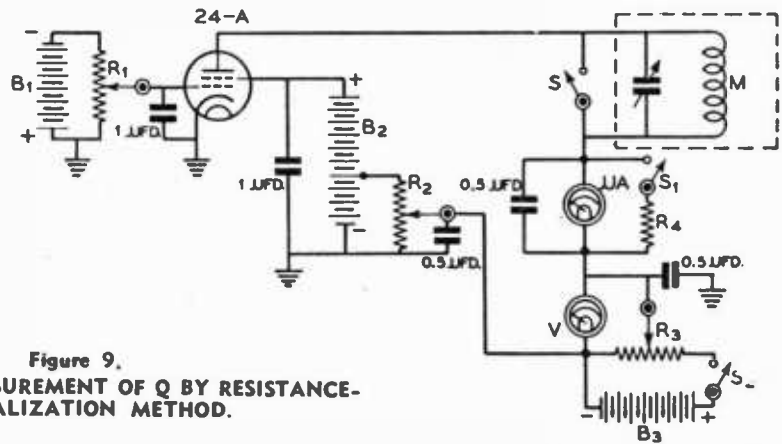

Figure 9.
CIRCUIT FOR MEASUREMENT OF Q BY RESISTANCE-NEUTRALIZATION METHOD.

The tank circuit is loosely coupled to the oscillator and the response voltage (E_o) at resonance (F_o) is noted by the v.t.v.m. The frequency of the oscillator is then decreased to some value which gives a conveniently lower indication of voltage at the v.t.v.m. This frequency (F_1) and response voltage (E_1) is noted and the frequency of the oscillator is then increased beyond resonance to the point which gives the same v.t.v.m. indication as was found at F_1 . This higher frequency is then noted as F_2 . It is important that the current in the tank circuit of the oscillator must remain constant throughout the process. The Q of the tank circuit is then determined by the following formula:

$$Q = \frac{F_o}{F_2 - F_1} \sqrt{\frac{E_1^2}{E_o^2 - E_1^2}}$$

It must be remembered that the tank circuit Q as determined by either of the above two systems is not exactly equal to the Q of the inductor. But if the capacitor making up the circuit is air-tuned, or of a high-quality mica type, the tank circuit Q will be approximately the same as the Q of the inductance.

31-3 Frequency Measurements

All frequency measurement within the United States is based on the transmissions of Station WWV of the National Bureau of Standards. This station operates continuously on frequencies of 5, 10, 15, 20, 25, 30, and 35 Mc. The carriers are all modulated by a 440-cycle tone which is interrupted for the hour and each five minutes thereafter for a period of precisely one minute. Eastern Standard Time is given in code during these one-minute intervals. The 10, 15, 20, and 25 Mc. transmission and the 5 Mc. daytime transmission are also modulated by a 4000-cycle tone simultaneously with the 440-cycle tone. The accuracy of all radio and audio frequencies is better than one part in 50,000,000. A 5000 microsecond pulse

may be heard as a tick for every second except the 59th second of each minute.

These standard-frequency transmissions of station WWV may be used for accurately determining the limits for the various amateur bands with the aid of the station communications receiver and a 50-kc., 100-kc., or 200-kc. band-edge spotter. The low-frequency oscillator may be self-excited if desired, but low-frequency standard crystals have become so relatively inexpensive that a reference crystal may be purchased for very little more than the cost of the components for a self-excited oscillator. The crystal has the additional advantage that it may be once set so that its harmonics are zero beat with WWV and then left with only an occasional check to see that the frequency has not drifted more than a few cycles. The self-excited oscillator, on the other hand, must be monitored very frequently to insure that it is on frequency.

Using a Frequency Spotter To use a frequency spotter it is only necessary to couple the output of the oscillator unit to the antenna terminal of the receiver through a very small capacitance such as might be made by twisting two pieces of insulated hookup wire together. Station WWV is then tuned in on one of its harmonics, 15 Mc. will usually be best in the daytime and 5 or 10 Mc., at night, and the trimmer adjustment on the oscillator is varied until zero beat is obtained between the harmonic of the oscillator and WWV. With a crystal reference oscillator no difficulty will be had with using the wrong harmonic of the oscillator to obtain the beat, but with a self-excited oscillator it will be wise to insure that the reference oscillator is operating exactly on 50, 100, or 200 kc. (whichever frequency has been chosen) by making sure that zero beat is obtained simultaneously on all the frequencies of WWV that can be heard, and by noting whether or not the harmonics of the

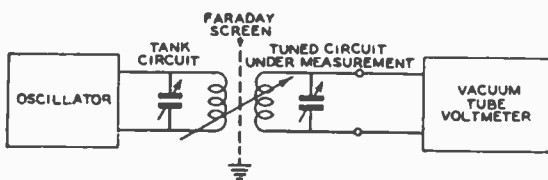

Figure 10.
CIRCUIT FOR MEASUREMENT OF Q BY FREQUENCY-VARIATION METHOD.

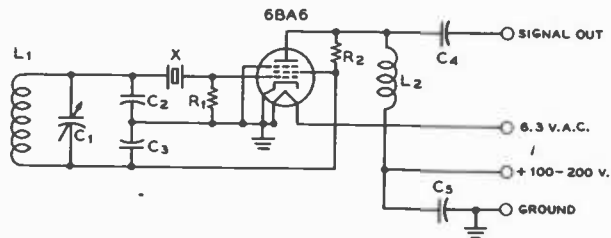
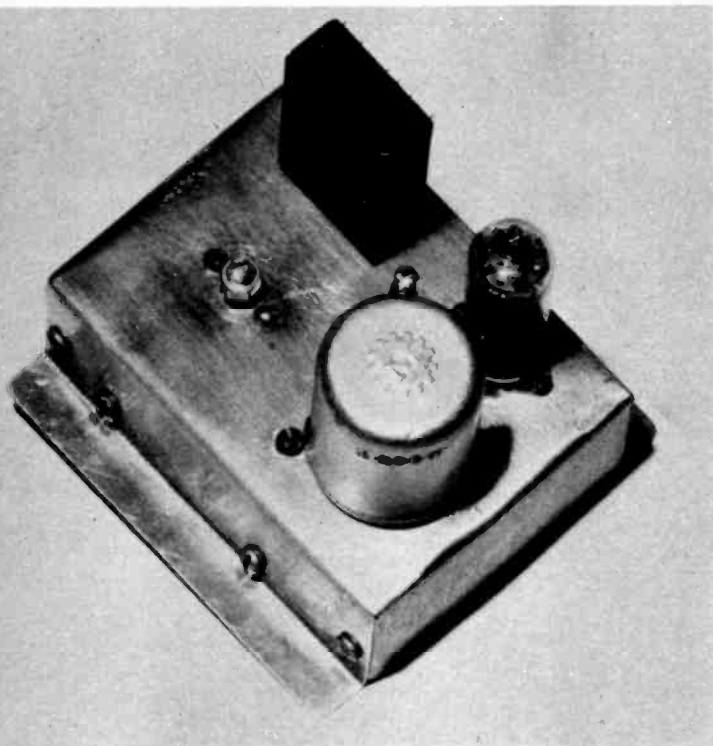

Figure 11.
SCHEMATIC OF THE 100-KC. FREQUENCY SPOTTER
C₁—100-μfd. air trimmer
C₂, C₃—0.0003-μfd. midget mica
C₄—50-μfd. midget mica
C₅—0.002-μfd. midget mica
R₁, R₂—100,000 ohms 1/2 watt
L₁—10-mh. shielded r-f choke
L₂—2.1-mh. r-f choke
X—100-kc. crystal



oscillator in the amateur bands fall on the approximate calibration marks of the receiver.

100-KILOCYCLE FREQUENCY SPOTTER

The unit shown in Figures 12 and 13 and diagrammed in Figure 11 may be used for two similar but different applications. The first application is as a band-edge frequency spotter. When used for this purpose the unit is normally installed somewhere inside the receiver housing and its output is cou-

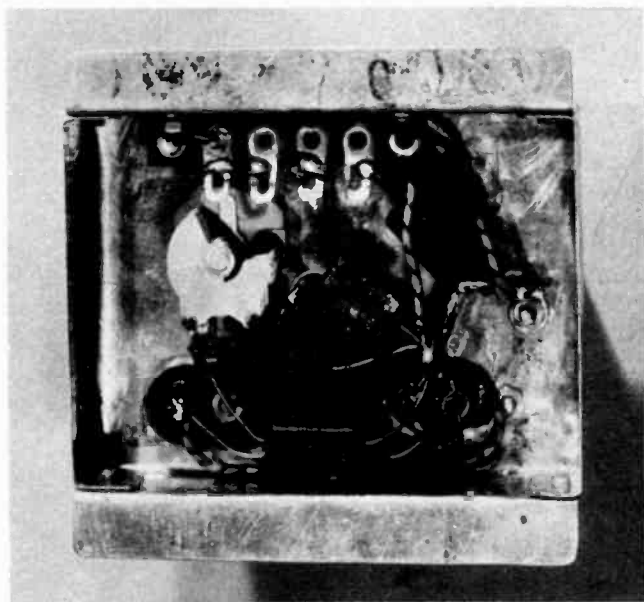

Figure 13.

UNDERCHASSIS VIEW OF THE FREQUENCY SPOTTER.
The four-terminal tie-point is used to make connections between the receiver or v.f.o. into which the unit is installed and the 100-kc. oscillator unit itself.

Figure 12.

TOP VIEW OF THE 100-KC. FREQUENCY SPOTTER.

pled into the antenna circuit of the receiver. The very low power requirements of the 6BA6 crystal oscillator tube can be obtained directly from the receiver power supply.

The second application of the frequency spotter is as a calibration check for a variable-frequency oscillator. For this application the unit is normally installed inside the v-f-o housing and used in combination with a simple audio amplifier such as a cascaded 6SL7 operating into a pair of phones. In this application C_1 is coupled to the grid of the first half of the 6SL7 and in addition a small amount of r-f energy from the v.f.o. is coupled also to this grid. With this type of circuit arrangement the 100-kc. calibration points on the main dial for the v.f.o. may be checked whenever operation near the edge of an amateur band is contemplated.

The Oscillator Circuit A 100-kc. crystal is used as a coupling gate to the grid of the oscillator tube in conjunction with a Colpitts oscillator circuit. Due to

the sharpness of resonance of the quartz crystal the oscillator will operate only over a comparatively narrow range very close to the crystal frequency. The circuit shown, in which the screen grid is fed plate voltage from the plate of the tube instead of from $B+$, was found to give the best harmonic output. Tests of the unit have shown that adequate harmonic output is available up to 30 Mc. The capacitor C_1 has been provided to allow trimming of the oscillator frequency exactly to 100 kc. This adjustment may be made by listening to the beat in a communications receiver between one of the harmonics of the oscillator and WWV. Capacitor C_1 is varied while listening to the beat note until zero beat is obtained.

WAVEMETERS

The absorption wavemeter as a device for obtaining an approximate frequency check is a very valuable unit of simple test equipment. Although the accuracy of the very simple types is only of the order of 10 per cent, this is an ample degree of

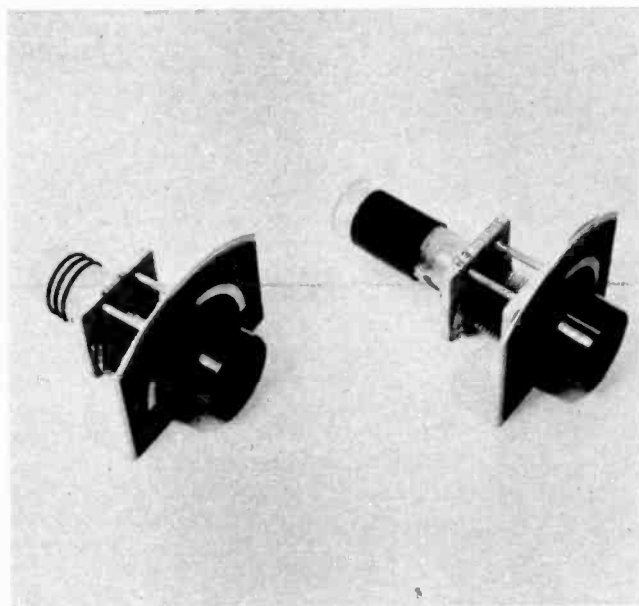
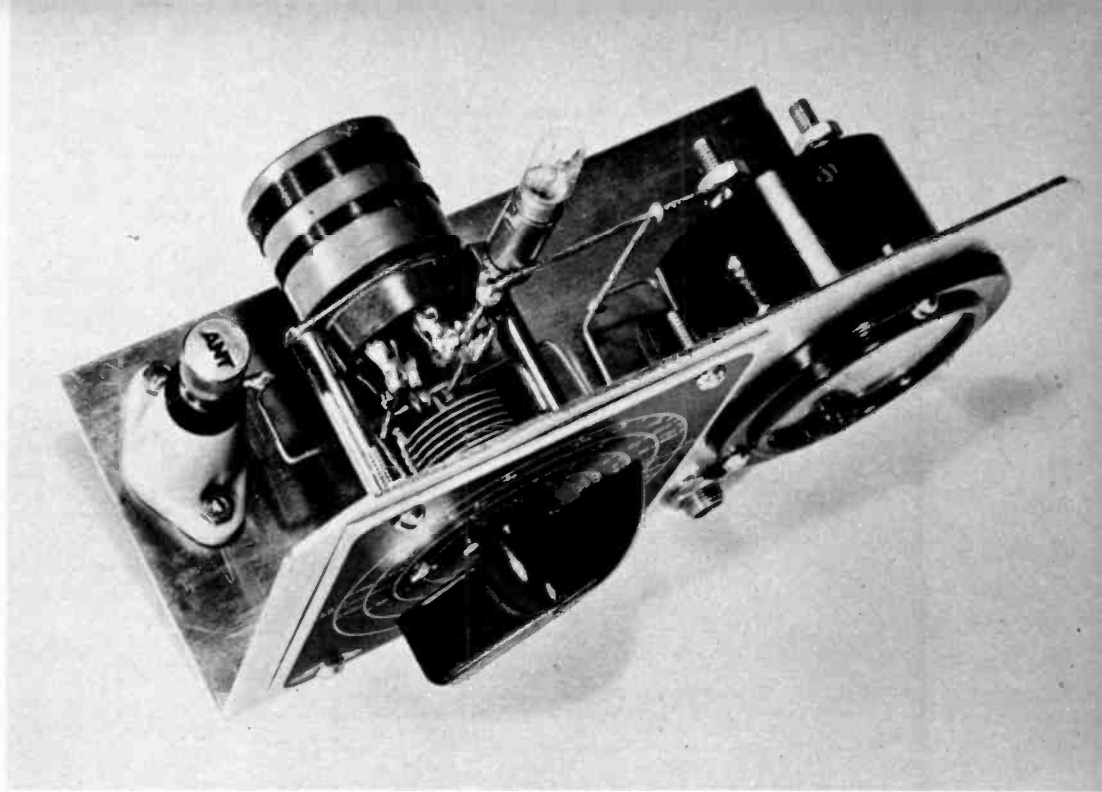

Figure 14.

TWO PRACTICAL WAVEMETERS OF AN INEXPENSIVE TYPE

**Figure 15.
TOP VIEW OF THE SENSITIVE
WAVEMETER OR FIELD-
STRENGTH METER.**



accuracy for determining the harmonic upon which a frequency multiplier stage is operating. Figure 14 shows two simple wavemeters (Millen Mfg. Co.) of an inexpensive type whose accuracy is adequate for this type of measurement.

WAVEMETER/FIELD-STRENGTH METER

Three of the most used pieces of equipment around an amateur station are a wavemeter, a phone monitor and a field-strength indicator. Separate units are not necessary and all three functions can be combined into one instrument.

Figures 15 and 16 illustrate a compact, sensitive device which can be used as a simple wavemeter with either meter or pilot light indicator, as an excellent phone monitor to check hum and quality of modulation and as a sensitive field-strength indicator for adjusting antennas or maximum output of a transmitter.

A McMurdo Silver model 903 absorption type wavemeter, with coils covering from 1.6 to 400 megacycles is used as the basis. The dial plate of this wavemeter has the calibration of each coil etched on the plate. As used in this instrument, the calibration will be thrown slightly off. While the error between actual frequency and indicated frequency is not serious for normal use, if greater accuracy is desired, it will be necessary to recalibrate the instrument.

As received from the manufacturer, the 903 meter consists of a combined dial and mounting plate on which is mounted a midget variable capacitor between two metal posts which support a tube socket which also holds an indicating light. The coils are wound on low-loss tube-base type forms. Seven coils cover the complete range with overlap between coils. Each form holds two windings. One, the tuned circuit, is

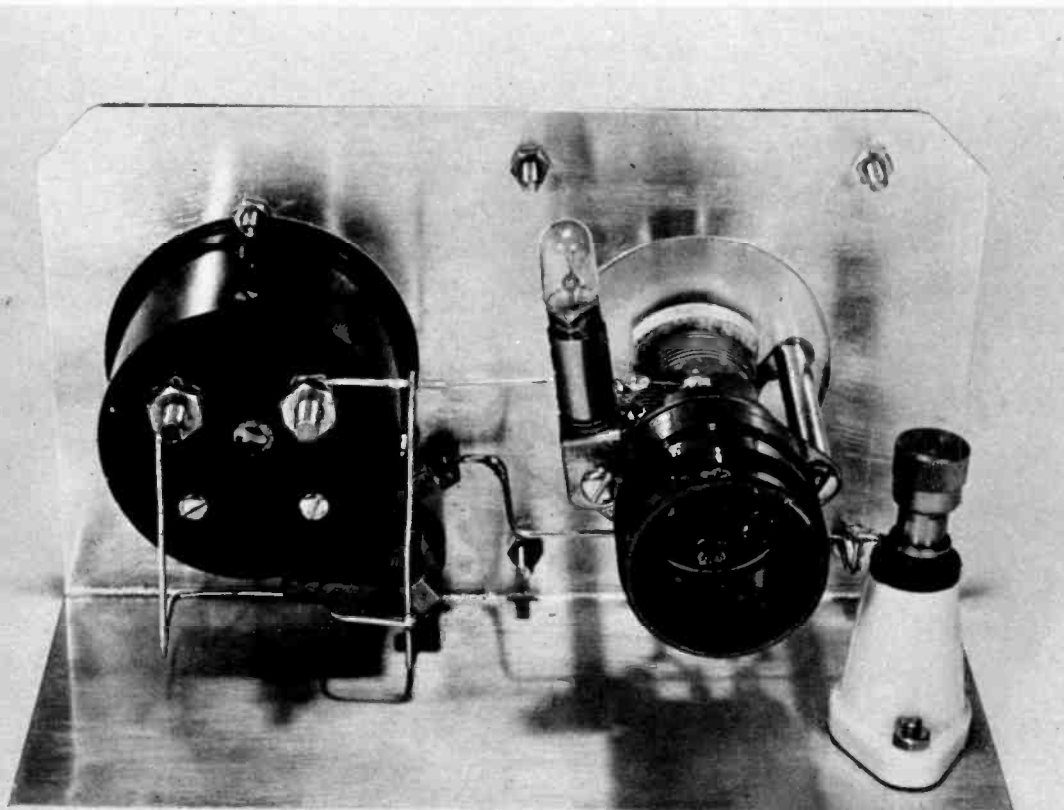

**Figure 16.
REAR VIEW OF THE
WAVEMETER.**

The dial lamp should be removed from its socket when greatest sensitivity is desired.

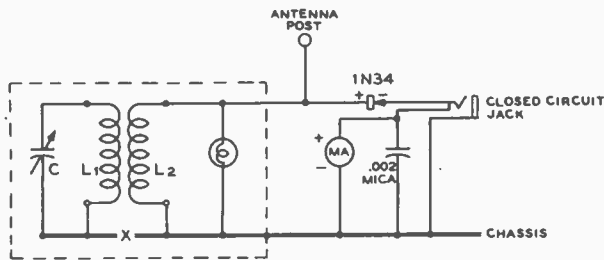

Figure 17.
SCHEMATIC DIAGRAM OF THE SENSITIVE
WAVEMETER.

A Silver Model 903 wavemeter is used as the basis of the unit, and is indicated by the components within the dashed box in this illustration. In the unit as supplied there is not a common ground between the tank circuit and the output circuit. However, if a connection is made across the point "X" in this diagram the body capacitance effect on the unit will be greatly reduced. However, when a common ground connection is used the calibration on the dial of the wavemeter is thrown off somewhat, the indicated frequency being in all cases approximately 8 per cent higher than the actual frequency.

inductively coupled to the other which has the indicating light connected across it.

To convert the 903 meter, a 1N34 germanium crystal rectifier is used with a 0-200 microammeter. The microammeter provides considerably increased sensitivity over a 0-1 milliammeter, as an aid in field-strength work. The 1N34 rectifier is smaller than a 2-watt resistor and makes an ideal rectifier to use with the indicating meter. A headphone jack, antenna binding post and meter by-pass capacitor complete the parts used.

If a 2½ inch (face diameter) indicating meter is used, the unit may be constructed on a piece of aluminum 7 x 7 inches which is bent to provide a front panel measuring 4 x 7 inches and a base 3 x 7 inches.

No alterations are made to the type 903 wavemeter other than grounding the rotor terminal of its tuning capacitor to a soldering lug placed under one of the coil socket mounting posts. This connects the two coils together. With the dial light indicator in the socket, a low enough shunt is provided across the microammeter to prevent burning it out even when the wavemeter is coupled close enough to a transmitter to light the lamp to full brilliancy. With the lamp out of its socket however, the instrument should not be brought too close to a strong r.f. field without first checking the deflection of the meter and making sure it is within safe limits.

A circuit-closing jack is incorporated for operation as a phone monitor. It is wired so that when a headphone plug is inserted the meter is removed from the circuit entirely, permitting the instrument to be brought close to the transmitter

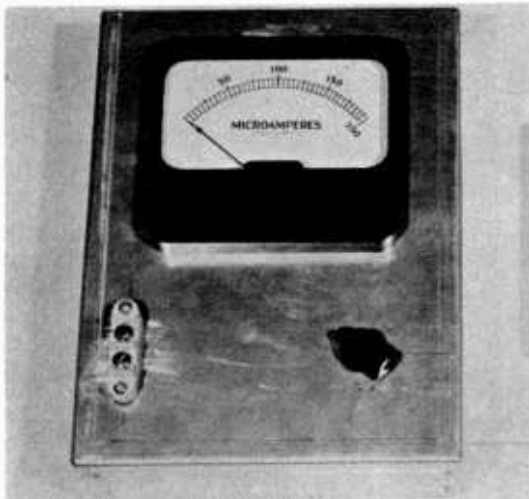

for adequate pickup. With the plug out, the meter circuit is closed.

While not normally needed working around a transmitter, a binding post mounted on a standoff insulator provides for connecting an antenna to the instrument when maximum sensitivity and pickup is necessary such as in antenna adjustments. To minimize calibration error, this antenna connects to the untuned coil.

31-4 Construction of Monitoring and Test Equipment

In this section will be described several items of monitoring and test equipment which may be constructed with but a moderate amount of difficulty. The very simple field-strength meter for tuning an antenna array is sure-fire in its operation and involves almost no constructional difficulty. The simple 3-inch oscilloscope is very simple in construction and requires but few components in addition to the oscilloscope power transformer and the cathode-ray tube. Due to the unusual simplicity of the scope in comparison to the satisfactory time base and the assurance that an accurate picture of the amplitude-modulated wave is in view, such a unit could well be included as a monitoring equipment for any but the most simple of AM radiophone stations. The audio oscillator and test amplifier is somewhat in the luxury category for many amateur stations but is a worthwhile addition to the test equipment complement of any station contemplating extensive audio amplifier or radiophone test work.

REMOTE-INDICATING FIELD-STRENGTH INDICATOR

A remote-indicating field-strength meter is a great convenience in the process of tuning an antenna array for best forward gain, for best front-to-back ratio, or for a compromise between these two conditions of operating. Such an instrument is a particular convenience in the process of tuning a multi-element parasitic antenna array of the rotatable type such as has been discussed in Chapter 30.

Figure 19 shows the simple circuit diagram of the instrument and Figure 18 shows a photograph of a mounting for the indicating portion of the instrument. A graph showing the theoretical calibration curve of a voltage-indicating instrument of this type is given in Figure 20. Actual test of the unit has shown that the individual calibration curve falls quite close to the theoretical curve given in Figure 20.

Using the Remote-Indicating Field-Strength Meter The normal application of the remote-indicating field-strength meter is as follows: The output of the station transmitter, or one of the exciter stages, is fed to a temporary antenna (the folded-dipole type usually is quite convenient) of the same polarization as the main antenna under test and located at a distance of at least a wavelength and preferably several wavelengths from the main antenna. A power level between 10 and 50 watts is normally all that will be required to excite the temporary antenna. If possible, the temporary antenna should be at the same height as the antenna under

Figure 18.
THE REMOTE INDICATOR FOR THE FIELD-STRENGTH
METER.

The utter simplicity of the unit is apparent from this photograph. The indicating microammeter is mounted on a chassis with its face upwards so that it may be read easily while working on the antenna system. The large instrument shown is convenient since its indication may be read from a considerable distance, but a smaller instrument may of course be used.

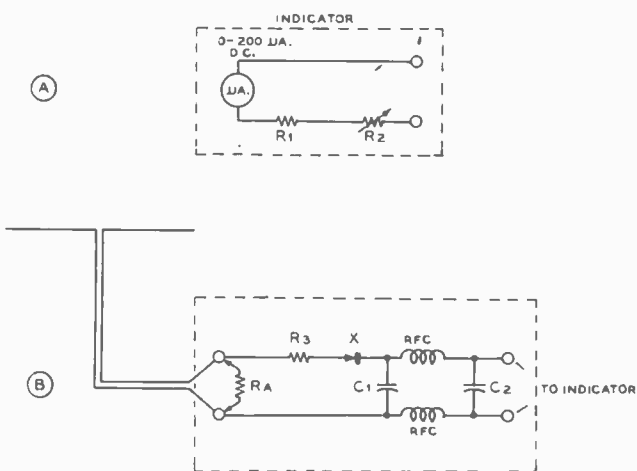

Figure 19.
SCHEMATIC OF THE REMOTE-INDICATING FIELD-STRENGTH METER.

(A) shows the internal connections for the indicating portion of the field-strength meter. R_1 is a 4700-ohm $\frac{1}{2}$ -watt resistor and R_2 is a 50,000-ohm potentiometer. (B) shows the schematic of the rectifying portion of the remote-indicating field-strength meter. The two units may be separated by any distance up to several hundred feet. Resistor R_A should be made equal to the characteristic impedance of the transmission line to be used to feed the array under test. R_2 is a 10-ohm 1-watt non-inductive carbon resistor, X is a rectifying crystal (type 1N34 is suitable), RFC are two r-f chokes suitable for the band of operation, and C_1 and C_2 are each 0.003- μ fd. midget mica capacitors.

test, although the temporary antenna may be somewhat lower if necessary.

The rectifying portion of the field-strength meter (Figure 19B) is then connected either across the feed terminals of the antenna under test or at the end of a section of transmission line of the type to be used to feed the antenna. Any matching sections, stubs, or transformers which are to be used to accomplish the matching between the antenna feed point and the main transmission line are installed in their normal manner between the antenna under test and the rectifying portion of the field-strength meter. Then a resistor (R_A in Figure 19B) equal to the characteristic impedance of the transmission line which is in use or which will be used is placed across the terminals of the rectifying unit to act as a non-reflecting load for the energy picked up by the antenna. The resistor used for R_A should be of the non-inductive type. Composition resistors such as the Ohmite "Little Devil" have proven to be quite satisfactory in this application. The resistor need not be of exactly the same resistance as the transmission line so long as it is quite close in value; as examples, a standard 47-ohm resistor may be used as termination for a 52-ohm coaxial line or a 620-ohm resistor may be used as termination for a 600-ohm line.

The resistor R_A serves, as mentioned before, as a load to dissipate the energy received by the antenna under test. Since it is equal in resistance to the characteristic impedance of the transmission line which will be used to feed the antenna, it makes no difference whether or not an actual section of this transmission line is used between the feed point of the antenna and the rectifying unit of the field-strength meter. The feed point of the antenna "sees" the same value of impedance whether it is terminated in the resistor or in a section of transmission line which is in turn terminated in its characteristic impedance by a resistor. Hence, if the whole antenna system is matched to the value of resistance which has been used as R_A , there will be no reflections from this termination. It is desirable, therefore, that an impedance-matching system calculated to meet the operating conditions chosen by the pro-

cedures discussed in Chapter 30 can be used between the driven element in the antenna and the place where the antenna transmission line connects to the antenna system. Although the calculated matching system may not be exactly correct, the method of tuning for maximum gain discussed in the following paragraphs will give excellent results if the impedance matching system which has been installed is approximately correct.

Tuning for Maximum Forward Gain The rectifying portion of the remote-indicating field-strength meter is placed, as mentioned before, either directly at the feed point of the antenna system or at the end of a section of transmission line of the type to be used to feed the antenna. Then a pair of wires is run from the rectifying unit to the indicating unit of the f-s meter. Any type of wire may be used since this line carries only a small value of direct current, but receiving twinlead of the 75-ohm or 150-ohm variety is often used since it is small and convenient and actually less expensive than conventional 115-volt cord. The indicating unit can best be placed on the ground in a position where it may be seen while adjustments are being made on the antenna.

Resistor R_1 on the indicating instrument is then adjusted for maximum series resistance in the indicating circuit. Then the transmitter or exciter unit is tuned up on the desired frequency of operation and coupled to the temporary test antenna. Power is applied to the transmitter and the control resistor R_1 in the indicating instrument is adjusted until the meter reads about half scale. It is then advisable to rotate the antenna slightly back and forth to insure that the antenna under test is pointing directly at the temporary transmitting antenna.

With the driven element adjusted to the theoretical length as determined by reference to Chapter 30 the director is now varied in length a small amount at a time until maximum indication is obtained on the field-strength meter. A good starting point for the lengths of the director and reflector can be obtained by reference to Figure 2 in Chapter 30. After the director has been maximized the reflector is varied until the field-strength meter reading increases to a new maximum value. It is now wise to make small adjustments in the length of the driven element to insure that its length is optimum for the frequency which has been chosen.

Since the adjustments of the elements are interacting in their

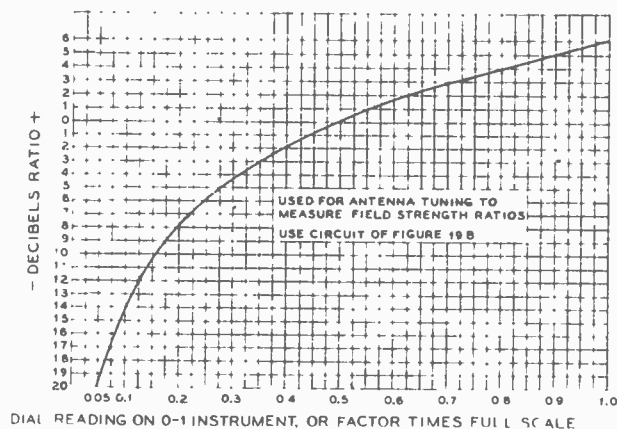

Figure 20.
THEORETICAL DECIBELS VS. METER INDICATION FOR THE INDICATING INSTRUMENT.

Laboratory checks of a sample unit have shown that an actual calibration curve comes very close to the theoretical curve shown. See the associated text for a discussion of the use of this graph.

effects on the field strength from the antenna it is necessary to repeat the adjustment procedure described above at least once and preferably several times so that a set of compromise lengths for the elements may be determined which will give maximum forward signal from the antenna system. If the antenna system was far out of tune when the adjustment procedure was started it will probably be necessary to back down the resistor R_1 on the indicator unit to keep the needle deflection from going off scale. When more than one director is used in the antenna system it is usually best to adjust the director adjacent to the driven element first, and then to proceed outward.

Measuring the Radiation Pattern With the antenna under test pointing directly at the temporary transmitting antenna the resistor R_1 is adjusted for full scale deflection. Then the antenna is rotated through 90° in both directions to determine the front-to-side ratio and through 180° to determine the front-to-back ratio. The front-to-back and front-to-side ratios in decibels may be obtained by reference to the chart given in Figure 20, or the meter scale itself on the indicating instrument may be calibrated. This graph has been drawn on the assumption that the "on the nose" reference point would be at half scale on the indicating meter, from whence the meter will read up 6 db and down 20 db from the reference level. However, if full scale on the meter is chosen as the reference level, or zero db, as mentioned at the start of this paragraph, 6 decibels should be subtracted from each of the numbers in the "decibels ratio" column on the left of the graph. Thus the meter will read "zero db" at full scale, "minus 6 db" at half scale, "minus 12 db" at quarter scale, and "minus 26 db" at 1/20 or 0.05 scale.

It is often convenient to prepare an actual field-intensity pattern of the antenna under the test conditions in use. To do this it is necessary first to note down in tabular form the relative field intensity for every 10° or 15° of antenna rotation. Then, on a piece of polar-coordinate graph paper obtained from an office-supply or draftsmen's-supply house, note down the points just tabulated. Zero field intensity will be at the center of the graph and the maximum meter reading obtained will be the last circle on the piece of graph paper. An actual plot of the radiation pattern from an antenna when made in this manner will often be very revealing in regard to the width of the nose of the pattern, the presence of spurious side lobes or of a large back lobe.

Tuning for Maximum Front-to-Back Ratio In the event that an unusually large back lobe is found, or should it be desired to reduce the back lobe to a minimum to afford a reduction in interference from the rear, it is possible to retune an antenna for best front-to-back ratio. It is best first to tune the array for maximum forward gain to insure that the antenna system is operating properly and then to make a revision in the settings of the elements to improve the front-to-back ratio. First point the antenna toward the temporary transmitting antenna and adjust the meter reading for full scale. Then turn the antenna through 180° and adjust the reflector for minimum reading on the indicating instrument. Then turn the antenna through 180° again and check the forward reading. Peak the director for maximum forward reading and again reverse the antenna. Re-trim the reflector for minimum backward reading and again check the forward signal. By repeating the procedure several times it will be possible to obtain an improved value of front-to-back ratio with a relatively small decrease in the forward gain of the antenna system. A considerable amount of jockeying in the lengths of the directors and the reflector is required to obtain the optimum lengths for a compromise value of forward

gain along with the greatest value of front-to-back ratio.

Antenna systems which use more than one director will inherently give a better front-to-back ratio in addition to greater forward gain as compared to antenna systems which use only one director. Hence, with these types of antennas it will in most cases be necessary only to adjust for maximum forward gain; a sufficient degree of front-to-back ratio will usually be obtained with the adjustment for maximum forward gain.

Checking for Actual Antenna Gain It is possible to determine the actual gain of the antenna under test relative to a dipole radiator simply by replacing the directive array by a dipole located at the same position. The dipole should be matched to a transmission line of the same impedance as used to feed the antenna array. With a standard amount of input to the transmitter feeding the test antenna the resistor on the indicating instrument is varied until the meter reads half scale. Then, with all other conditions remaining the same, the directive array is replaced by the dipole which is matched to the same impedance as was used to feed the directive array. The rectifying portion of the meter is connected to the feed line from the dipole and the meter reading noted with the same input to the transmitter and with no changes having been made in the setting of the rheostat in the indicating instrument.

THREE-INCH MONITORING OSCILLOSCOPE

Experience has shown that the only really satisfactory method of monitoring an amplitude-modulated transmitter is with the aid of a cathode-ray oscilloscope. Indication such as afforded by the plate milliammeter on the Class B stage or by a modulation monitor which operates from averaged values

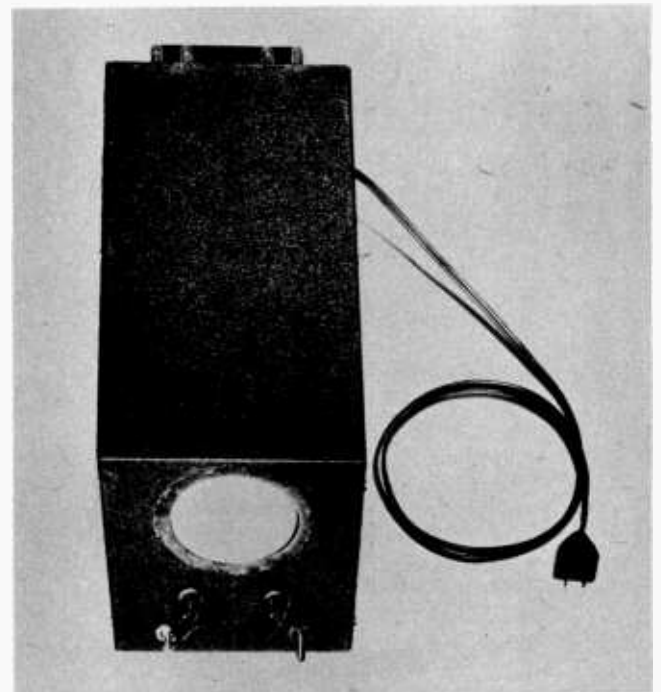

Figure 21.
FRONT VIEW OF THE SIMPLE 3-INCH MONITORING OSCILLOSCOPE.

The left-hand control on the front panel is the intensity control and the one on the right-hand side is for focus. The left switch is the on-off switch and the switch on the right-hand side changes the horizontal deflection plates from internal sweep to a pair of binding posts on the rear of the unit above the power transformer.

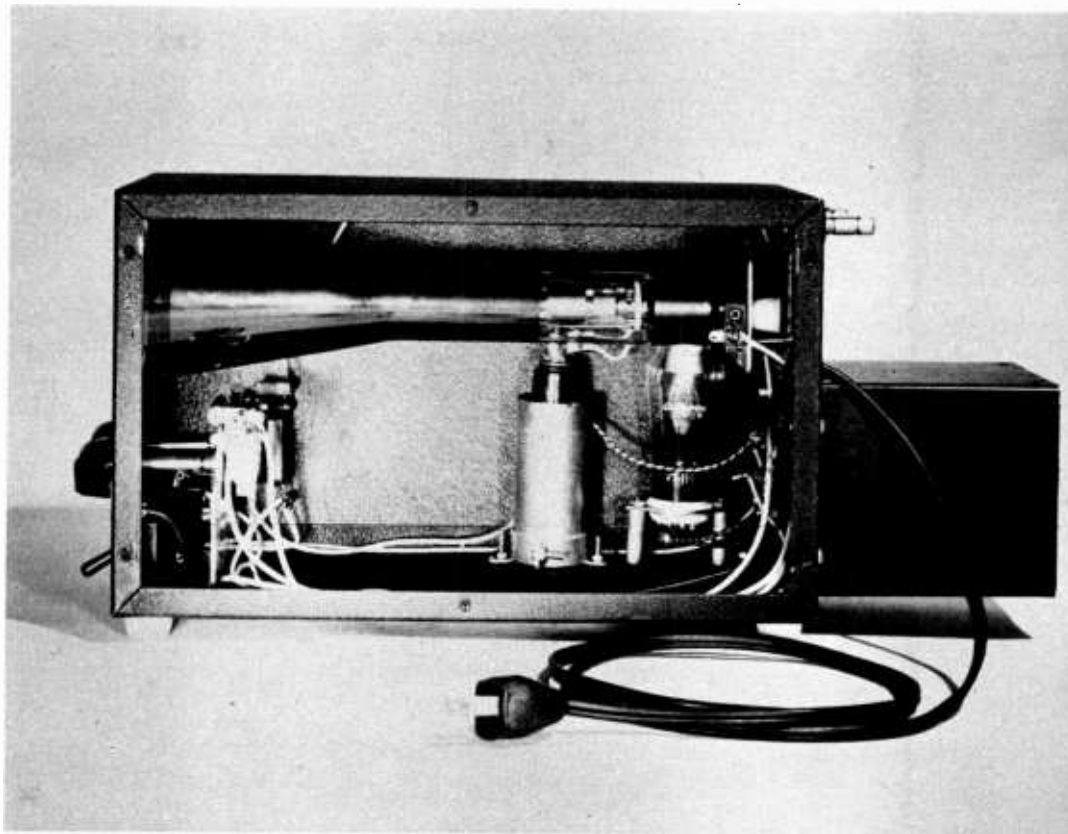

Figure 22.
SIDE VIEW OF THE 3-INCH
OSCILLOSCOPE WITH SIDE
PANEL REMOVED.

of rectified audio frequency can give only an idea of the average modulation level and cannot show modulation peaks of the type which produce sideband splatter. A cathode-ray oscilloscope, on the other hand, will give instantaneous indication of the peak modulation level and hence can show immediately any tendency toward negative-peak clipping. The normal way of operating an oscilloscope for such use is to apply a low-frequency linear time base to the horizontal deflection plates and to apply the radio-frequency carrier envelope from the transmitter to the vertical deflection plates. Normal modulation of the transmitter will be evidenced by the conventional increases and decreases in amplitude of the carrier in accordance with the waveform of the speech signal. Negative-peak clipping is made strikingly apparent by the fact that bright spots are formed in the center of the carrier envelope whenever the instantaneous carrier amplitude goes to zero.

The most satisfactory method of using an oscilloscope as a modulation monitor is to have the unit installed on the operating table with the screen in easy view of the person who is speaking into the microphone. It is then a relatively easy matter to adjust the gain control and the loudness of speech to such a level that satisfactory modulation with only a very occasional peak indicated by a bright spot in the screen is obtained.

The Sweep Circuit The oscilloscope illustrated in Figures 21 and 22 was developed especially for the application of monitoring an amplitude-modulated telephone transmitter. The unit incorporates an unusual and very simple internal sweep circuit requiring no additional tubes which carries a single stroke across the screen of the oscilloscope tube on alternate half cycles of the 60-cycle line fre-

Figure 23.
SCHEMATIC OF THE 3-INCH OSCILLOSCOPE

- C₁—0.25- μ fd. 2500-volt scope capacitor
- C₂—0.002- μ fd. 1250-volt working mica
- C₃, C₄—0.01- μ fd. 400-volt tubular
- R₁—1.0-megohm 1-watt resistor
- R₂—5.0-megohm 1-watt resistor
- R₃—220,000-ohm 1-watt resistor
- R₄—250,000-ohm potentiometer
- R₅—100,000-ohm 1-watt resistor
- R₆—50,000-ohm potentiometer
- R₇—470,000-ohm 1-watt resistor
- R₈, R₉—1.0-megohm 1/2-watt resistors
- T—Scope transformer—1250 volts at 2 ma.,
2.5 v. at 1.75 a. for 2X2, 2.5 v. at 2.1 a.
for 3AP1 or 6.3 v. at 0.6 a. for 3BP1.
- S₁—S.p.s.t. a-c line switch
- S₂—D.p.d.t. toggle switch

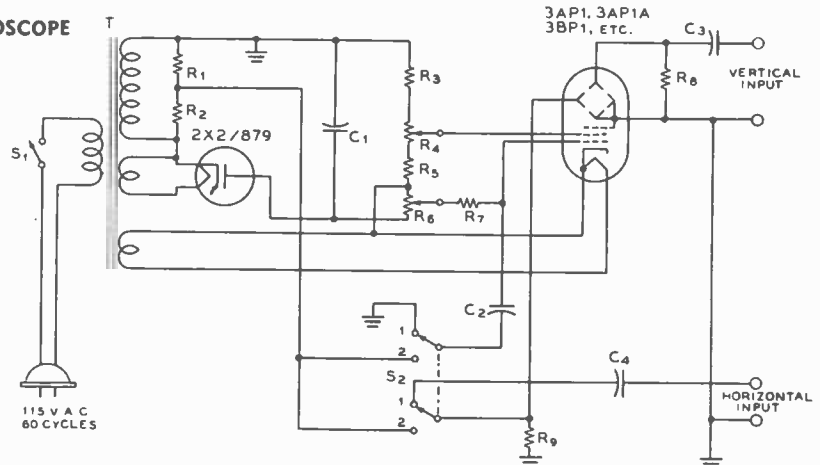

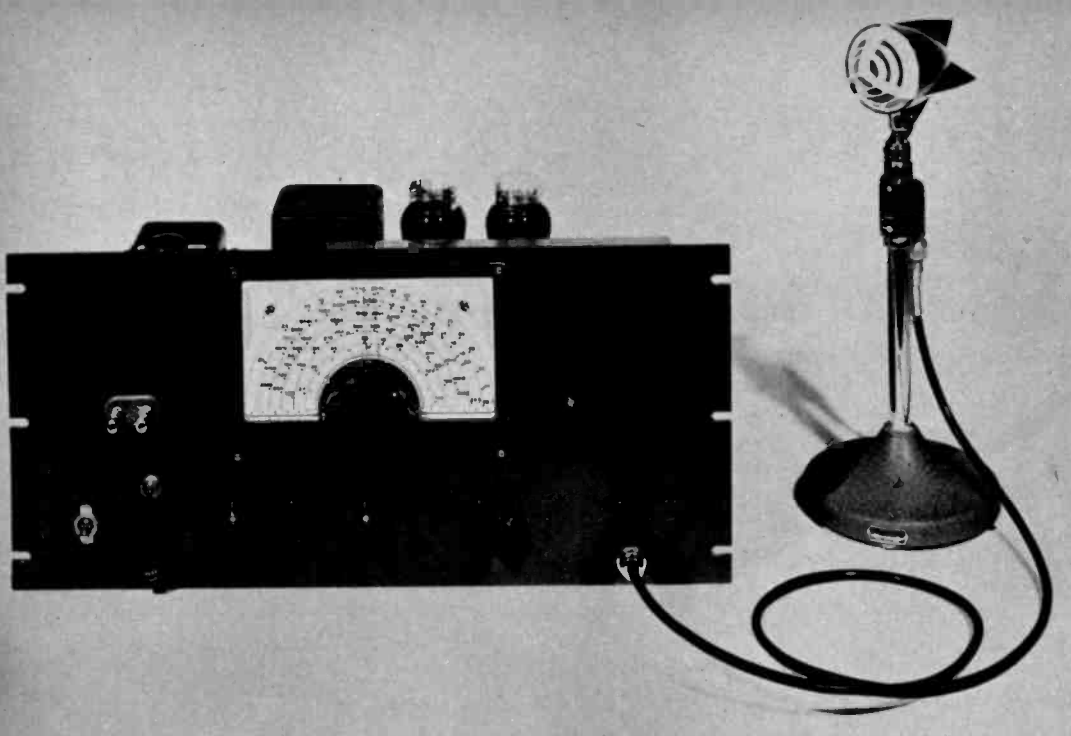

Figure 24.
**FRONT VIEW OF THE AUDIO
OSCILLATOR AND SPEECH
AMPLIFIER.**

The controls on the front panel reading from left to right are: a-c line switch, low-level audio output terminals, low-level audio output attenuator, audio-oscillator/speech-amplifier switch, main output control and gain control for use as a speech amplifier, range switch, and in the lower right-hand corner is the microphone jack.

quency. The other half cycle of the 60-cycle line wave is blanked out by the phase-shift circuit comprised by C_2 and R_7 . The single-trace time base operates in the following manner: A-c voltage is taken from the secondary of the power transformer T by a voltage divider comprised of R_1 and R_2 . This voltage is used for horizontal deflection on the cathode-ray tube and the ratio of these two resistors determines the amplitude of the sweep as seen on the face of the tube. However, a portion of this voltage is also shifted approximately 90° in phase by C_2 and R_7 and then supplied to the grid of the cathode-ray tube. Since the voltage on the grid leads the horizontal deflection voltage by 90° , the action of the grid allows the electrons to pass through the electron gun and on to the viewing screen when the deflection voltage on the horizontal plates is causing the spot to sweep from left to right. However, when the voltage on the deflection plates is such as to cause the spot to sweep backward from right to left the electron stream is stopped and the spot is blanked off the screen by the

fact that a high negative potential is acting on the grid of the cathode ray tube.

Through the use of this single-trace circuit the usual "doubling up" of the image which is obtained when using sine-wave a.c. on the horizontal plates is eliminated. The effect of this sweep circuit is to give the same desirable result for monitoring of an amplitude modulated transmitter as is obtained when a separate sweep generator and sweep amplifier with the associated tubes and power supply is employed. The 60-cycle horizontal sweep rate obtained through the use of this circuit is just about optimum for visual monitoring of male speech modulation of an AM transmitter.

The unit is constructed in a Bud no. 1124 rectangular box without the aid of an additional chassis. All components are mounted directly upon the walls of the container. Note that a power transformer especially designed for operation of a cathode-ray oscilloscope has been employed. This procedure is strongly to be recommended since the induction field in the

Figure 25.
**REAR VIEW OF THE OSCIL-
LATOR WITH COVER IN
PLACE.**

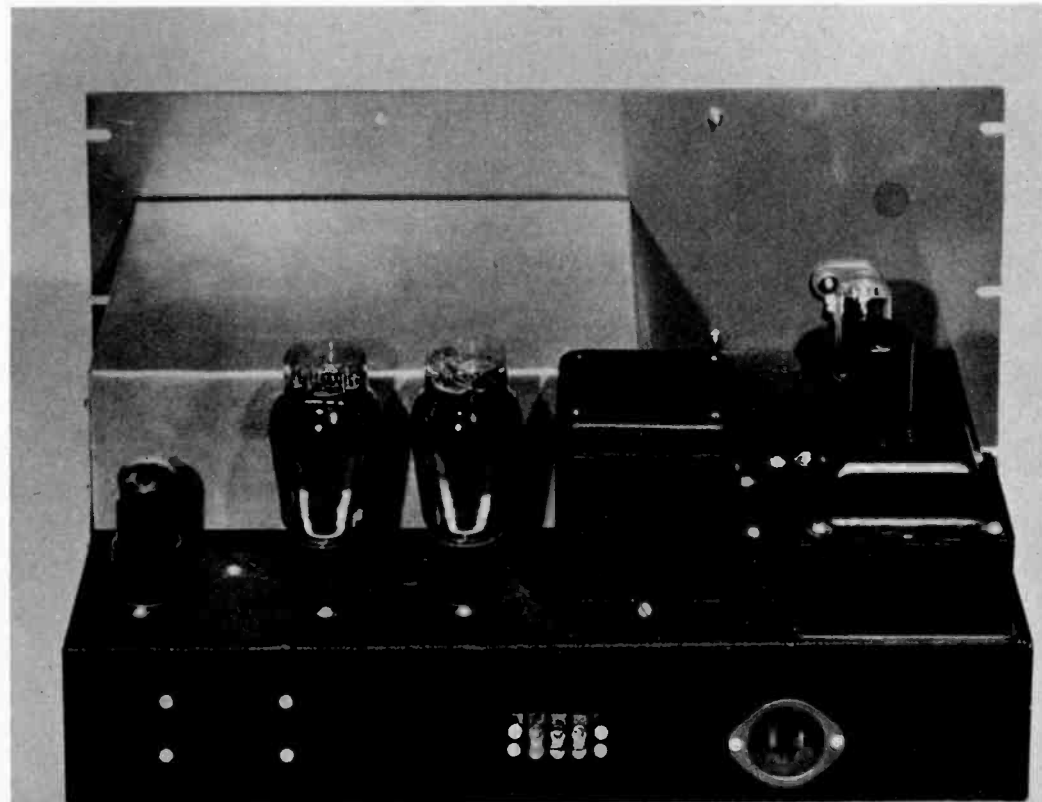
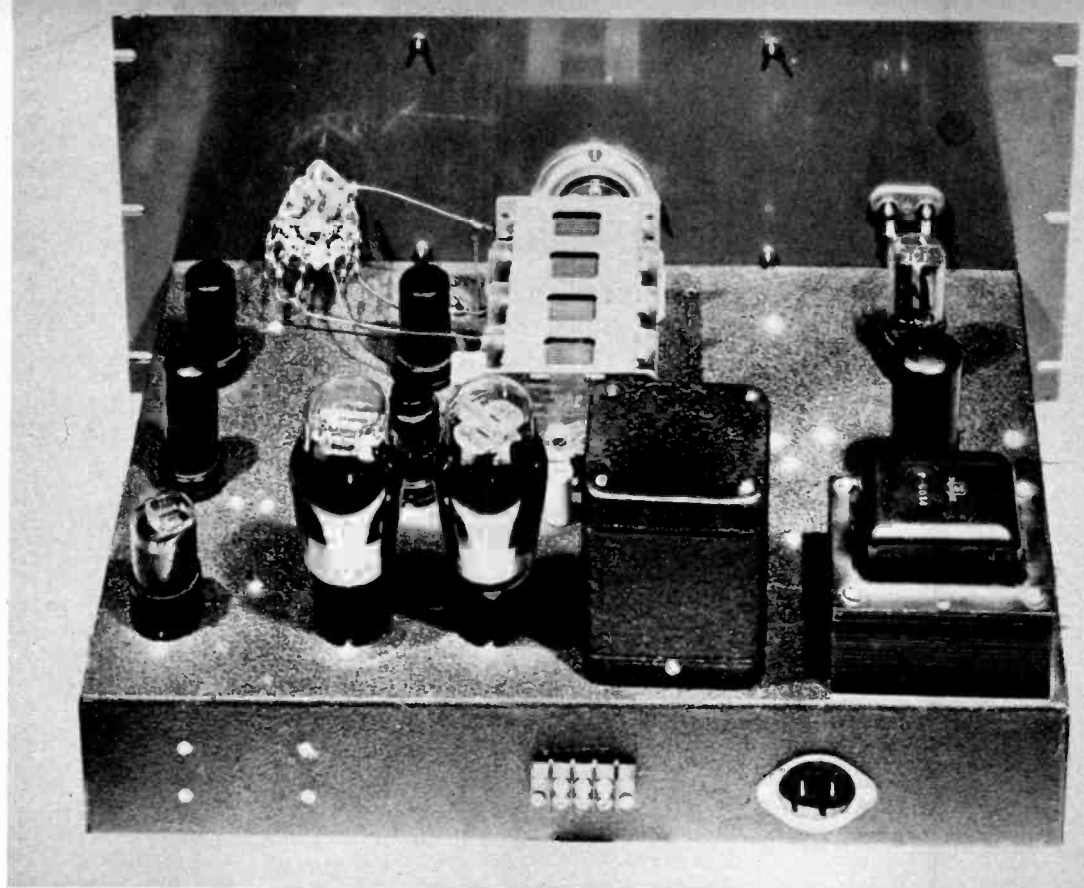

Figure 26.
REAR VIEW OF THE OSCILLATOR WITH SHIELD COVER REMOVED.

Note the four-gang tuning capacitor and the range resistors mounted upon the range switch.



vicinity of a conventional receiver power transformer is so strong as to cause undesirable electromagnetic deflection of the beam in the associated cathode-ray tube unless the transformer is mounted several feet distant. With a special c-r tube transformer such as has been used no additional magnetic shield is required around the cathode-ray tube. Two commercially available transformers which may be used with an oscilloscope of this general type are the Peerless R-5213Q and the Thordarson T-14R32.

Adjustment Adjustment of this unit is quite simple once the assembly has been completed. It is necessary only to throw S_2 to the internal-sweep position and then adjust R_1 and R_2 until a satisfactory time base without blurring or fuzziness is obtained. If the sweep amplitude is improper it may be adjusted by variation in the ratio of R_1 to R_2 . If the brightened portion of the sweep is not in the center of the

face of the tube, proper phasing of the time base and consequently proper centering can be obtained by adjustment of the values of C_2 and R_3 .

AUDIO OSCILLATOR AND TEST AMPLIFIER

A wide-range audio oscillator is a necessity both in the laboratory and in the amateur station when any degree of audio amplifier or phone transmitter testing is to be done. In addition it has been found that an audio amplifier with a power output of 10 to 15 watts is invaluable for making voice and music checks on a transmitter, a high-power audio amplifier, or a loudspeaker system. The unit shown in Figures 24, 25, and 26 and diagrammed in Figure 28 is a combination equipment that fills both the above needs. It covers the audio frequency and low radio frequency range from 20 cycles to 100,000 cycles with a power output of 15 watts maximum.

Figure 27.
UNDERCHASSIS VIEW OF THE AMPLIFIER/OSCILLATOR

The small Jones strip on the rear of the chassis is for high-level (up to 15 watts) audio output. Note the two 6-watt tungsten lamps near the front panel and just to the left of the center of the chassis.

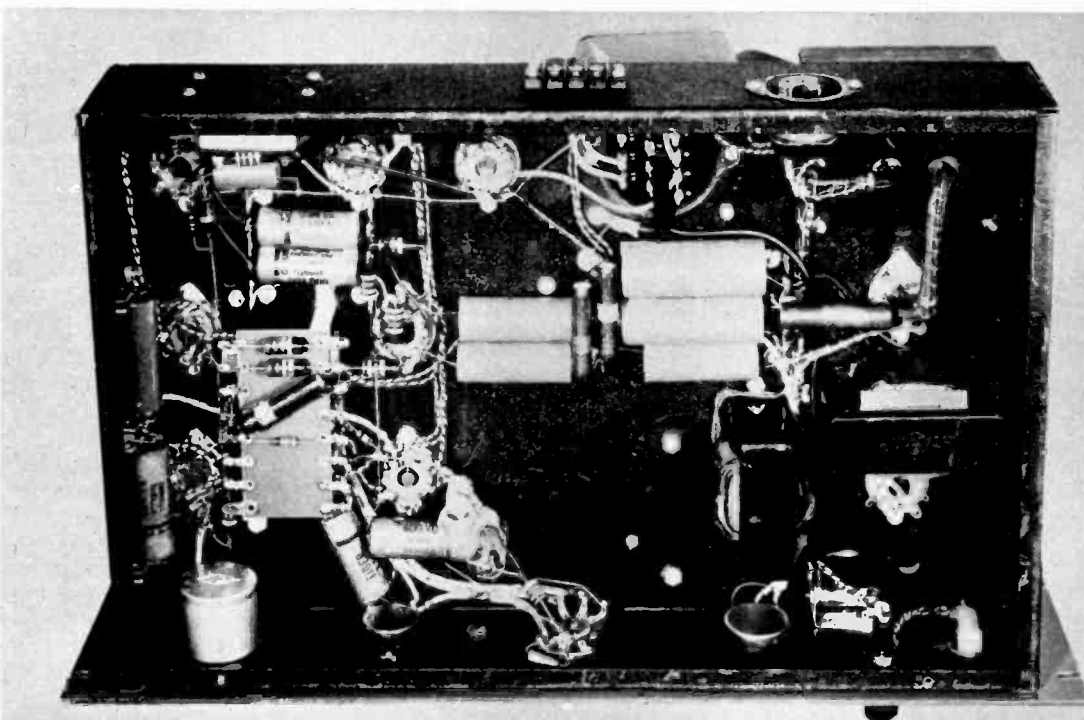

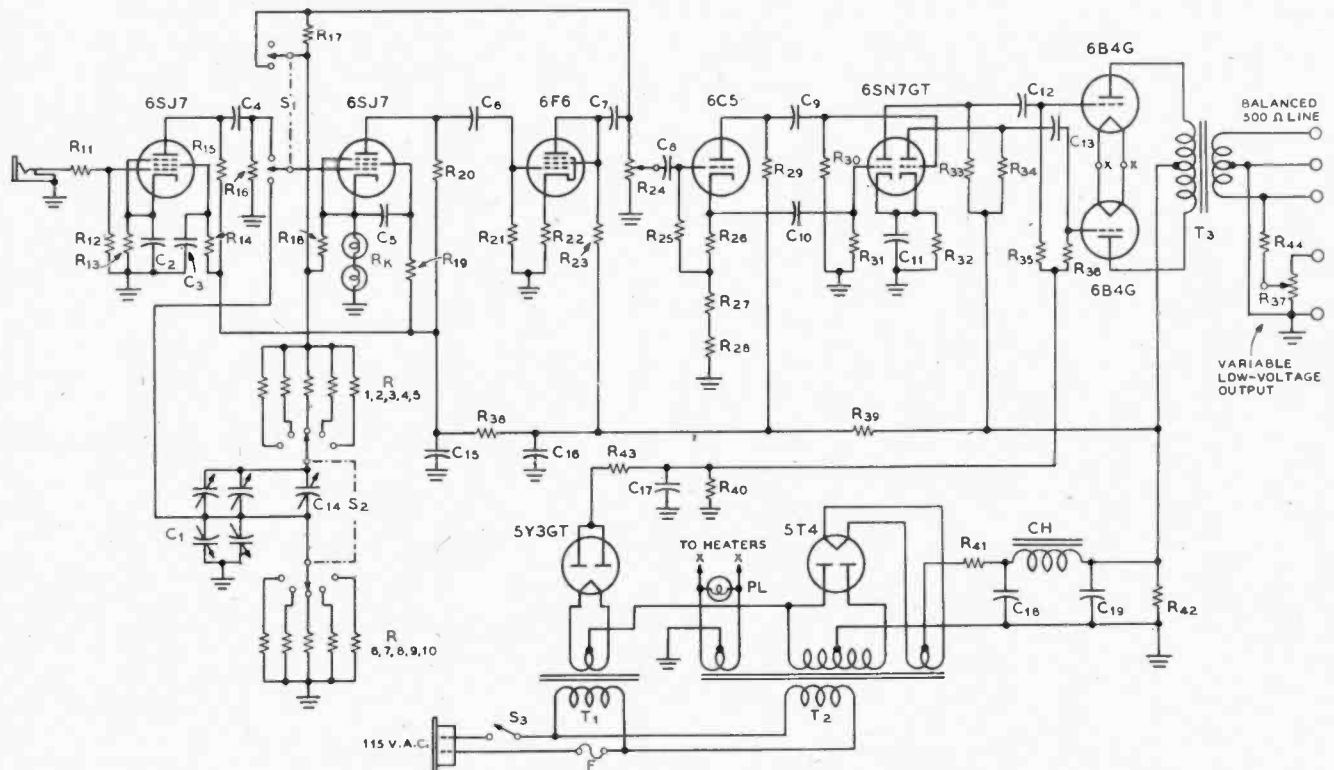

Figure 28.

SCHEMATIC DIAGRAM OF THE AUDIO OSCILLATOR/TEST AMPLIFIER

- | | | | |
|--|--|---|--|
| C ₁ —4-gang 365- μ fd. broadcast-type tuning capacitor | C ₁₁ —40- μ fd. 150-volt elect. | R ₃₀ —100,000 ohms 1/2 watt | R ₄₁ —500 ohms 20 watts |
| C ₂ —25- μ fd. 25-volt elect. | C ₁₀ —16- μ fd. 500-volt elect. | R ₃₁ —470,000 ohms 1/2 watt | R ₄₂ —50,000 ohms 20 watts |
| C ₃ —0.25- μ fd. 400-volt tubular | C ₁₉ —16- μ fd. 450-volt elect. | R ₃₂ —220 ohms 2 watts | R ₄₃ —18,000 ohms 10 watts |
| C ₄ —0.02- μ fd. 400-volt tubular | R ₁ , R ₀ —10 megohms 1/2 watt | R ₃₃ —12,000 ohms 2 watts | R ₄₄ —10,000 ohms 2 watts |
| C ₅ —0.25- μ fd. 400-volt tubular | R ₂ , R ₇ —1.8 megohms 1/2 watt | R ₃₄ —1.0-megohm potentiometer | T ₁ —5 volts 3 amperes |
| C ₆ —8- μ fd. 450-volt elect. | R ₃ , R ₈ —330,000 ohms 1/2 watt | R ₃₅ —470,000 ohms 1/2 watt | T ₂ —750 c.t. 150 ma., 5 v. 3 a., 6.3 v. 5 amperes |
| C ₇ —8- μ fd. 450-volt elect. | R ₄ , R ₉ —62,000 ohms 1/2 watt | R ₃₆ —470 ohms 2 watts | T ₃ —3000 ohms plate-to-plate to 500-ohm line, 15 watts |
| C ₈ , C ₉ , C ₁₀ —0.1- μ fd. 400-volt tubular | R ₅ , R ₁₀ —12,000 ohms 1/2 watt | R ₃₇ —1000 ohms 2 watts | CH—7.0 henrys at 150 ma. |
| C ₁₁ —25- μ fd. 25-volt elect. | R ₆ , R ₁₁ —47,000 ohms 1/2 watt | R ₃₈ —1800 ohms 2 watts | S ₁ —D.p.d.t. switch |
| C ₁₂ , C ₁₃ —0.1- μ fd. 400-volt tubular | R ₁₂ —1.0 megohm 1/2 watt | R ₃₉ , R ₄₀ —470,000 ohms 1/2 watt | S ₂ —2-pole 5-position switch |
| C ₁₄ —75- μ fd. compression trimmer capacitor | R ₁₃ —1800 ohms 2 watts | R ₄₁ , R ₄₂ —47,000 ohms 1/2 watt | S ₃ —S.p.s.f. toggle switch |
| C ₁₅ , C ₁₆ —8- μ fd. 450-volt elect. | R ₁₄ —1.0 megohm 1/2 watt | R ₄₃ , R ₄₄ —1000-ohm potentiometer | R _L —GE Mazda S-6 6-watt 115-volt lamps |
| | R ₁₅ , R ₁₆ —470,000 ohms 1/2 watt | R ₄₅ —47,000 ohms 1/2 watt | |
| | R ₁₇ —4700 ohms 2 watts | R ₄₆ —47,000 ohms 2 watts | |
| | R ₁₈ —1800 ohms 2 watts | R ₄₇ , R ₄₈ —10,000 ohms 10 watts | |
| | R ₁₉ —470,000 ohms 1/2 watt | | |

Alternatively, by throwing a single switch the unit may be used as an audio amplifier having sufficient gain to obtain full power output with its input fed from a phonograph pickup or any common type of microphone.

The Circuit It is necessary to add only a comparatively small number of components to make an audio oscillator of the RC bridge type from an audio amplifier. Conversely, it requires only the addition of a switch and a 6SJ7 pre-amplifier stage to make an audio amplifier from an a-f oscillator.

The audio oscillator circuit is more or less conventional using a 6SJ7 and a triode-connected 6F6 in conjunction with the usual 4-gang broadcast variable capacitor and a group of resistors. Two 6-watt 115-volt lamps are used as nonlinear regulating impedances in the feedback path. Capacitor C₁₁ acts as a balancing capacitance to compensate for the additional capacitance to ground of the rotor of the tuning capacitor. The adjustment of C₁₁ for constant output over the tuning range is a fairly critical adjustment in the audio oscillator circuit but needs to be made only once.

The power amplifier portion of the unit also is quite conventional, using a hot-cathode 6C5 phase inverter followed by

a push-pull 6SN7 stage and a pair of 6B4G's operating with fixed bias. The full rated output of this tube type of 15 watts can be obtained with very low distortion. The output of the 6B4 stage is fed to a 500-ohm line for the purpose of driving a high power Class B modulator or a loudspeaker system. In addition a variable low level output terminal has been provided for the testing of low-level audio amplifiers.

Note that an aluminum shield can has been placed over the oscillator tuning capacitor and the frequency-determining resistors and range-change switch. The low-level amplifier stages are also inside this shield can, although this was not necessary except in that the construction of the metal shield was simplified by making it a simple rectangular shape.

The adjustment of resistor R₁₁ for pure waveform over the entire frequency range is moderately critical and should be made with the aid of an oscilloscope. However, once it has been made it need not be changed unless the 6-watt lamps in the feedback circuit are changed for some reason. The resistor R₁₇ is switched into the circuit when the audio oscillator is changed over to operation as an amplifier to reduce the effect of the variable resistance lamps. The value of this resistor may be decreased to obtain a small amount of volume compression in the speech amplifier if desired.



Conversion of Surplus Equipment

AS every amateur well knows, there are and have been excellent bargains available in surplus military electronic equipment. Also, as many purchasers are discovering, many items which appear to be bargains are in reality more of the nature of headaches which may best be dis-assembled for components and the balance junked. In a case like this, when a tally is made of the value of the directly usable components it is very frequently found that a group of more flexible standard-brand components could have been obtained from a regular supply house for less expenditure.

So be wary in the buying of surplus items. Unless the unit is immediately usable in substantially complete form, it is well to assess an item in terms of the components which it contains that are immediately usable. All too frequently it will be found after careful evaluation that an item would not be a bargain at a price even lower than that asked.

In this chapter are given detailed instructions in some cases, and hints in others, on the utilization of certain surplus items which have proven to be good values. An exception, perhaps, is the BC-375 or BC-191 equipment, which defies satisfactory utilization in the original form. But if such an equipment is already on hand or can be obtained for a sufficiently low price, an acceptable modulator with 120 to 140 watts of output can be constructed in the chassis of the original unit with the audio transformers which it contained.

THE BC-312 AND BC-342 SERIES RECEIVERS

The BC-312 and BC-342 series receivers are, without modification, acceptable communications receivers. However, their performance can be greatly improved for amateur communication work by making certain modifications in various portions of the receiver. Any one of the changes or all the changes may be made, each change adding a certain amount to the performance and flexibility of the receivers. The various changes

will be treated separately so that any one or all the changes may be made at the discretion of the owner of the receiver.

Power Supply for the BC-312 If the receiver is a BC-312, a power supply must first be constructed. The BC-342 is equipped with an integral 115-volt power supply but the BC-312 has a 12-volt dynamotor in place of the a-c power supply of the BC-342. Otherwise the receivers are substantially identical. It will be assumed throughout this and subsequent discussions that the owner of the receiver has a copy of TM 11-850 or one of the other instruction books on this series of receiver since these instruction books were furnished with the receivers or were generally available at the time the receivers were sold.

The dynamotor must first be swung out on its hinges, and then the leads from the dynamotor to the 9-terminal connection strip removed. A power supply such as shown in Figure 1 and diagrammed in Figure 3 must then be constructed. The one illustrated employs a Signal Corps C-228 power transformer, which is the same one as was used in the RA-20 power supply for the BC-342. A large number of these power transformers have been available, but if one cannot be obtained, any power transformer having a 650-volt to 750-volt center-tapped high-voltage winding, a 5-volt filament winding for the 5Y3-GT, and one or two 6.3-volt filament windings at 1.75 amperes or greater will be satisfactory. If the transformer has two 6.3-volt filament windings (such as the UTC type R-12) they are connected in series to obtain the 12.6 volts necessary for heater operation of the receiver. If the transformer has only one 6.3-volt winding an additional very small 6.3-volt 2-ampere filament transformer must be placed in the power supply and connected in series with the 6.3-volt winding on the main power transformer to obtain the 12.6 volts. The junction between the two 6.3-volt filament windings should be grounded in the power supply.

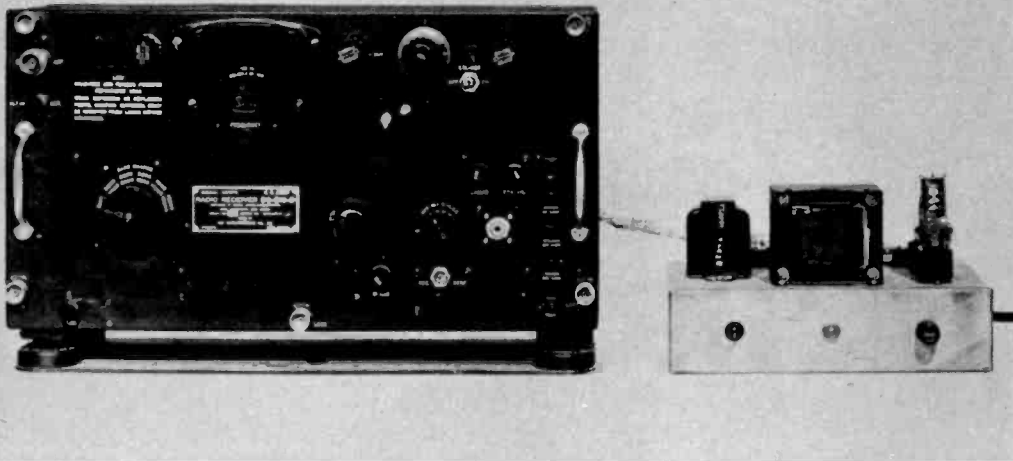

Figure 1.
FRONT VIEW OF THE CONVERTED BC-312 RECEIVER WITH THE POWER SUPPLY ALONGSIDE.

The coaxial i-f energy output fitting can be seen on the panel in the position formerly occupied by the power connector. The switch mounted at the bottom of the vertical row of jacks is the noise-limiter on-off switch. The power supply is normally mounted remotely from the receiver and controlled by the OFF-MVC-AVC switch.

One complication is introduced by the fact that the dial-lamp circuit uses two 6.3-volt lamps in series to ground, so that if the lead to the dial lamps is connected to either of the hot 6.3-volt filament leads the lamps will only receive half voltage. This may be satisfactory, since the lamps give adequate light at this voltage, or the two lamps may be connected in parallel by removing the bezel that covers the two lamps and rewiring them.

The balance of the power supply is quite conventional. The VR tube shown in Figure 3 need not be used unless desired, but its use does afford improved oscillator stability.

Voltage Regulation for H-F Oscillator.

The high-frequency oscillator used in the receiver is quite stable, but when operating on the 14-Mc. band there is some variation in the tone of a c-w signal when the r-f gain is varied, or when the line voltage varies as a result of a household refrigerator turning on or off or from some similar cause. This condition is cured by using voltage regulation on the plate supply voltage to the high-frequency oscillator. The incorporation of voltage regulation on the oscillator requires that a lead be brought out of the oscillator compartment for separate plate-voltage feed to the tube. This operation requires removal of the cover from the oscillator compartment, and the removal of 30,000-ohm resistor R_{11} . This resistor is replaced by a 1000-ohm $\frac{1}{2}$ -watt carbon resistor. The r-f stage chassis is then lifted back, after removing the leads to the tube caps, and the plate-voltage terminal coming out of the oscillator compartment is by-passed with a 0.002- μ fd. postage-stamp mica capacitor which can be placed flat against the chassis below the terminal strip. The lead for plate voltage to the oscillator is then brought under the r-f chassis and down through the hole where the other leads feeding the r-f chassis pass. This plate-voltage lead then goes, of course, to the plate of the VR-105.

R-F Changes The r-f system in the standard receiver is slightly lacking in gain and signal-to-noise ratio on the highest frequency range. This condition can be checked by removing the antenna lead from the receiver, turning the receiver wide open on MVC, and then rotating the trimmer APC on the first r-f stage through resonance. Only a very slight increase in noise level will be noticed when this trimmer passes through resonance.

The most satisfactory way of correcting this condition (and this method was proven best after trying a number of other expedients) is to replace the 6K7 first r-f stage with a 6SH7. It so happens that the receiver is laid out in such a manner that a single-ended tube in the first r-f stage gives much more direct leads than the double-ended tube originally used. The procedure is as follows:

Remove the tubes from the r-f chassis and invert the chassis as far as possible. Remove the leads from pins 3, 4, 5, 6, and 8 of the tube socket for the first r-f stage. Remove the old cathode-bias resistor RS-164. Run a 100-ohm 1-watt resistor from the small micarta terminal block for the MVC lead to pin 5, and also run to pin 5 a lead from the cathode by-pass section of the capacitor block for the stage. Install an additional 0.002- μ fd. postage-stamp mica capacitor as a cathode-by-pass from terminal 3 to terminal 1. Separate the screen-voltage lead that went to terminal 4, shorten it until it fits more neatly and solder to pin 6. Now run the plate lead for the tube, which did go to terminal 3 and run it *under* all the wires near the heater end of the socket and connect this lead to terminal 8. Remove the lead which went to the grid cap of the 6K7, solder a wire about $1\frac{1}{2}$ inches long to this terminal on the main chassis, push the sub-chassis down as far as it can go and still reach terminal 4 on the tube socket with a soldering iron, and solder this new lead to terminal 4. Then push the chassis back into place gently, at the same time making sure that the grid lead to the tube (terminal 4) keeps free of the chassis and bends out toward the ganged tuning capacitor.

It will now be necessary to re-align the r-f stages of the receiver slightly (*not* the h-f oscillator however). Peak up the 6L7 mixer stage first, then the second r-f stage, and then the first r-f stage. The gain will be found to be much greater than before, and the increase in noise when the first r-f stage is trimmed through resonance will be found to be very pronounced. If a tendency toward instability is encountered near maximum gain on MVC, re-trim the *mixer* stage padders slightly until the instability disappears.

All these receivers have a certain amount of backlash in the vernier tuning control. In several receivers the amount of backlash has been reduced to a very small amount by carefully lubricating all the gears with a small amount of vaseline, using a toothpick or a matchstick to apply the lubricant. Then the backlash, which in the receivers mentioned was caused by axial motion of the tuning-capacitor gang, can be substantially eliminated by careful adjustment of the ball thrust bearing at the *oscillator* end of the tuning gang. This bearing is inside the oscillator compartment.

I-F Amplifier Changes

The i-f amplifier operates quite satisfactorily, but the action of the crystal filter leaves much to be desired. The reduction in set gain when the crystal filter is switched into operation can be greatly reduced by the following procedure: Remove the cover from the crystal-filter transformer. Scrape the stud which serves as a stop for the rotation of the crystal-phasing capacitor and solder a very small wire to this stud and to the small switch contact on the other side of the phasing capacitor. Then turn the phasing control until the moving contact rests firmly

Figure 2.
UNDERCHASSIS VIEW OF THE RECEIVER AND POWER SUPPLY.

The bent-aluminum chassis holding the 7A6 noise limiter tube can be seen behind the power-cable receptacle. The added chassis is mounted to the front panel.

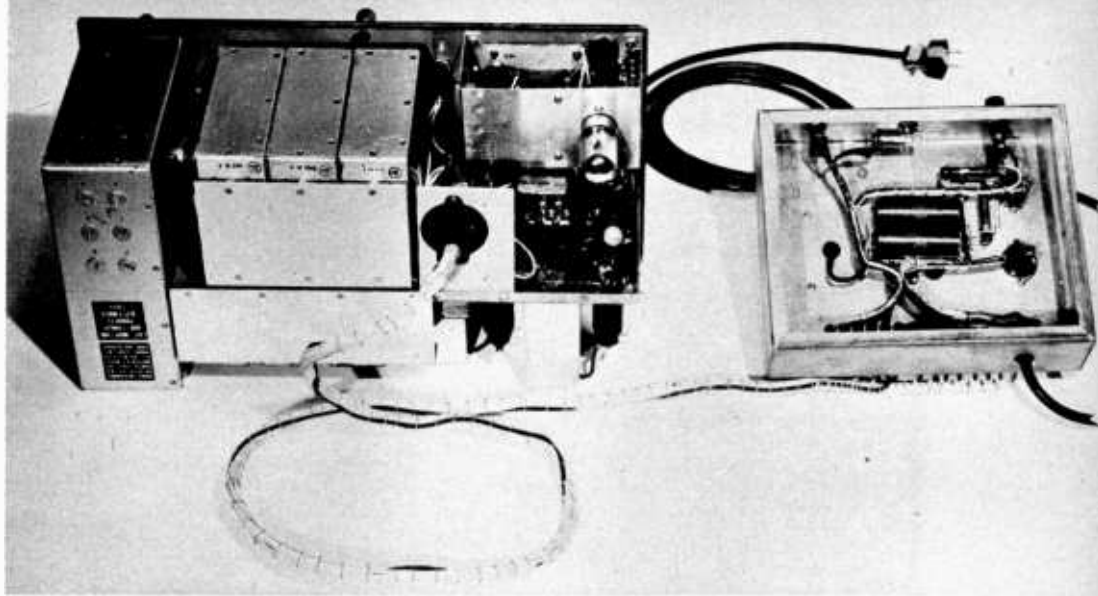

against the stud. Re-install the cover of the transformer and align the slug which comes out of the top of the crystal-filter transformer for maximum noise with the antenna removed from the receiver. This position of the control (180° from the old position) now serves as the crystal-out position, and the reduction in gain when the crystal filter is switched into the circuit will be very small.

A further change in the i-f amplifier was made in the receiver shown in Figure 1 to bring out i-f energy for the operation of external devices such as a panoramic adapter, a narrow-band FM adapter, or another external unit such as a single-sideband channel. The change consisted in merely wrapping 7 turns of hookup wire around the form between the two i-f coils inside the last transformer, connecting one side of this coil to ground and the other side to the center conductor of a

piece of RG-58/U cable. The cable is brought into the transformer by first removing the black wire going into the transformer and grounding the capacitor to a soldering lug under the screw adjacent to the terminal from which the black wire was removed. It may be necessary to ream the hole from which the black wire was removed slightly in order to be able to insert the insulation and the inner conductor of the coaxial cable. The outer conductor of the coaxial cable is grounded outside the transformer. The coupling connector for the coaxial cable was mounted on the front panel of the receiver in the position formerly occupied by the power-cable connector, which had previously been removed.

With the i-f energy obtained from the panel coaxial connector coupled to an external coil resonated to the intermediate frequency by means of a small 7-turn coupling coil, approximately 10 volts peak was measured with a normal signal input and the receiver operating on AVC. With the receiver on MVC, more than 50 volts peak could be obtained. This voltage is of course quite adequate to operate any of the accessories mentioned in the previous paragraph.

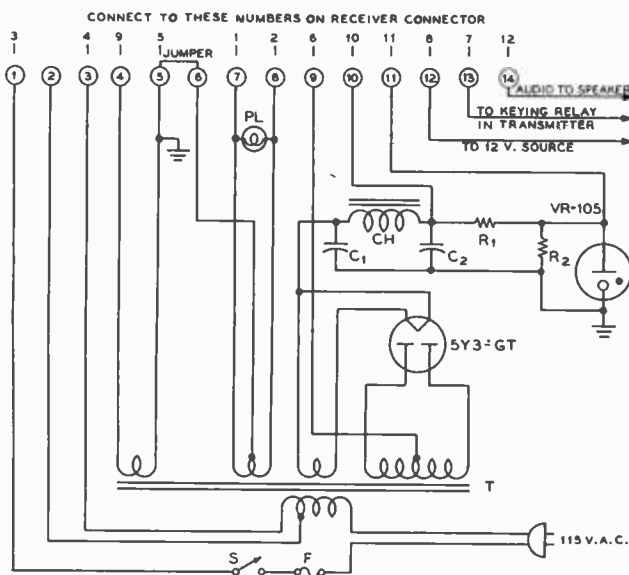

POWER TRANSFORMER COLOR CODE: RED = 110 VOLTS COMMON, BLACK = 120 VOLTS
FOR C-228 TYPE GREEN = 105 VOLTS
BROWN = 12 VOLTS, NO C.T.
BLUE = 12 VOLTS, SLATE WITH TRACER = C.T.
BLACK = H.V., YELLOW = C.T.

Figure 3.

SCHEMATIC DIAGRAM OF THE POWER SUPPLY UNIT.

The color code shown at the bottom of the drawing is for the C-228 power transformer which may be available. If this transformer is not available a conventional power transformer having two 6.3-volt windings may be used as described in the text.

C₁, C₂—16-μfd. 450-volt elect.
T—700 v. c.t. 100 ma.; 5 v. 3 a.; 6.3 v. 3 a., 6.3 v. 3 a. in series with center grounded. Or 12.6 v. ct.

CH—15 henrys 100 ma.
R₁—12,500 ohms 10 watts
R₂—100,000 ohms 2 watts
S—S.p.s.t. a-c line switch
F—3-ampere fuse

Audio System Changes

The audio system of the 312 and 342 receivers leaves much to be desired. There is inadequate gain for reception of weak signals on crystal filter, the frequency response is quite poor (though intentionally so for military use), and the harmonic distortion is severe. All these undesirable conditions were overcome by the relatively simple change in the audio system shown in Figure 4. A 6B8 diode-pentode was used to replace the 6R7 diode-triode previously used, and the 6F6 was replaced with a 6V6. Shunt feedback from the plate of the 6V6 to the plate of the pentode section of the 6B8 was used to improve the frequency response and reduce harmonic distortion. Also, the feedback almost completely eliminates the hum in the audio system of these receivers. The cathode resistors for the two stages were left the same, but an additional 25-μfd. 25-volt electrolytic was placed across the cathode resistor of the 6B8 so that the gain control would completely cut off the audio output when turned clear down in the AVC position.

The audio transformer that was used in the plate circuit of the 6R7 is removed from the circuit but was left in place since the space was not required and it appeared to be difficult to remove. When a noise silencer, to be described later, is to be used in receivers of the BC-342 series, it would probably be best to remove this transformer and install the noise limiter tube in the place formerly occupied by the transformer, since the presence of the power supply inside the receiver will preclude installing the noise silencer in the place shown in the photograph of the BC-312.

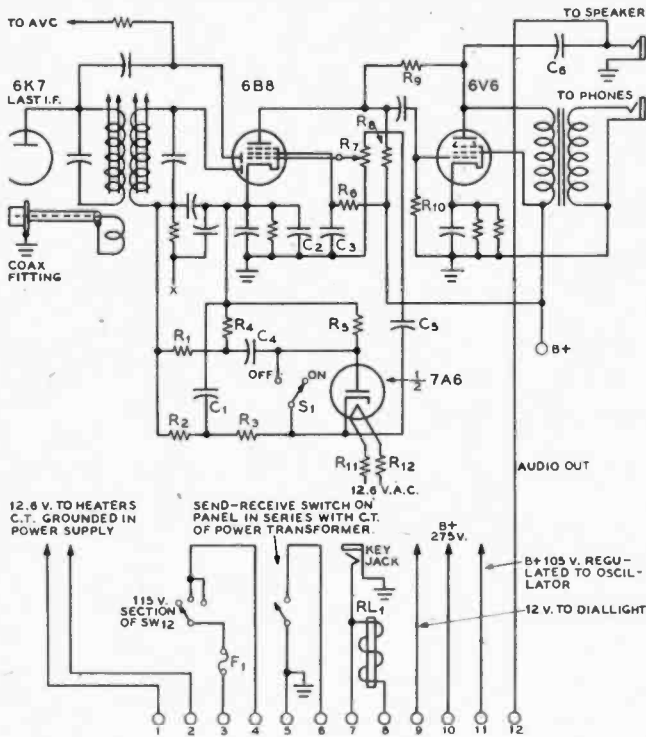

Figure 4.
CHANGES IN THE BC-312 RECEIVER.

Unmarked components are already in the receiver and need not be removed or replaced.

- | | |
|--|---|
| C ₁ —0.1- μ fd. 400-volt tubular | R ₁ , R ₂ —470,000 ohms 1/2 watt |
| C ₂ —25- μ fd. 25-volt elect. | R ₃ —1.0 megohm 1/2 watt |
| C ₃ —0.1- μ fd. 400-volt tubular | R ₄ —1.0-megohm potentiometer |
| C ₄ —0.05- μ fd. 400-volt tubular | R ₅ —220,000 ohms 1/2 watt |
| C ₅ —0.01- μ fd. 400-volt tubular | R ₆ , R ₁₀ —470,000 ohms 1/2 watt |
| C ₆ —8- μ fd. 450-volt elect. | R ₇ , R ₁₂ —22 ohms 2 watts |
| R ₁ —100,000 ohms 1/2 watt | RL ₁ —Relay inside receiver |
| R ₂ , R ₃ —1.0 megohm 1/2 watt | |

If desired, the volume control and gain control system can be left unmodified, in which case the green wire coming from S₁₂ is removed from the bottom end of R₁₀ on the Group 1 terminal board on the right outside wall of the chassis and run to the noise silencer. The grid leak on the power audio tube R₃ is removed and changed to a 470K 1/2 watt. Capacitor C₄ has been added to couple to a conventional 5000 to 8000 ohm output transformer on the external loudspeaker. The impedance ratio of T₂ inside the set is 7:1 so that an impedance of about 1000 ohms is required on the speaker transformer if the audio output is to be taken through transformer T₂. Due to the voltage step down in T₂ the secondary of this transformer was used to feed the phones. The 60-ohm filament current equalizing resistor R₄ should be removed, and if a 7A6 is used as noise limiter its heater should be placed across the heater of the 6V6-GT. In any event it is wise to ground terminal 7 of the socket for the 6B8 to insure that all the tubes will be operating at proper heater voltage.

Noise Silencer The noise silencer shown in Figure 4 has been found to be very effective on the 14-Mc. band, and on the 28-Mc. and 50-Mc. bands when a converter is used ahead of the receiver. One half of a 7A6 tube has been used, and since this tube draws only 150 ma. of heater current the heater may be fed with a balance to ground by means of two 22-ohm 2-watt carbon resistors from the 12.6-volt heater line. Or, if desired, the heater may be placed in parallel with the 6V6-GT heater as discussed in the previous paragraph. One half of a 6H6 or 6AL5 tube could also be used for the noise

limiter, but these latter tubes require 300 ma. of heater current. It is possible that a 12H6 could also have been used, but one has not been tried. Make sure that the return for the noise limiter (the bottom end of C₁, R₅ and R₁) is made to the cathode of the 6B8 and not to ground—if the return is made to ground proper noise-limiting action will not be obtained. A switch S₁ has been provided to take the noise silencer out of the circuit, since the circuit does introduce a detectable amount of distortion on a short-wave broadcast program.

Gain Control Changes It is a convenience in a communications receiver to have a separate control for audio and r-f gain. To accomplish this in the series of receivers under discussion it is suggested that the dual control at the top of the panel be replaced by a single 1/2-megohm audio-taper potentiometer. C₁₁ and R₁₂ are removed, and the low-potential end of the audio gain control is returned to ground. The r-f gain control lead can be pulled down to the underside of the chassis and connected to a separate 15,000-ohm r-f gain taper rheostat which can be placed either in the position formerly occupied by the MIKE jack or just to the right of the SEND-RECEIVE switch. The AVC position of the switch will still short out the r-f gain control in the conventional manner.

Control Circuits In the case of the BC-312 receiver as shown the 9-terminal power-connection strip was removed and the somewhat unsightly multi-connection receptacle on the front panel was removed and replaced by the "i-f output" coaxial receptacle. Power and control connections were brought out to a 12-contact Jones P-312-RP connector which was mounted by means of a bracket to the rear of the chassis. The receptacle was aligned with the hole which already exists on the rear of the cabinet housing. The connector on the end of the power cable is a Jones S-312-FHT. The key, shorting relay, and switch inside the receiver were then rewired to connections on the connector on the rear of the cabinet as shown in Figure 4. The switch is connected so that it is in series with the center tap of the power transformer. Since a 12-volt keying relay is used on the transmitter, the antenna-shorting relay inside the receiver was wired so that it closed every time the transmitter keying relay closed.

In modifying the BC-342 series of receivers the external control circuit connections for the transmitter can be brought out of the front panel by replacing the connector which is installed on the front panel by an Amphenol MIP-8 octal socket, which fits the same mounting holes.

HINTS ON THE BC-348 SERIES RECEIVERS

The BC-348 series of receivers are quite satisfactory for communications use in the amateur station, but as in the case of the BC-312/BC-342 series, there are several minor modifications which may be made to improve the performance and flexibility of the equipments.

BC-348Q General Information The BC-348 series of receivers may be operated with the heater circuits unchanged from a 26-volt a-c supply. But a power transformer with such a filament winding is not readily available (although the C-228 transformer mentioned in connection with the BC-312 may be used with the filament windings in series) so it is in most cases best to rewire the heaters for operation from 6.3 volts. This means that one side of the heater of each tube should be grounded and the other side should be brought out as a common for feeding from the 6.3-volt line. In many cases the original seriesing wires between tube sockets may be used either for the grounded side or the



Figure 5.
BC-348P RECEIVER, SPEAKER,
AND POWER SUPPLY.
The power supply is mounted in the
speaker housing.

hot side of the heater circuit, requiring addition of fewer wires and a solution to the problem of working in cramped spaces.

The a-c power supply for the receiver may be mounted in the space formerly occupied by the dynamotor if space considerations and portability are very important. However, this procedure is not desirable from the standpoint of ventilation since an a-c power supply dissipates a great deal more heat than the dynamotor originally installed. The space is more useful for additions to the receiver such as a noise limiter, an extra audio stage, or a broad-band converter such as described in Chapter 19.

The external a-c operated power supply may be made somewhat oversize for operation of a frequency meter or a converter or an additional station accessory. In this event it is desirable to be able to ground the negative lead of the plate supply, which is not done on the BC-348Q. It is necessary to change the bias circuits of the 6K6-GT audio stage and the 6SA7 converter to accomplish this. The first step is to ground the B minus and remove connections to choke 155-B and resistor 108-2. This leaves both the above stages unbiased. A 470-ohm 2-watt resistor should be placed in series with the cathode terminal of the 6K6-GT audio stage. A 25-volt 25- μ fd. electrolytic capacitor should be placed across this cathode resistor.

About 1.8 volts of bias is used on the grid of the 6SA7 converter stage. To obtain this, resistor 108-1 in the oscillator can be clipped out of the receiver. The contact at the junction of this resistor and resistor 87-2 is available as a projecting lug. Upon this lug may be mounted a standard

miniature bias cell with the positive side grounded and the negative side to the lug.

Audio Considerations in the BC-348Q

Addition of the noise-limiter circuit illustrated in Figure 29 of Chapter 5 will improve operation in the presence of ignition interference on the 14-Mc. band and is almost a necessity for use of the receiver with a converter on the 28-Mc. or 50-Mc. bands. The addition of an extra stage of audio is also desirable, especially for use with the crystal filter on 14-Mc. c.w. The added tube may be a 6SF5 triode with conventional circuit values chosen from the charts in Chapter 4, or a 6SJ7 stage with feedback may be added using the circuit given in Chapter 4 or shown in conjunction with the BC-312.

Difficulty may be encountered with the audio system of the receiver after the addition of the audio stage and the noise limiter due to the common cathode resistor on the second detector and the third i-f stage. This trouble may be avoided by isolating these two cathode circuits. The lead between the two cathodes is removed and resistor 105 is either removed or shorted. This leaves the third i-f stage with resistor 102 and capacitor 61-4 in its cathode circuit to ground. The cathode of the second-detector tube is now grounded to the chassis. The large capacitor can 70-A and 70-B may now be removed to make additional room inside the equipment. The 6- μ fd. section is ideal as a portion of the filter capacitance in the external power supply. The lead at the low-potential side of the third i-f transformer should be opened and the noise limiter inserted at this point. Capacitor 27-3 should be left to

Figure 6.
REAR VIEW OF THE BC-348P
ASSEMBLY.

Showing the power supply mounted in the speaker housing and the octal power plug on the receiver.

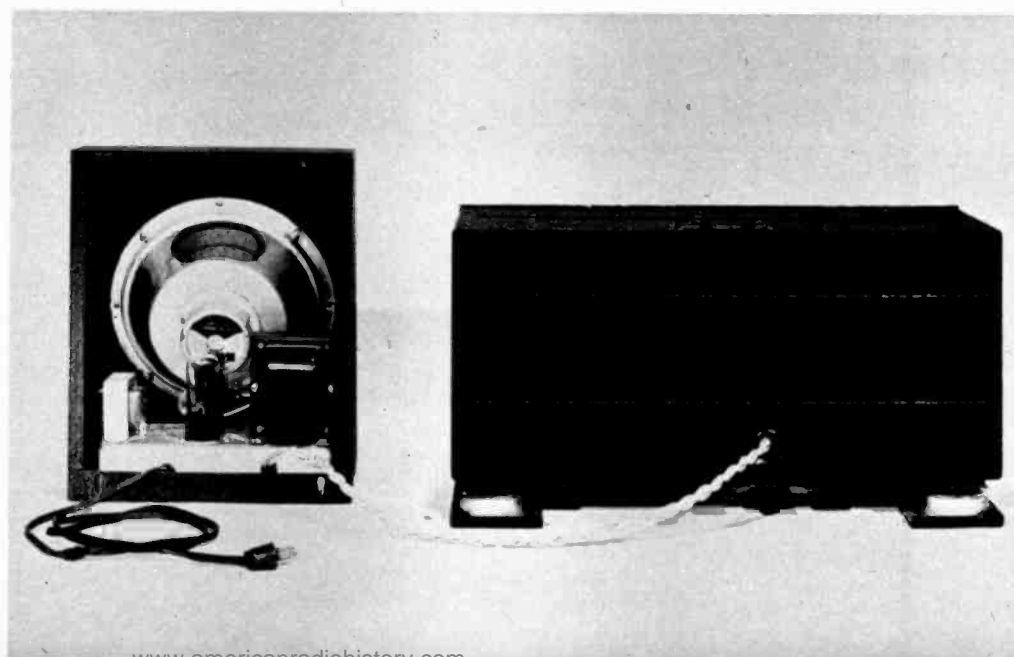

Figure 7.

MODULATOR AS MADE FROM A BC-375E.

The front cover has been removed to show the placement of components on the new chassis.

by-pass the secondary of the transformer as C_3 in Figure 29 of Chapter 5. The on-off switch for the noise silencer may be placed in a panel position in place of one of the headphone jacks.

Mechanical Considerations If a plug to fit the rear connector block cannot be secured, an octal socket may be fitted into the set by liberal use of a round file and then by drilling and tapping mounting holes for the socket. If the cast aluminum guide box is removed from the case it will not be necessary to enlarge the rectangular hole in the case to pass an octal power plug.

A socket punch may be used to make two holes in the back of the case. One hole is used to pass the plug for the speaker connection, and the other hole to reach a two-post terminal strip which is wired to the receiver silencing circuit (terminals 2 and 6 in the circuit diagram). These two terminals may then be shorted or wired into the transmitter control circuit in such a manner that the receiver is disabled whenever the transmitter is on the air.

The seriesed dial lamps should be paralleled and connected to the 6.3-volt heater circuit with the dial light control resistors 111 and 81 out of the circuit.

BC-348E, M, and P Receivers Changes in this series of receivers are generally the same as in the (J), (N), and (Q) series of 348's, except that only the power audio stage must be modified when grounding the negative lead of the power supply. Also, the second detector and third i-f stage cannot be isolated since they are in the same tube envelope.

Figures 5 and 6 show a convenient method whereby the power supply for a BC-348 series receiver may be mounted in the housing for the loudspeaker.

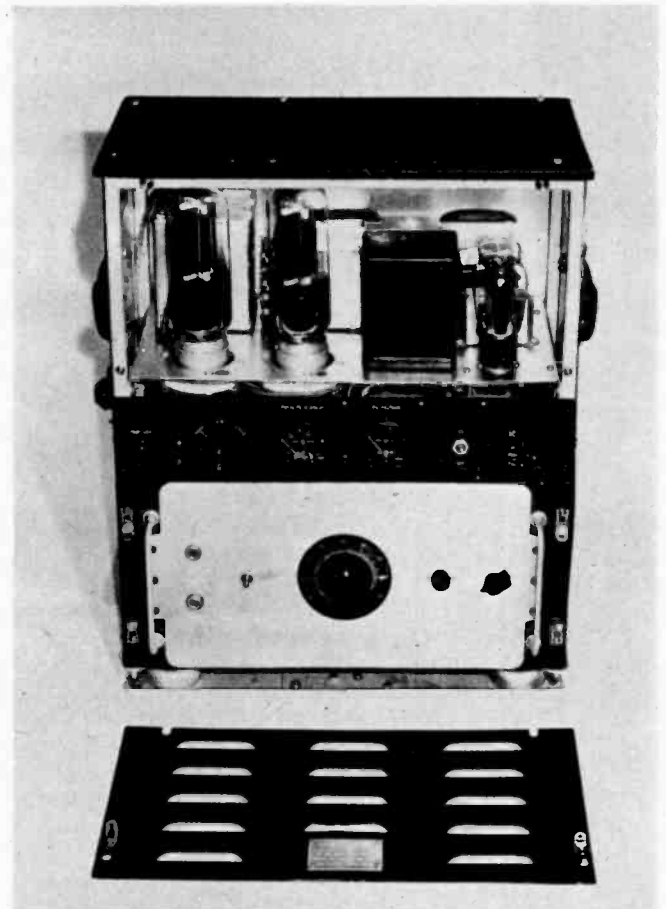
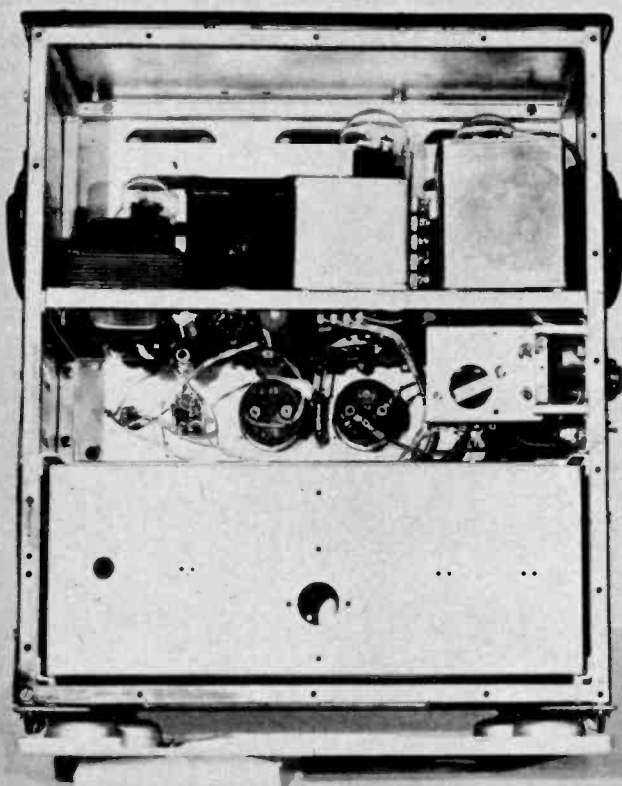

A 120 TO 140 WATT MODULATOR FROM THE BC-375 OR BC-191

One way in which to solve the problem of making good use of the BC-375E or the BC-191 is to dis-assemble the tuning drawers for components, use the housings for the tuning drawers as cabinets for accessory pieces of test equipment, and use the main housing of the transmitter along with the audio transformers and miscellaneous other components to assemble a modulator. Figures 7 and 8 show one such assembly which operates quite satisfactorily.

All components on the upper deck were removed, including the chassis, and a new chassis was bent from sheet aluminum to hold the components shown in Figure 9. The end of the main housing which held the antenna tuner was sawed off as unnecessary, but it might be retained to house the power supply for the modulator if components of the proper dimensions should be obtainable. The components mounted on the upper deck of the chassis include the power supply for the speech amplifier, a simple regulated bias circuit for the negative 100 volts on the 211 grids, and the audio transformers.

The clipper-filter audio amplifier and driver is mounted in the housing for one of the tuning drawers after all the r-f components had been removed. The circuit for the speech amplifier is shown in Figure 10. An additional panel was placed in front of the original panel to cover the multitude of holes that had been left by removal of the r-f components. The clipper-filter speech amplifier is quite conventional, ending in a single-ended 6B4-G which acts as driver for the 211's.

Figure 8.

REAR VIEW OF THE BC-375E MODULATOR.

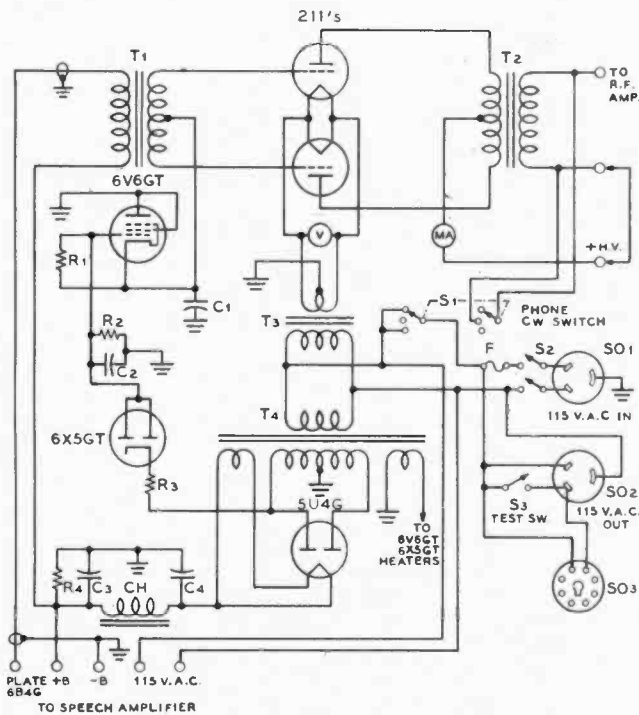

Figure 9.
MAIN ASSEMBLY SCHEMATIC OF THE BC-375E MODULATOR.

- | | |
|---|--|
| C ₁ —8- μ fd. 450-volt elect. | T ₁ —700 v. c.t. 90 ma., 5 v. 3 a., 6.3 volts 2 amperes |
| C ₂ —40- μ fd. 350-volt elect. | CH—12-hy. 90-ma. choke |
| C ₃ , C ₄ —8- μ fd. 450-volt elect. | MA—0-500 d-c ma. from 375E |
| R ₁ —100,000 ohms 1/2 watt | V—Voltmeter from 375E |
| R ₂ —7500 ohms 10 watts | S ₁ —Phone c-w switch from 375E |
| R ₃ —5000 ohms 10 watts | S ₂ —Main a-c line switch |
| R ₄ —50,000 ohms 20 watts | S ₃ —S.p.s.t. test switch |
| T ₁ —Driver trans. from 375E | SO ₁ , SO ₂ —Twistlock receptacles |
| T ₂ —Mod. trans. from 375E | |
| T ₃ —10-volt 6.5-amp. fil. trans. | |

Provision has been made in the input circuit of the speech amplifier for both a single-button microphone and a crystal-microphone input, with a switch S to select either input circuit. The clipping level control, R₁₁, must be substantially full

open for maximum undistorted output from the 211 tubes in the output stage.

Measurements of the complete modulator, with a 1250-volt power supply feeding plate voltage to the 211 tubes, showed that it was possible to obtain 120 watts of audio output from the tubes with no distortion discernible to the ear or noticeable on the oscilloscope. An output of 145 watts was obtained with an amount of distortion which would be quite tolerable for amateur communications work. No heating of the output transformer was noticed with 120 watts output from the stage into a 7000-ohm load resistor over a test period of about one hour.

The 7000-ohm load impedance could be represented by a Class C modulated r-f amplifier operating from the same plate supply as the 211's (1250 volts) at a plate current of 180 ma. This represents an input of 225 watts to the Class C stage, an amount which may be modulated without difficulty by the modulator unit.

AN/ART-13 AUTOTUNE AIRCRAFT RADIO TRANSMITTER

The AN/ART-13 Autotune aircraft radio transmitter makes a very satisfactory amateur transmitter for phone and c-w operation on the 80, 40, 20 and 10 meter bands. Under normal conditions the transmitter operates very stably and puts out a cleanly modulated or smoothly keyed signal when it is running about 200 watts input. The Autotune feature is a great operating convenience whether the transmitter is to be remotely controlled or controlled from the operating position. With the circuit modifications described herein the Autotune system allows operation on 10 preset frequencies throughout the 80, 40 and 20 meter bands and one additional frequency in the 10 or 11 meter band. Operation with phone or c.w. on any one of these frequencies is obtained simply by moving the panel selector switch to the desired position and waiting approximately 25 seconds for the Autotune system to operate. If desired, several frequencies separated by not more than about 50 kc. may be set up in the 28-Mc. band with an increasing reduction in the frequencies available for lower frequency operation.

Power Supply The major change required to adapt the ART-13 for amateur use is that of providing for operation of the equipment from the 115 volt a-c line. All other changes described are in the nature of operating conveniences

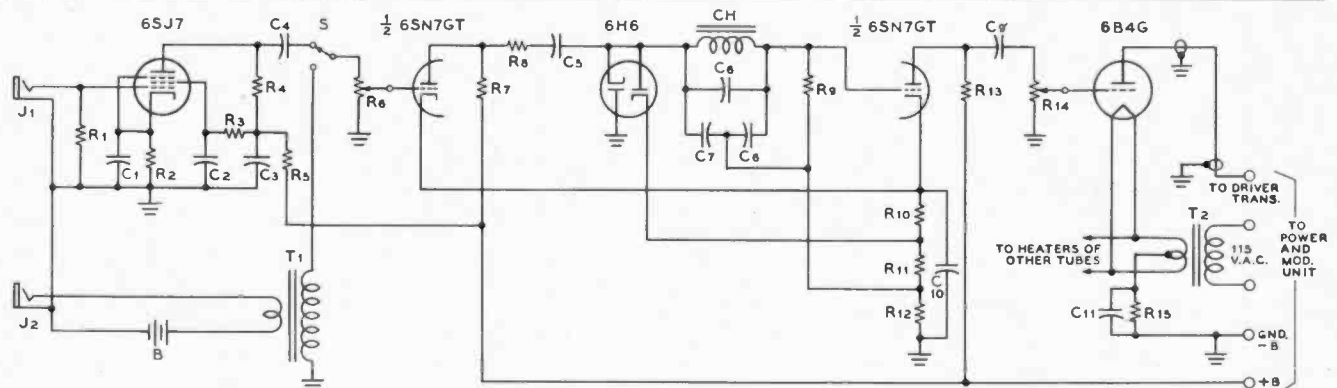

Figure 10.
SCHEMATIC OF CLIPPER-FILTER SPEECH AMPLIFIER FOR THE BC-375E MODULATOR

- | | | | |
|--|--|--|--|
| C ₁ —25- μ fd. 25-volt elect. | C ₁₁ —25- μ fd. 25-volt elect. | R ₇ —500,000-ohm potentiometer | R ₁₁ —250,000-ohm potentiometer |
| C ₂ —0.1- μ fd. 400-volt tubular | C ₁₂ —10- μ fd. 100-volt elect. | R ₈ —100,000 ohms 1 watt | R ₁₂ —750 ohms 10 watts |
| C ₃ —8- μ fd. 450-volt elect. | R ₁ —1.0 megohm 1/2 watt | R ₉ —100,000 ohms 1/2 watt | T ₁ —Mike-to-grid transformer |
| C ₄ —0.01- μ fd. 400-volt tubular | R ₂ —1300 ohms 1/2 watt | R ₁₀ —100,000 ohms 1 watt | T ₂ —6.3 volts at 3 amperes |
| C ₅ —0.1- μ fd. 400-volt tubular | R ₃ —1.5 megohms 1/2 watt | R ₁₁ —330 ohms 1/2 watt | CH—3.5 to 3.75 henry choke |
| C ₆ —175- μ fd. mica | R ₄ —220,000 ohms 1/2 watt | R ₁₂ , R ₁₃ —620 ohms 1/2 watt | J ₁ —Crystal-mike jack |
| C ₇ , C ₈ —200- μ fd. mica | R ₅ —47,000 ohms 1/2 watt | R ₁₄ —47,000 ohms 1 watt | J ₂ —Carbon-mike jack |
| C ₉ —0.01- μ fd. 400-volt tubular | | | |

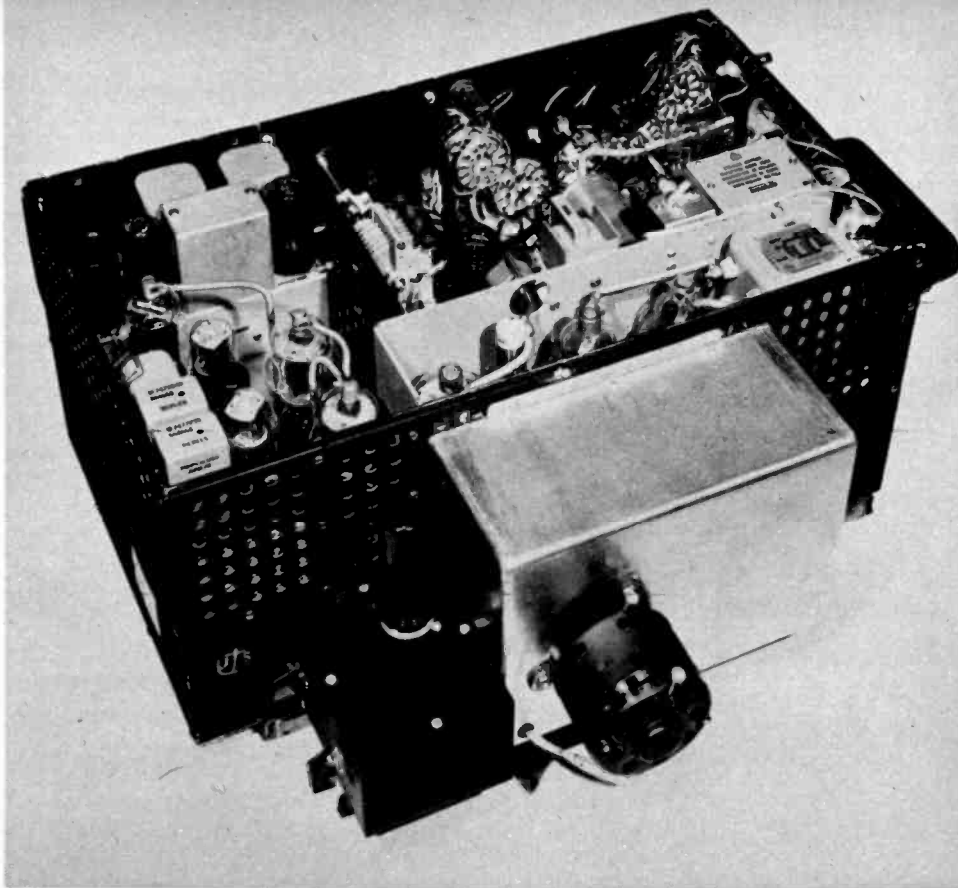

Figure 11.
TOP OF THE CONVERTED
AN/ART-13.

The box containing the blower and the filament transformers for the 813 and the 811's can be seen on the rear alongside the small box which holds the 6L6 multiplier for the 28-Mc. band. The 28-Mc. tank for the 813 can be seen inside the cabinet.

or are for the purpose of obtaining operation in the 28 Mc. region.

The simplest way of converting the equipment is to provide a source of 26 volts d.c. at about 9 amperes for operation of the tube filaments and heaters and for the relays and Autotune motor. Conventional a-c operated power supplies are then used for plate and grid bias voltages. However, due to the difficulty in obtaining components for a high current 26-volt d-c supply, it was deemed desirable in the conversion portion to use a 4-ampere 26-volt d-c supply for the heater tubes relays and Autotune motor, and to supply the filaments of the 813 and the 811 from filament transformers.

The power supply unit shown in Figure 12 has been designed and constructed especially for operation with the AN/ART-13 transmitter. In addition to a complete set of control circuits the unit supplies the following potentials to the ART-13 through the power cable: 1250 volts at a maximum of 300 ma., 400 volts at 225 ma., 26 volts at 4 amperes, 350 volts of negative bias for keying the 813, and 115 volts a.c. for the blower and for the filament transformers for the 811's and the 813. The power supply is housed in a standard cabinet which takes a 12¼ by 19 inch front panel. Careful component placement is necessary to house the power supply unit in a cabinet of this size.

Several of the components used in the 26-volt d-c supply are surplus items since standard manufactured items are not available. In certain cases it will be necessary to have either the transformer or the filter choke for the 26-volt d-c supply made up especially for the job. If a 10-ampere 26-volt output selenium rectifier is obtainable it will probably be best to have a 10-ampere power transformer and choke wound also so that no changes will be required in the filament circuits of the transmitter. The high voltage power supply and control circuits can be the same whether the filaments are all lighted from d.c. or some of them are lighted from d.c. and some from a.c.

Initial operation of the equipment at full input for a period of time showed that considerable heating takes place in the region behind the plate tank circuit for the 813. It was there-

fore deemed desirable to install a cooling exhaust blower on the back of the equipment. The particular blower used is a surplus item but similar a-c operated blowers running at approximately 1500 r.p.m. are available from the larger hardware stores. With this blower in operation the unit runs quite cool and overheating of components is completely eliminated even with long periods of operation. In the particular unit shown in Figure 11 the blower has been mounted in a box on the rear of the housing for the transmitter with the filament transformers for the 811's and the 813 also included within this box.

Control Circuit A time-delay relay which operates from the 26-volt d-c supply has been included in the equipment to insure that all tubes have reached normal operating temperature before plate voltage is applied. If a 26-volt time delay relay is not available, a 115-volt a-c relay of the same type may be used. Protective interlocks have been provided in the power supply unit and in the actual cabinet for the ART-13 transmitter. These two interlocks are connected in series and in turn the two of them are connected in series with the lead to the plate power relay RY, so that plate voltage cannot be applied to the transmitter if the cover has been removed from the ART-13 or if the top door to the power supply box has been opened.

Provision has been made in the control circuit for the transmitter so that when S₁₀₀ on the front of the ART-13 or its counterpart at the remote control position is moved from the off to either the voice or the c-w position, the transmitter will be turned on. Since this switch closes a circuit to ground, it was necessary to find an isolated source of potential to operate the main control relay. This source of potential was obtained by leaving the small transformer T, connected across the line at all times that the unit is plugged into the socket. However, when the transmitter is switched off there is no power drain from any of the secondaries of this transformer.

The push-to-transmit circuit which has been included in the power supply unit is very pleasing to operate and relatively simple in design. It consists of a single 6C5 tube operating from the bias supply along with its associated compo-

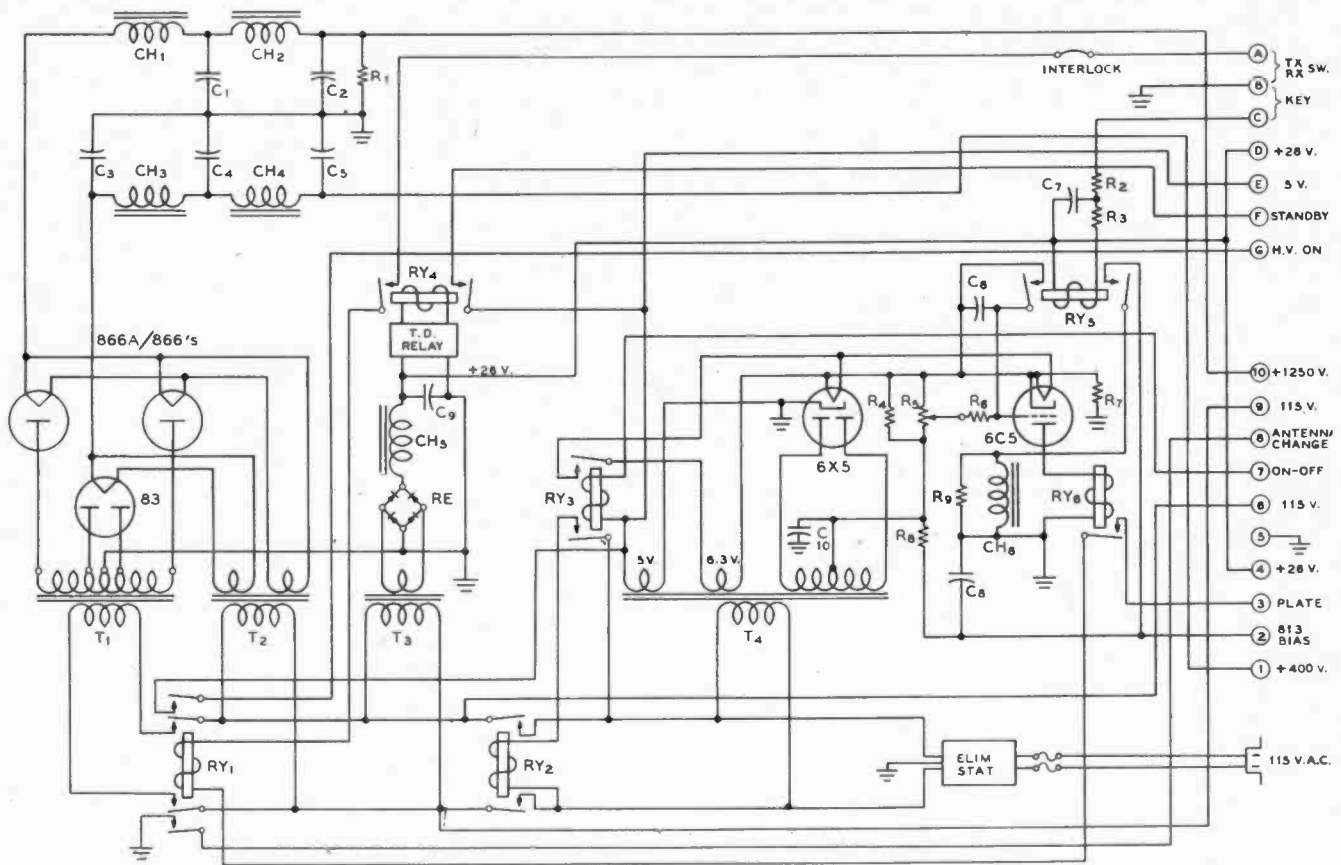

Figure 12.

SCHEMATIC DIAGRAM OF THE POWER SUPPLY FOR THE AN/ART-13.

C₁, C₂—4- μ fd. 1500-volt capacitors
 C₃, C₄—4- μ fd. 600-volt capacitors
 C₅—10- μ fd. 600-volt capacitor
 C₆—0.5- μ fd. 600-volt tubular
 C₇—0.1- μ fd. 400-volt tubular
 C₈—0.05- μ fd. 400-volt tubular
 C₉—4000- μ fd. 50-volt elect.
 C₁₀—8- μ fd. 450-volt elect.
 R₁—50,000-ohm 100-watt bleeder
 R₂, R₃—22 ohms 2 watts

R₄—10,000 ohms 10 watts
 R₅—100,000-ohm potentiometer
 R₆—2.7 megohms 1/2 watt
 R₇—15,000 ohms 10 watts
 R₈—50,000 ohms 20 watts
 R₉—15,000 ohms 2 watts
 T₁—1500 v. each side at 300 ma., 400 v. each side at 175 ma., common c.t. (UTC PA-303)
 T₂—5 v. 3 a., 2.5 volts 10 a.
 T₃—35 volts at 5 a. (special)
 T₄—700 v. c.t. 70 ma., 5 v. 2 a.,

6.3 v. 2 a. (UTC R-2)

CH₁—250-ma. swinging choke
 CH₂—250-ma. filter choke
 CH₃, CH₄—200-ma. filter chokes
 CH₅—0.05 henrys at 4 amp. (special)
 CH₆—13-henry 65-ma. filter choke
 RY₁—28-volt d-c 4-pole d.t. relay
 RY₂—115-volt a-c 2-pole relay
 RY₃—6.3-volt or 5-volt 2-pole relay (RY₂ and RY₃ may be

combined if contacts of RY₃ can carry about 8 amperes and if 3 contacts are available.)

RY₄—28-volt d-c time-delay relay (115-volt a-c time-delay relay may be used across primary of T₃ if 28-volt relay not avail.)
 RY₅—28-volt d.p.d.t. keying relay
 RY₆—2500-ohm sensitive relay
 Elimstat—A-c line filter

nents. The complete circuit is shown in Figure 12. When the key is up relay RY₃ is open and the voltage drop across R₆ to the slider is impressed on the grid of the 6C5 tube, cutting off its plate current. When the key is pressed RY₃ closes and the right-hand side removes the blocking grid bias from the 813 by shorting the grid return to ground through R₈ and CH₆. These latter two components in conjunction with C₈ make up a very effective key-click filter. The effectiveness of the circuit is illustrated by the fact that clicks cannot be heard from the transmitter on a communication receiver tuned to the same band for break-in c-w operation.

At the same time that RY₃ is closing, the other set of contacts on this relay shorts the grid of the 6C5 to its cathode, causing full plate current to flow through RY₄ and R₇, thus closing RY₄. When RY₄ closes the antenna changeover relay in the ART-13 operates and plate voltage is applied to the transmitter by RY₁. Then when the key is lifted RY₃ opens so that plate current to the 813 is stopped, but due to the time constant of the R₆-C₈ combination, plate current still flows through RY₄. Hence the plate voltage remains on the transmitter and the antenna relay is still in the transmit position.

The transmitter remains in this condition until the voltage across C₈ has built up to such a value that RY₄ drops out, changing everything back to the receive condition. The amount of this delay is variable, by adjustment of potentiometer R₅ from a fraction of a second up to about 15 seconds. The normal setting is for about 3 seconds so that the plate voltage will remain on for the normal short pauses in a c-w transmission but will drop back to the receive condition 3 seconds after a transmission has been completed.

Changes in ART-13 Control Circuits

It is necessary to make a certain number of modifications in the various circuits of the ART-13 in order to allow the equipment to operate from the power supply unit described before and illustrated in Figure 12. It is necessary first that the meter switch circuit be changed in the following manner: Remove ground from bottom end of R₁₁₁ (235-ohm resistor) and connect this end of the resistor to terminal A₂ of S₁₀₅. Remove the wire that now goes to terminal B₂ of S₁₀₅ and connect this wire to terminal A₂ of S₁₀₅ along with the bottom end of R₁₁₁ above. This series of changes brings the

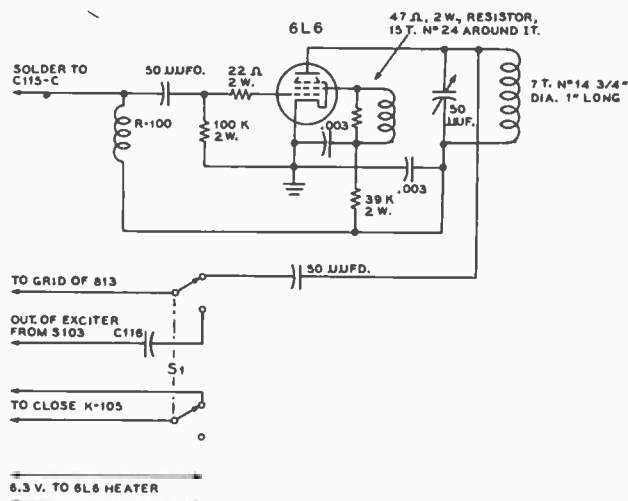

Figure 13.

SCHEMATIC OF THE 28-MC. MULTIPLIER STAGE.

grid return of the 813 tube out to terminal 2 on the main power connector J_{106} .

The following changes are required in the power control circuits: Ground the lead inside the cabinet which now goes to terminal 8 on J_{106} . Remove the lead now going to terminal 14 of J_{114} which is mounted on the side of the antenna change-over relay K_{102} . Insulate this lead. Now run a lead from terminal 8 of J_{106} to terminal 14 of J_{114} . A lead is now run from terminal 2 on the loading coil relay connector J_{107} to terminal C in the power supply unit. This is the only lead brought out of the transmitter which does not go through the main power connector J_{106} .

The filaments of the 813 and of the 811's should be re-wired to operate from separate transformers mounted on the rear of the equipment. One side of the filament may be left grounded on the 813 but the center tap of the filament supply to the 811's must be grounded in order to eliminate hum modulation on audio peaks. The primary of the filament transformer and the cooling blower for the equipment should now be connected to terminals 6 and 9 on J_{106} . These terminals are supplied with 115 a.c. from the power supply unit when the equipment is in operation. The driver transformer returns which formerly went to one side of the filament of each 811 are now grounded to the chassis of the transmitter.

Several changes may be made in the vicinity of the high-frequency/low-frequency relay K_{106} whether or not the 10-meter band is to be included in the transmitter. In the first place the low-frequency choke L_{106} may as well be removed from its present position and C_{124} mounted in the space formerly occupied by L_{106} . One additional hole must be drilled in the fire wall of the equipment. It is suggested that a protective interlock now be mounted in the position formerly occupied by C_{124} on the fire wall of the transmitter. The leads to this interlock should be connected in series with the lead now going to terminal 3 of J_{106} . The interlock should of course be mounted in such a manner that it is closed only when the cover is firmly in place on top of the transmitter.

A slight increase in operating convenience can be obtained through replacing the 0-5 r-f ammeter with a 0-300 or a 0-500 d-c milliammeter. The r-f transformer T_{102} may be removed after the leads have been clipped by unscrewing it from the chassis. With the installation of this additional milliammeter it is possible to read grid current and plate current on the 813 simultaneously.

Converting for 28-Mc. Operation The conversion of the ART-13 for 28-Mc. operation may be accomplished in several different ways of varying difficulty. However, in converting the unit shown in the photographs, it was felt that a conversion method which did not involve any disassembly of the Autotune mechanism and which required no changes in the exciter of the transmitter would be best. So it was felt best simply to add a 6L6 outboard tripler stage on the rear of the transmitter in the vicinity of the grid of the 813. The 6L6 tripler is fed energy from the 1625 second multiplier in the ART-13 in the 9.0 to 10.8 Mc. frequency range. The plate circuit of the 6L6 then may be tuned to any frequency between 27 and 32.4 Mc. for feeding excitation to the grid of the 813 amplifier. In fact, if desired, the 6L6 may be used as a doubler from the same frequency range to deliver excitation to the grid of the 813 in the 21-Mc. range.

The 6L6 multiplier is housed in 2" by 4" by 4" standard metal "cabinet" which has been mounted to the side of the cabinet which houses the blower and the filament transformers for the 811's and 813. S_1 in the circuit diagram of the multiplier, Figure 13, may be either a double-pole double-throw ceramic switch or a 28-volt d.p.d.t. relay which may be operated from the 28-volt supply for the transmitter. In the particular unit shown in the photographs a switch is used but it is planned to replace the switch with a relay for completely remote operation of the transmitter. The relay will be operated by another set of contacts on the channel-selector switch which will be closed whenever the 28-Mc. band is chosen. Heater voltage for the 6L6 may be obtained from a small transformer or from the supply for the 811's if they are operated from a.c.

The circuit of the 6L6 multiplier is otherwise quite conventional except for the manner in which plate voltage is obtained for the 6L6 multiplier. Careful inspection of the circuit diagram of the ART-13 will show that the 400 volts applied to the plate of the 1625 multiplier appears across only one section of the padder capacitor C_{116} at a time and only when that particular section of the padder capacitor is in use. Hence, by connecting an r-f choke to padder capacitor which is used to excite the grid of the 6L6 in the 9.0 to 10.8 Mc. range, 400 volts from the exciter power supply may be obtained by filtering the r-f out of the d-c line with an r-f choke and a by-pass capacitor. A 50- μ fd. mica capacitor is then used to excite the grid of the 6L6 multiplier from the hot side of the r-f choke. In this way the 6L6 multiplier is completely out of the circuit except when control A is in position 9.

The lead from coupling capacitor C_{116} to the grid of the 813 is broken and a lead brought out from each side of the point where the connection was broken. These two leads are then connected as shown in Figure 13 to the 6L6 multiplier unit. One set of contacts on S_1 is used in addition to close K_{106} , which switches the plate of the 813 from the network used on the low-frequency bands to the separate 28-Mc. tank which has been placed in the position inside the cabinet of the ART-13 which was designed to hold the low-frequency oscillator unit. In the particular transmitter shown the 28-Mc. tank for the 813 consisted of a 6-turn coil of number 10 enamelled wire $1\frac{1}{4}$ inches in diameter and $1\frac{1}{2}$ inches long. A two-turn link feeding a piece of 300-ohm line is then run over to the left wall of the transmitter where it terminates in a pair of terminals. With this tank the 813 dips to about 30 ma. on 28 Mc.

The two terminals which close K_{106} may be picked up as terminals 7 and 4 on the connector J_{115} which feeds plate and filament supply to the multiplier unit of the ART-13. A pair of leads from these two terminals are run to the 6L6 multiplier unit so that they are closed whenever the 6L6 is in operation. With the 6L6 frequency tripler as shown it is possible to obtain half scale on the grid current meter throughout

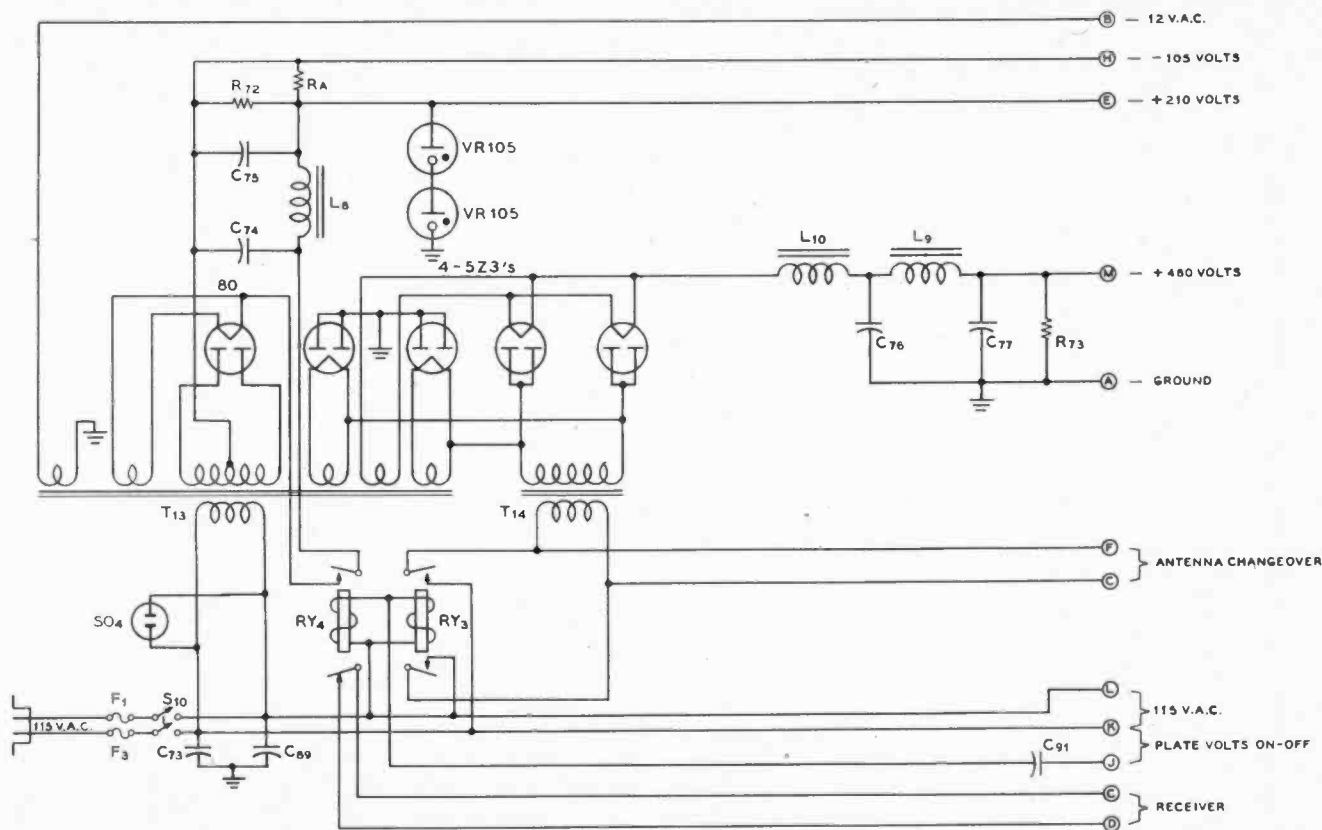

Figure 14.

SCHEMATIC DIAGRAM OF THE MODIFIED PE-110A OR PE-110B.

All the components shown in this diagram are included in the PE-110B power supply except L₁₀, R₇₃, and R_A. The PE-110A power supply is the same except that C₉₁ is not included. L₁₀ is a 200 ma. to 300 ma. swinging choke which is mounted in the position formerly occupied by the 12-volt vibrator pack. Resistor R₇₃ is a 50,000-ohm 20-watt bleeder resistor. Resistor R_A may be replaced by a VR-105 regulator tube for regulated grid bias of 105 volts or a resistor of about 3000 ohms may be used for a drain from the regulated plus 210 volt lead of about 20 ma. If the drain from this voltage is to be greater than about 20 ma. a lower value of resistor should be used for R_A to insure that the two VR-105 tubes in series will light. R_A should run from -105 to ground rather than to +210 as shown.

the 28-Mc. band; this represents about 8 to 9 ma. of grid current on the 813.

Note in Regard to the Output Network of the ART-13

The output network of the AN/ART-13 is designed to operate as an "L" network on frequencies up through about 5 Mc. This is required since the transmitter was designed to feed an antenna installed on an aircraft which would have a very low radiation resistance at these low frequencies but would have a relatively large value of capacitance to ground. This network will *not* feed satisfactorily the types of antennas commonly used by amateurs for fixed-station use in the 3.5 to 4 Mc. band. Hence it is desirable to convert the L network into a pi network when operating on the 80-meter band. The simplest way to do this is merely to place a capacitor of 100 to 400 μmfd. from the "COND" terminal on the left end of the transmitter to the ground terminal on the case. A variable capacitor may be used to determine the best value for this capacitor, and then a fixed air capacitor or a ceramic transmitting capacitor of the type used in the transmitter may be hooked in place. Experiment showed that a value of about 200 μmfd. was best for feeding a folded dipole with 300-ohm twin line on the 3.5-Mc. band.

Tests of the completed transmitter have shown that there is no appreciable increase in output after the plate current on the 813 is increased above 160 ma. This represents a power input of 200 watts at 1250 volts and the plate circuit efficiency runs from 70 to 75 per cent on all bands. The out-of-resonance

plate current will be from 180 to 200 ma. with normal excitation and antenna coupling should be adjusted until 160 ma. of plate current is drawn by the 813 tube.

A description of the modification of the speech amplifier for the ART-13 for use with a crystal microphone is given later in this chapter.

PE-110-A AND PE-110-B CONVERSION

These power supplies have been available from several sources, and they are capable of doing a nice job on the exciter stages of a transmitter. The control circuit originally in the supplies can be modified by simply rewiring the 115-volt circuits so that relay control of the 300-volt and high-voltage supply is obtained. The high-voltage supply in the original unit operates with a capacitor-input filter. Hence the no-load voltage is about 800 volts, and it drops down with a load of about 250 ma. to approximately 500 volts. By adding an input choke in the position formerly occupied by the 12-volt vibrator pack, the voltage regulation of the supply can be greatly improved. With a swinging choke in this position as shown in Figure 14 the no-load voltage is about 480 volts, and under a load of 300 ma. the output voltage drops to about 430 volts. Either a Stancor C-1720 choke or a UTC PA-103 choke may be placed in the position made available by the removal of the vibrapack. The no-load voltage output of the low-voltage power supply is about 350 volts, and at a load of 60 ma. this voltage drops to about 275 volts.

This power supply unit makes an ideal arrangement for

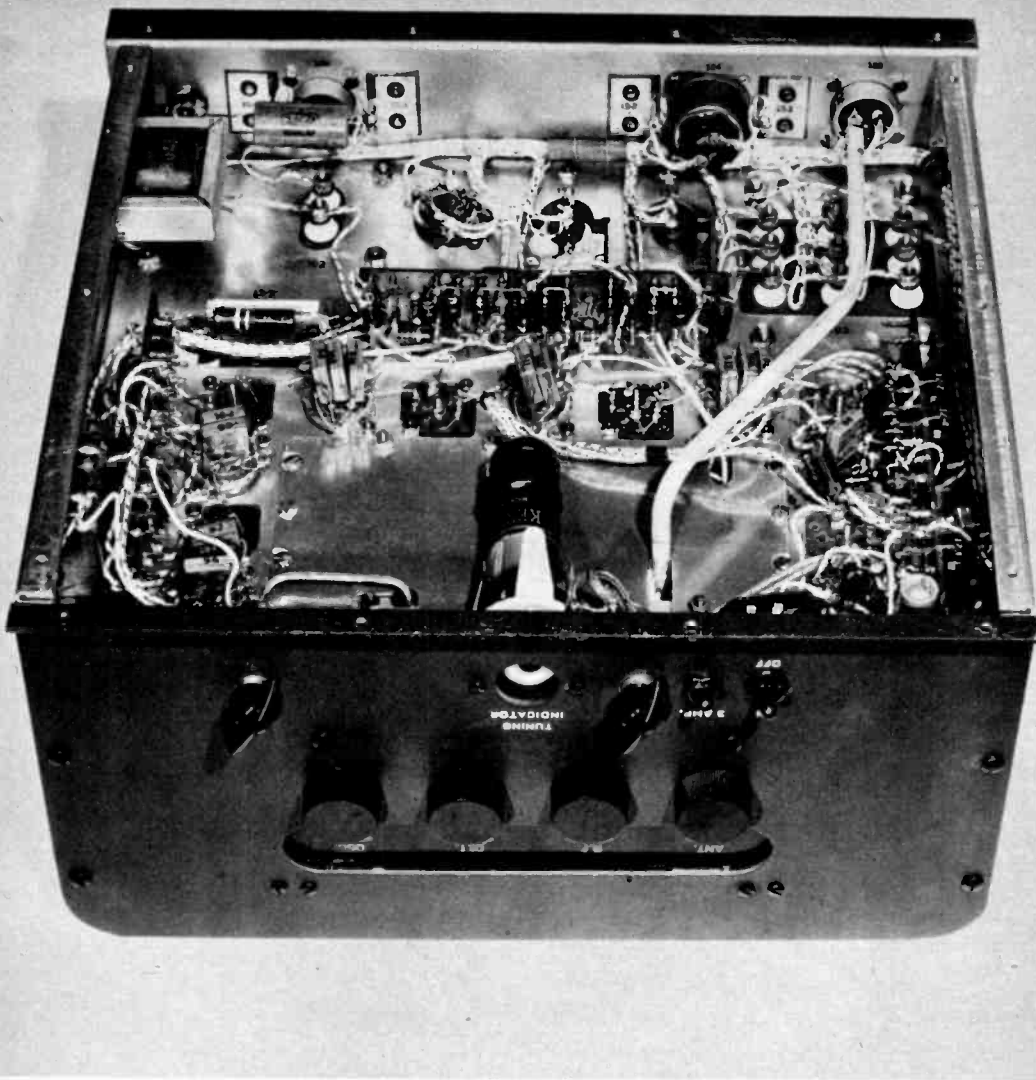

Figure 15.
BC-1068A RECEIVER WITH
THE RECOMMENDED
CHANGES MADE.

Most of the audio changes are made on the terminal strip and the two tube sockets on the left of the chassis just behind the front panel. The newly installed controls can be seen on the front panel.

supplying the v-f-o from the 250-volt supply and operating the multiplier stages and a pair of 807's in the final amplifier of the exciter or transmitter from the 450-volt supply.

The input connector, PL-5 on the front panel can best be removed and replaced by an Amphenol 61-M-10 a-c flush plug. If desired, the other connector, PL-6, may be replaced by an inexpensive Jones plug and receptacle of the 300 series, such as was shown on the rear of the BC-312 described earlier in this chapter. Or, if desired, an AN3106-28-8P plug can be obtained from Cannon in Los Angeles or Amphenol in Chicago. The price, with AN 3057-16 cable clamp, is about \$4.00 for the assembly.

The circuit has been modified, as shown in Figure 14, in such a manner that both sides of the line are switched by S_{10} . Two of the fuses are placed between the input receptacle and the line switch. SO_1 is connected so that it is energized only when the main line switch is closed; hence the 115-volt supply for other units in the transmitter may be taken from this outlet, with S_{10} acting as the main control switch for the transmitter. A winding on T_{10} supplies 13.1 volts at 5 amperes to an external load. This voltage may be used to operate the 12-volt counterparts of the common tubes (1625 for 807, 837 for 802, 12A6 for 6V6, etc.) or the 6-volt tubes may be connected in series parallel in such a manner that they may be operated from the 12.5 to 13.1 volt winding on the transformer.

The plate transformer for the 5Z3's is rated at 0.455 ampere r.m.s. This means that with a capacitor-input filter as originally used, the power supply is capable of 250 to 300 ma. But with a choke-input filter having chokes of adequate current capacity the plate transformer, at least, is capable of about 400 ma. d-c load.

A photograph of the PE-110B power supply is shown in conjunction with the 807 transmitter using BC-610E tuning drawers as described in Chapter 26.

BC-1068-A CONVERSION

Conversion of the BC-1068-A IFF receiver for operation as an AM receiver on the 2-meter band is a relatively simple process requiring only a few hours time. When the conversion has been completed the owner will possess a quite satisfactory and very conservatively designed receiver which will cover the frequency range from about 140 Mc. to approximately 175 Mc.

Installation of New Controls The first process in the conversion is to remove the power switch, both fuses, the tuning indicator, and the interlock-type switch on the right front of the panel. All leads should be removed from the interlock switch, and from both fuses. The lead from the right-hand pilot lamp should then be run to the outside end of heater choke 100-1 on the top of the right-hand resistor board. The lead for the other pilot lamp can then be connected to pin 7 on the socket which was used for the 6SH7 video amplifier.

One of the red-tracer wires which went to the interlock switch is carefully pulled out of the cable. One end of the other red-tracer wire is then soldered to one side of a s.p.s.t. toggle switch which has been placed in the position formerly occupied by the 3-amp. fuse. The other end of this red-tracer wire is pulled back through the cable far enough so that, with a lug placed on its end, it may be bolted to terminal 4 on the power transformer. The lead which formerly went to terminal

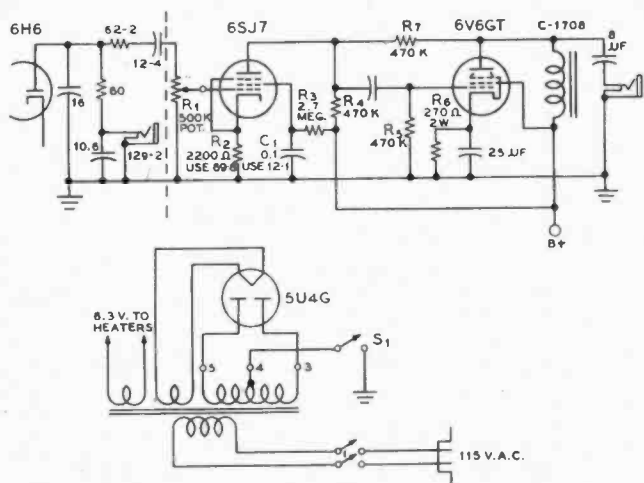

Figure 16.

MODIFICATIONS TO BE MADE IN THE BC-1068A.
 The original components of the receiver which are used in the modification described in the text are shown with their original designation numbers.

4 on this transformer is bolted beneath terminal 9 on the power transformer along with the lead which already went to terminal 9. The other side of the communication switch, S₁ in Figure 16, is then grounded to the lug which is adjacent to it. A lead is then run from the end terminal of the left hand resistor board to the B plus lead on this board at the bottom of resistor 72-2. This procedure applies plate voltage to the tuning indicator all the time that the receiver is operating.

The hole which formerly took the interlock switch is reamed out slightly and a 5000-ohm wirewound i-f gain control is placed in this hole. The center terminal of the gain control is grounded to capacitor 14 and the right outside terminal is connected to the top of resistor 56-3 on the right end of the resistor board in the center of the chassis.

The odd 115-volt receptacle on the rear of the chassis is removed and an Amphenol 61-M-10 receptacle of the standard male 115-volt variety is substituted. The old mounting holes fit perfectly. The power switch 127 is then wired back into the circuit without the fuse in series.

Audio Circuit The video output circuit is then removed and the audio circuit shown in Figure 16 is substituted. It will be found best to remove completely the tube socket for the output tube and clean up the terminals since all the connections must be changed when the 6V6-GT is substituted for the 6SN7-GT. The resistors should be removed also from the first six positions on the terminal board to make space for the new values required for the audio circuit. Shielded leads should be run from the detector output to the volume control (which has been mounted in the place of the SPARE fuse) and back to the grid of the 6SJ7 first audio. Either a choke and capacitor or an output transformer may be used in the plate circuit of the 6V6-GT output tube. In either case the output circuit may be mounted on the extreme rear of the chassis near the filter choke and the lead which already runs from the audio section to spark-plate 15-3 used for the connection to the plate of the 6V6-GT. This audio system will be found to give ample gain and good audio quality on a received signal.

I-F Realignment With the receiver operating into a loud-speaker but with no signal being received by the front end the i-f and audio controls are turned up until a moderate amount of noise is being received. Then i-f transformers 3 and 5 are peaked up for maximum noise, and for maximum deflection on the tuning indicator. Transformer 4 is then also peaked up. A very marked increase in noise level should be obtained. The i-f will now be found to be peaked at about 11.5 Mc.

R-F Realignment The oscillator circuit is not changed since it covers a range which is ample for the 2-meter band by operating it on the high side of the incoming signal instead of on the low side as was done in the original application. The ANT, R.F., and DET coils are carefully squeezed together as far as they will go with the aid of a pair of long-nosed pliers. Be careful that the turns do not touch and that the silver plating on the wire of the coils is not damaged. With the oscillator set from about 3.0 to 4.2 the 2-meter band should be covered with the r-f, det., and ant. circuits tuning from about 1.0 to 2.5 on their dials. Some improvement in gain and signal-to-noise ratio may be obtained by replacing the 6SH7 first r-f stage with a 6AK5 by making

Figure 17.
UNDERCHASSIS OF THE MODIFIED 26S-1 SPEECH AMPLIFIER.

Note how the switch for changing the output impedance of the side-tone amplifier has been rotated through 90°.

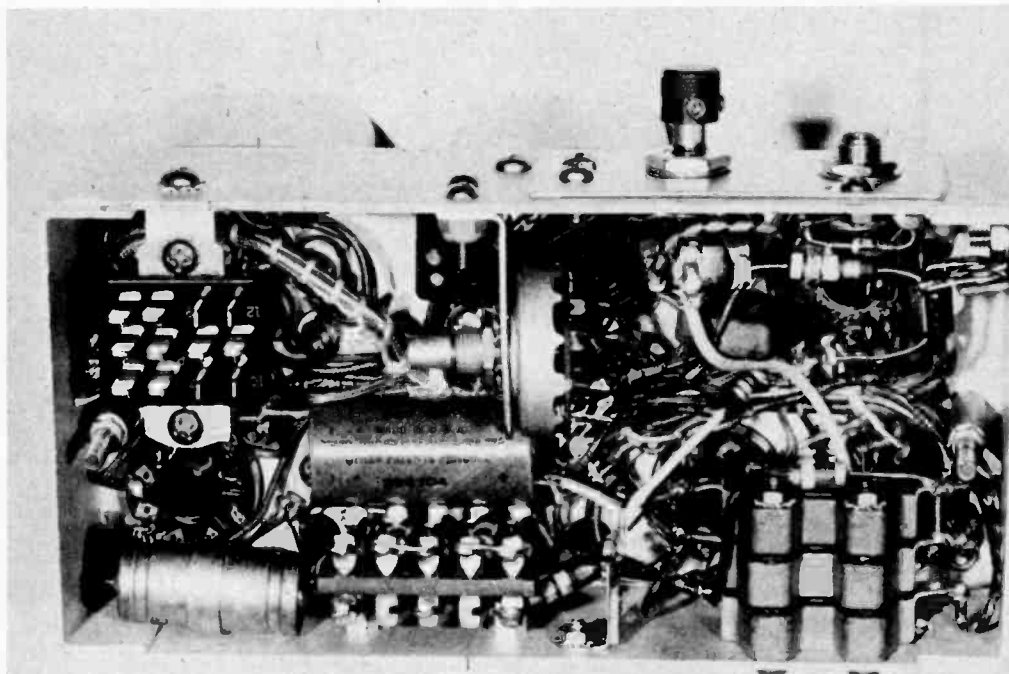

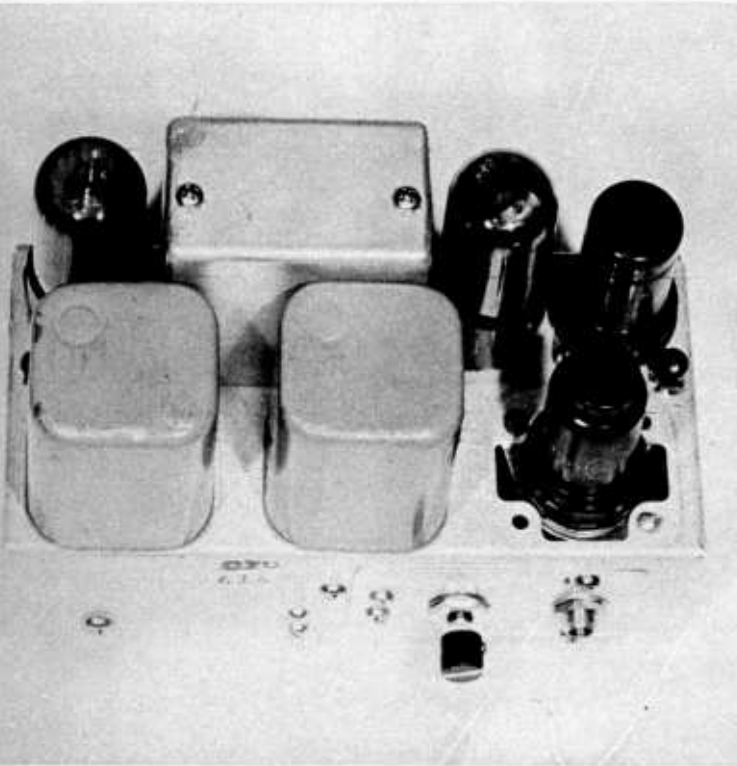

Figure 18.

TOP PHOTO OF THE MODIFIED AMPLIFIER.

Note the mounting of the socket for the 6C5 first speech stage. The small panel which has been added over the chassis opening as mounting for the gain control and the jack for the crystal microphone can be seen.

an adapter from the octal socket in the receiver to a miniature socket for the 6AK5. The shortest possible leads should be used and a 200-ohm resistor with a 50- μ fd. ceramic by-pass capacitor should be placed in series with the cathode lead of the 6AK5.

There is ample room on the chassis for the addition of a 10.7-Mc. discriminator transformer on the chassis with its associated 6AL5 diode if FM reception in the 140 to 175 Mc. range is desired. However, it is not recommended that an i-f sharper than the realigned 11-Mc. channel be attempted unless the stability of the oscillator stage is improved and the small amount of backlash is taken out of the drive for the oscillator tuning slug. The backlash and moderate instability give no trouble with a broad i.f. but will give trouble with a sharp i.f.

COLLINS 26S-1 SPEECH-AMPLIFIER UNIT, ADDING CRYSTAL MICROPHONE INPUT CIRCUIT

The 26S-1 speech amplifier-driver unit is used to operate from a carbon microphone or a high-level dynamic microphone to drive a pair of 811 Class B modulators in the AN/ART-13 Autotune transmitter. The little amplifier has been widely available on the surplus market and is ideally suited to use as a speech amplifier and driver for a pair of 811's or HY-5514's as a Class B modulator, in addition to its normal application in the ART-13 transmitter.

The speech amplifier utilizes a 12SJ7 first stage coupled to a 6V6-GT amplifier-driver with feedback from the plate of the 6V6-GT back to the plate of the 12SJ7. Approximately one-half volt peak is required at the grid of the 12SJ7 to obtain full output from the 6V6-GT stage. Since the conventional crystal microphone delivers from 0.05 to 0.1 volt with normal talking it is necessary to add an additional stage ahead of the

12SJ7 in order to obtain adequate gain with a crystal microphone input. A 6J5 or 12J5 in the first stage, with a voltage gain of approximately 14 under normal operating conditions, gives ample additional amplification so that the gain control may be turned down for full modulation of the transmitter with normal talking about one foot from the microphone.

The input transformer T-201 along with its associated components must be removed from the amplifier to make room for the added stage of amplification. This means that operation from a carbon microphone or a low-impedance dynamic microphone must be sacrificed. But a high-impedance dynamic microphone may still be used instead of a crystal microphone as the input to the amplifier.

Specifically, the following components must be removed from the amplifier: R201, R202, R203, R204 (and the terminal board holding these four resistors), R-205, R-206, R-216, T-201, and S-201. The sidetone output switch S-202 is swung back and out of the way. Then an octal tube socket (an Amphenol 78-RS-8 socket fits the mounting holes, but the chassis must be filed slightly to admit the socket proper) is fitted into the space vacated by the removal of T-201. The socket is then removed from the unit and as much of the wiring as is possible (schematic shown in Figure 19) is soldered to the socket while it is outside the chassis.

Whether a 6J5 or a 12J5 is to be used, pins 1 and 2 should be grounded to a lug which will be held by the socket mounting bolt. If a 6J5 is to be used a 22-ohm 2-watt resistor is run from pin 7 on the 6J5 socket to pin 7 on the adjacent 6V6-GT.

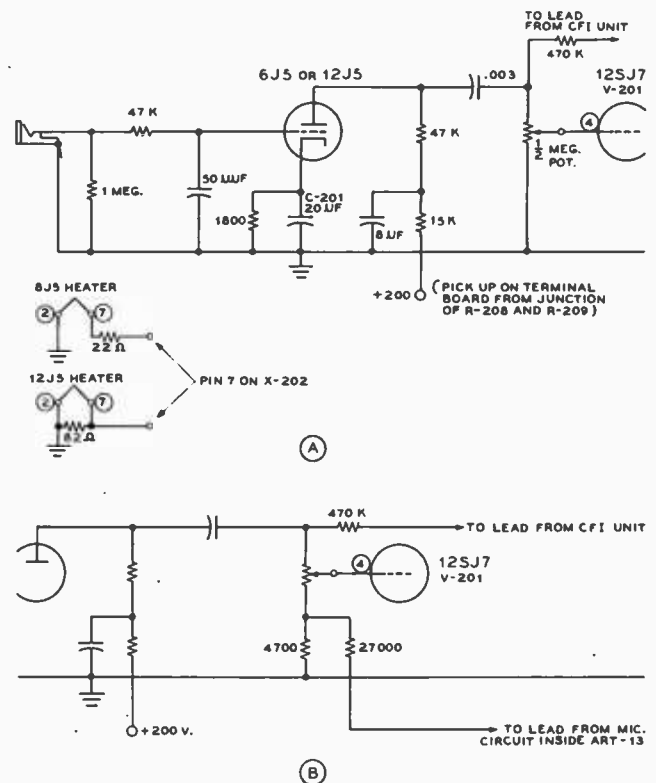

Figure 19.

SCHEMATIC OF THE INPUT CIRCUIT ADDED FOR CRYSTAL MIKE USE.

Capacitor C-201 is already in the equipment, having been used in the filter circuit for the carbon-mike current. The simple additional modification shown at (B) can be made in the circuit shown at (A) if it is desired to feed the transmitter with modulating signal through the remote-control cable. If this provision is made the remote modulating signal is fed in between the "mike" lead and ground.

Figure 20.
PHOTOGRAPH OF THE SIM-
PLE LM POWER SUPPLY.

An LM frequency meter is shown
alongside the power supply for
comparison.

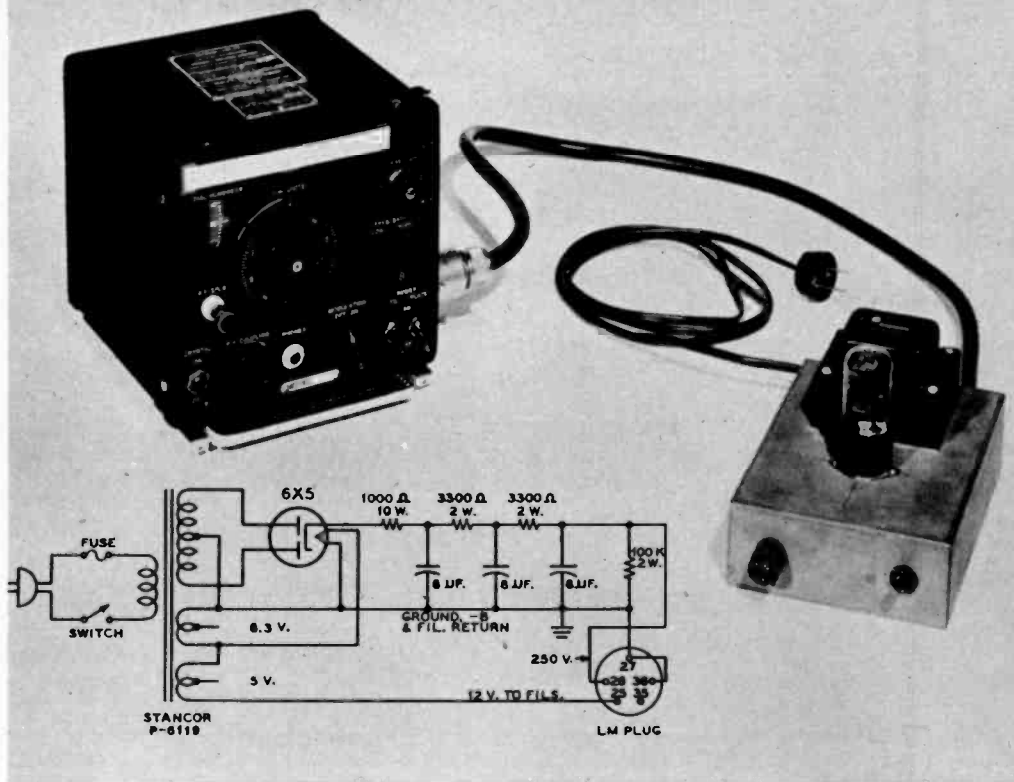
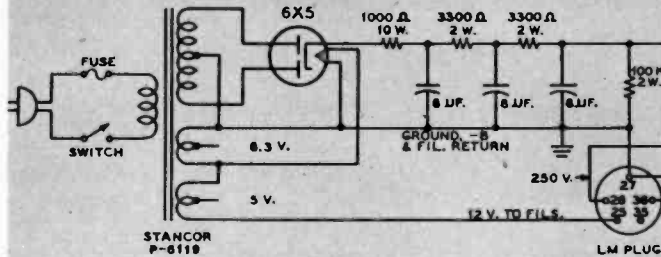

Figure 21.
SCHEMATIC OF THE SIM-
PLE LM POWER SUPPLY.

The 5-volt and 6.3-volt windings on
the transformer are connected in
series to obtain filament voltage
for the LM. Due to the light load
on the filament windings the fila-
ment voltage measures about 11.9
volts on the filament lead. This
value of voltage is well within the
filament voltage tolerance of the
heater tubes used in the frequency
meter.



If a 12J5 is to be used an 82-ohm 2-watt resistor should be connected between pins 2 and 7 on the 12J5 socket and a lead from pin 7 run to pin 7 on the adjacent 6V6-GT socket. The current drain from the line is the same with either tube type.

An aluminum plate should be made to cover the hole in the front of the chassis and the microphone jack and gain control mounted on this plate. If the amplifier is to be used inside an ART-13 make sure that the mounting holes for the gain control and socket line up with the holes in the front of the ART-13 cabinet. When using the modified amplifier in conjunction with an ART-13 the signal from the crystal calibrator is fed in to the top of the 500,000-ohm potentiometer by means of a 470K resistor. If it is desired to retain the ability to operate the equipment from a remote point, the audio signal from the remote control cable (and from the microphone jack on the front of the ART-13) may be fed into the amplifier through the use of an arrangement such as is shown in Figure 19B. With the values of resistors shown approximately 3 volts peak will be required on the audio input line (approximately zero level referred to 6 milliwatts in a 500-ohm line).

SIMPLE A-C POWER SUPPLY FOR THE LM FREQUENCY METER

Figures 20 and 21 illustrate a very simple power supply for operation of one of the LM series frequency meters from the 115-volt a-c line. Plate voltage for the frequency meter is obtained from a small power transformer with a 6X5-GT rectifier. Due to the very low plate current requirements of the frequency meter a resistance-capacitance filter has been used on the plate voltage supply. With the transformer shown and the values of resistance and capacitance listed the plate voltage supplied to the frequency meter is 255 volts. This voltage is sufficient to cause the neon regulator tubes to strike with certainty when the voltage-change strap in the LM is adjusted to the 200-260-volt position.

By connecting the two filament windings on the power transformer in series it is possible to obtain adequate heater voltage for the frequency meter. Due to the light load on these two filament windings the voltage applied to the LM under normal operating conditions is 11.9 volts; this value of voltage is well within the plus or minus 10 per cent heater

voltage limit on the tubes used in the equipment. Through the use of a 6X5-GT rectifier, which has the heater well insulated from the cathode, the rectifier may be lighted from the same filament windings which light the tubes in the frequency meter. No changes whatever are required inside the LM frequency meter when it is used with the power supply shown in these illustrations.

V-F-O USING BC-221 FREQUENCY METER

Either a Navy Model LM or Army BC-221 frequency meter may be used as the frequency controlling element in a variable-frequency oscillator for amateur-band use. Both these frequency meters have a low-frequency range, which is unused, and a high-frequency range from 2 to 4 Mc. which may be used as a v-f-o frequency control. Since the voltage output of the frequency meter is quite small it is necessary to amplify this output voltage many times before sufficient voltage will be available to excite the first stage in the transmitter. The most satisfactory system for accomplishing this amplification is to use several cascaded untuned Class A stages ending up in a power stage with a tuned plate tank circuit.

The v-f-o unit illustrated by Figures 22 through 25 uses two cascaded 6AG7 stages with untuned load circuits to excite the grid of a 6L6 power amplifier stage which operates into a tuned plate tank circuit on the 3.5-Mc. band. Although a knob has been brought out to the front panel for tuning the output circuit of the 6L6 it has been found by operation of the exciter that once the tank has been tuned to resonance in the center of the 3.5-Mc. band the output will remain constant over the band without any adjustment. Hence this tuning control may be replaced by an air padder capacitor adjustable from the rear of the unit.

Mechanical Details The frequency meter was removed from its cabinet and mounted in a Bud 999 cabinet.

Then the assembly was flush mounted in the center of a 12¼ by 19 inch dural rack panel, as can be seen by reference to Figure 22. The balance of the components for the exciter are then mounted on an 11 by 17 by 3 inch chassis supported from the front panel by means of support brackets.

The underchassis view, Figure 24, shows the manner in



Figure 22.
FRONT PANEL VIEW OF THE BC-221 V.F.O.

The controls on the front panel, reading from left to right, are: (1) function switch, the output of the frequency meter is brought out directly to a coaxial connector in the rear on the left position, in the center position the output of the meter goes to the input of the v-f-o amplifier for transmitter control, and in the right position the v-f-o is turned on for spotting in the receiver; (2) main a-c line switch; (3) alternate v-f-o plate supply switch; (4) filament switch for v-f-o portion; (5) 60-ma. r-f indicator light; (6) tank capacitor for 6L6 output circuit.

which the subchassis has been divided into three compartments by a pair of shield partitions. The voltage regulated power supply components and filament transformers are mounted in the rear section, the r-f circuits are mounted in the center section, and the filter components for the power supply are mounted in the front section below the cabinet which houses the BC-221.

Circuit of the Equipment Figure 25 shows the circuit for the r-f amplifier portion of the exciter unit. The voltage-regulated power supply for the exciter is identical to that described in Chapter 25. Regulated voltage from this supply is fed to the BC-221 and to the screens of the two 6AG7 amplifier stages. The plate voltage for the two 6AG7's and the plate and screen voltage for the 6L6 is taken

Figure 23.
SIDE VIEW OF THE FREQ.-METER/V-F-O UNIT.

Note the coaxial line from the frequency-meter output to the main chassis. All the terminations are brought out to the rear of the chassis. The coaxial connector on the left of the rear is for v-f-o output and the coaxial connector on the right is for output directly from the frequency meter.

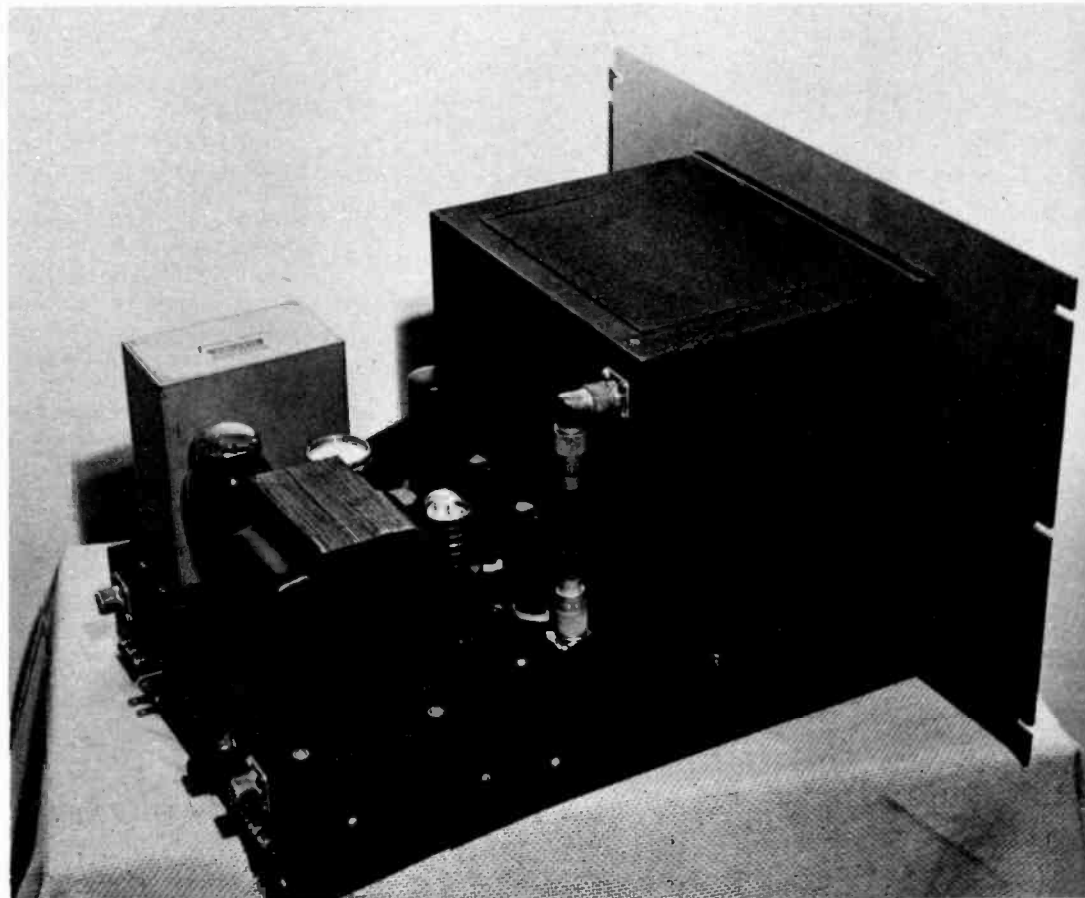
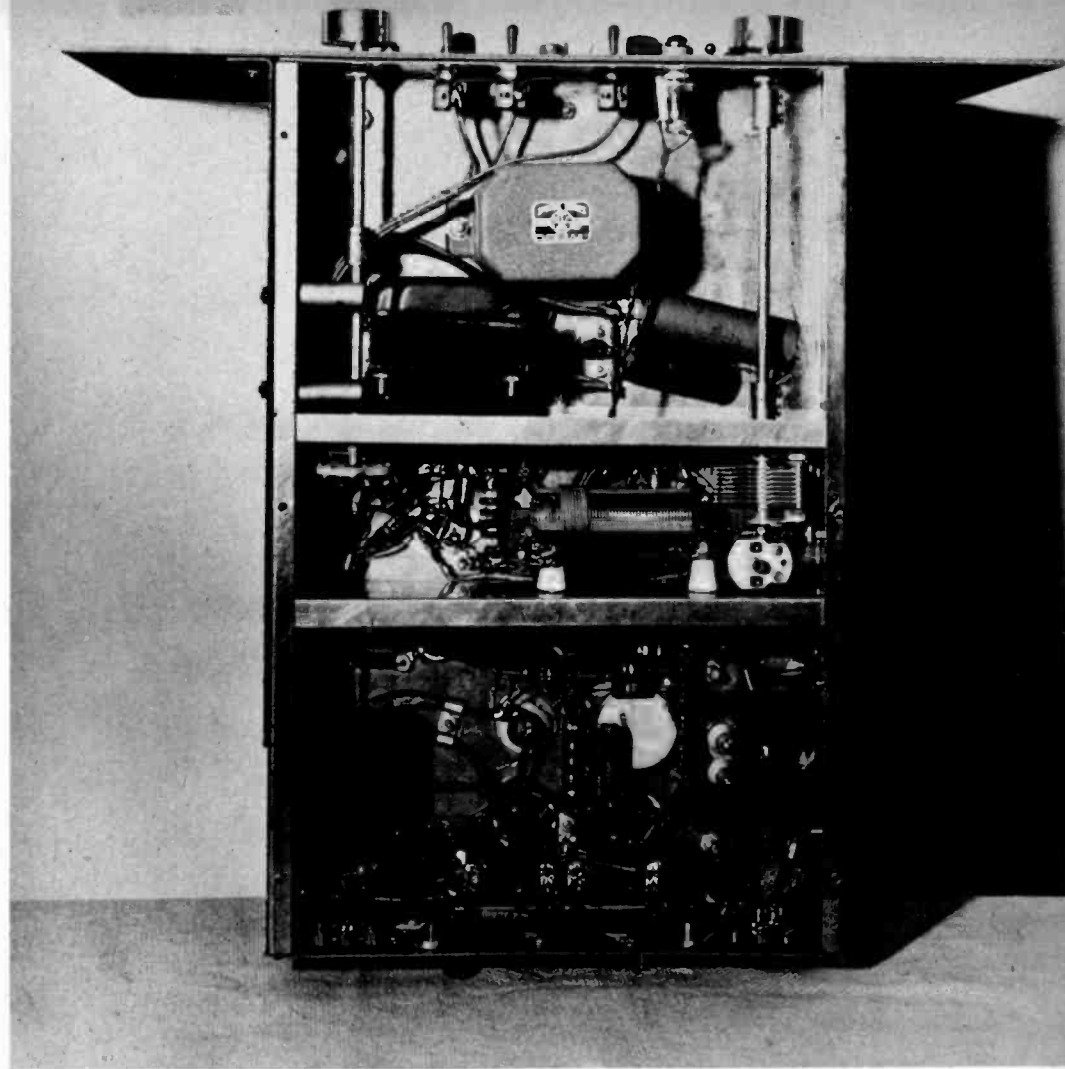

Figure 24.
UNDERCHASSIS OF THE
V-F-O UNIT.

Note the line chokes on the rear of the chassis; these act as a line filter in conjunction with two 0.1- μ f. capacitors. The two chassis shields, with the r-f circuits and the 6L6 plate tank, can be seen in the center of the chassis.



from the power supply ahead of the voltage-regulator circuit.

Only two changes were made in the frequency meter proper. The first change was to remove the lead from the antenna post on the front panel of the meter and then to terminate this lead at the coaxial connector on the rear of the housing for the frequency meter. The other change was to separate the filament circuit from the switch contacts on both phone jacks.

A 60-ma. dial lamp mounted behind a jeweled holder on the panel is used to indicate resonance in the plate tank circuit for the 6L6. This lamp mounting may be seen both in Figures 22 and 24.

The exciter has provision for control of the operation of the v.f.o. from the relay which applies plate voltage to the transmitter. These control terminals are brought out of the back of the chassis. Provision also has been made for using the frequency meter in its normal fashion by throwing a switch on the front panel, which brings the output of the frequency meter to a coaxial connector on the rear of the chassis. This same switch disables the exciter portion of the v.f.o. unit on this switch position. A third position of this switch turns on the whole v.f.o. for spotting in the receiver when the transmitter is turned off.

- C₁, C₂, C₃—0.002- μ f. midget mica
- C₄, C₅—100- μ f. midget mica
- C₆, C₇, C₈, C₉, C₁₀—0.002- μ f. mica
- C₁₁—100- μ f. midget variable
- R₁—68,000 ohms 2 watts
- R₂—330 ohms 2 watts
- R₃—56 ohms 2 watts
- R₄—1000 ohms 2 watts
- R₅—100,000 ohms 2 watts
- R₆—330 ohms 2 watts
- R₇—47 ohms 2 watts
- R₈—1000 ohms 2 watts
- R₉—100,000 ohms 2 watts
- R₁₀—330 ohms 2 watts
- R₁₁—56 ohms 2 watts
- RFC₁, RFC₂—2.5-mh. 125-ma. chokes
- J₁—Key jack
- L₁—48 turns 1" dia., 3" long (B&W no. 3015 coil)
- L₂—7 turns no. 20 hookup wire
- L₃—2 turns no. 20 hookup wire
- I—60-ma. dial lamp

Figure 25.
SCHEMATIC DIAGRAM OF THE R-F AMPLIFIER PORTION OF THE
FREQUENCY-METER/V-F-O UNIT.

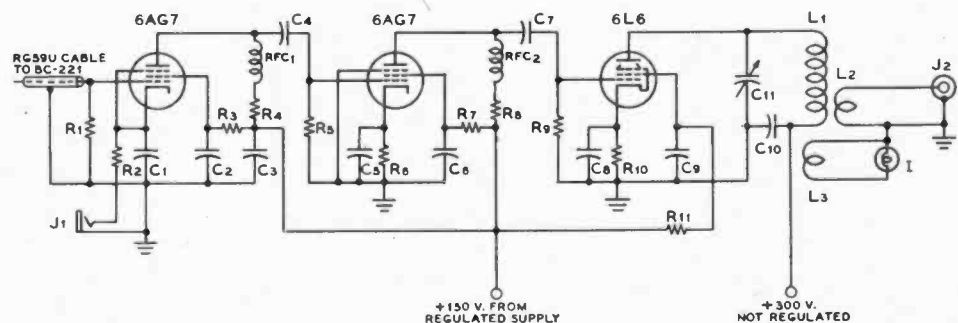

THE "Q" SIGNALS APPLICABLE TO AMATEUR OPERATION

Abbr- viation	Question	Answer
QRA	What is the name of your station?	The name of my station is
QRB	How far, approximately, are you from my station?	The approximate distance between our stations is nautical miles (or kilometers).
QRG	Will you tell me my exact frequency (wavelength) in kc/s (or m)?	Your exact frequency (wavelength) is (or m). kc/s
QRH	Does my frequency (wavelength) vary?	Your frequency (wavelength) varies.
QRI	Is my note good?	Your note varies.
QRJ	Do you receive me badly? Are my signals weak?	I cannot receive you. Your signals are too weak.
QRK	Do you receive me well? Are my signals good?	I receive you well. Your signals are good.
QRL	Are you busy?	I am busy (or I am busy with). Please do not interfere.
QRM	Are you being interfered with?	I am being interfered with.
QRN	Are you troubled by atmospherics?	I am troubled by atmospherics.
QRO	Shall I increase power?	Increase power.
QRP	Shall I decrease power?	Decrease power.
QRQ	Shall I send faster?	Send faster (words per minute).
QRR		Amateur "SOS" or distress call (U.S.A.). Use only in serious emergency.
QRS	Shall I send more slowly?	Send more slowly (words per minute).
QRT	Shall I stop sending?	Stop sending.
QRU	Have you anything for me?	I have nothing for you.
QRV	Are you ready?	I am ready.
QRW	Shall I tell him on kc/s (or m) that you are calling	Please tell kc/s (or m) that I am calling him on m).
QRX	Shall I wait? When will you call me again?	Wait (or wait until I have finished communicating with) I will call you at o'clock (or immediately).
QRZ	Who is calling me?	You are being called by
QSA	What is the strength of my signals (1 to 5)?	The strength of your signals is (1 to 5).
QSB	Does the strength of my signals vary?	The strength of your signals varies.
QSD	Is my keying correct; are my signals distinct?	Your keying is incorrect; your signals are bad.
QSK	Shall I continue with the transmission of all my traffic? I can hear you through my signals.	Continue with the transmission of all your traffic; I will interrupt you if necessary.
QSL	Can you give me acknowledgment of receipt?	I give you acknowledgment of receipt.
QSM	Shall I repeat the last telegram I sent you?	Repeat the last telegram you have sent me.
QSO	Can you communicate with direct (or through the medium of)?	I can communicate with direct (or through the medium of).
QSP	Will you retransmit to free of charge?	I will retransmit to free of charge.
QSU	Shall I send (or reply) on kc/s (or m) and/or on waves of Type A1, A2, A3, or B?	Send (or reply) on kc/s (or m) and/or on waves of Type A1, A2, A3, or B.
QSV	Shall I send a series of V V V ?	Send a series of V V V
QSW	Will you send on kc/s (or m) and/or on waves of Type A1, A2, A3, or B?	I am going to send (or I will send) on kc/s (or m) and/or on waves of Type A1, A2, A3, or B.
QSX	Will you listen for (call sign) on kc/s (or m)?	I am listening for (call sign) on kc/s (or m).
QSY	Shall I change to transmission on kc/s (or m) without changing the type of wave? or Shall I change to transmission on another wave?	Change to transmission on kc/s (or m) without changing the type of wave or Change to transmission on another wave.
QSZ	Shall I send each word or group twice?	Send each word or group twice.
QTA	Shall I cancel telegram No. as if it had not been sent?	Cancel telegram No. as if it had not been sent.
QTB	Do you agree with my number of words?	I do not agree with your number of words; I will repeat the first letter of each word and the first figure of each number.
QTC	How many telegrams have you to send?	I have telegrams for you (or for).
QTH	What is your position in latitude and longitude (or by any other way of showing it)?	My position is latitude longitude (or by any other way of showing it).
QTR	What is the exact time?	The exact time is

Buyer's Guide

Parts Required for Building Equipment Shown in This Book

The parts listed are in most cases those actually used by our laboratory in constructing the models shown. Other parts of equal merit and equivalent electrical characteristics may usually be substituted without materially affecting the performance of the units.

CHAPTER 18

High-Frequency Receiver Construction

Figure 10, page 273

Dual-Channel Signal Amplifier

C₁—Millen air padder
 C₂, C₃, C₁₀, C₁₁, C₁₂—Solar Midget
 C₄, C₅, C₆, C₇, C₈, C₉, C₁₃, C₁₄, C₁₅, C₁₆—Solar CM-30
 C—Millen air padder
 C₁₇, C₁₈—Solar M8-450
 R₁, R₂, R₃, R₄, R₅, R₆, R₇, R₈—Ohmite Little Devil
 R₉, R₁₀—Ohmite Brown Devil
 T₁—Stancor P-6119
 CH—Stancor C-1708
 S₁—Centralab 1473
 L₁—Ohmite Z-1
 Millen 69041 forms for all coils

CHAPTER 19

Converters for the 28-Mc. and 50-Mc. Bands

Figure 3, page 277

28-Mc. 6AK5-6J6 Converter

C₁, C₂—Cardwell ZR-15-AS
 C₃, C₄—National PSE-25
 C₅—National PSE-100
 C₆, C₇, C₈, C₉, C₁₀, C₁₁, C₁₂—Cornell-Dubilier 1W
 C₁₃—National PSR
 R₁, R₂, R₃, R₄, R₅, R₆, R₇—Ohmite Little Devil
 RFC—National R-100
 L₁—National XR-2 form

Figure 7, page 279

Two-Band Converter

C₁, C₂—Cardwell ER-10-AD
 C₃—Hammarlund MC-50-5
 C₄, C₅—National PSR-25
 C₆—National PSR-100
 C₇, C₈, C₉, C₁₀, C₁₁, C₁₂, C₁₃, C₁₄, C₁₅, C₁₆, C₁₇, C₁₈—Cornell-Dubilier 1W
 C₁₉—Cornell-Dubilier 5R
 C₂₀—Centralab
 C₂₁—Cornell-Dubilier 5W
 R₁, R₂, R₃, R₄, R₅, R₆, R₇, R₈, R₉, R₁₀—Ohmite Little Devil
 R₁₁—Mallory
 L₁, L₂, L₃—Amphenol type 24 form
 National XR-50 forms in Amphenol 24 form bases

Figure 10, page 281

Broad-Band Converters

C₁—Centralab CC20Z 5-μfd.
 C₂, C₃, C₄, C₅—Cornell-Dubilier 5W
 C₆, C₇, C₈, C₉, C₁₀—Cornell-Dubilier 1W
 C₁₁—Centralab CC32Z 100-μfd.
 R₁, R₂, R₃, R₄, R₅, R₆—Ohmite Little Devil
 R₇—Ohmite Brown Devil
 RFC—Ohmite Z-1
 S—Centralab 1407
 All coils wound on National type XR-50 coil forms

CHAPTER 20

V-H-F and U-H-F Receiver Construction

Figure 9, page 286

U-H-F Converter

C₁—Cardwell ER-8-BF/5
 C₂—Solar Midget Mica
 C₃, C₄, C₅—Solar CM-30
 R₁, R₂—Ohmite Little Devil
 L₁—National XR-50 form
 Oscillator assembly—Cardwell PL-20,024

CHAPTER 21

H-F Exciters and Low-Power Transmitters

Figure 3, page 288

40-80 Meter Transmitter

C₁—Cornell-Dubilier 5W
 C₂—Cornell-Dubilier 1W
 C₃, C₄—Cardwell MR-260-B5
 C₅—Cornell-Dubilier BR-845
 R₁, R₂, R₃—Ohmite Little Devil
 R₄, R₅—Ohmite Brown Devil
 I—General Electric 40A or 49A
 RFC—National R-100
 T₁—Stancor P-6012
 L₂—Stancor C-1709

Figure 9, page 291

6L6-809 Transmitter

C₁—National ST-75
 C₂—National TMK-100D
 C₃—Centralab CC20Z 10 μfd.
 C₄, C₅—Cornell-Dubilier 5W
 C₆, C₇, C₈, C₉, C₁₀, C₁₁, C₁₂—Cornell-Dubilier 1W
 C₁₃—National STN
 C₁₄—Cornell-Dubilier 4-22020
 C₁₅—Cornell-Dubilier 4-22010
 C₁₆—Cornell-Dubilier 1D
 R₁, R₂, R₃, R₄, R₅—Ohmite Little Devil
 RFC₁, RFC₂—National R-100U
 RFC₃—National R-300U
 L₁—National XR-1 form
 L₂—National AR-16 series
 S₁—Centralab 2505 or 1411

Figure 13, page 294

Bandswitching Exciter

C₁—Cardwell ZR-50-AS
 C₂—Cardwell MR-365-B5
 C₃—Cardwell ZU-140-AS
 C₄—Cardwell ZR-35-AS
 C₅, C₆, C₇, C₈, C₉, C₁₀, C₁₁, C₁₂, C₁₃, C₁₄, C₁₅, C₁₆, C₁₇, C₁₈—Cornell-Dubilier 5W
 C₁₉, C₂₀, C₂₁, C₂₂—Cornell-Dubilier 1W
 C₂₃, C₂₄—Cornell-Dubilier 1W
 C₂₅, C₂₆, C₂₇—Cornell-Dubilier DYR-6011
 C₂₈, C₂₉—Solar M-240
 C₃₀, C₃₁—Tobe PT-SC-2
 R₁, R₂, R₃, R₄, R₅, R₆—IRC AB
 R₇, R₈, R₉, R₁₀, R₁₁, R₁₂—IRC BT-2
 R₁₃—IRC BTS
 R₁₄, R₁₅, R₁₆, R₁₇, R₁₈—IRC BTA
 R₁₉, R₂₀—IRC DG

S₁—Centralab 2515
 S₂, S₃—Centralab 2505
 S₄—Centralab 2513
 T—Thordarson T-22R07
 CH—Thordarson T-20C54
 RFC—National R-100U

Figure 16, page 296

Operating-Table V-F-O Unit

C₁—Centralab CC-35Z 125 μfd.
 C₂—Centralab CC-45Z 250 μfd.
 C₃—Centralab CC-35Z 200 μfd., CC-32Z 50 μfd. and CC-20N 50 μfd. in par.
 C₄—National ST-150
 C₅—National PSR-50
 C₆—Centralab 820-C
 C₇—Centralab CC-32Z 100 μfd.
 C₈, C₉, C₁₀, C₁₁, C₁₂, C₁₃, C₁₄, C₁₅, C₁₆, C₁₇, C₁₈—Solar MW
 R₁, R₂, R₃, R₄—Ohmite Little Devil
 R₅—Ohmite Brown Devil
 R₆—IRC DHA or Ohmite no. 0388
 L₁—National XR-50 form
 L₂, L₃—National XR-2 form
 L₄—National XR-2 form
 T—Stancor P-6010
 CH—Stancor C-1708
 S₁—Centralab 2542
 RFC—National R-100
 Dial—National ACN
 Cabinet—Bud CU-879

Figure 21, page 298

Six-Band V-F-O Unit

C₁—National PSE-25
 C₂—Hammarlund MC-50S
 C₃, C₄, C₅, C₆, C₇, C₈, C₉, C₁₀, C₁₁, C₁₂, C₁₃—Cornell-Dubilier 1W
 C₁₄, C₁₅, C₁₆—Cornell-Dubilier 5W
 R₁, R₂, R₃, R₄, R₅, R₆—Ohmite Little Devil
 R₇, R₈—Ohmite Brown Devil
 M—Marion HM-2
 SW₁—Centralab 1473
 SW₂—Centralab 2505
 L₁, L₂—National XR-50
 Output Turret—B&W BTEL
 Cabinet—Bud 1748

Figure 24, page 299

80-Meter V-F-O

C₁, C₂—Cornell-Dubilier 5W
 C₃, C₄, C₅—Cornell-Dubilier DT-651
 C₆—Hammarlund HFA-100A
 R₁, R₂, R₃, R₄—Ohmite Little Devil
 L—National XR-50
 S₁—Centralab 1415

Figure 27, page 301

FM Exciter Unit

C₁, C₂, C₃, C₄, C₅, C₆, C₇, C₈, C₉, C₁₀, C₁₁, C₁₂—Solar MW
 C₁₃, C₁₄—Hammarlund HFA-140A
 C₁₅—Hammarlund MC-100-M
 C₁₆—Solar M25-25
 C₁₇—Solar DT
 C₁₈, C₁₉—Solar M8-450
 C₂₀, C₂₁—Solar M10-450
 R₁, R₂, R₃, R₄, R₅, R₆, R₇, R₈, R₉, R₁₀, R₁₁, R₁₂, R₁₃, R₁₄, R₁₅, R₁₆, R₁₇, R₁₈, R₁₉, R₂₀, R₂₁, R₂₂, R₂₃—Ohmite Little Devil

- R₁—Ohmite Brown Devil
- R₂—Centralab 72-105
- L₁—Amphenol 24 form
- T₁—Stancor P-6119
- CH—Stancor C-1708
- S₁, S₂—Arrow-H&H toggle

Figure 32, page 304

150-Watt Exciter/Transmitter

- C₁—Millen 19140
- C₂—Millen 19050
- C₃—Millen 12510 suitable
- C₄—Centralab CC20Z 10 μfd.
- C₅, C₇, C₈, C₉, C₁₀, C₁₁, C₁₂, C₁₃, C₁₄, C₁₅, C₁₆, C₁₇, C₁₈, C₁₉, C₂₀, C₂₁, C₂₂—Solar MW
- C₂₃, C₂₄—Solar CM-20
- C₂₅—Solar S-0221
- C₂₆—Solar XQ-2.5-22
- C₂₇, C₂₈, C₂₉—Solar M8-450
- R₁, R₂, R₃, R₄, R₅, R₆, R₇, R₈, R₉, R₁₀, R₁₁, R₁₂—Ohmite Little Devil
- R₁₃—Mallory M50MP
- R₁₄, R₁₅, R₁₆, R₁₇—Ohmite Brown Devil
- RFC₁, RFC₂—Millen 34100
- RFC₃—Millen 34105
- S₁—Centralab 2505
- S₂—Centralab 1411
- S₃, S₄—Arrow-H&H toggle
- T₁—Stancor P-6013
- T₂—Stancor P-3062
- CH—Stancor C-1001
- Meters—Marion model 535N
- H-V Connector—Millen 37001
- Crystal Sockets—Millen
- Grid Coils—Millen 45004 forms
- Plate Coils—Millen 44001 forms for 80, 40 and 20; Millen 40305 plugs for 10 and 6.
- Coil socket—Millen 41305

CHAPTER 22

High-Frequency Power Amplifiers

Figure 7, page 309

Standard Push-Pul. Amplifier

- C₁—Johnson 200ED20
- C₂—Johnson 150DD45
- C₃—N-125
- C₄—Solar MW
- R₁—Ohmite Brown Devil
- RFC—Johnson 752
- Meters—Triplett 421
- Coils—L₁, Johnson 640 series
- L₂, Johnson 660 series
- If over 1500 volts is used the 680 series should be used
- Sockets—Johnson 209B 4-prong
- Johnson 225 for grid coils
- Insulators—Johnson 42 and 55
- Cone insulators—Johnson 501
- Hi-Volt Term.—Millen 37001
- Connection Strip—Jones 4-140
- Dials—Millen 100008

Figure 19, page 316

Push-Pull 807 Amplifier

- L₂—Millen 44000 series coils with 44500 swinging antenna link and jack base
- C₁—Millen 24100 variable capacitor
- C₂—Millen 12076 variable capacitor
- R₁, R₂—Ohmite Brown Devil
- R₃, R₄, R₅—Ohmite Little Devils
- M—Simpson model 27, 0-300 ma. rectangular case
- RFC—Millen 34105 r.f. choke with insulator
- T—U.T.C. S-55 transformer
- Two Millen 31002 2 1/2-inch ceramic standoff insulators. Millen 800009 shield, shelf and socket for 807's. Grid coils wound on Millen 45005 coil forms. Grid coil socket is Millen 33005. Input and output terminals Millen 37302. Dials, Millen 100009, 2 3/4" dia. Cone insulators Millen 31011.

Figure 22, Page 317

813 Amplifier

- C₁—Johnson 100D70
- C₂—Cardwell ZR-15-AS
- C₃—Sangamo A-2

- C₁, C₂, C₃—Cornell-Dubilier 1W
- C₄—Sangamo A-25
- R₁—Ohmite Brown Devil
- RFC—Johnson 752
- T—Thordarson T-19F96

CHAPTER 23

V-H-F and U-H-F Transmitters

Figure 4, page 321

60-Watt FM Transmitter

- C₁, C₂—National PSE-140
- C₃, C₄—National PSE-75
- C₅, C₆—Hammarlund HFD-30X
- C₇, C₈, C₉, C₁₀, C₁₁, C₁₂, C₁₃, C₁₄, C₁₅, C₁₆, C₁₇, C₁₈, C₁₉, C₂₀, C₂₁, C₂₂, C₂₃, C₂₄, C₂₅, C₂₆, C₂₇—Cornell-Dubilier 1W
- C₂₈, C₂₉, C₃₀, C₃₁, C₃₂, C₃₃—Cornell-Dubilier 5W
- C₃₄—National TMS-250 suitable
- C₃₅, C₃₆, C₃₇, C₃₈, C₃₉, C₄₀—Cornell-Dubilier BR
- C₄₁—Cornell-Dubilier DT
- C₄₂—Cornell-Dubilier TJU
- R₁, R₂, R₃, R₄, R₅, R₆, R₇, R₈, R₉, R₁₀, R₁₁, R₁₂, R₁₃, R₁₄, R₁₅, R₁₆, R₁₇, R₁₈, R₁₉, R₂₀, R₂₁, R₂₂, R₂₃, R₂₄, R₂₅, R₂₆, R₂₇, R₂₈, R₂₉, R₃₀, R₃₁, R₃₂, R₃₃, R₃₄, R₃₅—Ohmite Little Devil
- R₃₆, R₃₇, R₃₈, R₃₉, R₄₀—Ohmite Brown Devil
- R₄₁—Mallory type N
- T₁—Stancor P-3064
- T₂—Stancor P-8041
- T₃—Stancor P-6133
- CH₁—Stancor C-2307
- CH₂—Stancor C-1001
- S₁—Centralab 1405
- S₂—Centralab 2507
- S₃, S₄—Arrow-H&H toggle
- MA—Simpson Model 127
- Coils—One-inch dia. coil forms National XR-2; pre-wound inductors cut from B&W 3011 "Miniductor"

Figure 7, page 323

829B Amplifier-Tripler Unit

- C₁—Hammarlund HFD-30X
- C₂—Cardwell ER-8-BF/S
- C₃, C₄, C₅, C₆—CD type 1W
- R₁, R₂—Ohmite Brown Devil
- R₃, R₄—Ohmite Little Devil
- T—U.T.C. FT-4

Figure 10, page 324

3C24 24G Amplifier

- C₁—Hammarlund HFD-30X
- C₂—Cardwell NP-50-DD
- C₃, C₄, C₅—Cornell-Dubilier 1W
- R₁—Ohmite Brown Devil
- R₂, R₃—Ohmite Little Devil
- MA—Simpson 227
- T—Stancor P-3064

Figure 14, page 326

500-Watt Amplifier

- C₁—Hammarlund HFBD-100-C
- C₂, C₃, C₄, C₅, C₆, C₇, C₈—Solar CM-30
- C₉, C₁₀, C₁₁—Solar XQ
- C₁₂—Solar XS
- C₁₃—Solar MW
- R₁—Ohmite Brown Devil
- R₂—Ohmite Little Devil

Figure 17, page 328

425-Mc. Transmitter

- C₁, C₂, C₃, C₄—Solar M8-450
- C₅, C₆—Solar M25-25
- C₇—Solar MW
- C₈—Solar S-0238
- R₁, R₂, R₃, R₄, R₅, R₆, R₇, R₈, R₉, R₁₀, R₁₁, R₁₂—Ohmite Little Devil
- R₁₃—Ohmite Brown Devil
- R₁₄—Mallory cat. no. N
- T—Stancor P-6013
- CH₁—Stancor C-1708
- CH₂—Stancor C-1001
- SW₁, S₂—Arrow-H&H toggle

Figure 21, page 330

20-Watt Mobile Transmitter

- C₁—Hammarlund APC-50
- C₂—Hammarlund MCD-100-M

- C₁—Hammarlund MCD-35-MX
- C₂—Centralab CC20Z 10 μfd.
- R₁, R₂, R₃, R₄, R₅, R₆—Ohmite Little Devil
- R₇—Ohmite Brown Devil
- RFC₁, RFC₂—National R-100U
- Vibrator Pack—Mallory VP-552
- L₁—National XR-2 form

Figure 24, page 332

50-Watt Transmitter

- C₁—Hammarlund APC with shaft
- C₂—Hammarlund HFD-100
- C₃—Hammarlund HFD-30X
- C₄, C₅—Solar MT
- C₆, C₇, C₈, C₉, C₁₀, C₁₁, C₁₂, C₁₃, C₁₄, C₁₅, C₁₆, C₁₇—Solar MW
- C₁₈, C₁₉—Solar M8-450
- C₂₀—Solar M25-25
- R₁, R₂, R₃, R₄, R₅, R₆, R₇, R₈, R₉, R₁₀, R₁₁, R₁₂, R₁₃, R₁₄, R₁₅, R₁₆, R₁₇, R₁₈, R₁₉, R₂₀—Ohmite Little Devil
- R₂₁, R₂₂, R₂₃—Ohmite Brown Devil
- R₂₄—Wound from res. wire
- R₂₅—Mallory type N
- T₁—Peerless A-4078X
- T₂—Peerless A-4099X
- T₃—Peerless M-4081Q
- S₁—Centralab 1405 or 2505
- M—Simpson model 127
- L₁, L₂—Amphenol no. 24 coil form
- L₃—National AR16-10C for 28-Mc. band and 6-meter coil supported by PB-16 ceramic plug

CHAPTER 24

Speech and Amplitude-Modulation Equipment

Figure 3, page 334

8-Watt Amplifier

- C₁, C₂, C₃—Solar M25-25
- C₄, C₅, C₆, C₇—Solar M8-450
- C₈—Solar S-0221
- C₉—Solar S-0240
- C₁₀—Solar S-0230
- R₁, R₂, R₃, R₄, R₅, R₆, R₇, R₈, R₉, R₁₀, R₁₁, R₁₂—Ohmite Little Devil
- R₁₃, R₁₄—Ohmite Brown Devil
- T₁—Stancor A-4702
- T₂—Stancor P-6012
- CH—Stancor C-1709

Figure 6, page 336

High-Quality Amplifier

- C₁, C₂, C₃—Solar M25-25
- C₄—Solar P-1821
- C₅—Solar M8-450
- C₆—Solar DT
- C₇—Solar MT
- C₈, C₉—Solar XDC
- C₁₀, C₁₁—Solar MW
- C₁₂—Solar M8-525
- C₁₃—Mallory
- C₁₄—Solar M30-150
- C₁₅—Mallory
- R₁, R₂, R₃, R₄, R₅, R₆, R₇, R₈, R₉, R₁₀, R₁₁, R₁₂, R₁₃, R₁₄, R₁₅, R₁₆, R₁₇, R₁₈, R₁₉, R₂₀—Ohmite Little Devil
- R₂₁—Mallory type N
- R₂₂—I.R.C. AB or Ohmite Brown Devil
- R₂₃—I.R.C. DHA
- R₂₄, R₂₅, R₂₆—Ohmite Brown Devil
- T₁—U.T.C. R-13
- T₂—U.T.C. PVM-2
- CH—U.T.C. PA-40
- S₂—Centralab 1413

Figure 9, page 337

250-Watt Class B Modulator

- C₁, C₂—Cornell-Dubilier 4-52020
- C₃, C₄—Cornell-Dubilier EB-8800
- R₁, R₂, R₃—Ohmite Brown Devil
- S—Centralab 2544
- T₁—Thordarson T-19D05
- T₂—Thordarson T-11M77
- T₃—Thordarson T-19F99 for 811's, T-19F94 for 5514's or T2-40's, or Peerless F-8512B for either tube type
- CH₁—Thordarson T-13C27
- CH₂—Thordarson T-68C07

(Continued on Page 459)

National

RADIO PRODUCTS

1948



NATIONAL COMPANY, INC.
MALDEN, MASSACHUSETTS, U.S.A.

Modern Communications Receivers

by **National**
EST. 1914



Building communications receivers to the standards set by our experienced engineering department for over two decades, National has prided itself on the performance of its receivers in the specialized markets for which they have been designed.

National post-war receivers incorporate the newest circuit techniques and offer the operator the maximum value per dollar spent.

National standards are upheld in the 1948 receivers shown on these pages.

Your National distributor will have these modern receivers on display at your favorite radio store.

Known and used by hams the world over for 13 years, the old HRO now has a new successor — the HRO-7 — incorporating every one of its strong points and adding a number of modern refinements. Still present is excellent signal noise ratio and image rejection.

Brand new features include: automatic adjustable-threshold noise limiter; stabilized voltage supply for new high frequency oscillator; tone switch; accessory connector socket; and radio-phono switch.

Special improvements have been added, such as slide-

rule type calibration on coil sets and lever-type handles to facilitate coil changing. The HRO-7 is housed in a streamlined gray cabinet with matching speaker.

FEATURES:

- Frequency Range of 50 to 430 and 480 to 30,000 KC.
- AM phone and code reception with maximum bandwidth.
- Accessory Connector Socket.
- New automatic noise limiter with variable threshold.
- 5 position wide range crystal filter with phasing control.



HRO-7 complete with standard coils for 1.7 to 30 MC coverage, power supply and 8" speaker... Amateur Net \$311.36.

HRO-7C Deluxe Receiver Combination, Black Walnut Finish, Mounted on Table Each 21 inches high... Amateur Net... \$351.51

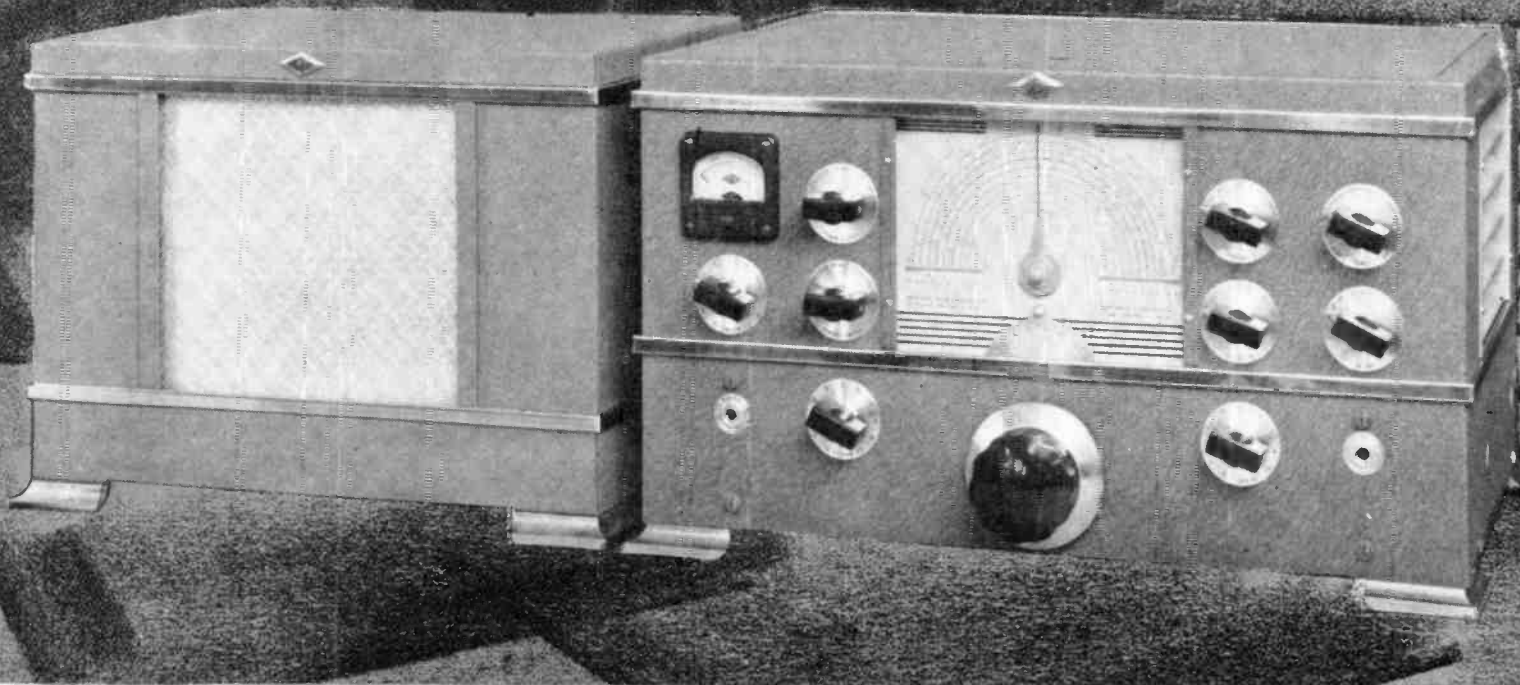

**THE
NC-2-40D**

For hams who appreciate engineering, the NC-2-40D will be a thoroughly satisfying possession. Used by airlines and communications companies throughout the world, the NC-2-40D has become famous for its ability to pick up weak signals, and its fine stability.

A 10" speaker and a hi-fidelity push-pull audio system afford tone quality that will please the most critical operator. A series valve noise limiter minimizes noise pulses.

This is a receiver for the ham who demands superb performance.

FEATURES:

- Frequency Coverage from 490 to 30,000 kc. Four Amateur Bands (10-11, 20, 40 and 80 meters) with uniform bandspread.
- 8 Watts of undistorted audio.
- 5 Position wide range Crystal Filter.
- Single control for band changing and tuning.
- Temperature Compensation.
- Amateur Net (with 10" speaker)...\$241.44.

**THE NEW
NC-57**

To meet the needs of the many hams who have asked for a sensitive, first-rate bandswitching receiver in the lower price bracket, complete with speaker and power supply in one cabinet, the National Company has developed the brand new NC-57.

Although moderate in price, this little receiver incorporates features usually found in the more expensive models. Excellent tone quality, sensitivity, selectivity and high signal-to-noise ratio afford a level of performance which will be appreciated by any operator. A superb receiver for the beginner, the NC-57 will be found ideal as a standby in any amateur station.

FEATURES:

1. Continuous frequency coverage from 550 kc to 55 mc. Bandswitching in 5 ranges. Bandspread tuning at any frequency.
2. Seven tube superheterodyne (plus rectifier and voltage regulator).
3. Automatic Noise Limiter.
4. Built-in loudspeaker and A.C. power supply.
5. R. F. stage with panel controlled antenna trimmer.
6. Operates from 105-130 volts, 50-60 cycles A.C. (Provision for battery operation.)
7. Housed in a streamlined gray cabinet. AMATEUR NET...\$89.50



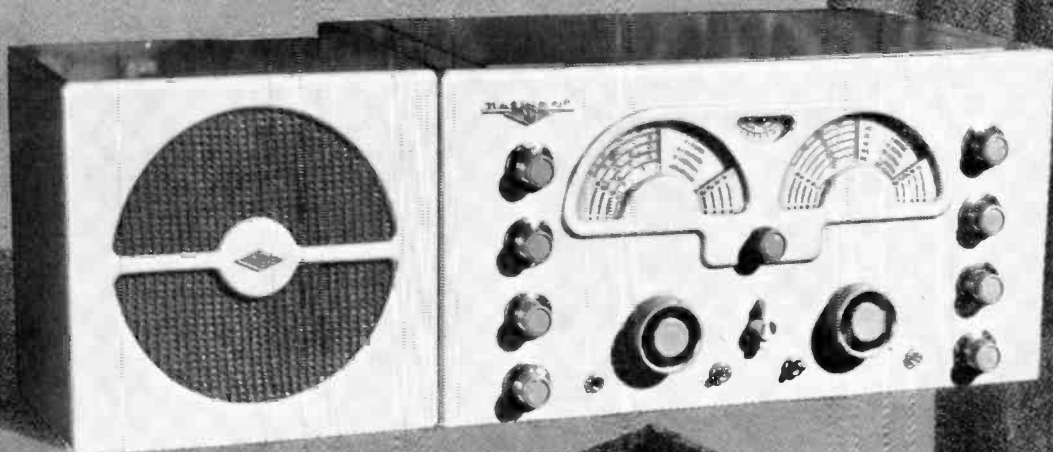

NATIONAL NC-173

A new and versatile receiver, popularly priced, the new NC-173 has received favorable comment on the ham bands from operators who have found it stepped up their percentage of successful QSO's.

The sensitivity and stability of the NC-173 will not only increase your traffic, but will add much to your operating pleasure.

OUTSTANDING FEATURES:

- Frequency Coverage from 540 KC. to 31 MC. plus 48-56 MC.
- Calibrated Amateur Bandspread on 6, 10-11, 20, 40, and 80 meter bands.
- 5 Position Wide Range Crystal Filter.
- Double-Diode Automatic Noise Limiter for Both Phone and C.W. Reception.
- A.V.C. for both Phone and C.W. Reception.
- S Meter with Adjustable Sensitivity for Phone and C.W.
- A.C. Powered — 110/120 or 220/240 volts, 50/60 Cycle.
- Amateur Net (with speaker) — \$189.50.

HFS

An up-to-date successor to the famous National 1-10, the HFS is a new v.h.f. superheterodyne receiver with a super-regenerative second detector. The frequency range of the HFS is 27 to 250 mc., continuous coverage with six sets of coils.

The model HFS is capable of receiving CW and AM or FM signals, and is readily adaptable to portable or mobile operation. An antenna trimmer control is conveniently located on the front panel.

The HFS is extremely versatile in v.h.f. operation for an i.f. output jack is incorporated, permitting it to be used as a converter in conjunction with any conventional superhet receiver which tunes 10.7 mc. As a converter, the HFS and superhet combination results in dual conversion type superheterodyne operation with all its advantages, including excellent image rejection at all frequencies from 27 to 250 mc.

See your National Distributor for Amateur Net Price.



Modern Radio Components

by **National**
EST. 1914

National radio components have been standardized in radio circuits for many years. They have been voted the favorite brand by thousands of amateurs and the National NC signature has become a guarantee of quality.

Listed in these few pages are typical National products. National's 1948 complete

catalog of radio products, available in 1947, will feature new items, designed for present-day applications. In addition, hundreds of components will be listed and recognized as repeat performers by the designer or builder of radio equipment.

Get your copy of the new National catalog from distributor or write direct to factory.

NEW NATIONAL MULTI-BAND TANK

FEATURES

- Tunes amateur bands from 80 to 10 meters with single 180° rotation of capacitor from front-of-panel.
- Link pick-up coil matches impedances up to 600 ohms.
- Split-stator capacitor rated at 1500 volts peak.
- Input 100 watts for push-pull or balanced single-ended operation.
- Dimensions 7 1/2" long — 7" high — 3" wide.
- Rugged construction with ceramic insulation.

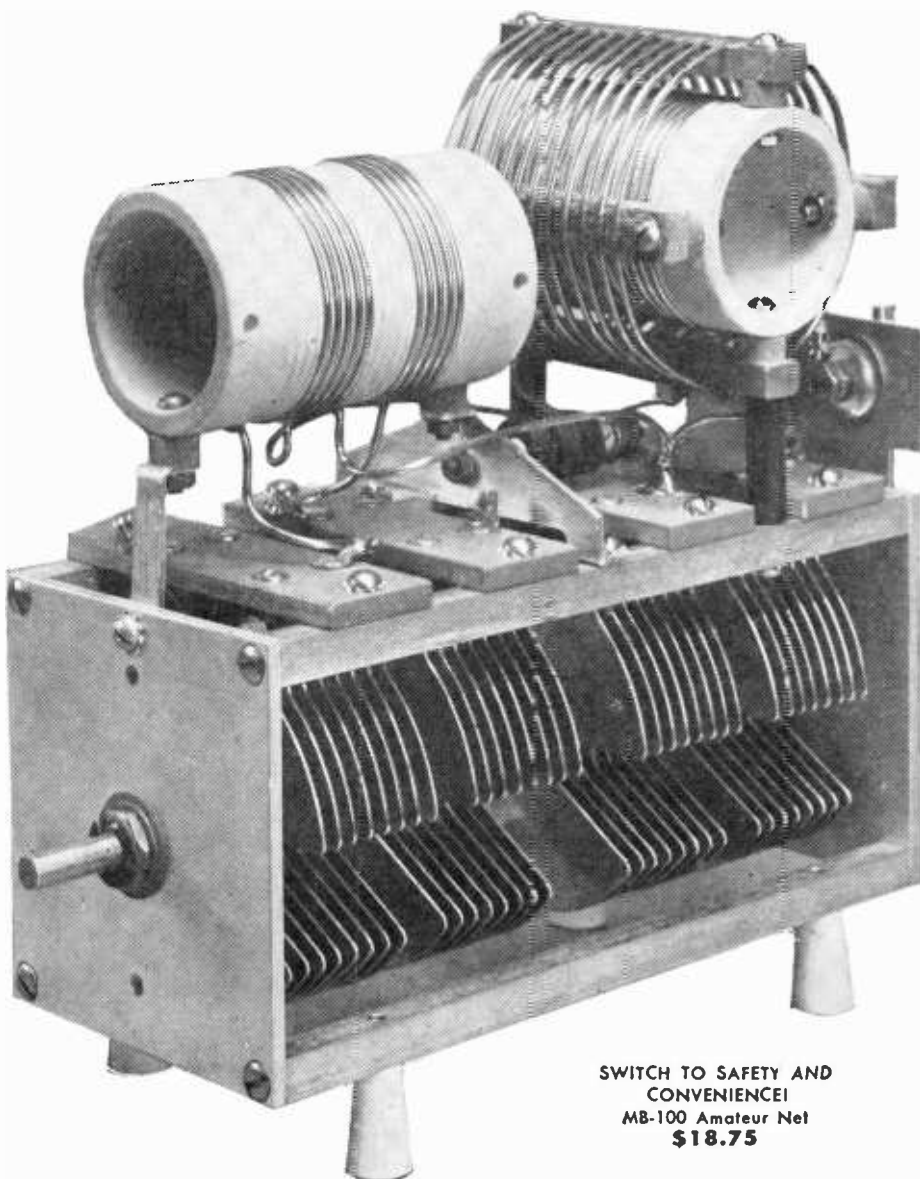

SWITCH TO SAFETY AND
CONVENIENCE!
MB-100 Amateur Net
\$18.75

NATIONAL

DIRECT CALIBRATION DIALS

For complete line
see National 1948
catalog

1. Supplementing National's Famous ACN Dial — A Whole New Line of Dials Designed for Every Amateur's Requirements. Each one incorporates the noted Velvet-Vernier Mechanism.

2. With the introduction of the ICN, SCN and MCN dials, National has recognized and met the requirements of the amateur for a versatile line of dials for every size and shape of rig. All of these dials embody the same 5:1 drive ratio Velvet-Vernier mechanism that has made the ACN dial the standard of comparison among constructors everywhere. No other line of dials is so complete or permits such precision tuning.

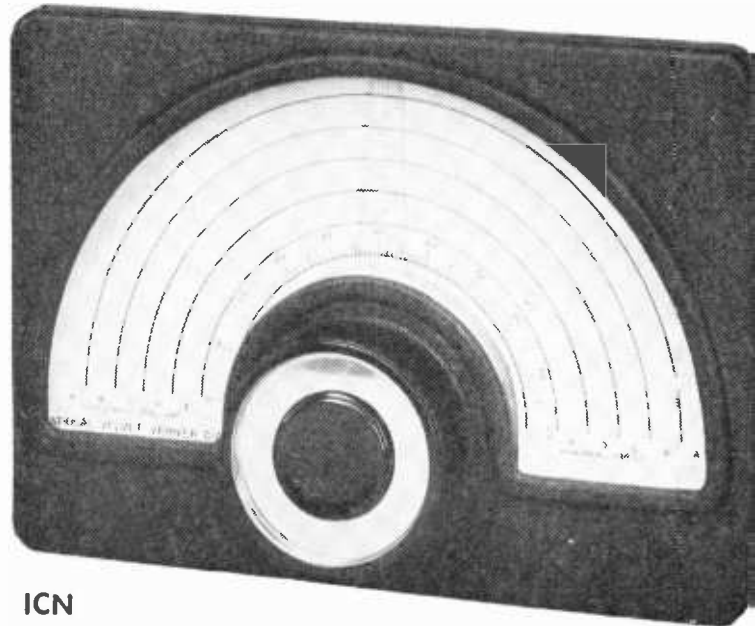

ICN

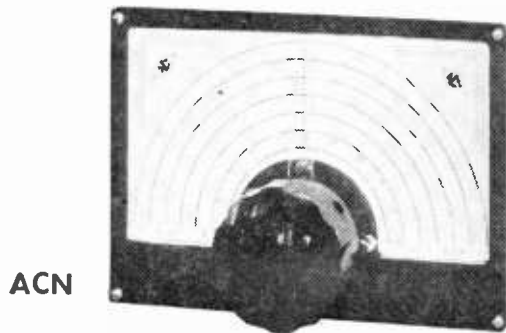

ACN

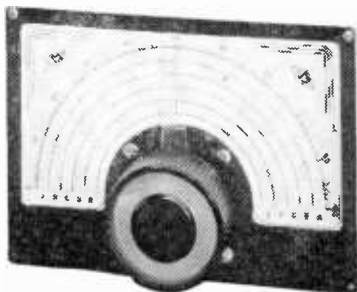

SCN

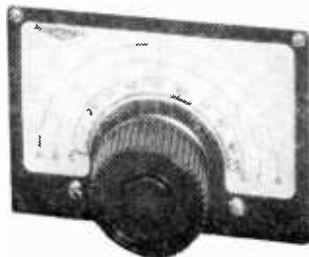

MCN

3. The ICN dial meets those hundreds of requests from amateurs the world over for an illuminated ACN dial. Two dial light brackets are mounted on the top rear corners of the dial and provide efficient and even illumination on all bands. The dial scale has been blanked out in semi-circular shape to prevent shadow casting. Dial scales are the same as those used on the ACN dial. Amateur Net. \$6.00

4. The SCN dial provides the same dial scales as the ACN dial but in a reduced size. It is used where economy of panel-mounting space is desirable and where a smaller dial would be out of proportion with the size of the panel. A truly professional appearance can now be given your rig. Amateur Net \$3.00

5. The MCN dial has been scaled down to lend itself ideally to mobile installations and small converters and tuners. It may also be mounted on the standard 3-7/32" rack panel where such mounting may be desirable. The dial provides three calibrating scales and a 0-100 logging scale. On the rear side of the dial, the mechanism extends 1/4" below the dial frame. Amateur Net. \$2.70

6. See this complete line of dials and other precision National parts at your nearest National distributor. Write to us direct for any information you may desire.



NATIONAL TRANSMITTING CONDENSERS

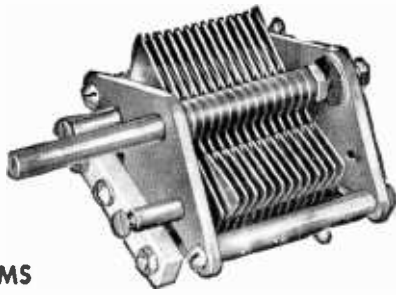

TMS

Maximum capacity of TMS series range from 35 mmfd. to 300 mmfd. split-stator models available.

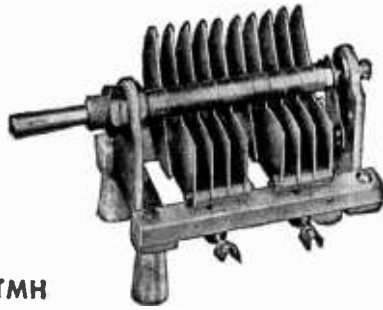

TMH

Maximum capacity of TMH series range from 35 mmfd. to 100 mmfd. split-stator models available.

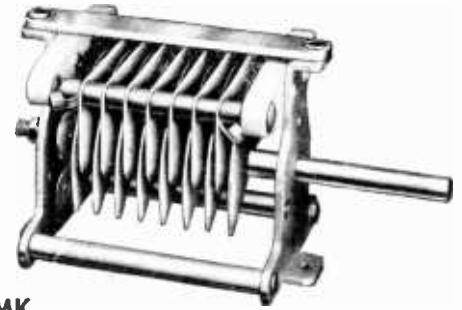

TMK

Maximum capacity of TMK series range from 35 mmfd. to 250 mmfd. split-stator model available.

Series	Capacity	Minimum Capacity	Length	Air Gap	Peak Voltage	No. of Plates	Catalog Symbol	List Price
TMS	See Catalog	See Catalog	3"	.026" .065"	1000v. 2000v.	See Catalog	See Catalog	See Catalog
TMH	See Catalog	See Catalog	3 3/8" 5 1/8"	.085" .180"	3500v. 6500v.	See Catalog	See Catalog	See Catalog
TMK	See Catalog	See Catalog	2 3/8" 4 7/8"	.047"	1500v.	See Catalog	See Catalog	See Catalog
TMC	See Catalog	See Catalog	3" 6 3/8"	.077"	3000v.	See Catalog	See Catalog	See Catalog
TMA	See Catalog	See Catalog	4 1/8" 12 7/8"	.171" .359"	6000v. 12,000v.	See Catalog	See Catalog	See Catalog
TML	See Catalog	See Catalog	8 1/8" 18 1/8"	.469" .719"	15,000v. 20,000v.	See Catalog	See Catalog	See Catalog

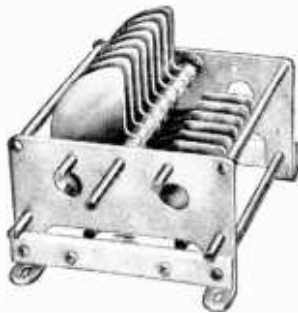

TMC

Maximum capacity of TMC series range from 50 mmfd. to 300 mmfd.

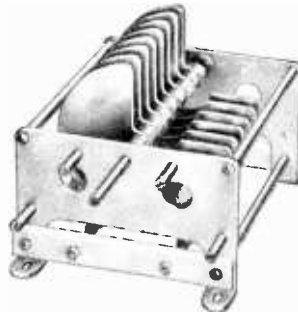

TMA

Maximum capacity of TMA series range from 50 mmfd. to 300 mmfd.

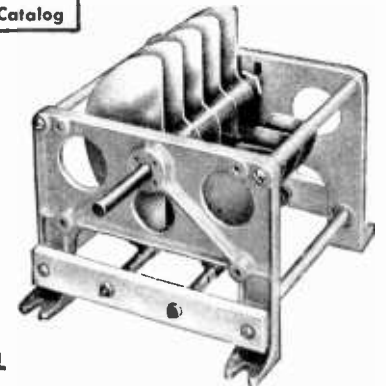

TML

Maximum capacity of TML series range from 50 mmfd. to 500 mmfd.

NATIONAL NEUTRALIZING CONDENSERS

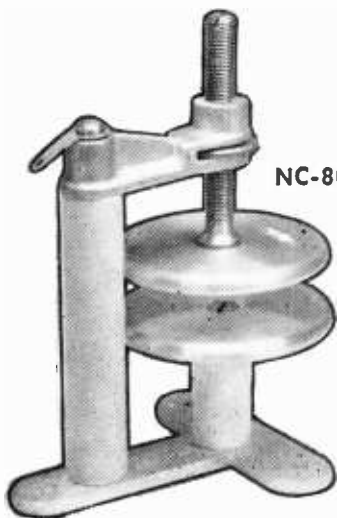

NC-800A

NC-800A — The NC-800A disk-type neutralizing condenser is suitable for the RCA-800, 809, 35TG, HK-54, 5514 and similar tubes. It is equipped with a clamp to lock its setting. The chart below gives capacity and air gap for different settings.

NC-75 — For 811, 812 etc.

NC-150 — For HK354, 250TH etc.

NC-500 — For WE-251, 450TH, 450TL, 750TL etc.

'Disks are aluminum, insulation steatite.

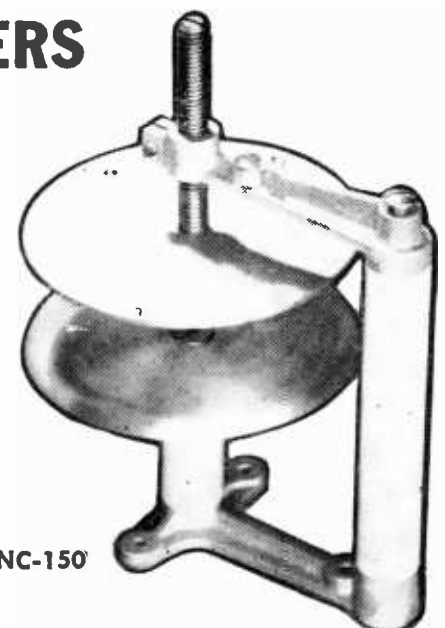

NC-150

NATIONAL RF CHOKES

For complete line see National 1948 catalog

Makers of R.F. Chokes for every application, some of National's popular amateur chokes are listed.



Type	Inductance	Current Rating	DC Resistance	Inductance Tolerance	Amateur Net
R-33	10. UH	33 MA.	1.0 Ohms ± 10%	10%	\$.35
R-50	2.5 MH	50 MA.	40. Ohms ± 10%	10%	.35
R-60	4.0 UH	500 MA.	.139 Ohms ± 10%	10%	.35
R-100	2.5 MH	125 MA.	42. Ohms ± 10%	10%	.35
R-100-S	2.5 MH	125 MA.	11. Ohms ± 10%	10%	.42
R-100-U	2.5 MH	125 MA.	41. Ohms ± 10%	10%	.42
R-300	1.0 MH	300 MA.	10. Ohms ± 10%	10%	.35
R-300	2.5 MH	300 MA.	17.5 Ohms ± 10%	10%	.35
R-300-S	1. MH	300 MA.	11. Ohms ± 10%	10%	.42
R-300-S	2.5 MH	300 MA.	7.5 Ohms ± 10%	10%	.42
R-300-U	1. MH	300 MA.	10. Ohms ± 10%	10%	.42

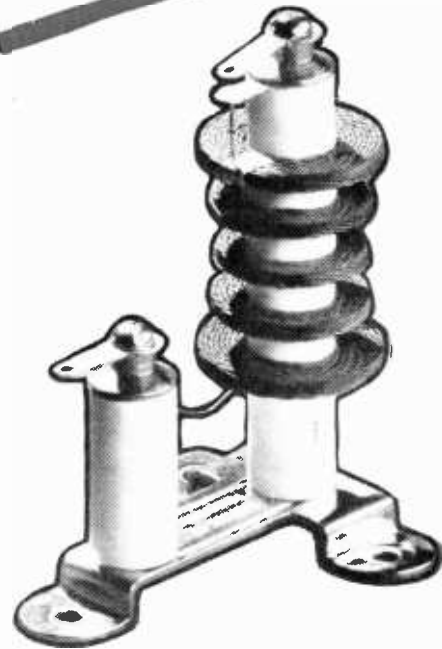

NATIONAL HIGH-FREQUENCY PARTS

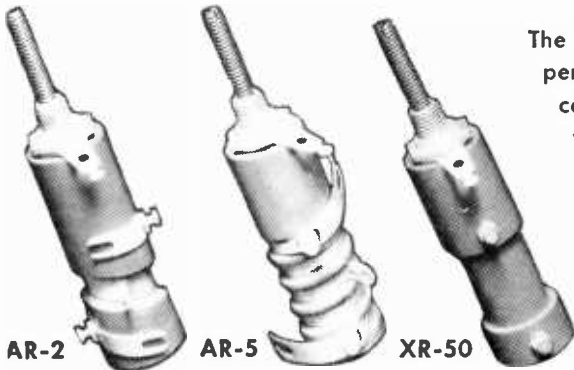

The AR-2 and AR-5 coils are high Q permeability tuned RF coils. The AR-2 coil tunes from 75 Mc. to 220 Mc. with capacities from 100 to 10 mmfd. The AR-5 coil tunes from 37 Mc. to 110 Mc. with capacities from 100 to 10 mmfd.
 AR-2 High Frequency Coil — Amateur Net \$1.71
 AR-5 High Frequency Coil — Amateur Net \$1.46

The XR-50 coil forms may be wound as desired to provide a permeability tuned coil. The form winding length is $\frac{1}{8}$ " and the form winding diameter is $\frac{1}{2}$ inch. The iron slug is $\frac{3}{8}$ " dia, by $\frac{1}{2}$ " long. XR-50 — Amateur Net \$1.00

The XOS tube shield is a two piece shield for the Miniature Button 7 Pin base tubes. The shield is available in three sizes corresponding to the $1\frac{3}{8}$ ", $1\frac{1}{2}$ " and 2" tube body heights.

- XOS-1 For $1\frac{3}{8}$ " high tube body — Amateur Net. \$.48
- XOS-2 For $1\frac{1}{2}$ " high tube body — Amateur Net. \$.48
- XOS-3 For 2" high body — Amateur Net \$1.48



XOS

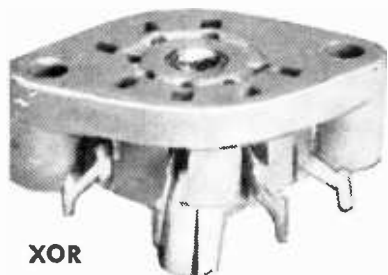

XOR

The .OR Socket is the same as the XOA Socket except that the contacts extend radially from base of socket XOR — Amateur Net. . . \$1.50

Space limitations allow presentation of very few National

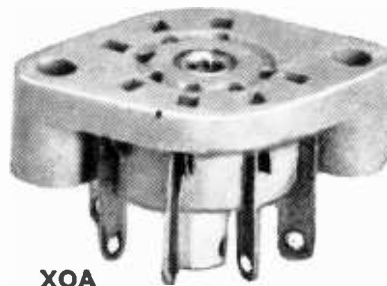

XOA

The XOA Socket is a socket for the Miniature Button 7 Pin base tubes. Low loss mica filled bakelite insulation. Mounts with two 4-40 screws. Socket contacts extend axially from base of socket.

XOA — Amateur Net \$1.50

products. National also manufacturers and distributes: Precision Condensers and Micrometer Dials; Receiving and Miniature Condensers; Transmitter Coils, Forms and Tanks; I.F. Transformers; Low-Loss Sockets, Insulators, Ceramics and Couplings.

These are all listed in National's 1948 catalog — available at your radio store or direct from the factory.



(Continued from Page 450)

Figure 12, page 339

Bias Pack and Grid Modulator

- C₁, C₂, C₃—Cornell-Dubilier DYC
- C₄—Cornell-Dubilier BR-502
- R₁, R₂, R₃, R₁₁—Ohmite Little Devil
- R₄—Mallory-Yaxley
- R₅, R₆, R₇, R₈—Ohmite Brown Devil
- R₉, R₁₀—Mallory M70MP
- T₁—Stancor A-4351
- T₂—Stancor P-6144
- T₃—Stancor P-6165
- L₁, L₂—Stancor C-1001
- SW—Centralab 1415
- RY—Advance or Guardian
- Rect—Selenium Corp. of Amer.

Figure 16, page 341

Clipper-Filter Speech Amplifier

- C₁, C₂, C₃—Solar M25-25
- C₄, C₅, C₁₁—Solar MW
- C₇, C₁₀, C₁₂—Solar M8-450
- R₁, R₂, R₃, R₄, R₅, R₇, R₈, R₉, R₁₀, R₁₁, R₁₂, R₁₃, R₁₄, R₁₅, R₁₆, R₁₇, R₁₈, R₁₉, R₂₀—Ohmite Little Devil
- R₂₁—I.R.C. D-13-133
- R₂₂—I.R.C. D-13-128
- T₁—U.T.C. LS-10X
- T₂—U.T.C. A-25
- S₁—Centralab 1462
- P₁—Amphenol 91-9C3F
- P₂—Jones 3-141

**CHAPTER 25
Power Supplies**

Figure 21, page 358
1250-Volt Power Supply

- C₁, C₂—Cornell-Dubilier TJL-15020
- R₁—Ohmite 0420
- T₁—U.T.C. S-64
- T₂—U.T.C. S-46 may be used
- S₁—Arrow-H&H
- S₂—Centralab 2542

Figure 26, page 360

2000-Volt/1000-Volt Power Supply

- C₁, C₂—Cornell-Dubilier TJU-20020
- C₃, C₄—Cornell-Dubilier TJU-15020
- R₁—Ohmite 0620
- R₂—Ohmite 0969
- CH₁—Thordarson T-19C36
- CH₂—Thordarson T-19C38
- T₁—Thordarson T-19P63
- T₂—U.T.C. S-71
- TS—Advance 300
- RY—Advance 965B
- HCB₁, HCB₂—Heinemann

CHAPTER 26

Transmitter Construction

Figure 4, page 362

Final Amplifier and Modulator of De-Luxe One-Kw. Transmitter

- C₁, C₂—Hammarlund HFBD-100-C
- C₃—Cardwell ZR-25-AS
- C₄—B&W CX-59A
- C₅, C₆, C₇, C₈, C₉, C₁₀, C₁₁, C₁₂, C₁₃, C₁₄—Cornell-Dubilier 4
- C₁₅—Cornell-Dubilier 6
- C₁₆—Cornell-Dubilier BR
- R₁—Ohmite Brown Devil
- R₂—Ohmite 0613
- RFC₁—National R-100U
- L₁, L₂, L₃, L₄—B&W BCL or JTCL
- L₅—B&W HDVL
- T₁—U.T.C. PA-59AX
- T₂—Electro-Engineering Works

Figure 5, page 363

Exciter Unit of De-Luxe One-Kw. Transmitter

- C₁—National ST-100
- C₂—National PSE-25
- C₃, C₄, C₅—Cornell-Dubilier 5W
- C₆, C₇, C₈, C₉, C₁₀, C₁₁, C₁₂, C₁₃, C₁₄—Cornell-Dubilier 1W
- C₁₅—Cornell-Dubilier 1W
- R₁, R₂, R₃, R₁₁, R₁₂—I.R.C. BTA
- R₄, R₅, R₆, R₇, R₈—I.R.C. BT-2
- R₉, R₁₀, R₁₃—I.R.C. DG

- R₇, R₈, R₁₀—I.R.C. AB
- RFC—National R-100U
- S₁—Centralab 2511
- S₂—Centralab 2505
- M₁—Supreme Model 2100

Figure 6, page 363

Power Supply and Control Circuits for the One-Kw. Transmitter

- C₁, C₂, C₃, C₄, C₅—Cornell-Dubilier BR
- C₆, C₇—Cornell-Dubilier TJU
- C₈, C₉—Sprague oil-filled
- R₁—Ohmite 0568
- R₂—Ohmite 0962
- R₃—Ohmite 0967
- R₄—Ohmite 0925
- T₁—U.T.C. S-59
- T₂, T₃—U.T.C. FT-4
- T₄—Stancor P-8042
- T₅—Stancor P-3024
- T₆—Electro-Engineering Works
- T₇—Kenyon T-389
- L₁, L₂—Stancor C-1703
- L₃—Stancor C-1720
- L₄—U.T.C. PA-109
- M₁, M₂, M₃—Supreme Instrument
- K₁, K₂—Allen-Bradley B-300
- K₃—Advance 400
- TD₁—Advance 300

Figure 10, page 366

R-F Chassis of the 807 Transmitter

- C₁—National TMS-250 suitable
- C₂—National ST-140 suitable
- C₃—National ST-100 suitable
- C₄, C₅—National TMC-250
- C₆, C₇, C₈, C₉, C₁₀, C₁₁, C₁₂, C₁₃, C₁₄, C₁₅, C₁₆, C₁₇—Cornell-Dubilier 1W
- C₁₈, C₁₉, C₂₀—Cornell-Dubilier 5W
- C₂₁—National PSR-25
- C₂₂—Cornell-Dubilier 4
- R₁, R₂, R₃, R₄, R₅, R₆, R₇, R₈, R₉, R₁₀, R₁₁, R₁₂, R₁₃, R₁₄, R₁₅, R₁₆—Ohmite Little Devil
- RFC₁—National R-100U
- RFC₂—National R-300U
- L₁, L₂, L₃—National XR-2 form
- L₄—National XR-13 form
- L₅—National XR-13A form
- S₁—Centralab 2543
- S₂—Centralab 2517
- S₃—Centralab 1473
- Meter—Triplett 421 0-300 ma. d.c.

Figure 11, page 366

V.F.O. Unit of the 807 Transmitter

- C₁—Centralab CC32Z 100 μfd.
- C₂—Centralab CC45Z 350 μfd. and Centralab CC25N 75 μfd.
- C₃—Centralab 820C
- C₄—National ST-75

Figure 12, page 367

Crystal Calibrator-Audio Amplifier of the 807 Transmitter

- C₁, C₂, C₃—Solar M25-25
- C₄, C₅—Solar M8-450
- C₆, C₇, C₈, C₉—Solar DT
- C₁₀, C₁₁, C₁₂, C₁₃—Solar MW
- R₁, R₂, R₃, R₄, R₅, R₇, R₈, R₉, R₁₀, R₁₁, R₁₂, R₁₃, R₁₄, R₁₅, R₁₆, R₁₇, R₁₈, R₁₉, R₂₀, R₂₁, R₂₂, R₂₃—Ohmite Little Devil
- R₂₄—Mallory N
- X—James Knights H-16
- T₁—U.T.C. S-18
- L—Miller Mfg. Co.

Figure 13, page 367

Power Supply of 807 Transmitter

- C₁, C₂, C₃, C₄—Solar M8-450
- C₅—Solar M8-500
- C₆, C₇—Solar λLC
- T₁, T₂—U.T.C. S-67
- T₃—U.T.C. PA-301
- T₄—U.T.C. PA-34
- L₁—U.T.C. PA-41
- L₂, L₃—U.T.C. R-14
- L₄—U.T.C. PA-40
- R₁, R₂, R₃—Ohmite Brown Devil
- R₄—Ohmite 0418

Figure 22, page 371

R-F Unit of the 807 Transmitter

- C₁, C₂, C₃, C₄, C₅, C₆, C₇, C₈, C₉, C₁₀, C₁₁, C₁₂—Cornell-Dubilier 1W
- C₁₃, C₁₄—Cornell-Dubilier 5W
- C₁₅—Cornell-Dubilier 4-22020
- R₁, R₂, R₃, R₄, R₅, R₆, R₇, R₈, R₉, R₁₀, R₁₁, R₁₂—Ohmite Little Devil
- R₁₃, R₁₄, R₁₅, R₁₆, R₁₇—Ohmite Brown Devil
- RFC₁—Meissner 19-5840
- RFC₂, RFC₃, RFC₄—National R-100
- S₁—Centralab 1405 or 2505
- J₁—Millen 37001

Figure 24, page 372

Modulator Unit of the 807 Transmitter

- C₁, C₂—Solar M25-25
- C₃, C₄, C₅, C₆, C₇, C₈, C₉—Solar DT
- C₁₀—Solar MW
- C₁₁, C₁₂—Solar XQ
- R₁, R₂, R₃, R₄, R₅, R₆, R₇, R₈, R₉, R₁₀, R₁₁, R₁₂, R₁₃, R₁₄, R₁₅, R₁₆, R₁₇, R₁₈, R₁₉, R₂₀, R₂₁, R₂₂, R₂₃, R₂₄, R₂₅, R₂₆, R₂₇, R₂₈, R₂₉, R₃₀, R₃₁, R₃₂—Ohmite Little Devil
- R₃₃—Mallory N
- R₃₄, R₃₅, R₃₆—Ohmite Brown Devil
- T₁—U.T.C. FT-6
- T₂—Stancor P-4089
- T₃—U.T.C. S-2C
- CH—Peerless C-5093X choke with "I" lamination removed and replaced by wood
- S₁—Centralab 1415
- S₂—Arrow-H&H toggle

CHAPTER 31

Test and Measurement Equipment

Figure 11, page 421

100-Kc. Frequency Spotter

- C₁—Miller 26700
- L₁—Millen 34010
- L₂—Millen 34103
- X—James Knights type H 16

Figure 28, page 430

Audio Oscillator/Test Amplifier

- C₂, C₃, C₄, C₅, C₆, C₇, C₈, C₉, C₁₀, C₁₁, C₁₂, C₁₃, C₁₄, C₁₅—Cornell-Dubilier BR
- C₁₆, C₁₇, C₁₈, C₁₉, C₂₀, C₂₁—Cornell-Dubilier DT
- R₁ through R₁₀—Ohmite Little Devil
- R₁₁—Mallory N
- R₁₂ through R₁₅—Ohmite Little Devil
- R₁₆, R₁₇, R₁₈, R₁₉, R₂₀—Ohmite Brown Devil
- R₂₁—Ohmite Little Devil
- T₁—U.T.C. F₁-6
- T₂—Stancor P-0014
- T₃—Peerless S-39Q
- CH—Stancor C-1710
- S₁—Centralab 1462
- S₂—Centralab 1405 or 2505
- S₃—Arrow-H&H toggle
- R_L—GE S-6 lamps
- Jack shield—National JS-1
- Dial—National ACN
- Panel output terms—National FWH

CHAPTER 32

Conversion of Surplus Equipment

Figure 3, page 433

Power Supply of the BC-312 Receiver

- C₁, C₂—Cornell-Dubilier BR
- T—U.T.C. R-12 may be used
- CH—U.T.C. R-19 may be used
- R₁—Ohmite Brown Devil
- R₂—Ohmite Little Devil
- S—Arrow-H&H toggle
- F—Bussman HKS fuse holder
- Connectors—Jones P-312RP and S-312FHT

Figure 4, page 434

BC-312 Modification

- C₁, C₂, C₃, C₄, C₅—Cornell-Dubilier DT
- C₆, C₇—Cornell-Dubilier BR
- R₁, R₂, R₃, R₄, R₅, R₆, R₇, R₈, R₉, R₁₀, R₁₁, R₁₂—Ohmite Little Devil
- R₁₃—Mallory type 0

THE

SX-42

APPROACHES

Classic

GREATEST CONTINUOUS FREQUENCY

—from 540 kc. to 110

IN THE Model SX-42 Hallicrafters establishes a new high standard of receiver performance and versatility. Covering from 540 kilocycles to 110 megacycles, the SX-42 combines in one superbly engineered unit a top-flight standard and VHF communications receiver; standard, short-wave and FM broadcast receiver, and high fidelity phonograph amplifier.

The tremendous frequency range of the SX-42, greater continuous coverage than has ever before been available in a receiver of this type, is made possible by the development of a new "split-stator" tuning system

and the use of dual intermediate frequency transformers. Reception of amplitude modulated and continuous wave telegraph signals is provided for throughout the entire range of the SX-42. In addition, a discriminator and two limiter stages are available on bands 5 and 6 (27 to 110 megacycles) to permit the reception of frequency modulated signals. Musical reproduction of true high fidelity is assured by an audio system with a response curve essentially flat from 60 to 15,000 cycles and an undistorted output of eight watts.

The controls of the SX-42 are arranged for maximum convenience and simplicity of

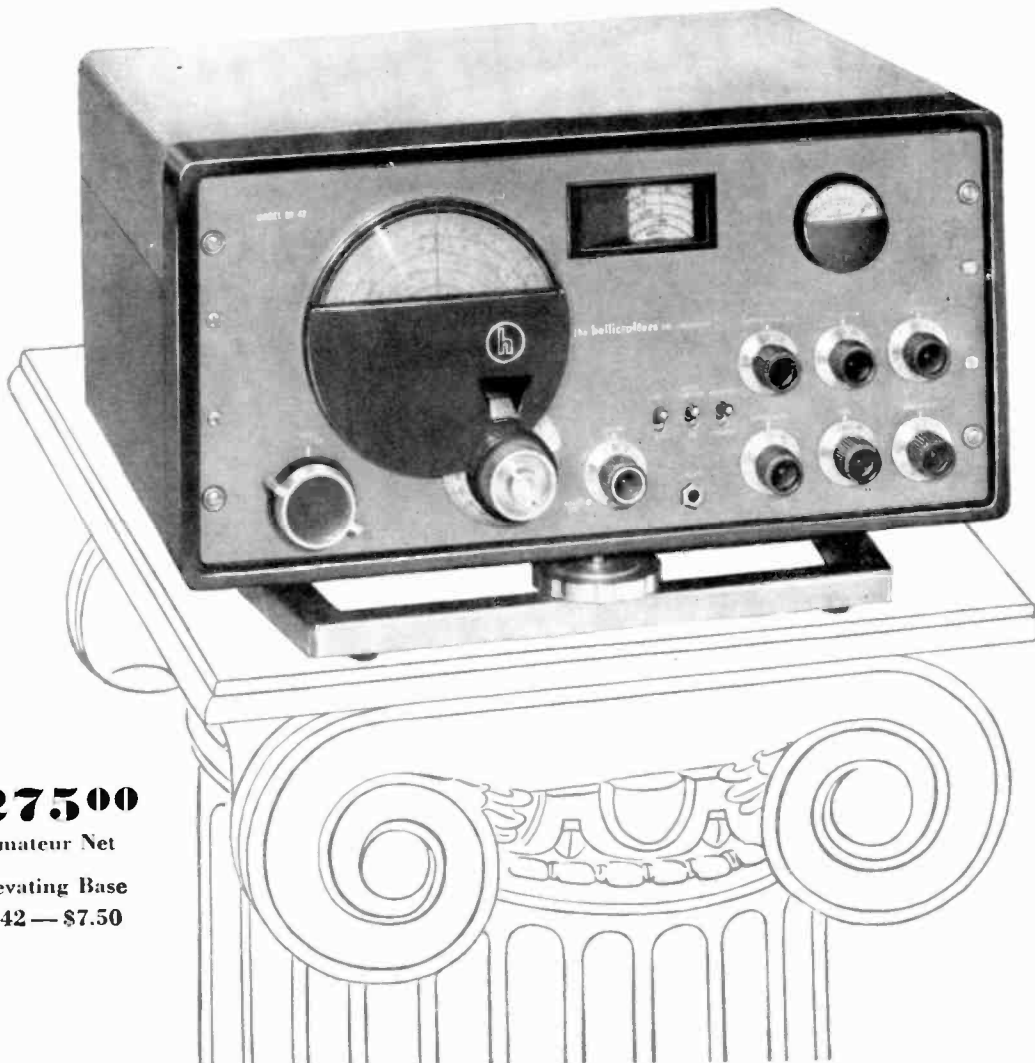

\$275.00

Amateur Net

Elevating Base

B-42 — \$7.50

460

Perfection

COVERAGE

Mc. AM • FM • CW

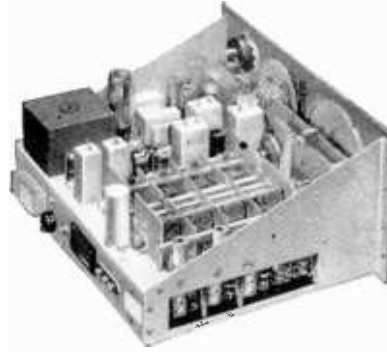

operation. MAIN TUNING and BAND-SPREAD knobs are mounted coaxially, focusing the tuning functions in a single precision-built unit. BAND-SWITCH and VOLUME are located at either side of the main dial. Auxiliary controls such as CRYSTAL PHASING, SENSITIVITY, etc., are logically placed so that those most frequently used are in the most accessible positions. Hallicrafters new system of color coding makes it possible for the entire family to enjoy this fine receiver. The normal control positions for standard broadcast reception are indicated by tiny red dots while FM adjustments are in green.

The main tuning knob is provided with a precision vernier scale which is separately illuminated through a small window in the one-piece Lucite main dial housing. The main tuning dial is calibrated in megacycles and is marked with channel numbers in the new FM band of 88 to 108 megacycles. The bandspread dial is calibrated for the amateur 3.5, 7, 14, 28, and 50 megacycle bands. An additional logging scale is provided on this dial for use in other ranges. The small locking knob mounted coaxially with the main and bandspread tuning knobs permits either to be rotated freely while holding the other firmly in position.

AMATEURS SAY: "Unsurpassed CW performance"

IN ADDITION to its many new features the SX-42 continues all of the time-tried advantages characteristic of Hallicrafters top models. Freedom from drift and maximum stability are provided by temperature compensation and the use of a type VR-150 voltage regulator tube. A crystal filter circuit combined with variable intermediate frequency channel width offers six different degrees of selectivity on the four lower bands (to 30 megacycles). CRYSTAL

PHASING, CW PITCH, SENSITIVITY, and four-position TONE control for LOW, MED, HI FI, and BASS are all conveniently placed on the front panel as are RECEIVE/STANDBY, NOISE LIMITER, and AVC switches.

The beauty and modern functional styling of this new receiver are self evident. Without in any way detracting from the "precision instrument" appearance which characterizes fine communications equipment, Hallicrafters designers have succeeded in creating a receiver which is not out of place in the most luxurious surroundings. The rich deep gray of the panel, satin chrome "aero-dized" top, and light gray lettering with touches of red and green combine with the precision-tooled controls and light translucent green of the illuminated dials and meter in a harmoniously integrated whole.

R-42 SPEAKER

This is the first speaker of its size to offer the splendid advantages of the bass reflex principle. Heretofore the famous Jensen-originated bass reflex reproduction has been available only in large cabinet speakers. Now in this sleek, highly functional design, matching the new line of Hallicrafters receivers, the bass reflex feature is available in a compact speaker that offers a new high quality of reproduction. The R-42 was designed as a companion piece to the SX-42 receiver but it may be used with any other receivers such as the SX-28 and the SX-43. The speaker size is 8 inches. Two-position switch on front panel for communications or high fidelity reception. Terminals on rear for 500-ohm line. R-42 size: 12½ in. deep, 11¾ in. high, 17 in. wide.



R-42 SPEAKER \$20.50

DIMENSIONS: Model SX-42. Cabinet only, 20 inches wide by 9¾ inches high by 16 inches deep. Overall, 20 inches wide by 10¼ inches high by 18 inches deep.

WEIGHT: Model SX-42. Receiver only, approximately 52 pounds. Packed for shipment, approximately 65 pounds. Model B-42, adjustable base, packed for shipment, approximately 5 pounds.

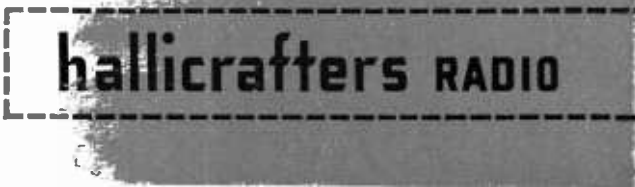



Everything **THE HAM ASKS FOR** in a medium price receiver

OUTSTANDING FEATURE: Wide band FM, AM or narrow band FM on 44-55 megacycles.

CONTROLS: BAND SELECTOR, TUNING, BANDSPREAD, TONE, RECEIVE/STANDBY, NOISE LIMITER, CRYSTAL PHASING, SELECTIVITY, SENSITIVITY, VOLUME AND POWER OFF, RECEPTION, CW PITCH.

EXTERNAL CONNECTIONS: Antenna connections for doublet or single wire. Input impedance matches 300-ohm line except on broadcast band which is designed for single wire antenna. Speaker terminals for 500 or 5000 ohms. Phone jack on front panel. Phonograph input connector on rear of chassis. Socket for use with external power supply. Remote standby control connections in power socket. Power cord, plug.

PHYSICAL CHARACTERISTICS: The cabinet of the Model SX-43 is styled in the new Hallicrafters pattern and is finished in rich satin gray. Panel and chassis may be removed as a unit for servicing without disturbing any con-

trols. "Airodized" steel top swings open on full length piano hinge for maximum accessibility. Panel lettering is in light gray with incidental red and green markings for standard and FM broadcast reception. Dials are indirectly illuminated and are a light translucent green.

TUBES: 1—6BA6 RF amplifier; 1—7F8 converter-oscillator; 1—6SG7 1st IF amplifier; 1—6SH7 2nd IF amplifier and second converter, band 5 AM; 1—6SH7 3rd IF amplifier (10.7 Mc.); 1—6H6 AM detector and noise limiter; 1—6AL5 FM detector; 1—6SQ7 1st AF amplifier; 1—6J5 beat frequency oscillator or second converter oscillator, band 5; 1—6V6 audio output tube; 1—5Y3 rectifier.

OPERATING DATA: The standard Model SX-43 is designed for operating on 105-125 volts, 50/60 cycle alternating current. The universal Model SX-43U may be operated on 110, 130, 150, 220, or 250 volts, 25 to 60 cycles, alternating current. The standard model draws 90 watts at 117 volts. When operated from external batteries the heaters require 3.8 amperes at 6 volts and the plate circuit draws 105 milliamperes at 270 volts.

DIMENSIONS: Model SX-43. Cabinet only, 18½ inches wide by 8½ inches high by 12 inches deep. Overall 18½ inches wide by 8¾ inches high by 13 inches deep.

WEIGHT: Model SX-43. Receiver only, approximately 35 pounds. Packed for shipment, approximately 45 pounds.

R-44 SPEAKER

Offers for the first time in a professional style cabinet, the advantages of an oval speaker.

The large oval size plus ample baffling give excellent low frequency response. The cabinet proportions and finish provide a perfect match with any communications receivers. Especially designed as a companion unit to the SX-43, but it may also be used with the SX-25, SX-28, and SX-42. The speaker size is 6 x 9 inches. Two-position switch on front panel for communications on high fidelity reception. Terminals on rear for 500 ohm line. R-44 size: 18½ in. wide

by 8½ in. high by 9¾ in. deep \$19.50

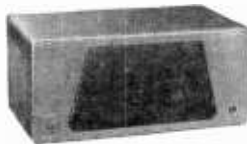

B & W AIR INDUCTORS

AND
VARIABLE AIR CONDENSERS

STOP TANK CIRCUIT LEAKS

... with this complete B & W Coil
and Capacitor assembly

B & W Type CX Variable Capacitors provide for direct mounting of B & W Air Inductors. Wiring is eliminated. Circuit lead lengths are reduced to an absolute minimum. Opposed stator sections in the capacitors provide short r-f path. Butterfly rotor construction permits grounding rotor at the center r-f voltage point with respect to stators. Built-in neutralizing capacitors can be mounted on end plate. Standard types rated at 500, 750 and 1,000 watts. Treat your new rig to real tank circuit efficiency! Write for catalog.

Neutralizing Plates Available in 4 Types

B & W B, T AND HD INDUCTORS

100-WATT, 500-WATT AND 1 KW TYPES

- MINIMUM DIELECTRIC IN THE FIELD OF THE COIL
- EXTREMELY LOW LOSSES—RUGGED CONSTRUCTION
- EXCELLENT APPEARANCE—LOW COST

Type "B" inductor is for use on oscillator and buffer-doubler stages developing up to 100 watts. Available in center tapped models without link; end link; center link, center tapped; and variable link—center tapped. For 5, 10, 15, 20, 40 and 80 meter bands.

Type "T" is specially suited for high powered neutralized buffer and final tank stages where powers of 500 watts are developed. Available in center tapped models without link; center linked with center tap and variable linked with center tap. Made for 10, 15, 20, 40 and 80 meter bands.

Type "HD" is for maximum power and handles a kilowatt with ease. Available in center tapped models without link; center linked with center tap and variable linked with center tap. Made for 10, 15, 20, 40 and 80 meter bands.

B & W TVH INDUCTORS

for powers up to 500-watts input

Here is a special group of units designed for greater flexibility through use of an eight plug jack bar. With these inductors it is possible to connect automatically, a fixed padding capacitor when using the low frequency coil. Available for 10, 15, 30, 40 and 80 meter bands.

SEE B & W PRODUCTS AT YOUR JOBBER'S

Write for Complete Amateur Catalog

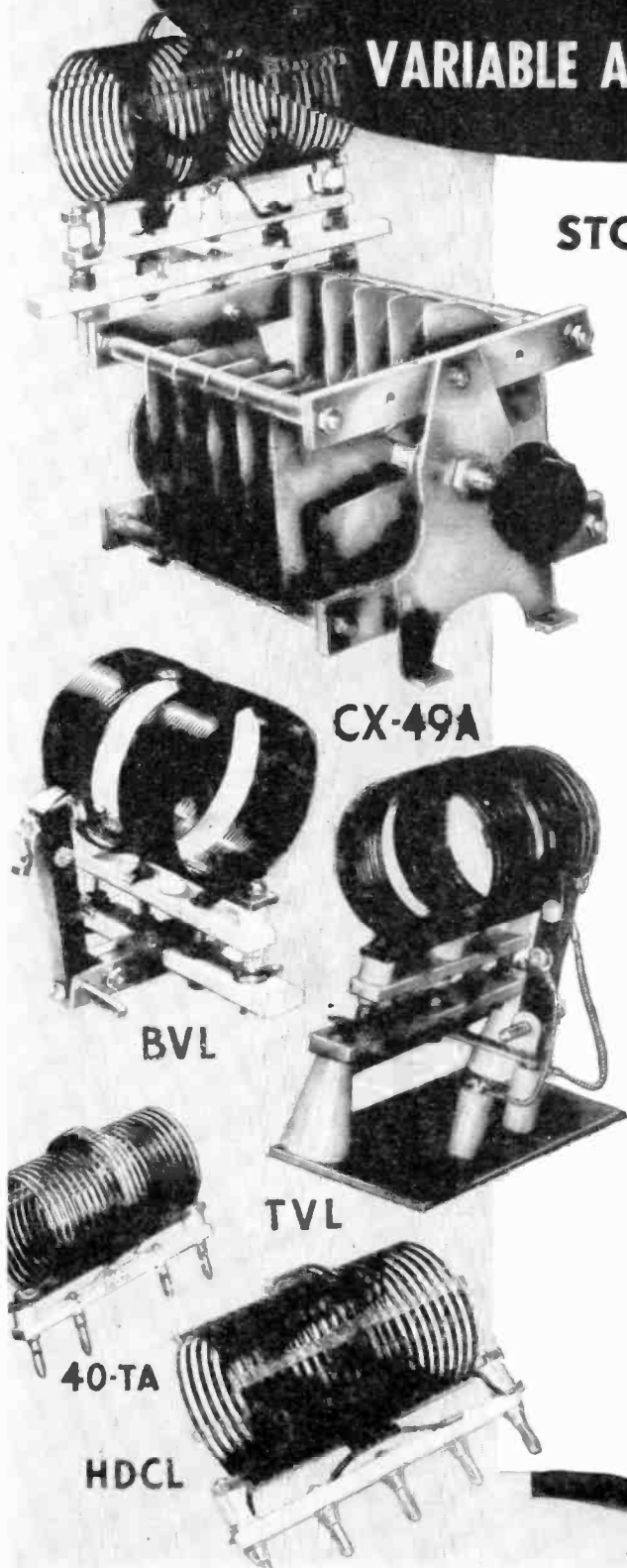

2A "BAND HOPPERS"



B & W TURRET ASSEMBLIES

Fast, positive band switching for your rig! Moderate in cost — easy to install — adaptable to 30, 40, 20, 15 and 10 meter bands. These turrets eliminate absorption effects through use of a unique switching assembly which shorts unused coils.

B & W — 75-Watt 2A "BAND HOPPERS" — A compact and panel controlled unit which may be used for interstage coupling between two beam power tubes or between beam power tubes and triodes.

B & W 75-WATT TURRETS — for link coupling single ended or push-pull low power stages. Mounted on a positive action switch arranged for panel mounting through a single $\frac{3}{8}$ " hole.

Type JTCL — Center linked, center tapped coils.

Type JTEL — End linked, untapped coils.

B & W 150-WATT TURRETS — for single- and double-ended circuits. These mount the same as 75-watt turrets and are used with tubes operating at voltages up to 1000 volts.

Type BCL — Center linked, center tapped coils.

Type BEL — End linked, untapped coils.

B & W BABY TURRETS — 35-WATTS

Rated at 35 watts, these compact, 5-band switching units cover amateur bands from 10 to 80 meters. They are suitable for all services with any of the 50 mufd. midget condensers. Sturdy construction and unusual design assures permanent coil alignment and maximum efficiency with the minimum number of tubes. Available in four types: BTM — straight untapped; BTCT — center tapped; BTET — end linked; and BTCL — center linked. All provide vastly improved band switching efficiency in low power transmitters and exciter stages.

ANTENNA INDUCTORS TA AND HDA

These coils are wound with tinned copper wire for ease in tapping feeders and have fixed center links for coupling to either fixed or variable linked final tank circuits through low impedance line. Available for 10, 15, 20, 40 and 80 meter bands. Type TA for power input up to 500 watts and Type HDA for power inputs of one kilowatt.

B & W 3400 SERIES INDUCTORS

Presenting the utmost in sturdy construction and electrical flexibility, these coils are built with an individual internal center coupling, adjustable over 360° — permitting precise impedance matching up to 600 ohms. For powers up to 500 watts. Available for 10, 15, 20, 40 and 80 meter bands.

THE MIDGET R-F COILS of dozens of uses

Goodbye to homemade high-frequency coils! B & W Midget coils cost little, are beautifully constructed — and do the job right. Every day, amateurs, experimenters and equipment manufacturers tell us of new applications where Midget coils have replaced homemade coils with a big boost of efficiency. Use them for receivers, transmitters and test equipment — in tank circuits as r-f chokes, high-frequency i-f transformers and loading coils and for dozens of other purposes.

B & W "Air Wound" construction permits small but sturdy supports with the absolute minimum of insulating material in the electrical field. Q factor is amazingly high. Standard Midget coil diameters are $\frac{1}{2}$ ", $\frac{3}{8}$ ", $\frac{3}{4}$ " and 1", each available in four different winding pitches. Ask your jobber. He can supply these coils, individually packaged, in standard 2" or 3" lengths.

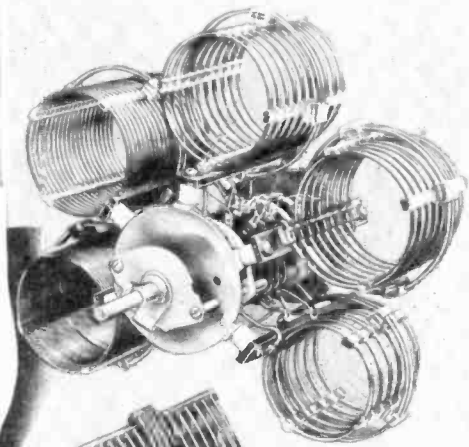

BCL

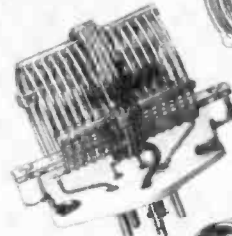

JCL

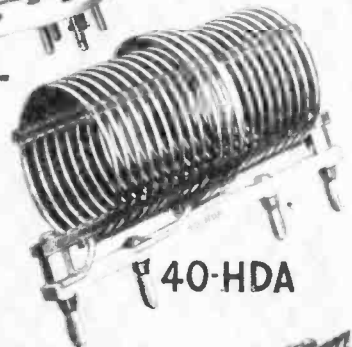

40-HDA

3400

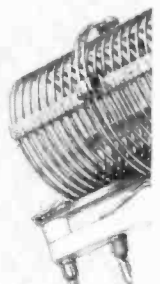
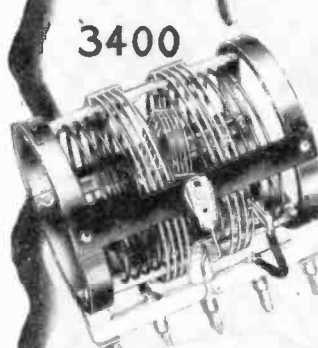

TCL

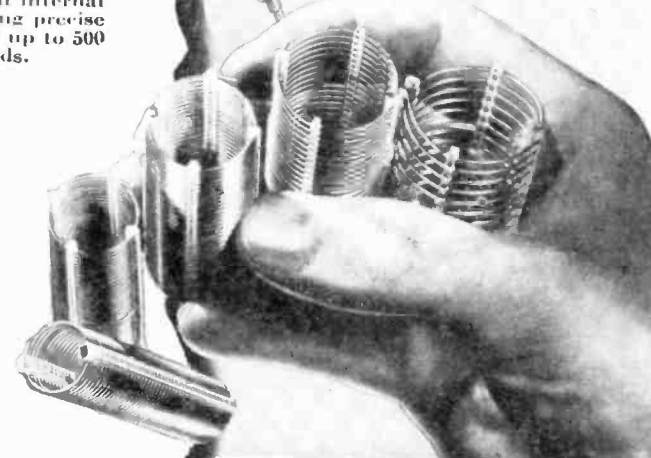

NEW! B & W TEST EQUIPMENT ON FOLLOWING PAGE
BARKER & WILLIAMSON, Inc.

6 New B & W Products

1—MIDGET "BUTTERFLY" CAPACITORS

With only 25% frontal area of the heavier CX Variable Capacitors, these new B&W JCX units are ideal for general uses — especially for medium-powered triode or tetrode stage plate circuits. Coils can be mounted directly on the capacitors.

2—VFO EXCITER

Stability of the highest order.

This new Model 500 B&W VFO Exciter is both a low-powered transmitter and a deluxe exciter for the amateur who demands an exceptionally high degree of mechanical and thermal stability. The ideal Exciter for those who want ultimate VFO control at moderate cost.

The Model 502 VFO complete with dial assembly and full instructions may be obtained separately.

3—AUDIO OSCILLATOR

For any application where an extremely stable, accurately calibrated source of frequencies between 30 and 30,000 cycles is required.

Small size, light weight, ease of operation and outstanding performance make this B&W Model 200 Audio Oscillator unsurpassed for distortion or frequency measurements.

4—AUDIO FREQUENCY METER

For direct measurement of audio frequencies up to 30,000 cycles.

A compact, light weight, highly efficient instrument for routine checking of audio oscillators and tone generators or for direct measurements of unknown audio frequencies. Six ranges cover from 0-100; 300; 1,000; 3,000; 10,000 and 30,000 cycles.

5—DISTORTION METER

An ideal meter for frequency analysis.

Designed for measuring low-level audio voltages and determining their noise and harmonic content, the B&W Model 400 Distortion Meter is a highly satisfactory instrument for either field or laboratory use. It is also well suited for measuring frequency and gain characteristics of audio amplifiers where a vacuum tube voltmeter is required in the audio range.

6—SINE WAVE CLIPPER

The B&W Model 250 Sine Wave Clipper is a device for generating a test signal that is particularly useful for examining the performance characteristics of audio frequency circuits. Small size, $5\frac{3}{8}'' \times 3\frac{3}{4}'' \times 2\frac{1}{8}''$. Light weight coupled with low price make this entirely new instrument of great value to the discriminating amateur or technician who wishes peak performance in audio equipment.

B & W COILS — Including Famous "Air Wound" types
FOR ALMOST EVERY ELECTRONIC APPLICATION

See Previous Pages



COAXIAL CONNECTOR "CC-50"

For Efficient, Watertight Coaxial
Cable Connections



FEATURED BY LEADING DISTRIBUTORS. DATA
BULLETIN COVERING ALL TYPES ON REQUEST

BARKER & WILLIAMSON, Inc.

237 FAIRFIELD AVENUE, UPPER DARBY, PA.

EXPORT: ROYAL NATIONAL CO., INC. • 75 WEST ST., NEW YORK, N. Y.

PREMIUM QUALITY

at no extra cost



PAPER, MICA AND
FP CAPACITORS



TRANSMITTING
CAPACITORS

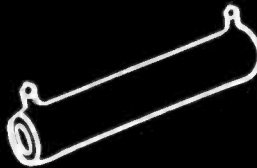

FIXED AND ADJUSTABLE
RESISTORS

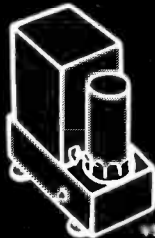

VIBRATORS AND
VIBRAPACKS*



POTENTIOMETERS
AND RHEOSTATS



"HAMBAND" SWITCHES



NOISE FILTERS

When you go to the time and expense of building a new rig, it doesn't pay to take chances on unknown components. Protect your work with **APPROVED PRECISION PARTS**: make it Mallory and make sure.

Mallory was first to introduce many components to the radio

*Reg. U. S. Pat. Off.

field—first, too, to standardize and simplify their manufacture. The very name Mallory means **PREMIUM QUALITY**. It's a guarantee of performance for which you pay no more.

Expect more from Mallory: you're certain to get it. See your Mallory Distributor.

P. R. MALLORY & CO., Inc., INDIANAPOLIS 6, INDIANA

ROTOMATIC BEAM

LATEST ADDITION TO FAMOUS JOHNSON LINE

The solution to QRM on the crowded DX bands is the new JOHNSON Rotomatic Antenna Array. It's strong, light, has broad band characteristics, and provides tremendous increase in signal strength. Two band operation is possible with the Deluxe model. Two 3-element arrays can be matched and fed with the same efficient open wire transmission line. On ten, as many as four elements can be used.

The drive unit is really **heavy-duty** — providing rotation through 360° at 1½ RPM. May be purchased without motor for hand drive. The combined direction indicator, with great circle map and beam control is a marvel of operating efficiency — where speed counts as never before.

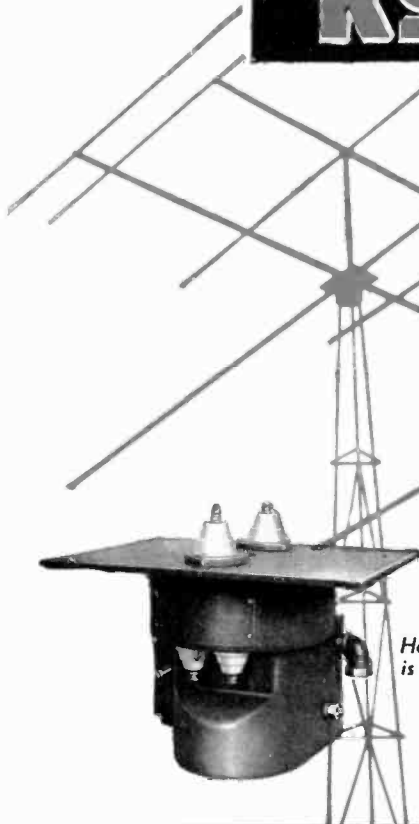

Heavy-duty drive unit is self-lubricating and fully enclosed.



New direction indicator and beam control is Selsyn motor operated.

INSULATORS

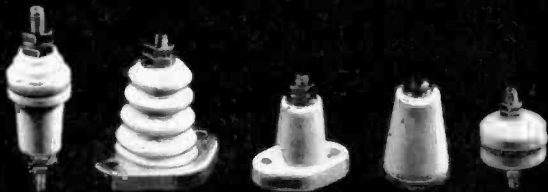

JOHNSON Insulators are specifically designed to handle high RF with low loss. They possess, in addition, logical proportions, clean-cut accurate molding, and high grade nickel plated brass hardware with milled — not stamped — nuts. The Johnson line includes stand-off, cone, thru-panel, antenna, feeder and strain insulators.

SPEED X TRANSMITTING KEYS

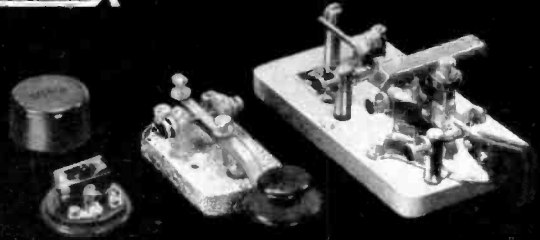

The Speed X line, long a leader in its field, is now manufactured by JOHNSON. It includes everything from buzzers to high speed semi-automatic keys. Pictured are the hand key, Model 326, and beautiful chrome finish, new and improved Model 501 semi-automatic. Model 501, Amateur Model 515 and Junior 510 also available in left hand models.

PILOT LIGHTS



To round out its line, JOHNSON recently purchased the entire Gothard line of fine pilot lights. The Gothard line is a complete line and will be maintained to provide a wide choice and permit selection of a light which will more exactly meet your needs. All metal parts are brass with the exception of hex nuts. Parts are heavily plated and jewel holders are polished chrome or nickel.

TUBE SOCKETS



JOHNSON Tube Sockets have consistently led the way to better design for better results. Present day demands for ever better radio-electronic circuits and equipment are more than adequately met with JOHNSON Tube Sockets. Superior in mechanical and electrical design, JOHNSON Tube Sockets are available in both standard and "special" sizes.



NEW CABINETS, RADIO PANELS AND CHASSIS

The skill of JOHNSON in building cabinets for its Phasing and Antenna Coupling Equipment is now directed to mass production of cabinets, racks, panels and chassis. They are professional in appearance, characteristically reasonable in price. A unique feature is the ventilation system which permits units to be placed flush side-by-side. Chassis have a new type flush joint which eliminates sharp and protruding edges.

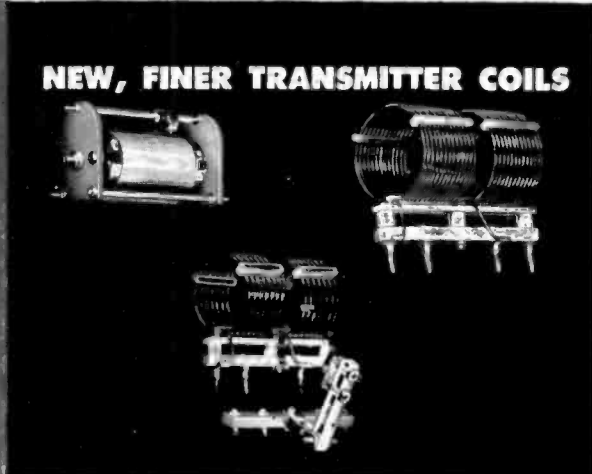

NEW, FINER TRANSMITTER COILS

JOHNSON is the first to offer the amateur a complete line of transmitting inductors with commercial efficiency. New plug-in link pick-up coils make possible efficient impedance matching to the transmission line. Correct LC ratio with either high or low voltage tubes, can be secured by the purchase of only one additional coil in the series for operation from 6 to 80 meters. Also pictured is the JOHNSON Rotary Inductor.

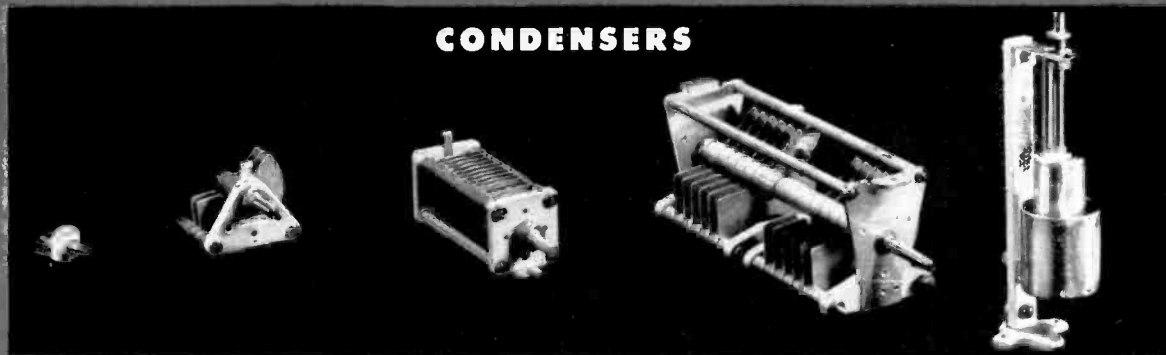

CONDENSERS

Dependable performance is the yardstick by which quality of condensers is measured. Every JOHNSON condenser is precision engineered not only for superlative performance but for durability as well. The exacting requirements of amateur, commercial broadcast and industrial operation are rigidly met for your

complete satisfaction. What's more, JOHNSON makes a condenser for every stage of the amateur transmitter from oscillator through the final amplifier. Whatever your requirements, the choice of JOHNSON condensers is complete.



PLUGS, JACKS AND HARDWARE

Constant attention to detail plus pride in manufacture make JOHNSON hardware a perfect compliment to your "cream station". The quality is there, yet the price is modest. Included in the JOHNSON Hard-

ware line are couplings, tube caps, plugs and jacks, inductor clips, soldering terminals, tube locking clamps, panel bearings, flexible shafts, fuse clips, handle indicators and cable connectors.



JOHNSON products can be obtained from radio-electronic parts jobbers, or write directly for further information. You'll be glad you did!

SEND FOR LATEST JOHNSON CATALOG

JOHNSON . . . a famous name in Radio

E. F. JOHNSON CO. WASECA, MINNESOTA

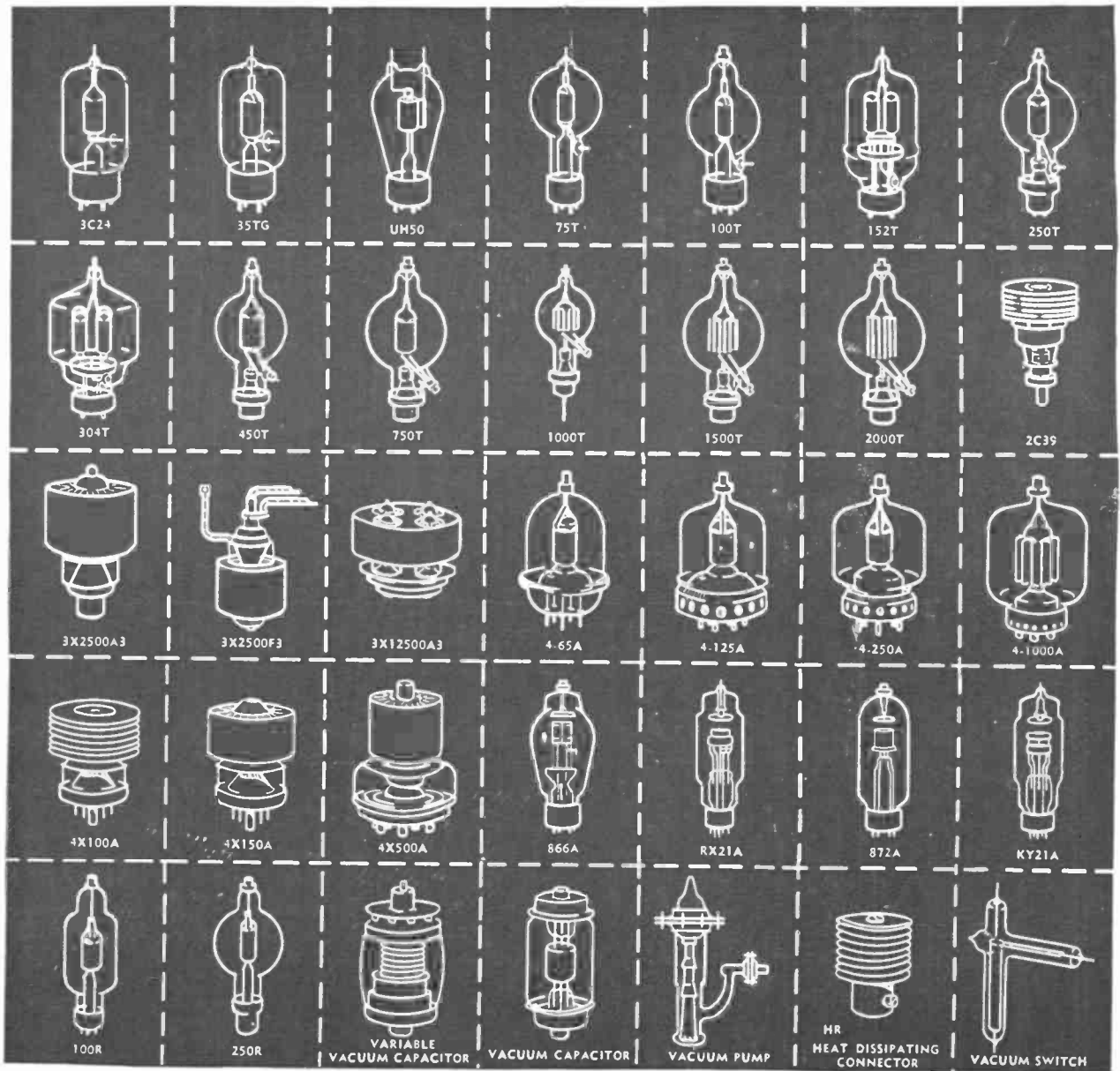

Listed on these pages are Eimac tubes, "proven in service" for more than a decade in the most outstanding electronic equipment in operation. When you invest in a product trade marked "Eimac" you are assured of the utmost in performance and dependability . . . backed by the reputation of America's foremost manufacturer of high-frequency transmitting tubes.

Further data and application notes are available, write direct, or see your dealer.

EITEL-McCULLOUGH, INC., 184 San Mateo Avenue, San Bruno, California

Eimac
REG. U. S. PAT. OFF.
TUBES

EIMAC TUBES

EIMAC TUBE TYPES	ELECTRICAL							MECHANICAL				MAX. RATINGS					TUBE PRICE	RECOMMENDED HR HEAT DISSIPATING CONNECTORS			
	FIL. VOLTS	FIL. AMPS.	AMP. FACTOR	GRID-PLATE, UUF	INPUT UUF	OUTPUT UUF	TRANSCONDUCTANCE UMHOS	BASE	BASING	MAX. LENGTH, INCHES	MAX. DIAMETER INCHES	PL. VOLTAGE	PL. CURRENT, MA.	SCREEN VOLTAGE	SCREEN DISSIPATION WATTS	GRID DISSIPATION WATTS		PL. DISSIPATION WATTS	PLATE	GRID	
TRIODES	25T	6.3	3.0	29	1.6	2.4	0.4	2500	M8-071	3G	4.38	1.43	2000	75	...	7	25	6.00	HR-1	...	
	3C24	6.3	3.0	25	1.6	1.8	0.2	2500	M8-071	3G	4.38	1.43	2000	75	...	8	25	6.00	HR-1	HR-1	
	35T	5.0	4.0	30	1.9	4.0	0.2	2850	M8-078	3G	5.5	1.81	2000	150	...	15	50	7.00	HR-3	...	
	35TG	5.0	4.0	30	1.9	1.9	0.2	2850	M8-078	2M	5.75	1.81	2000	150	...	15	50	8.00	HR-3	HR-3	
	UH50	7.5	3.25	13	2.4	2.2	0.4	...	M8-078	2M	7.0	2.69	1250	125	...	13	50	15.00	HR-2	HR-2	
	75TH	5.0	6.5	20	2.3	3.5	0.25	4150	M8-078	2M	7.25	2.81	3000	225	...	16	75	10.50	HR-3	HR-2	
	75TL	5.0	6.5	11	2.3	2.2	0.4	3350	M8-078	2M	7.25	2.81	3000	225	...	13	75	10.50	HR-3	HR-2	
	2C39*	6.3	1.1	..	1.95	6.5	0.30	21,000	2.75	1.26	1000	1001	...	3	100	30.00	
	100TH	5.0	6.2	40	2.0	2.9	0.4	5500	M8-078	2M	7.75	3.19	3000	225	...	20	100	15.00	HR-6	HR-2	
	100TL	5.0	6.5	12	2.3	2.0	0.4	2300	M8-078	2M	7.75	3.19	3000	225	...	15	100	15.00	HR-6	HR-2	
	152TH	5 or 10	13 or 6.5	20	4.7	7.0	0.5	8300	5000B	4BC	7.63	2.56	3000	450	...	30	150	24.00	HR-5	HR-6	
	152TL	5 or 10	13 or 6.5	11	5.0	4.8	0.8	7150	5000B	4BC	7.63	2.56	3000	500	...	25	150	24.00	HR-5	HR-6	
	3C37*	6.3	2.4	..	3.50	4.25	0.60	8000	3.10	1.50	1000	150	45.00	
	250TH	5.0	10.5	37	2.9	5.0	0.7	6650	5001B	2N	10.13	3.81	4000	350	...	40	250	27.50	HR-6	HR-3	
	250TL	5.0	10.5	13	3.5	3.0	0.5	2650	5001R	2N	10.13	3.81	4000	350	...	35	250	27.50	HR-6	HR-3	
	304TH	5 or 10	26 or 13	20	9.4	14.0	1.0	16,700	5000B	4BC	7.63	3.56	3000	900	...	60	300	50.00	HR-7	HR-6	
	304TL	5 or 10	26 or 13	11	10.0	10.0	1.5	16,700	5000B	4BC	7.63	3.56	3000	1000	...	50	300	50.00	HR-7	HR-6	
	450TH	7.5	12.0	38	4.7	8.1	0.8	6650	5002B	4AQ	12.63	5.13	6000	500	...	80	450	70.00	HR-8	HR-8	
	450TL	7.5	12.0	19	5.0	6.6	0.9	6060	5002B	4AQ	12.63	5.13	6000	500	...	65	450	70.00	HR-8	HR-8	
	750TL	7.5	21.0	15	4.5	6.0	0.8	3500	5003B	4BD	17.0	7.13	6000	1000	...	100	750	150.00	HR-9	HR-8	
1000T	7.5	16.0	30	4.0	6.0	0.6	9050	5004B	4AQ	12.63	5.13	6000	750	...	80	1000	125.00	HR-9	HR-9		
1500T	7.5	26.0	24	7.0	9.0	1.3	10,000	5005B	4BD	17.0	7.13	6000	1250	...	125	1500	200.00	HR-8	HR-9		
2000T	10.0	26.0	20	9.0	13.0	1.5	11,000	5006B	4BD	17.75	8.13	6000	1750	...	150	2000	250.00	HR-8	HR-9		
3X2500A3*	7.5	48	20	20	48	1.2	20,000	9.0	4.25	5000	2000	...	125	2500	165.00		
3X2500F3*	7.5	48	20	20	48	1.2	20,000	9.0	4.25	5000	2000	...	125	2500	165.00		
3X12500A3*	7.5	192	20	95	240	5.0	80,000	9.5	4.1	5000	800	...	600	12,500	700.00		
TETRODES	4-65 A	6.3	3.5	5	0.8	8	2.1	4000	4.25	2.31	3000	150	400	10	5	65	14.50	HR-6	...
	4X100A*	6.3	2.8	4.5	0.2	14.1	4.7	12,000	2.56	1.62	1000	250	300	15	4	100	28.00	HR-6	...
	4-125A	5.0	6.2	6.2	0.03	10.3	3.0	2450	5008B	...	5.69	2.72	3000	225	400	30	5	125	25.00	HR-6	...
	4X150A*	6.3	2.8	4.5	0.2	14.1	4.7	12,000	2.5	1.75	1000	250	300	15	4	150	31.00	HR-6	...
	4-250A	5.0	14.5	..	0.06	12.7	4.5	3000	5008B	...	6.38	3.56	4000	350	600	50	5	250	36.00	HR-6	...
	4X500A*	5.0	12.2	..	0.05	11.1	3.75	5200	4.32	2.57	4000	300	450	30	5	500	85.00	HR-6	...
4-1000A	7.5	21	7.2	24	27.2	7.6	10,000	9.75	5	6000	700	1000	75	25	1000	108.00	HR-8	...	

*Special Anodes requiring filament arcing
*Anode Current

EIMAC RECTIFIERS

A-A-4 Johnson No. 122-247 or 122-101

	MERCURY VAPOR RECTIFIERS				HIGH VACUUM RECTIFIERS			
	866A (866)	RX21A (RX-21)	872A (872)	KY21A KY-21 Grid Control	100-R	2-150A (152-R)	2-150D (152-RA)	250-R
1. Filament Voltage	2.5	2.5	5.0	2.5	5.0	5.0	5.0	5.0
2. Filament Current	5.0 amperes	10 amperes	7.5 amperes	10 amperes	6.5	13.0	13.0	10.5
3. Peak Inverse Voltage	10,000	11,000	10,000	11,000	40,000	30,000	30,000	60,000
4. Peak Plate Current	1.0 amperes	3 amperes	5.0 amperes	3 amperes	100 amperes	150 amperes	150 amperes	250 amperes
5. Average Plate Current	25 amperes	75 amperes	1.25 amperes	75 amperes	100 amperes	150 amperes	150 amperes	250 amperes
Price	\$1.75	\$8.00	\$7.50	\$10.00	\$13.50	\$15.00	\$15.00	\$20.00

EIMAC VACUUM CAPACITORS

Type	VC6-20	VC12-20	VC25-20	VC50-20	VC6-32	VC12-32	VC25-32	VC50-32
Capacity	6-mmfd	12-mmfd	25-mmfd	50-mmfd	6-mmfd	12-mmfd	25-mmfd	50-mmfd
Rating RF Peak	20-KV	20-KV	20-KV	20-KV	32-KV	32-KV	32-KV	32-KV
Price	\$12.00	\$13.50	\$16.50	\$20.00	\$14.00	\$16.00	\$19.00	\$22.50

HEAT DISSIPATING CONNECTORS

Type	Hole Dia.	Price	HR-5	.125	\$.80
HR-1	.052	\$.60	HR-6	.360	.80
HR-2	.0625	.60	HR-7	.125	1.60
HR-3	.070	.60	HR-8	.570	1.60
HR-4	.1015	.80	HR-9	.570	3.00

EIMAC DIFFUSION PUMP

HV-1 Diffusion Pump	PRICE ON APPLICATION
An air-cooled vacuum pump of the oil-diffusion type. Capable of reaching an ultimate vacuum of 4×10^{-7} mm. of mercury when used with a suitable mechanical forepump. Speed without back approximately 67 liters/second at 4×10^{-4} to 4×10^{-5} mm.	
Eimac Pump Oil	

EIMAC VACUUM SWITCHES

TYPE	GENERAL DATA	PRICE
VS-2...	Single pole double throw switch within a high vacuum adaptable for high voltage switching. Contact spacing .015". Switch will handle R-F potentials as high as 20 Kv. In DC switching will handle approximately 1.5 Amps at 5 Kv.	\$12.00
VS-1...	Same as above except for slightly smaller glass tubulation.	\$12.00

Unmatched in performance!

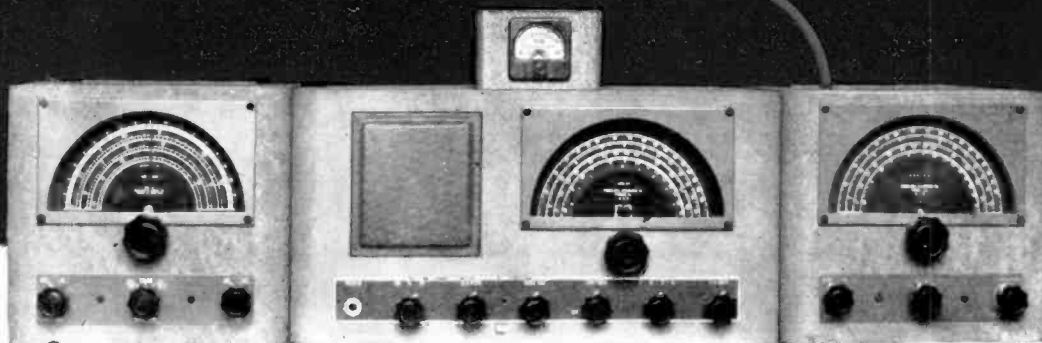

VHF 152A
TYPE S

RME 84

DB 22A
TYPE S

THE VERSATILE RME 84

The RME 84 is versatile because it can be used for home, portable or mobile operation. It operates off 110 AC or a 6 volt power pack with cable attached. Optional equipment for the RME 84 is the RME VP2 — power pack and the carrier level "S" meter, CM-1, both with cord and plug.

It's an all band coverage receiver for phone or CW — RME's first entry into the lower priced communications field, and built to RME's rigid specifications of quality components and quality workmanship. Other features include:

- Excellent over-all sensitivity
- All gear and planetary tuning mechanism
- New "loctal" tubes
- Four tuning ranges: .54 to 44 MC
- One preselector stage
- Automatic noise limiter
- Self contained shock mounted PM speaker
- Seven tube superheterodyne circuit, excluding rectifier.

THE VHF 152

Utilizing the extremely effective double conversion system, the VHF 152 Converter provides peak performance on 2, 6, 10 and 11 meters when used with any communications receiver. Wide bandspread on each band is obtained through 180 degree travel over a 7" diameter scale with accurate calibration.

ANTENNA CONNECTIONS

Provision is made for the use of four separate antenna connections. Thus each band has its own especially designed antenna input circuit. Other features include an individual power supply, shielded output cable, calibrated dial, all-gear planetary tuning mechanism, voltage regulator, VHF oscillator circuits that are temperature stabilized and new high gain miniature tubes.

Illustrated Folder Available For Each RME Product



RME

FINE COMMUNICATIONS EQUIPMENT

RADIO MFG. ENGINEERS, INC.

Peoria 6, Illinois U. S. A.

matched in appearance...

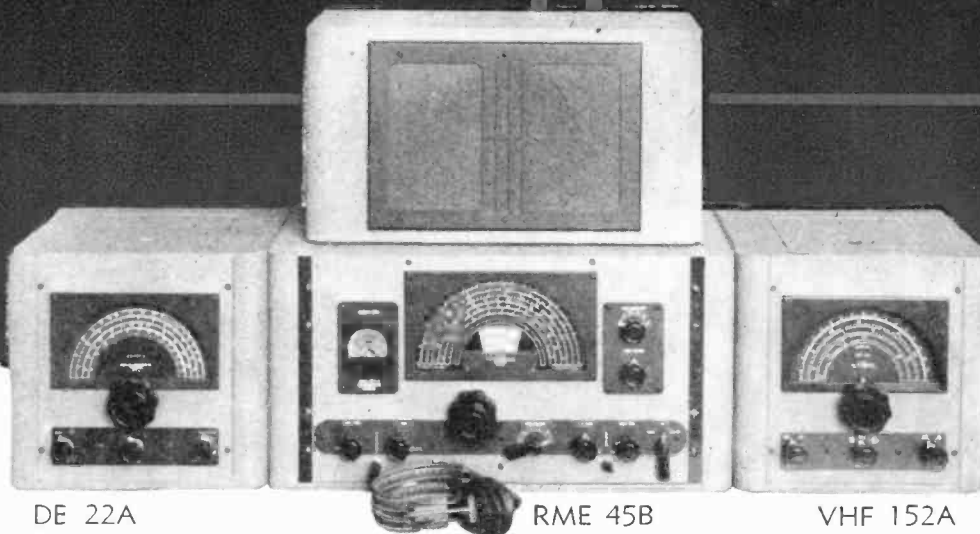

DE 22A
STANDARD

RME 45B

VHF 152A
STANDARD

THE RME 45 RECEIVER

The RME 45 communications receiver provides peak performance on both the high and low frequencies. It's accomplished by the use of loctal tubes—shorter leads—reduced distributed capacity and temperature compensating padders.

Especially desirable are two additional refinements—Cal-O-Matic two speed tuning and calibrated bandspread. Two speed tuning tunes fast to cover the band, tunes slowly to find the station. It provides the maximum in mechanical and electrical efficiency. Other features include:

- Streamlined two-toned cabinet that matches the Standard DB 22 A and VHF 152 A in size and appearance
- Six Bands, 550 to 33,000 KC
- Automatic Noise Limiter
- Variable Crystal Filter
- Signal Level Meter

DB 22 A PRESELECTOR

The new DB 22 A has been completely redesigned for greater efficiency and higher signal to noise ratio. It uses two of the new efficient 6BA6 miniature tubes. The DB 22 A provides tremendous increase in both gain and selectivity when used with a good communications receiver. Average overall gain is 30 DB achieved throughout the tuning range of .54 to 44 MC. Image rejection is phenomenal—better than 50 DB with a communications receiver having a single stage of RF. The DB 22 A has its own power supply—is entirely self contained—entirely in a class by itself! This preselector also comes in two models to match in size and appearance either the RME 45 or the RME 84 receivers. The larger cabinet of the DB 22 A matches the RME 45, the DB 22 A "Type S" matches the smaller RME 84. The price is the same. Both are identical except for cabinet size.

Just Announced

THE HF 10-20 CONVERTER FOR 10-11-15 and 20 METERS

Because of the double conversion system, the HF 10-20 provides outstanding and imageless reception on the above frequencies. And it's an especially vital adjunct to those receivers that tune only to 48 MC. Features include provision for four separate antennas, self contained power supply, variable tuning mechanism and many others.

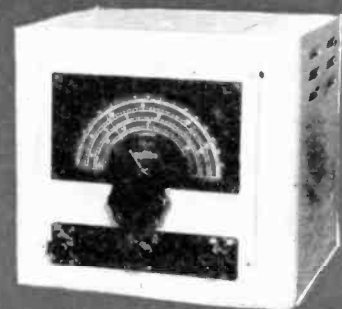



Be Right with **OHMITE**



BROWN DEVIL RESISTORS

Small, extra sturdy, wire wound, vitreous enameled resistors for voltage dropping, bias units, bleeders, etc. Proved right in vital installations the world over. In 5, 10 and 20-watt sizes in values to 100,000 ohms.



DUMMY ANTENNA RESISTORS

To check r.f. power, determine transmission line losses, check line to antenna impedance match. Helps tune up to peak efficiency. Noninductive, non-capacitive, constant in resistance. 100 and 250-watt, in various resistances.

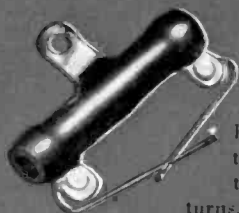

CENTER TAPPED RESISTORS

For use across tube filaments to provide an electrical center for the grid and plate returns. Center tap accurate to plus or minus 1%. Wirewatt (1 watt) and Brown Devil (10 watt) units, in resistances from 10 to 200 ohms.

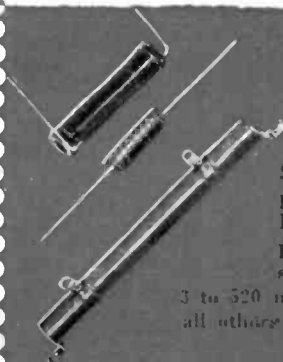

NEW HIGH FREQUENCY CHOKES

Single layer wound on large power factor steatite or bakelite core, with moisture-proof coating. Seven stock sizes for all frequencies from 3 to 520 mc. Two units rated 600 ma, all others are rated 1000 ma.

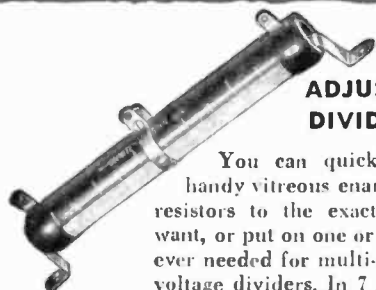

ADJUSTABLE DIVIDOHMS

You can quickly adjust these handy vitreous enameled Dividohm resistors to the exact resistance you want, or put on one or more taps wherever needed for multi-tap-resistors and voltage dividers. In 7 sizes from 10 to 200 watts. Resistances to 100,000 ohms.



PARASITIC SUPPRESSOR

Small, light, compact noninductive resistor and choke in parallel, designed to prevent u.h.f. parasitic oscillations which occur in the plate and grid leads of push-pull and parallel tube circuits. Only 1 3/4" long over-all and 3/8" in diameter.



FIXED RESISTORS

Resistance wire is wound over a ceramic core, permanently locked in place, insulated and protected by Ohmite vitreous enamel. Terminated by leads. 25, 50, 100, 160 and 200-watt stock sizes, in resistances from 1 to 250,000 ohms.



R. F. POWER LINE CHOKES

Keep r.f. currents from going out over the power line and causing interference with radio receivers. Also use at factories to suppress r.f. interference. Wound on a ceramic core and has a moisture-proof coating. Three stock sizes, rated 2, 10, and 20 amps.

RHEOSTATS...RESISTORS...CHOKES...

POTENTIOMETERS...SWITCHES

*Accurate * Dependable * Long-lived*



CLOSE-CONTROL RHEOSTATS

Insure permanently smooth, close control in communication, electronic and electrical devices. Widely used in industry. All ceramic, vitreous enameled. 25, 50, 75, 100, 150, 225, 300, 500, 750 and 1000-watt sizes.

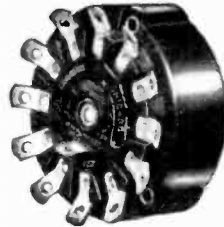

HIGH-CURRENT TAP SWITCHES

Compact, all ceramic, multi-point rotary selectors for A.C. use. Silver to silver contacts. Rated at 10, 15, 25, 50 and 100 amperes, with any number of taps up to 11, 12, 12, 12, and 8 respectively. Single or tandem.



RB-2 DIRECTION INDICATOR POTENTIOMETER

A compact, low cost unit used in a simple potentiometer circuit as a transmitting element to indicate, remotely, the position of a rotary-beam antenna. Used with a 0-1 milliammeter and 6-v. battery.

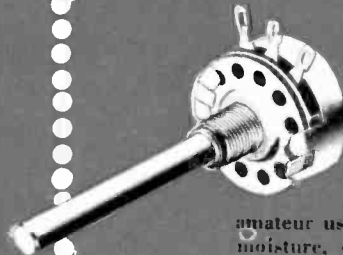

MOLDED COMPOSITION POTENTIOMETER

A high quality 2-watt unit with a good margin of safety, for industrial and amateur use. Unaffected by heat, cold, moisture, or length of service. Sold only through Ohmite distributors.

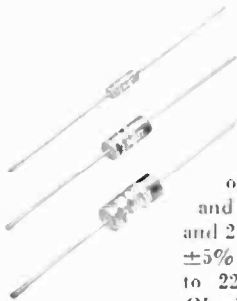

LITTLE DEVIL INDIVIDUALLY MARKED INSULATED COMPOSITION RESISTORS

New, tiny, molded fixed resistors each marked with resistance and wattage rating. $\frac{1}{2}$ Watt, 1 watt, and 2 watt sizes, $\pm 10\%$ tolerance. Also $\pm 5\%$ in $\frac{1}{2}$ and 1-watt sizes. 10 Ohms to 22 megohms. Sold only through Ohmite distributors.

HANDY OHM'S LAW CALCULATOR

Figures ohms, watts, volts, amperes—quickly, easily. Solves any Ohm's Law problem with one setting of the slide. New pocket size—9"x3" has all computing scales on one side. Resistor color code on back. Send 25¢ in coin to cover handling cost.

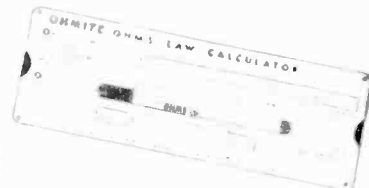

OHMITE

OHMITE MANUFACTURING COMPANY
4848 Flounoy Street, Chicago, U. S. A. Cable "Ohmiteco"



SEND FOR FREE CATALOG
Stock catalog lists hundreds of units, gives helpful information.

LOOK TO **Centralab**

First in component research that means lower costs for the electronic industry.

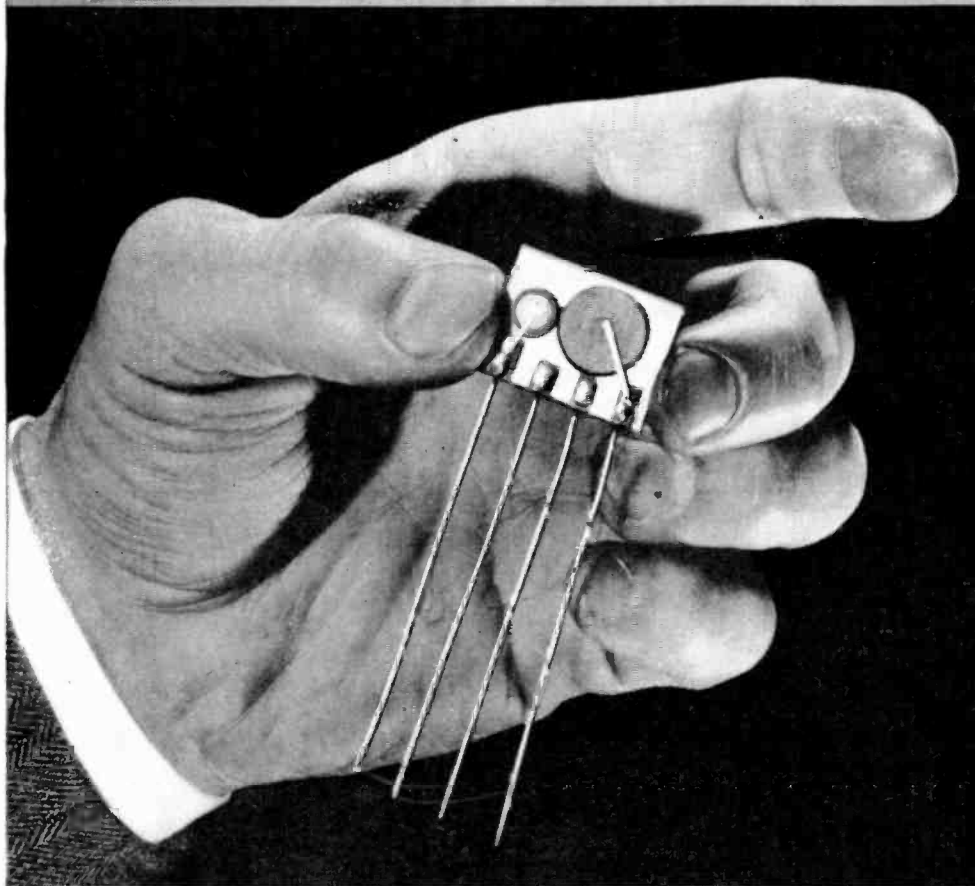

Here are Exclusive New **CENTRALAB** Developments

NEW Multi-Unit "Couplate" assures fast, precision wiring on interstage couplings. First commercial application of the "printed circuit", the *Couplate* is a complete interstage coupling circuit which combines into one compact unit the plate load resistor, the grid resistor, the plate by-pass capacitor and the coupling capacitor.

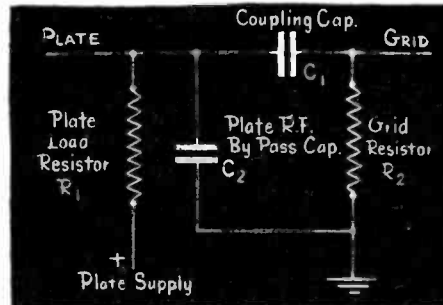

Each *Couplate* is an integral assembly of "Hi-Kap" capacitors and resistors closely bonded to a ceramic plate and mutually connected by metallic silver paths "printed" on the base plate.

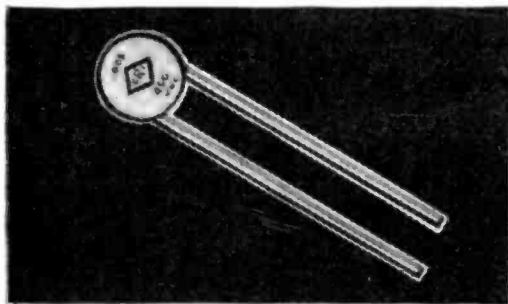

Diameter (Max. O. D.)	$\frac{5}{8}$ "
Thickness (Maximum)	$\frac{5}{32}$ "
W. V. D. C.	450
Guaranteed Min. Capac.	.005
Flash Test V. D. C.	900
Weight (Average)	1 gm. .035 oz.

Other capacity values available. Inquire now!

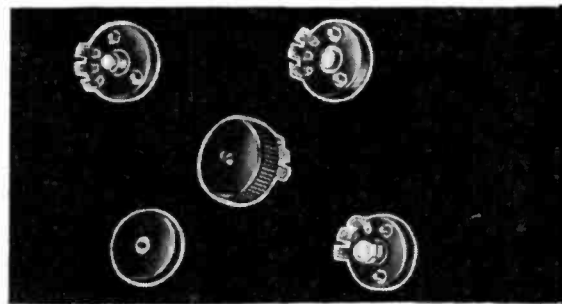

In addition, Centralab has just announced a sensational new quality line of miniature ceramic disc capacitors. "Hi-Kap" permanent Ceramic-X stability assures utmost reliability in small physical size and low mass weight.

"Hi-Kaps" are rated at a guaranteed minimum capacity for applications where close tolerances are unnecessary. Lowest minimum capacity will be exceeded by a substantial amount in all units.

Centralab's newest control is designed for miniature receivers, amplifiers, and hearing aids. No bigger than a dime, high quality performance is assured. It's perfect companion for sub-miniature tubes, batteries, etc.



For television units, "Hi-Vo-Kaps" offer high voltage, small size . . . as filter and by-pass capacitors in video amplifiers for high DC voltages with small component AC voltages. Choice of three terminal types,

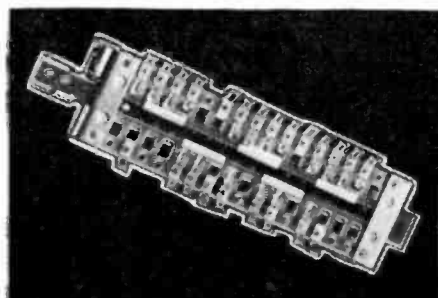

Revolutionary, new CRL Slide Switch saves space, allows short leads, convenient location to coils, reduced lead inductances for increased efficiency in low and high frequencies. Maximum reliability and long service life assured.

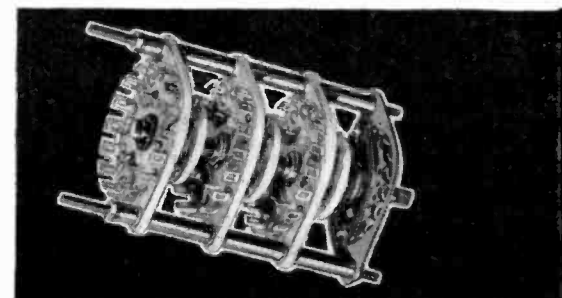

Specially designed for transmitters, power supply converters, X-ray equipment, etc., CRL medium-duty Power Switch gives efficient performance up to 20 megacycles. Minimum life operation of 25,000 cycles without failure.

BUY FROM **Centralab**

Makers of a complete line of components for the electronic industry.

SWITCHES . . . complete line featuring high quality, rugged construction for every type of electronic and industrial application.

- 1) "F" Index: for simple band change or radio-phono operations or general switching applications. V-spring. Life test — 5 positions — 10,000 cycles.
- 2) "G" Index: ideal for industrial applications. Coil spring replaceable without removing switch. Life test — 5 positions — 250,000 cycles.
- 3) "H" Index: (at right) primarily for band change and general tap switch applications. Spring and ball mechanism. Life test—5 positions—10,000 cycles.
- 4) Tone Switch: 3-4-6-8-9 or 10 clips available in tone switch group. All rated at 6 watts. Contact resistance less than $2\frac{3}{4}$ milliohms.
- 5) Lever Switch: features coil spring mechanism with index spring replaceable without removal of switch from chassis. Life test — 50,000 cycles.
- 6) Power Switch: designed for special industrial and electronic uses. Efficient performance up to 20 megacycles. Life test — 25,000 cycles.

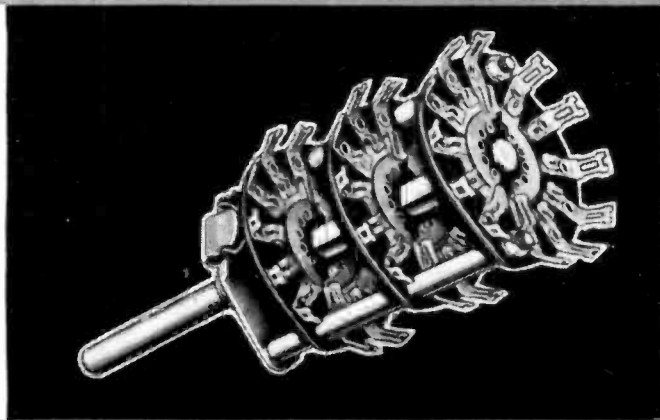

CONTROLS . . . full line featuring dependable performance, long life, low noise level and wide range of possible variations.

- 1) "R" Radiohms: two types — wire wound rated at 3 watts, composition rated at 1 watt. Both types can be twinned. Available with AC line switch.
- 2) "E" Radiohms: Composition type. Rubbing contact. 6 different resistance tapers. Rated at $\frac{1}{4}$ watt. Available with AC line switch.
- 3) "M" Radiohms: most versatile control of all. Composition type. Rated at $\frac{1}{2}$ watt. Can be twinned, tripled—twinned with switch or with concentric shaft.
- 4) "1" Radiohms: no bigger than a dime, for miniature receivers, amplifiers. Rating $\frac{1}{10}$ watt. Low noise level, shielded from dust, lint, etc.
- 5) Switch Covers: five types for "R" Radiohms, 4 types for "M" Radiohms, 1 type for "E" Radiohms. Rated at 3 amp. 125 volts, 1 amp. 250 volts.
- 6) Rheostats: for commercial use such as small motor speed controls, charging rate adjusters, etc. Two sizes available: 25 and 50 watt.

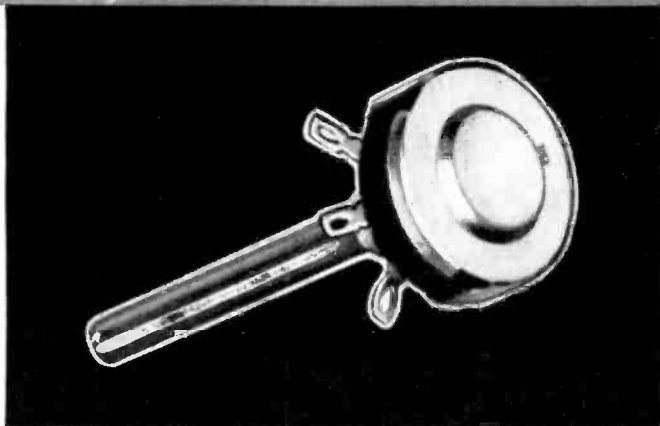

CAPACITORS . . . made with Centralab's high dielectric constant Ceramic-X, combining economy, convenient size and extreme dependability.

- 1) TC Tubulars: stable, having no appreciable change with aging, humidity or temperature. 4 sizes, capacity from 860 to 1 mmf., rated at 500 WVDC.
- 2) BC Tubulars: for use where temperature compensation is unimportant. Four tube sizes. Capacity from .000010 to .01 mfd., 500 WVDC.
- 3) High Accuracy: for rigid frequency control applications. Capacity tolerance, $\pm 5\%$. Standard working voltage 500 volts DC.
- 4) High Voltage: Capacity tolerance $\pm 10\%$. Five sizes from 5000 to 15,000 WVDC. Flashover voltage from 10,000 to 30,000 VDC.
- 5) Disc: miniature disc capacitors combining utmost reliability with small physical size, low mass weight. Diameter $\frac{3}{8}$ ". Thickness $\frac{5}{32}$ ".
- 6) Trimmers: four basic types. Working voltages 500 DC. Flash test 1100 VDC. Power factor, less than 0.2% at 1 megacycle.

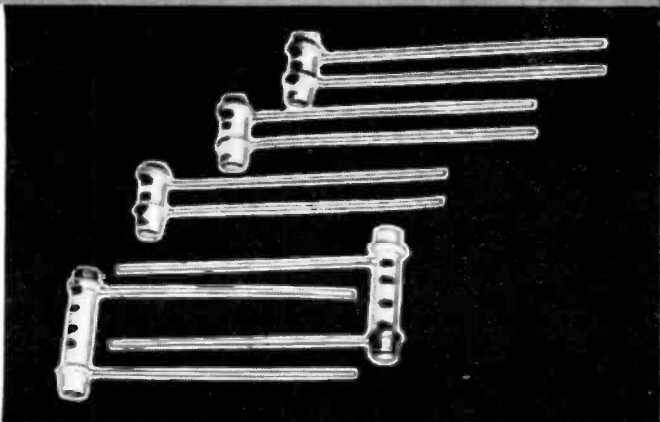

CERAMICS . . . engineered for special industrial and electrical applications requiring specific properties of hardness, coefficient of expansion, porosity.

- 1) Steatite: Uniform white, high dielectric strength, high mechanical strength, low dielectric loss at high frequencies. Impervious to moisture and common acids, does not warp in use, will withstand high temperature and its characteristics remain stable with age.
- 2) Centradite: For use where low thermal expansion and high resistance to heat shock is desired. Composed chiefly of Cordierite, a magnesium aluminum silicate crystalline material. White in color and low in porosity. Variations available for specific design and production needs.
- 3) Zirconite: Has low coefficient of expansion and good thermal shock properties plus high strength characteristics. Recommended for extruded or wet-pressed shapes. Variations of this material also available to meet specific design and production requirements.



CENTRALAB

Division of GLOBE-UNION INC. • Milwaukee, Wis.



DEPENDABLY ENGINEERED

**RADIO HARDWARE
WIRES AND CABLES**

Since 1923 — pioneers in the design and manufacture of Wires—Cables —Plastic and Push-back Hook-up Wires—Radio Hardware—Shielded Microphone Cable and S. J. Cable —also Ceramics, Porcelain and Steatite Insulators—Antennas, etc.

Specify and use "BIRNBACH" Products — an old, reliable name in the Radio-Electronic Industry. Complete stock at your Dealer.



BIRNBACH RADIO CO., Inc.

145 HUDSON ST.

NEW YORK, 13, N. Y.



BIRNBACH

THERE'S AN RCA TUBE

FOR EVERY AMATEUR SERVICE



RCA POWER TRIODES

806	1000 watts input* at 30 Mc.
808	300 watts input* at 30 Mc.
810	750 watts input* at 30 Mc.
811	225 watts input* at 60 Mc.
812	225 watts input* at 60 Mc.
833-A	1000 watts input* at 30 Mc.
8005	300 watts input* at 60 Mc.



RCA BEAM POWER TUBES

2E26	33 watts input* at 150 Mc.
807	75 watts input* at 60 Mc.
813	500 watts input* at 30 Mc.
815	68 watts input* at 150 Mc.
829-B	120 watts input* at 200 Mc.

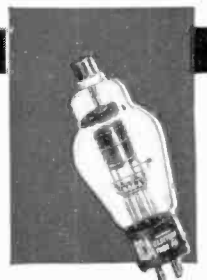

RCA RECTIFIERS AND THYRATRONS

5R4-GY	Full-wave, vacuum type. With choke input, 175 ma. at 750 volts.
816	Half-wave, mercury-vapor type. Two tubes in full-wave, 250 ma. up to 2380 volts.
866-A	Half-wave, mercury-vapor type. Two tubes in full-wave, 500 ma. up to 3180 volts.
2050	Gas thyratron. Up to 200 ma. at 400 volts in grid-controlled full-wave circuit.
5557	Mercury-vapor thyratron. Up to 1 amp. at 1500 volts in full-wave choke-input circuit.

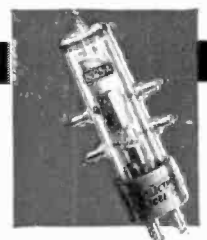

RCA UHF AND VHF TUBES

2C43	20 watts input* at 1500 Mc.
4-125A/4D21	500 watts input* at 125 Mc.
6C24	1000 watts input* at 160 Mc.
826	130 watts input* at 250 Mc.
8025-A	50 watts input* at 500 Mc.

*Maximum value, class C telegraphy service.

● RCA has a popular tube for every amateur service, every power and every active band. A few of the best-known types in each classification are listed.

In addition, there are special-application types, such as *voltage regulators, phototubes, acorns, kinescopes, iconoscopes*, and the well-known *receiving types* in metal, glass, and miniature.

Your local RCA Tube Distributor has complete technical data on all RCA tube types. Contact him for further information, or write RCA, Commercial Engineering, Section M-67, Harrison, New Jersey.

Free—RCA Headliners for Hams

... 4-page folder, gives power tube voltages, currents, driving power, dissipations, etc., for each tube service. Indispensable to every Amateur who builds transmitting equipment. Ask your RCA Tube Distributor for a copy of Headliners, or write RCA, Commercial Engineering, Section M-67, Harrison, New Jersey.



THE FOUNTAINHEAD OF MODERN TUBE DEVELOPMENT IS RCA



TUBE DEPARTMENT

RADIO CORPORATION of AMERICA

HARRISON, N. J.

There's a **C-D** capacitor



CORNELL-DUBILIER CAPACITORS

have long been noted for their extra measure of dependability and stability of electrical characteristics. Today — as radio digs deeper and deeper into V-H-F and U-H-F — this C-D "extra" gives hams complete assurance of accurate tuning, frequency stability, and uninterrupted operation.

Cornell-Dubilier Electric Corporation, Dept. AH8, South Plainfield, N. J. Other plants at New Bedford, Worcester and Brookline, Massachusetts, and Providence, Rhode Island.

KEEP YOUR RIG ON THE AIR — ON YOUR FREQUENCY WITH THESE C-D CAPACITORS

TYPE TJU

Dykanol transmitter filter capacitor — compact, safety-rated, supplied with universal mounting clamp and heavily-insulated terminals. Hermetically sealed against all climatic conditions. Housed in sturdy steel container, aluminum-painted non-corrosive finish. Can be mounted in any position. Extra high dielectric strength. Conservative D-C rating — triple tested. Wide range of capacity and voltage values available.

TYPE 59

Mica transmitter capacitor — extremely adaptable, dependable under the most severe operating conditions. In low-loss, white glazed ceramic case. Low-resistance, wide-path terminals. Can be mounted individually or stacked in groups for series or parallel combinations. For grid and plate blocking, coupling, tank and by-pass applications in hi-power ham transmitters.

TYPE 6

Mica transmitter capacitor for medium power rigs — designed for R-F applications where size and weight must be kept at minimum. Exclusive C-D patented series-stack mica construction. Impregnated for low loss, high insulation, prevention of air voids. Suited for grid, plate, coupling, tank and by-pass uses.

TYPE 1R

C-D "Silver-Mike" Silvered Mica Capacitors are for use in high Q electronic circuits where frequency stability and minimum loss must be maintained. They are ideally suited for use in circuits where the LC product must be maintained constant. All units are rated at 500 V.D.C. and tested at 1,000 V.D.C.

M I C A • P A P E R • D Y K A N O L

for every ham application

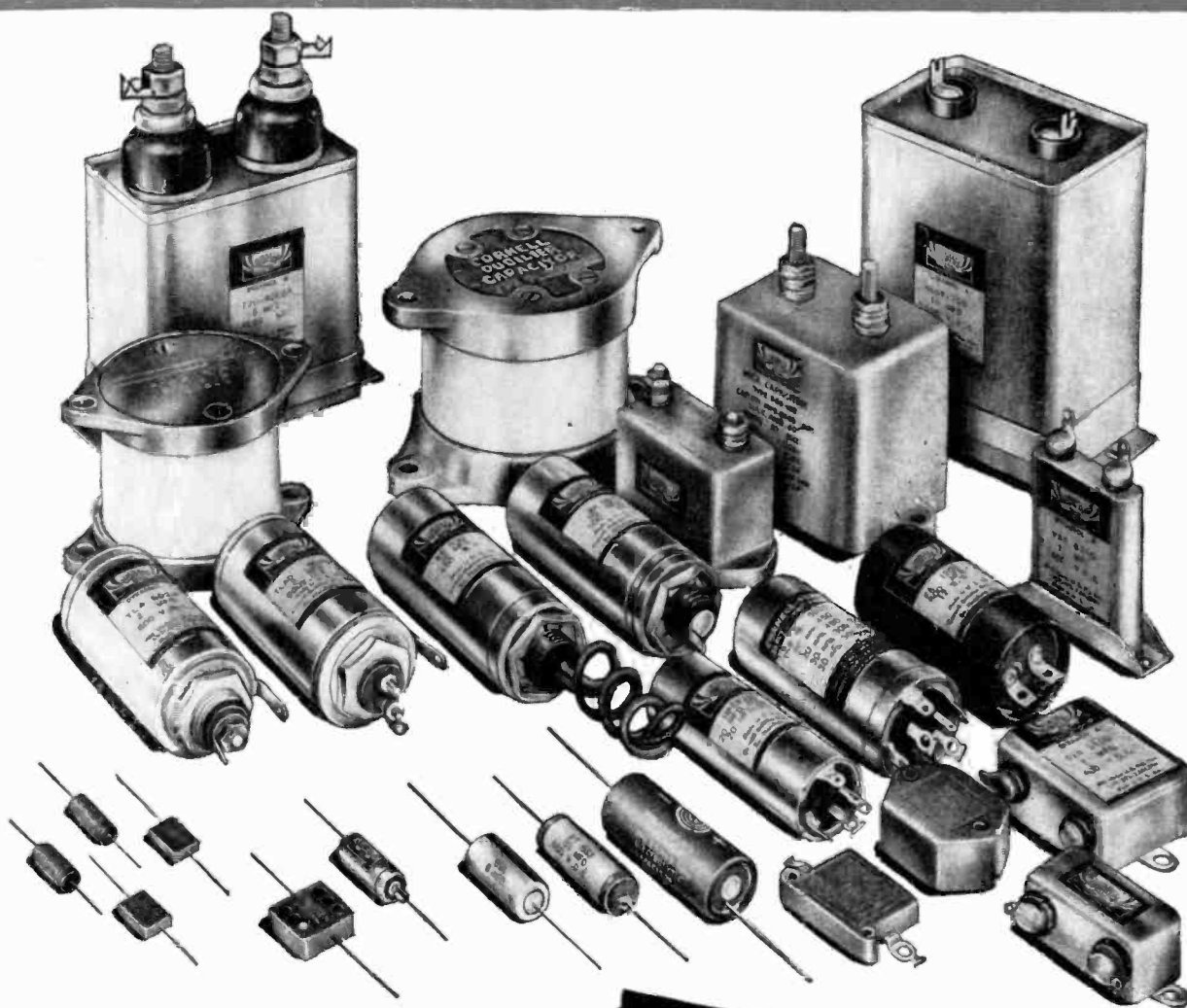

WRITE FOR YOUR
FREE COPY OF
CATALOG NO. 200

Gives helpful information and data
on C-D's complete line of Capacitors
for every ham application.



E L E C T R O L Y T I C

Mechanically Perfect Electrically Correct
COMPONENTS for RADIO and ELECTRONICS

Amphenol is devoting full facilities to the development and manufacture of quality components for radio and electronic applications to meet a myriad of peacetime needs. Amphenol technical knowledge, acquired through many years of experience and research and strengthened by extraordinary war-time production, is reflected in many new and improved products with heightened standards of quality and performance.

AMPHENOL

AMERICAN PHENOLIC CORPORATION
CHICAGO 50, ILLINOIS

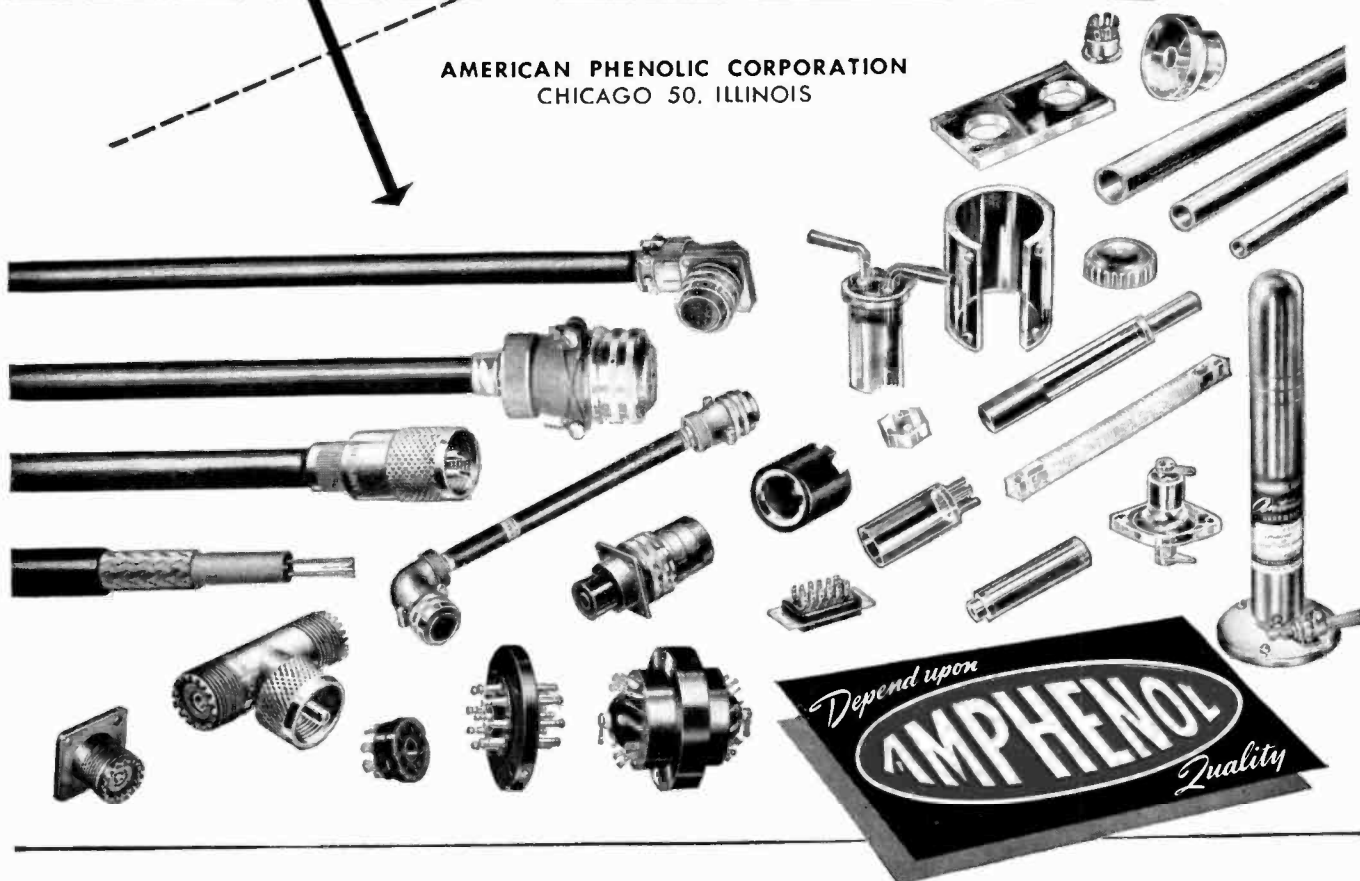

COAXIAL CABLES AND CONNECTORS • INDUSTRIAL CONNECTORS, FITTINGS AND CONDUIT • ANTENNAS • RADIO COMPONENTS • PLASTICS FOR ELECTRONICS

IT'S SYLVANIA FOR...

RADIO TUBES — CRYSTAL DIODES —



Lock-In Tube



Germanium Crystal Diode
1N34

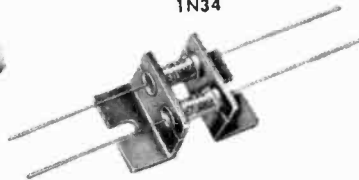

... and Duo-Diode 1N35

It can never be a hit or miss proposition when it comes to radio tubes manufactured by Sylvania Electric. Experiments for new and better materials for further improving Sylvania Radio Tubes are carried on constantly.

The famous Lock-In Tube, for example, is so mechanically rugged, so efficient electrically, that it can handle high and ultra-high frequency circuits with ease.

These diodes are well adapted for use as second detectors and d-c restorers in television receivers; frequency discriminators in FM circuits; first detectors; modulators and demodulators.

Supplied in tiny cartridges, they require no heater supply or adjustment and may be wired directly into circuits by means of tinned copper leads.

TRANSMITTING TUBES — SPECIAL ELECTRONIC TUBES —



3D24



GB-302

GG-304

First of Sylvania's new line of transmitting tubes, the 3D24 is a four-electrode amplifier and oscillator with 45 watt anode dissipation. An outstanding development is the electronic graphite anode, which allows high plate dissipation for small area and maintains constant inter-electrode relationship and uniform tube characteristics.

For the first time, counter tubes with *stable, uniform characteristics* are now available for practical use in the field of radioactivity. The GB-302 beta-ray tube will be very valuable in tracer techniques in industry, research and medicine, especially in medical diagnosis and therapy. Sylvania Type GG-304, the gamma-ray counting companion to the GB-302, is useful in radiological safety surveys and other applications where gamma radiation must be efficiently measured. In addition, the GG-304 can be used for cosmic ray studies, particularly in coincidence work.

ELECTRONIC DEVICES



3-inch Cathode Ray
Tube Oscilloscope,
Type 131

This instrument is especially useful in rapid receiver alignment and trouble-shooting. Controls are easily accessible. Hood shades face of cathode ray tube permitting use of instrument in well-lighted room. This 3-inch cathode ray tube is shock-mounted and shielded against stray fields.

Cabinet is steel construction, ventilated with louvers, and finished in attractive pearl-gray baked enamel. Easily carried; weighs only 18 pounds. Eight-foot power cord provided for quick installation.

These quality products of Sylvania Electric indicate the scope of manufacturing facilities constantly serv-

ing all phases of the radio industry. *Sylvania Electric Products Inc., Radio Tube Division, Emporium, Pa.*

SYLVANIA ELECTRIC

MAKERS OF RADIO TUBES; CATHODE RAY TUBES; ELECTRONIC DEVICES; FLUORESCENT LAMPS, FIXTURES, WIRING DEVICES; ELECTRIC LIGHT BULBS

Collins transmitters, excitors, receiver and variable frequency oscillator for Amateurs

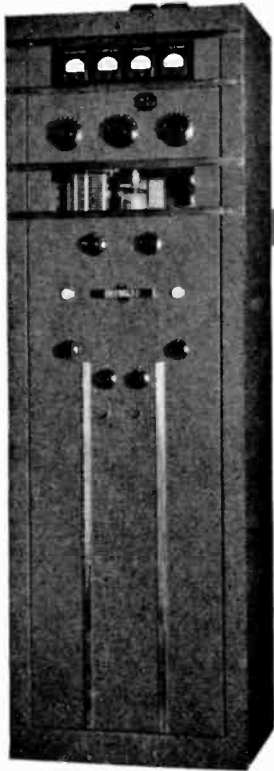

30K-1 TRANSMITTER

500 watts CW, 375 watts phone input

The Collins 30K-1 is a versatile, reliable band-switching transmitter for the 80, 40, 20, 15, 11 and 10 meter bands. It has an audio peak clipping circuit which permits running the audio gain at a high level, thus maintaining a high level of modulation. With the circuit set to become operative at 90% modulation, the carrier will not be overmodulated, and the increased audio power in the carrier side bands strengthens the signal and improves intelligibility.

Bandswitching eliminates coil changing with the exception of the antenna tuning network, in which an antenna impedance matching circuit is incorporated. Two separate plug-in coils are supplied for this position, one covering 80 and 40 meters, the other covering 20, 15, 11 and 10 meters. This circuit efficiently couples the 30K-1 to any antenna or transmission lines approximating an integral number of $\frac{1}{4}$ or $\frac{1}{2}$ wave lengths.

TUBE LINE-UP: 1—4-125A r-f power amplifier
1—6SJ7 speech amplifier
1—6SN7 audio amplifier
1—6H6 speech clipper
1—6B4G modulator driver
2—75TH Class B modulators
1—5R4GY bias rectifier
1—5R4GY low voltage rectifier
2—866A high voltage rectifiers

Dimensions: 22" wide, 16 $\frac{1}{2}$ " deep, 66 $\frac{1}{2}$ " high.

Power source: 115 volts a-c, 60 cps, single phase.

Net price (complete with tubes), including 310A-1 Exciter Unit (complete with tubes), Microphone Cord, R.F. Cable, Power Cable, and Instruction Book, F.O.B. Cedar Rapids, Iowa..... \$1,450.00

310A EXCITER UNIT

The bandswitching 310A exciter unit for the 30K-1 has a highly stable permeability tuned oscillator. All circuits are ganged together and controlled by a single tuning knob. The band-lighted dial is calibrated directly in frequency and is adjusted at the factory to an accuracy of better than one dial division on 40 meters. Accuracy on the other bands is directly proportional to the harmonic utilized. The output circuit is also adjusted at the factory for proper excitation of the 30K-1.

TUBE LINE-UP: 1—6SJ7 PTO
1—6AG7 buffer amplifier
1—6AG7 doubler
1—807 multiplier
1—807 output
2—VR105 voltage regulators
1—5R4GY rectifier
1—6x5 bias rectifier

Dimensions: 17 $\frac{1}{4}$ " wide, 12 $\frac{1}{2}$ " deep, 10 $\frac{1}{2}$ " high.

Power source: 115 volts a-c, 60 cps, single phase.



75A RECEIVER

80, 40, 20, 15, 11 and 10 meter bands

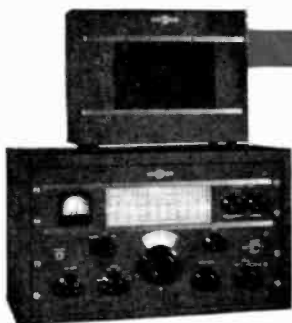

Double conversion and crystal filter controls, with a high frequency first i-f and a low frequency second i-f, provide approximately 50 db image rejection, even on 10 meters, and a bandwidth that is variable in 5 steps from 4 kc to 200 cycles at 2X down. A 2 microvolt r-f signal across the antenna terminals gives normal output with approximately 6 db signal to noise ratio. Precision quartz crystals in the first conversion circuit, the inherent accuracy and stability of the Collins v.f.o. in the second conversion circuit, and linearity and lack of backlash in the tuning mechanism, all contribute to extreme accuracy and stability. Visual tuning is adjusted at the factory to better than 1 division

of the band-lighted dial, which reads directly in frequency. Line voltage fluctuations from 90 to 120 volts cause the pitch of a code signal to change less than 100 cycles at 21,500,000 cycles (no voltage regulator tube used).

Dimensions: 21 $\frac{1}{8}$ " wide, 12 $\frac{1}{4}$ " high, 13 $\frac{7}{8}$ " deep.

Power source: 115 volts a-c, 60 cps, single phase.

Net price, complete with 14 tubes (including rectifier), Speaker and Cabinet assembly and Instruction Book, F.O.B. Cedar Rapids, Iowa..... \$375.00

32V TRANSMITTER

150 watts CW, 120 watts phone

A receiver-type cabinet houses the complete bandswitching transmitter—r-f (v.f.o. controlled), audio, power supply, and a network for antenna tuning and impedance matching. The v.f.o. is more accurate and stable than most crystals used by amateurs. All stages except the final are permeability tuned. The 32V can be visually tuned with a high degree of accuracy directly in frequency on the band-lighted dial. Audio distortion is less than 8% at 90% modulation with 1000 cps input. The frequency re-

sponse is within 2 db from 200-3000 cps. Frequency coverage: 80, 40, 20, 15, 11 and 10 meter bands. The 32V may be used for either permanent or portable installations. The only requirements are a simple antenna, a 115 volt a-c power source, and a key or microphone. It may also be used to drive a kilowatt final r-f stage and modulator.

Net price, complete with tubes and Instruction Book, F.O.B. Cedar Rapids, Iowa . . . \$475.00



TUBE LINE-UP:

- 1—6SJ7 oscillator
- 1—6AK6 Class A r-f buffer
- 1—6AG7 harmonic amplifier
- 1—7C5 buffer doubler
- 1—7C5 buffer doubler
- 1—4D32 r-f power amplifier
- 1—6SL7 audio amplifier
- 1—6SN7 audio amplifier
- 2—807 modulators
- 1—5Z4 L. V. rectifier
- 2—5R4GY H. V. rectifiers
- 1—OA3/VR75 bias regulator

COLLINS PTO EXCITER UNITS

The Collins 310B-1 and 310C-2 exciters provide not only the flexibility and convenience of variable frequency, but also the accurate calibration and high stability inherent in the Collins 70E-8 permeability tuned oscillator. Frequency is read directly from the dial with precision comparable to that of crystals. There are no reference charts or curves to interpolate. Like all Collins equipment shown on these pages, the 310B-1 and 310C-2 are engineered for extreme frequency stability in spite of line voltage fluctuations.

Both of these exciters have self-contained power supplies. A third, the 310C-1, is similar to the 310C-2, minus power supply.

Net prices, complete with tubes and Instruction Book, F.O.B. Cedar Rapids, Iowa:

310B-1 Exciter Unit	\$190.00
310C-1 Exciter Unit	85.00
310C-2 Exciter Unit	100.00



The 310B-1 is a versatile bandswitching exciter unit, conservatively rated at 15 watts output on all amateur bands under 32 megacycles, and can be used as a complete low power cw transmitter. It has ample drive for a kilowatt final utilizing

the new pentode tubes available. With additional multiplication it makes an excellent frequency control for amateur bands in the VHF and UHF regions.

310B-1

310C-2

The 310C-2 consists of a 70E-8 PTO and a multiplier, with an r-f output of approximately 80 volts rms across 40,000 ohms. Its frequency range is from 3.2 mc to 4.0 mc. Its output can be plugged into the crystal socket, or applied to the

grid of an 807 buffer stage, thus providing a versatility far greater than any number of crystals, while at the same time maintaining crystal accuracy and stability.



70E-8 VARIABLE FREQUENCY OSCILLATOR



The Collins 70E-8 v.f.o., which is incorporated in the 310B-1, 310C-1 and 310C-2 exciters above, may be purchased separately as illustrated. It is permeability tuned, and has a linear range of 1600 kc-2000 kc. Its overall accuracy and stability are of a very high degree. A secondary frequency standard, continually checked against WWV, is used in the factory calibration of the 70E-8. A special corrector mechanism in the oscillator produces the linear calibration curve. Sixteen turns of the vernier dial are required to cover the 400 kc range. This v.f.o. may be used

in an exciter, or in many types of measuring instruments such as heterodyne frequency meters and band-edge spotters.

Net price, complete with tube, Collins type 305H-2 Dial Assembly and Instruction Book, F.O.B. Cedar Rapids, Iowa \$40.00

For best results in amateur radio, it's . . .



COLLINS RADIO COMPANY, Cedar Rapids, Iowa

11 West 42nd Street, New York 18, N. Y.

458 South Spring Street, Los Angeles 13, Calif.

SILVER

SPELLS TOP VALUE AT LOWEST COST

Exactly as SILVER is known the world over for producing Laboratory Caliber Electronic Test Instruments — LCETI — for critical users at unbelievably low prices, so you'll find that your dollars will buy you the most in amateur equipment when you select SILVER. Examine the instruments here illustrated and highlighted. Compare — and you'll see why more and more amateurs turn to SILVER.



908

MODEL 908 MICROMATCH standing wave ratio and r.f. wattmeter will let you put more power into your antenna — from your present transmitter — for only **\$29.90**.



800

MODEL 800 U.H.F. RECEIVER is E. P. Tilton's A.R.R.L. HANDBOOK, "T.R.F. Superregenerative Receiver" — the sweetest performing 2½ and 1¼ meter, non-radiating receiver we've seen — in finished commercial form for only **\$39.75** less tubes and power supply.



700

MODEL 700 U.H.F. TRANSMITTER is xtal controlled for maximum signaling effectiveness in 2½ and 1¼ meter bands, yet costs you only **\$36.95** less tubes and power supply.



701

MODEL 701 TRANSMITTER goes into more amateur stations to produce more CW and phone DX than anything else, it seems. A 6AQ5 Tritet drives an 807 to 75 watts CW, 30 watts phone, input, 80 through 6 meters. Modulator is built-in. Less coils (3 per band at \$.50 ea.), power supply, 4 tubes and crystal, it's the outstanding transmitter "buy" at **\$36.95**.



801

MODEL 801 RECEIVER covers 450 kc. through 60 mc., consisting of r.f. stage, regenerative detector, two a.f. stages and built-in speaker. It's the old reliable standby — just the thing for portable, emergency, test — and serious ham reception. **\$29.95** for 6.3 volt operation; **\$28.95** for 1.5 volt dry battery tubes; coils, **\$1.00** per pair.

MODEL 703 is new — a pre-tuned bandpass freq. multiplier. Driven by any VFO or xtal, it puts you in any band 80 through 6 meters, on selected freq. as fast as you can turn two knobs. Its 807 gives 40 watts max. output and instant control of every band. Price **\$49.90**.

MODEL 802 SUPER-HETERODYNE RECEIVER is an amateur-band-only receiver using i.f. regeneration to give variable phone up to single-signal CW selectivity. Following A.R.R.L. HANDBOOK teachings, it provides more than usual 8-tube results, over 7 feet of band spread on 80, 40, 20, 16, 11, 10 and 6 meter bands, all for only **\$38.95** less tubes, power supply and coils at **\$1.00** per pair.

MODEL 903 ABSORPTION WAVEMETER is close to the most useful instrument in any shack. Thousands in use attest its prime necessity. Price is but **\$3.30** net, plus **\$.65** ea. for plug-in coils covering 1600 kc. up to 500 mc.

MODEL 702 VFO includes NFM. Covering 3,000 through 4,000 kc., its 3-watt output may be multiplied 80 through 2½ meters. It's something brand new — a crystal controlled VFO including and using a 5 mc. xtal frequency standard to give complete break-in operation, superbly clean keying — the VFO you've dreamed would come. Only **\$49.90** less tubes, including power supply.

TYPE 619 AIR TRIMMER CAPACITORS are high Q, low-loss, good up beyond 500 mc. for tuning, trimming, coupling, etc. 3 mmfd. to 30 mmfd. spread out over 3 complete revolutions for easy adjustment. Like all SILVER instruments, price is more than right — only **\$.30** ea., net.

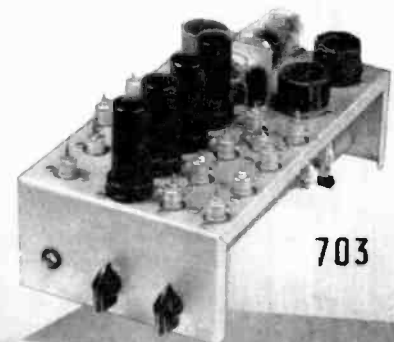

703



802

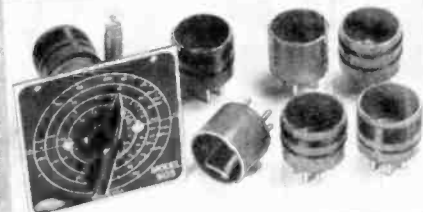

903



702

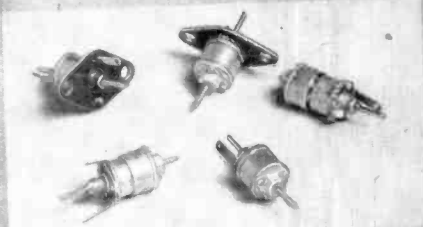

619

OVER 36 YEARS OF RADIO ENGINEERING ACHIEVEMENT

McMurdo Silver Co., Inc.

EXECUTIVE OFFICES: 1240 MAIN ST., HARTFORD 3, CONN.
FACTORY OFFICE: 1249 MAIN ST., HARTFORD 3, CONN.

See these new, top-value-and - performance instruments at your favorite jobber. Send for complete catalog including SILVER Laboratory Caliber Electronic Test Instruments.



TO HELP YOU PICK THE BEST

Here are a few facts to help you choose the best: In approximately 90% of the new commercial mobile transmitter designs, you will find Hytron instant-heating tubes. Over 2,500,000 Hytron gaseous voltage regulators speak for themselves. Ratings of Hytron vhf tubes are CCS and based on actual equipment performance which you can duplicate. No other transmitting triode can touch the new all-purpose 5514 for economical versatility. Famed for transmitting tubes, Hytron also originated the popular "GT", and is the oldest manufacturer specializing in receiving tubes. You pick the best when you pick Hytron.

HYTRON TRANSMITTING AND SPECIAL PURPOSE TUBES CONTINUOUS COMMERCIAL SERVICE RATINGS

Description	Type No.	Filament Ratings		Type	Max Plate Volts	Max Plate Ma	Max Plate Dis	Amateur Net Price
		Volts	Amps					
LOW AND MEDIUM MU TRIODES	10Y	7.5	1.25	Thor	450	65	15	\$1.60
	HY24	2	0.13	Oxide	180	20	2	1.50
HIGH-MU TRIODES	801A/801	7.5	1.25	Thor	600	70	20	3.00
	864	1.1	0.25	Oxide	135	5	—	1.20
VHF TRIODES	1626	12.6	0.25	Cath	250	25	5	1.60
	HY31Z †	6	2.55	Thor	500	150*	30*	3.95
	HY1231Z †	6	3.2	Thor	500	150*	30*	4.50
BEAM PENTODES AND PENTODES	5514 †	7.5	3	Thor	1500	175	65	3.95
	2C26A	6.3	1.15	Cath	3500	NOTE	10	7.75
	HY75A †	6.3	2.6	Thor	450	90	15	3.95
	HY1148 †	1.4	0.155	Oxide	180	12	1.8	2.25
	HY615	6.3	0.175	Cath	300	20	3.5	2.25
	955	6.3	0.15	Cath	200	8	1.8	3.10
ACORNS MINIA-TURES	90C2	6.3	0.15	Cath	200	8	1.8	2.15
	2E25 †	6	0.8	Thor	450	75	15	3.95
	2E30 †	6	0.65	Oxide	250	60	10	2.25
	3D21A	6.3	1.7	Cath	3500	NOTE	15	7.50
RECTIFIERS	HY69 †	6	1.6	Thor	600	100	30	3.95
	807	6.3	0.9	Cath	600	120	25	2.30
	837	12.6	0.7	Cath	500	80	12	4.15
RECTIFIERS	HY1269 †	6	3.2	Thor	750	120	30	4.50
	1625	12.6	0.45	Cath	600	120	25	2.30
	5516 †	6	0.7	Oxide	600	90	15	5.95
RECTIFIERS	954	6.3	0.15	Cath	Sharp cutoff pentode			4.90
	9001	6.3	0.15	Cath	Sharp cutoff pentode			2.70
	RECTIFIERS	Type No.	Filament Volts	Ratings Amps	Type Rect	Peak Plate Ma	Max D-C Ma †	Inv Peak Por.
816		2.5	2.0	Mer	500	250	5000	\$1.25
866A/866		2.5	5.0	Mer	1000	500	10000	1.75
REGULATORS	1616	2.5	5.0	Vac	800	260	6000	7.50
	GASEOUS VOLTAGE REGULATORS	Type No.	Average Operating Voltage	Operating Ma Min	Max	Av Volts Reg	Min Starting Voltage	Amateur Net Price
		OA2	150	5	30	2	185	\$2.30
OB2		108	5	30	1	133	2.30	
REGULATORS	OC3/VR105	108	5	40	2	133	1.20	
	OD3/VR150	150	5	40	3.5	185	1.20	

*Both sections of twin triode. NOTE: Special pulse tube, not recommended for c-w, consult Hytron Commercial Engineering Dept. for data. †5514 supplants the HY30Z, HY40, HY40Z, HY51A, HY51B, and HY51Z, the HY75A the HY75, and the 2E25 the HY65. ‡Current for full wave. §Instant-heating.

For better reception, it's also Hytron — GT, G, lock-in, or miniature.



New data sheets: 2E25, 2E30, HY31Z, HY69, HY75A, HY1231Z, HY1269, 5514, 5516. Free.

Keep up to date with the Hytron Reference Guide for Miniature Electron Tubes. Free.

New transmitting and special purpose tube catalogue. It's yours for the asking.

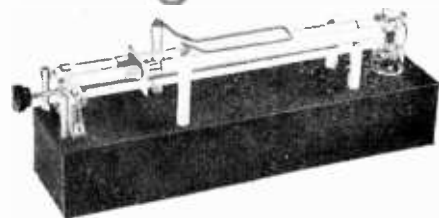

Simple, sure-fire vfo for 1 1/4 or 2 meters. HY-Q 75 kit: unassembled, \$9.95; assembled, \$11.95.

HYTRON RADIO & ELECTRONICS CORP.

SALEM, MASSACHUSETTS

TRANSFORMERS FOR EVERY APPLICATION

LINEAR
STANDARD



HYPERM
ALLOY



ULTRA
COMPACT



COMMERCIAL
GRADE

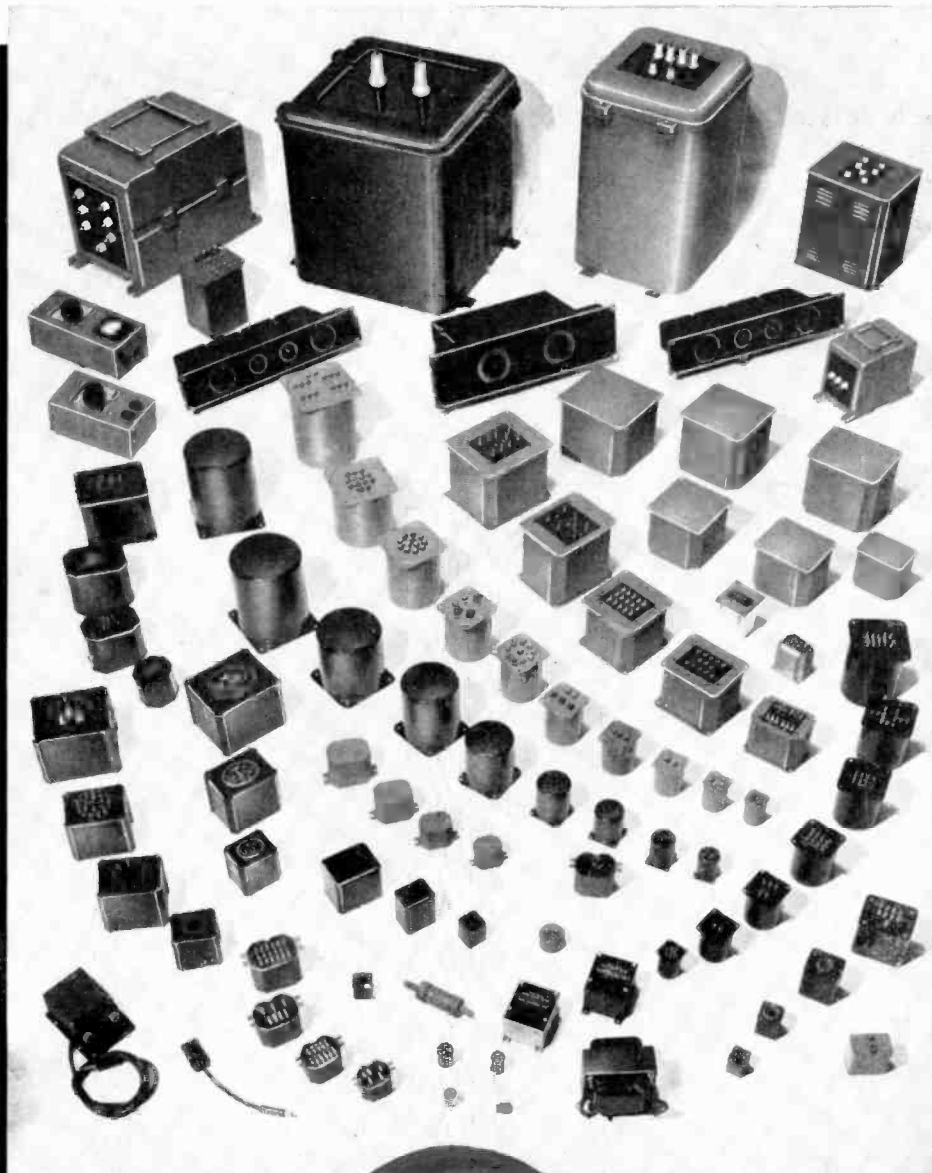

OUNCER



SUB
OUNCER



SPECIAL
SERIES



VARIABLE
INDUCTOR



Foremost Manufacturers of Transformers for the Amateur

United Transformer Corp.

150 VARICK STREET

NEW YORK 13, N. Y.

EXPORT DIVISION: 13 EAST 40th STREET, NEW YORK 16, N. Y.,

CABLES: "ARLAB"

the **LITTLE**
differences
make the **BIG**
differences

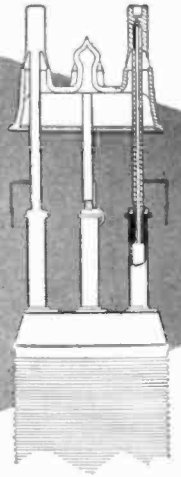

Would you say there's a little or a big difference between a winner and a loser? And could a loser be a winner? No, we're not being philosophic . . . we're just thinking about the Amperex ZB3200.

This tube is a winner but that's because it's also a good loser. In tubes, one of the problems is to lose heat efficiently but in such a way that we prevent overheating of the glass-to-metal seals. So even though the plate terminals are that special Amperex copper one-piece construction, feather-edge seals to glass, we wanted to keep the heat away from them. To do this we chose tubular supports; molybdenum next to the anode to withstand the high temperature but with a thin wall to reduce thermal conduction and large outer surface to increase radiation; then a smaller tube of nickel to connect to the one-piece copper terminal, nickel because it is also a good loser in the heat conduction race but has the required strength and rigidity. So we start out with two losers and wind up with a winner.

Now this isn't exactly a "little" difference, but we do have hundreds of little and medium-size differences in the design and construction of the many transmitting, rectifying and special purpose tubes that comprise the extensive Amperex line.

Write for Amperex catalog listing tubes for amateur radio application.



re-tube with Amperex

**AMPEREX
ELECTRONIC
CORPORATION**



25 WASHINGTON STREET, BROOKLYN 1, N. Y.
In Canada and Newfoundland: Rogers Majestic Limited
11-19 Brentcliffe Road, Leaside, Toronto, Ontario, Canada



Knock at Any Ham Shack Door...

Knock at a thousand ham shack doors—*anywhere*—and the chances are you'll find ALLIED-supplied station equipment and a file of well-thumbed ALLIED Catalogs in *most* of them. . . .

Amateurs everywhere—for more than 25 years—have looked *first* to ALLIED as their most dependable supply source. "*Equipped by ALLIED*" has become a popular phrase, descriptive of thousands of fine amateur stations all over the country and abroad.

Our large staff of hams, who share your interest in Amateur radio, see to it year-in and year-out that ALLIED has ready for immediate shipment at the lowest prices, the world's largest stocks of quality station equipment. Try us. Count on us. We'll deliver the goods to your shack door—and stay right with you on any and all of your problems. . . .



WRITE FOR YOUR COPY OF THE
LATEST ALLIED CATALOG

IN AMATEUR RADIO

ALLIED RADIO

FOR OVER 25 YEARS

833 W. JACKSON BLVD., DEPT. 67-8
CHICAGO 7, ILLINOIS

Always First with the Latest
Largest Stocks in the World
Lowest Prevailing Prices
ImmEDIATE Shipment
Easiest Time Payments
Dependable Ham Service



FM & TV ANTENNAS

for the
**PEAK OF
RECEPTION**

**ANTENNA
SYSTEMS**

manufactured under

**PRIVATE LABELS
and TRADE MARKS**

for
AUTOMOBILES
and
RESIDENTIAL
AM • FM • TV

Our engineers will cooperate in designing collapsible and transmitting antennas for every purpose, for quantity production.

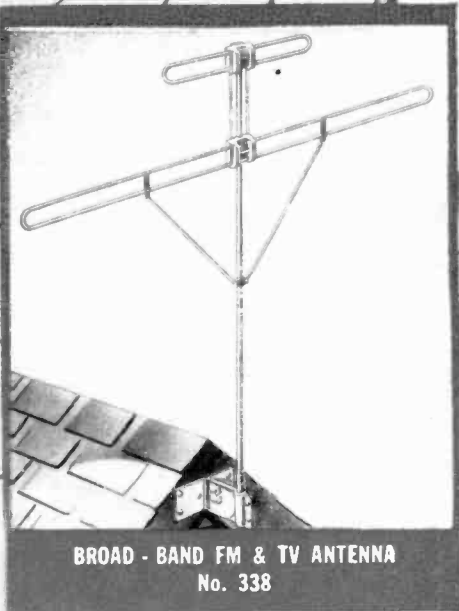

BROAD - BAND FM & TV ANTENNA
No. 338

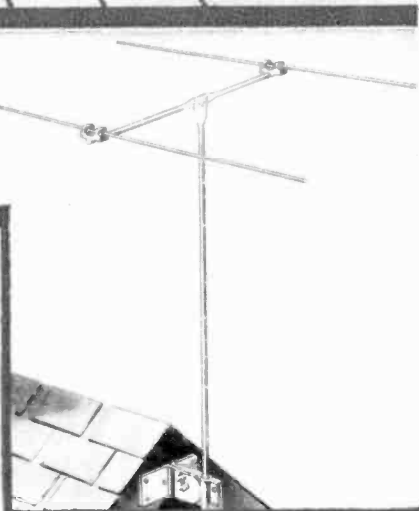

STRAIGHT DIPOLE & REFLECTOR
FM ANTENNA No. 339

**WRITE FOR
SPECIFICATION SHEETS**

SOME OF THE OTHER **BRACH** PRODUCTS

Puratone Signal Booster for noise-free store demonstrations—carries AM, FM and Television Antennas all on the same mast • Lightning Protective Devices • Junction Boxes • Pot Heads • Gas Relays • Arrester Housings • Protective Panels • Solderall • Terminals and Housings • High Tension Detectors • Test-O-Lite for Circuits 100-550 AC or DC.

**L.S. BRACH
MFG. CORP.**

ESTABLISHED 1906

200 CENTRAL AVENUE
NEWARK 4, N. J.

WORLD'S OLDEST AND LARGEST
MANUFACTURERS OF RADIO ANTENNAS
AND ACCESSORIES.

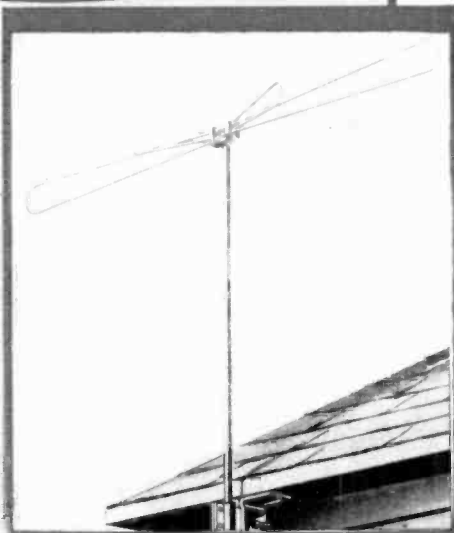

MULTI - BAND FM & TV ANTENNA
No. 344

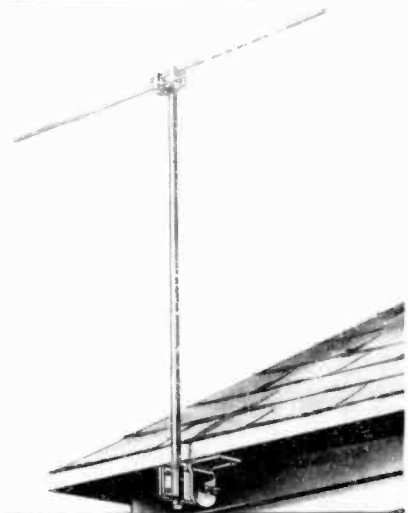

STRAIGHT DIPOLE
FM ANTENNA No. 334

**EASILY AND QUICKLY INSTALLED
WITH THE**

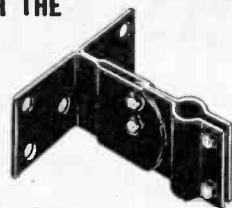

BRACH UNIVERSAL BASE MOUNT

HARVEY'S *is ham* headquarters

Sonny got started right. Dad has been a Harvey customer since 1927, though he lives miles from New York. When Sonny got his ticket Dad told him to get his gear from Harvey's because he'd get the best, the quickest service, and friendly help and advice on his problems. Dad knows that Harvey's staff is made up of hams who know the ham's problems and can usually come up with a solution. If you live in or near New York, this friendly service is more direct but it can't be more personal.



HARVEY'S HIT OF THE MONTH

Watch this space in our QST ad each month. In it you'll find bargains in items you can really use.

HARVEY'S HAMFESTIVAL OF VALUES

You'll find Harvey's ad each month in QST and in this space you'll see offerings of unusual value in addition to the staples of ham radio. Harvey carries large stocks of components including meters, crystals, transmitting tubes and test equipment along with the complete units including all the popular receivers, transmitters, frequency meters and other things that add up to a complete ham station.

Harvey's reputation for reliability has been growing ever since 1927 and you can be sure of the same prompt, courteous attention if you order by mail, wire, or phone as if you could call and place your order in person. By the way, if you get near Times Square, we're only a block away, so drop in and see us.

W2DIO
W2FXB
W2IJJ
W2KWY
W2LJA

Telephone:  LOngacre 3-1800

HRC
HARVEY
RADIO COMPANY INC.

103 West 43rd St., New York 18, N. Y.

Get your name on our mailing list. Send us a postcard or letter, stating whether you are amateur, serviceman or engineer. We'll keep you posted on merchandise available, new equipment and special Harvey bargains.

What you should know about POST WAR CRYSTALS



Because of the lack of accurate information supplied the ham fraternity, more than ordinary trouble is being experienced in getting post-war crystals to operate properly. Regardless of make, many amateurs are having difficulty with frequency drift and with chirps when the oscillator is keyed. Because hams are a curious group, who want the facts, here they are!

Good post-war crystals are definitely superior to pre-war types—in applications for which they were intended.

The new post-war crystals are nearly all AT or BT cuts, with a temperature coefficient of less than 2 parts per million per degree Centigrade, compared to old pre-war X or Y cuts with 23 to 100 parts per million.

About 1940, equipment manufacturers and the Armed Forces wanted better crystals—and realized that to have them, crystals were to be used for frequency control—not for the handling of huge amounts of power. Thus smaller crystals were satisfactory, and with drift but 10% of what it used to be, the use of a huge plate to dissipate heat was no longer necessary. These crystals met the military

demands for they also possessed excellent activity.

Prior to the war, acid etching was almost unknown. Crystals were finished with abrasive. This led to "aging"—a gradual increase in frequency as small chips broken loose by the abrasive came off the surface of the crystal—and reduced activity. By acid etching as it is done at the James Knights plant, crystals are "stabilized" so these effects were eliminated and increased activity was achieved. Ham equipment was usually designed to use the pre-war, less active, unetched crystals. Unless precautions are taken, the new crystal when plugged into old type equipment frequently results in excessive heat and fracturing due to violent activity.

The solution is simple—reduce crystal current and see what fine performers these new crystals really are!

A word about some of the surplus variety: many are quickly lapped into a ham band without etching.

For the convenience of amateurs, James Knights manufactures a complete line of crystals in both the 1/2" and 3/4" pin spacing.



3/4" pin spacing in a frequency range of 2,000 to 20,000KC.

H173

Crystals for the Critical



NEW 10 METER CRYSTAL

No special circuit required. Third mode crystals, 27 to 29.7 MC hermetically sealed, with standard 1/2" pin spacing. Also available in 25 MC for doubling to 6 meters.

Price \$4.95.



1/2" pin spacing, frequency range 2,000 to 20,000 KC.

The JAMES KNIGHTS Co.
SANDWICH, ILLINOIS

Manufacturers of a Complete Line of Industrial, Broadcast, Communication and Amateur Crystals.
WRITE FOR ILLUS. CATALOGS



BOB HENRY'S PLATFORM

LOW PRICES

I guarantee to sell to you as cheap as you can buy anywhere.

COMPLETE STOCKS

Hallicrafters, National, Hammarlund, Collins, Millen, RME, Pierson, Temco, Meissner, Supreme Transmitters, Meck, Gordon, Amphenol-Mims, RCA, Vibroplex, Sonar, all other amateur receivers, transmitters, beams, parts, etc. If it is amateur or communications equipment—I can supply it.

QUICK DELIVERY

Mail, phone, or wire your order. *Shipment within four hours.*

EASY TERMS

I have the world's best time sale plan because I finance the terms myself. I save you time and money. I cooperate with you. Write for details.

LIBERAL TRADE-IN ALLOWANCE

Other jobbers say I allow too much. Tell me what you have to trade and what you want.

TEN DAY FREE TRIAL

Try any receiver ten days, return it for full refund if not satisfied.

FREE NINETY DAY SERVICE

I service everything I sell free for 90 days. At a reasonable price after 90 days.

FREE TECHNICAL ADVICE

and personal attention and help on your inquiries and problems.

*Write, wire
or phone today*

*Orders from outside continental
U.S.A. also welcomed*

Butler, Missouri

HENRY RADIO STORES

Los Angeles 25, Calif.

"WORLD'S LARGEST DISTRIBUTORS OF SHORT WAVE RECEIVERS"

Laboratory Standards

MODEL 78-FM STANDARD SIGNAL GENERATOR
86 to 108 megacycles. Output: 1 to 100,000 microvolts

MODEL 84 U.H.F. STANDARD SIGNAL GENERATOR
300 to 1000 megacycles, AM and Pulse Modulation

MODEL 62 VACUUM TUBE VOLTMETER
0 to 100 volts AC, DC and RF

MODEL 71 SQUARE WAVE GENERATOR
5 to 100,000 cycles
Rise Rate 400 volts per microsecond

MODEL 58 U.H.F. RADIO NOISE AND FIELD STRENGTH METER
15 to 150 megacycles

MODEL 65-B STANDARD SIGNAL GENERATOR
75 to 30,000 kilocycles
M.O.P.A., 100% Modulation

MODEL 80 STANDARD SIGNAL GENERATOR
2 to 400 megacycles
AM and Pulse Modulation

MODEL 79-B PULSE GENERATOR
50 to 100,000 cycles
0.5 to 40 microsecond pulse width

Standards are only as reliable as the reputation of their maker

MEASUREMENTS CORPORATION
BOONTON • NEW JERSEY

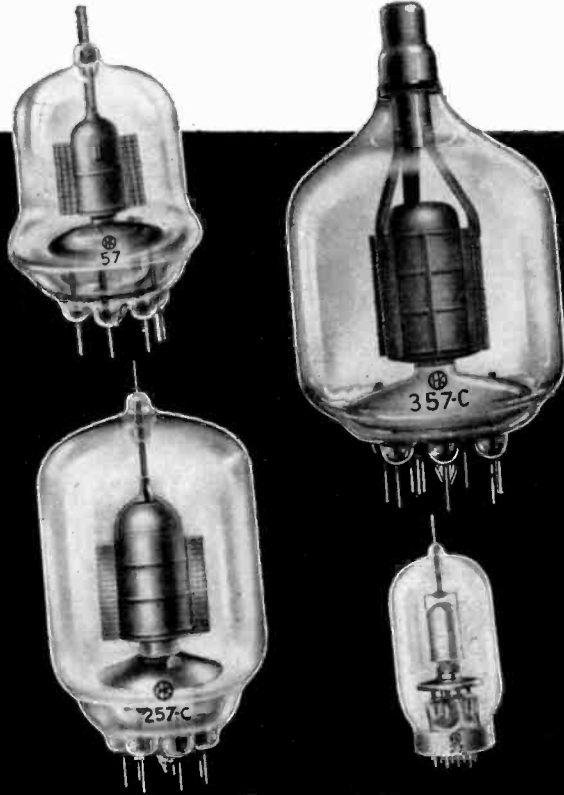

Four new HK pentodes with higher wattage, higher frequency ratings

Four new Gammatron pentodes, with power output ratings from 25 to 750 watts, and maximum frequency ratings from 100 to 200 Mc. are the most recent additions to the HK line.

The HK-27 is a small radiation cooled instant-heating pentode ideal for mobile installations, operating efficiently throughout the VHF band. The HK-257C is similar to the widely used 257B, but has a higher maximum frequency, and lower interelectrode capacitances. The two other new Gammatron pentodes are the HK-57 and 357C.

You can rely on the electrical and mechanical ruggedness of Gammatron tubes. Their reputation for endurance and long life is based on 20 years of amateur, emergency and government communication service.

SEND FOR DATA SHEET ON ANY OF THESE

Gammatrons



Gammatron Tube Division
HEINTZ AND KAUFMAN LTD.

South San Francisco · California
Communications Equipment Division · 50 Drumm Street
San Francisco · California

TYPE NO.	24	246	27*	54	57*	254	257B*	257C*	304L	304H	354C	354E	357C*	454L	454H	654	854L	854H	1054L
MAX. POWER OUTPUT: Class 'C' R.F.	90	90	50	250	250	500	400	400	1220	1220	615	615	750	900	900	1400	1800	1820	3000
PLATE DISSIPATION: Watts	25	25	25	50	75 [‡] 50 [‡]	100	125 [‡] 100 [‡]	125 [‡] 100 [‡]	300	300	150	150	250	250	250	300	450	450	750
AVERAGE AMPLIFICATION FACTOR	25	25	-	27	-	25	-	-	10	19	14	35	-	14	30	22	14	30	13.5
MAX. RATINGS. Plate Volts	2000	2000	1000	3000	3000	4000	4000	4000	3000	3000	4000	4000	5000	5000	5000	4000	6000	6000	6000
Plate M.A.	75	75	100	150	150	225	225	225	1000	1000	300	300	375	375	375	600	600	600	1000
Grid M.A.	25	25	10	30	15	40	25	25	150	150	60	60	70	20	60	100	80	80	125
MAX. FREQUENCY, Mc.: Power Amplifier	200	300	200	200	200	175	200	125	175	175	50	50	150	150	150	50	125	125	100
INTERELECTRODE CAP: C _{g-p} u.u.f.	1.7	1.6	0.035	1.8	0.05	3.6	0.08	0.04	9	10.5	3.8	3.8	0.08	3.4	3.4	5.5	5	4	5
C _{g-f} u.u.f.	2.5	1.8	5.7%	2.1	7.29%	3.3	10.5%	6.2%	12	14	4.5	4.5	11.9%	4.6	4.6	6.2	6	8	8
C _{p-f} u.u.f.	0.4	0.2	2.9*	0.5	3.13*	1.0	4.7*	4.5*	0.8	1.0	1.1	1.1	4.6*	1.4	1.4	1.5	0.5	0.5	0.8
FILAMENT: Volts	6.3	6.3	6.3	5.0	5.0	5.0	5.0	5.0	5.10	5.10	5	5	5.0	5	5	7.5	7.5	7.5	7.5
Amperes	3	3	3.0	5	5.0	7.5	7.5	7.5	26.13	26.13	10	10	10.0	11	11	15	12	12	21
PHYSICAL: Length, inches	4 1/4	4 1/4	4	5 1/16	4 1/4	7	6 3/4	5 1/4	7 3/4	7 3/4	9	9	6 1/2	10	10	10 3/4	12 3/4	12 3/4	16 1/2
Diameter, inches	1 3/8	1 3/8	1 1/2	2	2 3/8	2 3/8	2 1/2	2 1/2	3 3/8	3 3/8	3 3/8	3 3/8	3 3/8	3 3/8	3 3/8	3 3/8	5	5	7
Weight, Oz.	1 1/2	1 1/2	1 1/2	2 1/2	2 1/2	2 1/2	5 1/2	3 1/2	9	9	6 3/4	6 3/4	7	14	14	14	14	14	42
Base	Small UX	Small UX	Small Octal	Std. UX	#247 Johnson	Std. 50 Watt	7 Pin	#247 Johnson	Johnson #213	Johnson #213	Std. 50 Watt	Std. 50 Watt	Special	Std. 50 Watt	Std. 50 Watt	Std. 50 Watt	Std. 50 Watt	Std. 50 Watt	Johnson #214

* Beam pentode † Input • Output ‡ Intermittent telegraph rating † Constant key down rating

RIDER Radio Publications

UNDERSTANDING MICROWAVES

BY VICTOR J. YOUNG. For those who have not previously considered radio waves shorter than 10 centimeters. Provides foundation for understanding various microwave developments of past five years.

CHAPTER HEADS: The Ultra High Frequency Concept; Stationary Charge and Its Field; Magnetostatics; Alternating Current and Lumped Constants; Transmission Lines; Poynting's Vector and Maxwell's Equations; Wave-guides; Resonant Cavities; Antennas and Microwave Oscillators; Radar and Comities; Section Two is devoted to descriptions of Microwave Terms, Ideas and Theorems. Index. 400 Pages—Price \$6.00.

A-C CALCULATION CHARTS

BY R. LORENZEN. Students and engineers will find this book invaluable. Simplifies and speeds work involving AC calculations. Contains 146 charts. Covers AC calculations from 10 cycles to 1000 megacycles. 160 Pages—Price \$7.50.

INSIDE THE VACUUM TUBE

BY JOHN F. RIDER. A new approach and technique that makes its message easy to understand. Here is a solid, elementary concept of the theory and operation of the basic types of vacuum tubes based on the electro static field theory. Throughout the entire book, which covers diodes, triodes, tetrodes, and pentodes, the aim is to present a clear physical picture of exactly what is happening in a vacuum tube, inclusive of the development of characteristic curves of all kinds, and associated load lines.

A goldmine for the student; a must for the libraries of servicemen, amateurs and engineers. 425 Pages—Price \$4.50.

THE CATHODE-RAY TUBE AT WORK

BY JOHN F. RIDER. This book presents a complete explanation of the various types of cathode-ray tubes and what role each element within the device plays in making voltages and currents visible. The only book of its kind!

This volume offers a complete and elaborate, easy to understand explanation of the theory of the tube. It is this information, with many hundreds of typical oscillograms illustrating practical applications, which makes this book so valuable. 338 Pages. 450 Illustrations—Price \$4.00.

RIDER MANUALS—FOR RADIO TROUBLE SHOOTING

Unchallenged authority in the field of radio servicing reference books. Containing receiver schematics, voltage data, alignment data, resistance values, chassis layouts and wiring and trimmer connection material they aid in quick location of faults in ailing receivers. Sixteen volumes cover all important American made receivers issued from 1920 to early months of 1947 inclusive.

VOLUME XVI (including "HOW IT WORKS" Book)	\$ 6.60
VOLUME XV (including 181 pg. "HOW IT WORKS" Book)	18.00
VOLUME XIV to VII. Each volume	15.00
VOLUME VI	11.00
ABRIDGED VOLUMES I to V (1 volume)	17.50
RECORD CHANGERS and RECORDERS	9.00

AN HOUR A DAY WITH RIDER SERIES

D.C. VOLTAGE DISTRIBUTION IN RADIO RECEIVERS—The applications of Ohm's law, practically interpreted in terms of how circuits are employed in radio receivers.

ALTERNATING CURRENTS IN RADIO RECEIVERS—An exposition on fundamentals of alternating currents and voltages and where they appear in receiving system.

RESONANCE AND ALIGNMENT—The importance of the subject in relation to all communication systems, and the clarity of this text, have produced a sale of over 50,000 of this title.

AUTOMATIC VOLUME CONTROL—An easy to understand explanation of how avc is utilized in radio receivers,

96 PAGES EACH (ILLUSTRATED)—\$1.25 EACH

JOHN F. RIDER PUBLISHER, INC.

404 FOURTH AVENUE, NEW YORK 16, N. Y.

EXPORT AGENT: ROCKE-INTERNATIONAL CORP., 13 East 40th Street, New York 16, N. Y. Cable ARLAB
Publishers Exclusively for the Radio and Electronic Industry

FOR PUBLICATION IN WINTER OF 1947-48

F-M Transmission and Reception
Broadcast Operator's Handbook
The Signal Generator at Work
R-F and I-F Selectivity
Understanding Low Power Transmitters
Adjusting Transmitters with Oscilloscope
Installing and Servicing Low-Power P-A Systems
Understanding Vectors and Phase in Radio Work

Watch for Publication Dates

FREQUENCY MODULATION

One of the most talked-of developments in radio field; details of F-M receiver maintenance and how it differs from A-M. 136 Pages—81 Illustrations—\$2.00.

SERVICING BY SIGNAL TRACING

Explains approved system of diagnosing faults in radio receivers and all kinds of communication systems. The method was introduced by the author of the book, John F. Rider. The system has won endorsement by individuals and associations the world over as well as technical branches of our government. 360 Pages—188 Illustrations—\$4.00. Spanish edition—\$4.00.

VACUUM TUBE VOLTMETERS

Explains the theory upon which the functioning of the different types of v-t voltmeters is based, and also the practical applications of these instruments. Includes a bibliography consisting of 145 international references. 180 Pages—111 Illustrations—\$2.50.

THE METER AT WORK

How each type of meter works and how each is used in the field to best advantage. Covers whichever phase of the subject the reader is interested in. 152 Pages—138 Illustrations—\$2.00.

THE OSCILLATOR AT WORK

Shows how various oscillator circuits function and methods to improve their performance. Also describes the r-f and a-f oscillators used as signal sources. Covers laboratory test methods, and other related tests. 256 Pages—167 Illustrations—\$2.50.

SERVICING RECEIVERS BY MEANS OF RESISTANCE MEASUREMENT

Discusses series and parallel combinations of resistances and the distribution of currents and voltages, providing the basis underlying the circuit arrangements used in various types of radio receivers. Also discusses application of resistance measurement to radio servicing. 203 Pages—94 Illustrations—\$2.00.

AUTOMATIC FREQUENCY CONTROL SYSTEMS

The basic operation of the discriminator and Automatic Frequency control circuits is explained in great detail in the first part of the book. Descriptions of systems used in commercial receivers are fully described in the second part. 144 Pages—102 Illustrations—\$1.75.

ALIGNING PHILCO RECEIVERS

I.F. peaks—adjustment frequencies—trimmer and pad locations—complete and detailed information for aligning every Philco model from 1929 to 1941. Covers 7,000,000 Receivers. \$2.00
VOL. I—1929 to 1936—176 Pages..... 2.00
VOL. II—1937 to 1941—200 Pages..... 2.00

RADAR

A non-technical explanation of the operating principles of Radar. 72 Pages—Unique Illustrations—\$1.00.

SEND FOR
LATEST CATALOG



"QUIET" PHONOGRAPH REPRODUCTION

is now Achieved with Astatic's
NEW CRYSTAL CARTRIDGE

Contributing immeasurably to improved QUIET and QUALITY in phonograph reproduction, Astatic's advanced model "QT" Crystal Pickup Cartridge has been extensively approved and adapted by the industry. Here is a cartridge engineered with a matched sapphire or metal tipped needle, having all the qualities of a permanent needle, plus the advantage of being replaceable. Possessing those characteristics essential to more quiet, faithful reproduction, Astatic's Model "QT" Cartridge is highly recommended for modern home record player installations.



Astatic
MODEL "QT"
CRYSTAL
CARTRIDGE
with Matched
Replaceable
Needle



NEEDLES FOR
"QT" CARTRIDGE
Above: Precious Metal
Stylus
Below: Sapphire Stylus

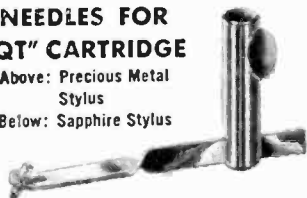

Crystal and Dynamic
M I C R O P H O N E S
PHONOGRAPH PICKUPS
CARTRIDGES
& RECORDING HEADS

All inquiries or requests for literature given prompt attention.

THE *Astatic*
ASTATIC CORPORATION
CONNEAUT, OHIO

IN CANADA: CANADIAN ASTATIC LTD. TORONTO, ONTARIO

Astatic Crystal Devices Manufactured
under Brush Development Co. patents.

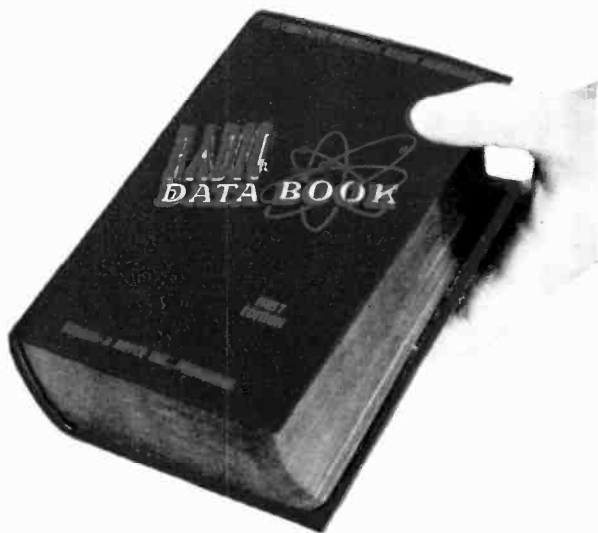

THE RADIO DATA BOOK

All data and basic knowledge in radio and electronics digested into 12 sections . . . over 1000 pages in a complete, quick to find, easy to read, handbook form.

Plan every operation in radio and electronics with the Radio Data Book. This new radio bible will be your lifelong tool . . . you will use it every day, on the board, at the bench, in the field. Use it for construction, troubleshooting and testing. The RADIO DATA BOOK will be your invaluable aid in design, experiment and in layout. It will help make your production better, faster and easier. In any and every operation in radio and electronics, you will use the RADIO DATA BOOK.

The RADIO DATA BOOK is a work of complete authority, prepared by engineers with many years of practical experience. They have been assisted by the Boland & Boyce staff of editors skilled in preparing electronics manuals for the U.S. Signal Corps for many years. These men have worked for several years gathering material for this book . . . all the knowledge of radio principles and operation . . . all the statistics . . . all the newest developments in electronics . . . every possible angle and detail. Eighteen months were spent digesting this material into the most concise, the clearest, and the most readable form. The result is this invaluable manual . . . The RADIO DATA BOOK. Whether you use this book for general reference, for scientific instruction, or for education, one thing is certain—the practical help, the daily usefulness you will derive from it will prove to be worth many, many times its astonishingly low price.

Advanced Sale . . . first printing. Only 10,000 available. . . . To make sure to get your RADIO DATA BOOK, mail your order NOW!

- 12 sections . . . 1000 pages . . . Completely illustrated
- Section 1. THE 150 BASIC CIRCUITS IN RADIO.
 - Section 2. COMPLETE TEST EQUIPMENT DATA.
 - Section 3. TESTING, MEASURING AND ALIGNMENT.
 - Section 4. ALL ABOUT ANTENNAS.
 - Section 5. SOUND SYSTEMS.
 - Section 6. ELECTRICAL AND PHYSICAL CHARACTERISTICS OF RADIO COMPONENTS.
 - Section 7. COMPLETE TUBE MANUAL.
 - Section 8. CHARTS, GRAPHS AND CURVES.
 - Section 9. CODES, SYMBOLS AND STANDARDS
 - Section 10. 50 TESTED CIRCUITS DESIGNED FOR OPTIMUM PERFORMANCE
 - Section 11. DICTIONARY OF RADIO AND ELECTRONIC TERMS.
 - Section 12. RADIO BOOK BIBLIOGRAPHY.

Handsomely Bound in Red & Gold
12 complete books in one, only \$5.00!
Less than 42c per book!



THE VIDEO HANDBOOK

Everything in Television in one Complete Text-book. Over 500 pages completely illustrated.

This new handbook will be invaluable to everyone concerned with technical Television. Everything in basic theory of television through the design, construction and production of receivers to final installation, operation and maintenance is covered. This is a completely new book that includes all of the latest developments in the field—the components discussed are of the newest design . . . the practical maintenance described is a result of intensive study and operation of equipment during the last two years.

There are five completely illustrated sections in the VIDEO HANDBOOK, each over a hundred pages long. Each section completely covers one phase of television. They can be referred to constantly in any type of work dealing with this rapidly expanding field. Television transmission is thoroughly explained in order to broaden the understanding of Video reception. The techniques of receiver design are analyzed technically and from a standpoint of economics. The problems of installation of receivers and antennas are clarified, and all instructions are presented in detail. How to operate equipment for optimum satisfaction is thoroughly explained, and complete maintenance of all existing components is clearly and carefully outlined—stage by stage—part by part.

No matter what your interest or position in the world of Radio and Television is—you will want the VIDEO HANDBOOK for your reference. You will want to read it for its vital, monumental story of a great new industry. And you will want it for it can help YOU make Television even greater.

Advanced sale, first printing . . . to make sure you get your VIDEO HANDBOOK send in your order today; it's an investment that will pay off day after day for years to come!

THE VIDEO HANDBOOK

- Section One—Theory
- Section Two—Design
- Section Three—Installation
- Section Four—Operation
- Section Five—Maintenance

500 completely illustrated pages handsomely bound in red and gold only \$5.00!

Send in your order TODAY . . . \$5.00 for either book or \$9.00 for BOTH

BOLAND & BOYCE INC., PUBLISHERS

460 BLOOMFIELD AVE., MONTCLAIR 10, N.J.

PAR-METAL *Standard* RACKS, CABINETS CHASSIS, PANELS

Adaptable for Every Requirement



Par-Metal Housings for Electronic Apparatus offer new features, including beautiful streamlined design, rugged construction, and adaptability. Eliminate need for Special Made-to-Order units on many jobs. Par-Metal offers standard ready-to-use housings for every type of transmitting or receiving apparatus.

Par-Metal offers all the essential equipment needed to build up any sort of a job—from a Small Receiver to a Deluxe Broadcasting System.



PAR-METAL PRODUCTS CORPORATION

32-62 49th Street,

Long Island City 3, N.Y.

ROCKE INT. CORP.,

Export Dept.

13 E. 40th St.,

New York 16, N.Y.

**WRITE FOR
CATALOG**

NOW AVAILABLE *for Amateurs*

STANCOR'S

ST-202-A
*Transmitter
Kit*



Here is a Versatile Transmitter that was Definitely Designed to Please the Amateur

LISTED at the right are some of the more salient features embodied in the ST-202-A. For complete details see your Stancor distributor or write direct for a descriptive bulletin.

Amateur net price of ST-202-A Complete Transmitter Kit, less accessories . . . \$92⁸⁰

STANCOR QUALITY TRANSFORMERS

The amateurs' acceptance of Stancor transformers results from the consistent maintenance of high standards of engineering, quality materials and precision manufacturing. Be familiar with our complete line of transformers and reactors by having a Stancor catalog for reference.

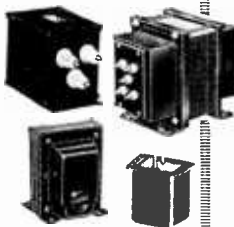

SEE YOUR STANCOR DISTRIBUTOR OR WRITE DIRECT FOR A COMPLETE CATALOG

STANDARD TRANSFORMER CORPORATION

ELSTON, KEDZIE AND ADDISON

CHICAGO 18, ILLINOIS



featuring . . .

- 100-125 WATTS INPUT TO FINAL AMPLIFIER.
- COVERS ALL AMATEUR BANDS BETWEEN 3.5 AND 30 MCS.
- THREE STAGE R. F. CIRCUIT.
- BAND SWITCHING OF EXCITER STAGES.
- ONLY TWO TUNING CONTROLS (EXCITER AND AMPLIFIER).
- SELECTION OF SIX CRYSTAL POSITIONS.
- ADJUSTABLE LINK OUTPUT CIRCUIT.
- TWO SEPARATE POWER SUPPLIES INCLUDED.
- EASE OF CONSTRUCTION (CABLED WIRING HARNESS SUPPLIED).
- SMALL SIZE — APPROXIMATELY 14" x 13" x 9".
- PROVISIONS FOR USE WITH AM OR FM MODULATOR.
- PRICED RIGHT.

"USEFUL INFORMATION FOR THE DX MAN"

DX

An indispensable operating aid, CQ DX is a comprehensive HANDBOOK profusely illustrated with full page charts and maps, containing over 15 chapters covering the following basic subjects: The Technique of Working DX—DX Predictions—QSL Cards—QSL Bureaus of the World—International Letter Postage and Airmail Rates—Standard Time Tick and Frequency Services—Worked All Zones DX System—World Zone Boundaries Defined—The United States—International Time—World Country Lists cross-indexed three different ways—International Amateur Codes—Useful Information for the DXers—etc.

Make DXing easier, extracting the QSLs, simpler. CQ DX, the HANDBOOK for the DX man, is available from your local amateur radio supply house. Order your copy now. Price 50 cents.

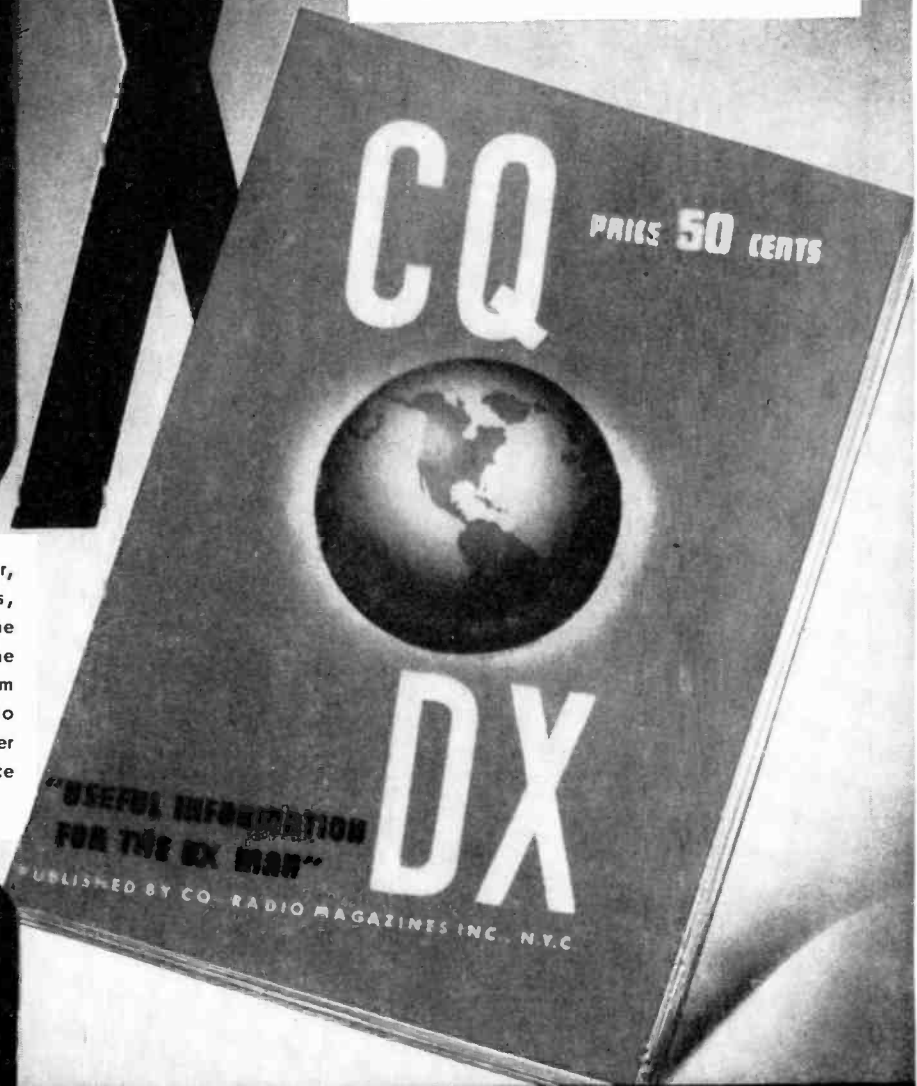

CQ

PUBLISHED by RADIO MAGAZINES, INC.
342 Madison Av., New York 17, N. Y.

CQ

The Radio Amateurs' Journal

35¢

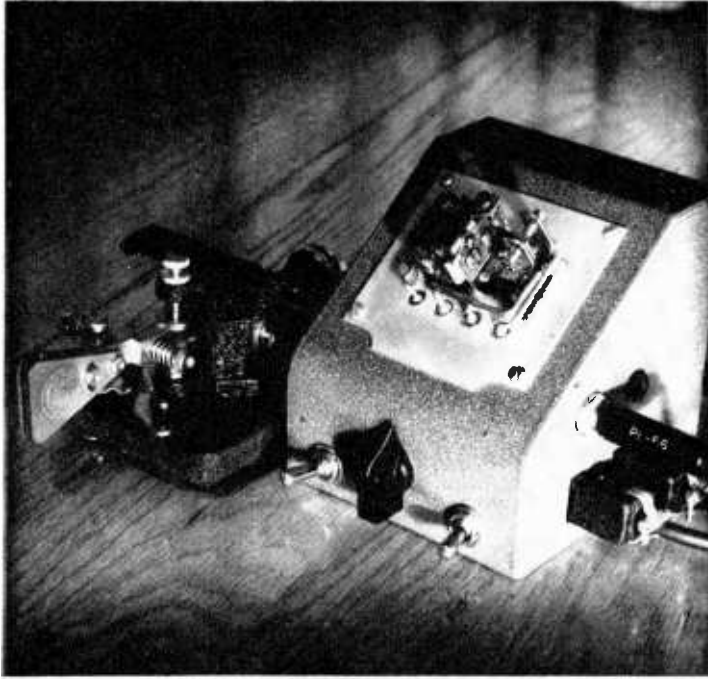

Published by RADIO MAGAZINES, INC. Subscription \$2.50 a year

- More Articles
- Topnotch Authors
- Bigger Departments
- Special Inserts
- Flat Mailing

The demand for copies of "CQ" exceeds the supply. Be sure of getting your copy every month by subscribing now. Use the coupon below. Attach your check or money order. Don't send cash by mail!

Subscription Prices

12 issues \$2.50

24 issues 4.00

In U. S. A. & Possessions and Canada.

Elsewhere \$3.50 for 1 yr. \$6.00 for 2 yrs.

No subs. accepted for more than 2 years.

Special reduced rates for "Ham" Clubs sent on request.

CQ is sold by leading "Ham" Dealers and on better news stands for 35c per copy.

—TEAR OUT—MAIL TODAY—

CQ-RADIO MAGAZINES, INC.
342 MADISON AVE., NEW YORK 17, N. Y.

Sirs: Here is my check (or money order) for \$.....
12 issues \$2.50—24 issues \$4. (Foreign subscriptions are \$1.00 higher per year.)

Please indicate: NEW RENEWAL

Subscriber's Name (print carefully)

Address

City..... State..... Zone.....

Call

Send me.....issues of CQ.

NOTICE TO
Engineers, Purchasing Agents, Experimenters, Amateurs

There's only one

RADIO'S MASTER

The only official
Radio and Electronic
equipment source-book

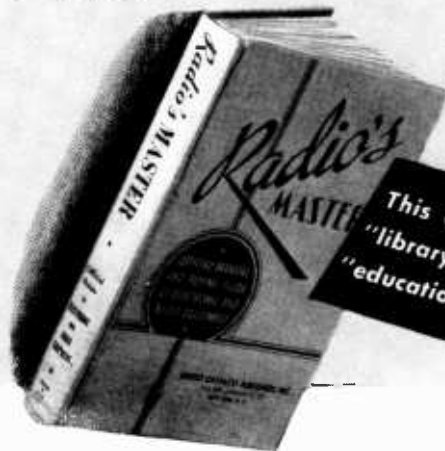

New 12TH EDITION

This complete 1070 page, one volume
"library" of facts and data is a veritable
"education" itself on Radio & Electronics!

CONTAINS
over 1000 pages!

Electronic Devices
Antennas
Photoelectric Units
Test Equipment
Recording Devices
Switches, Plugs
Coils, Relays
Transmitting &
Receiving Tubes
Transmitters
P.A. Equipment
Transformers
Controls, Condensers
Insulators
and many thousands of
other items

RADIO'S MASTER tells you:

What

the product does, its specifications, comparable and competing items . . . Thousands of illustrations . . . Data covers 90% of all products in the industry, each item indexed and cross indexed.

How much

Prices on thousands of items, all clearly catalogued for easy buying.

Who

makes it. Directory of manufacturers alphabetically listed, with page numbers for instant reference.

Where

you can get it. Your nearest sources that can supply your radio and electronic requirements. Saves time . . . Eliminates bulky files.

\$550

You'll find it FASTER in RADIO'S MASTER

\$6.00 outside of U.S.A.

UNITED CATALOG

PUBLISHERS INC.
106 Lafayette St. • New York 13, N. Y.

The RADIO AMATEUR Newcomer

... JUST OUT!

The only comprehensive book for the beginner!

YOU need no other book to get your license and get on the air. Ideal for those just getting started, or getting interested, in amateur radio.

ABSOLUTELY COMPLETE

- How-to-build simple equipment for a complete station on all newcomer bands.
- Operating instructions.
- Simple theory.
- Complete section of study questions, including those needed to pass the license exams.
- U. S. A. Amateur radio regulations. Written by those masters of making-it-plain, the editors of the "Radio Handbook" and the prewar "Radio."

\$1.00 at your dealer
or \$1.10 postpaid from us

READY, Winter 1947-1948

ANTENNA MANUAL

The most comprehensive antenna book yet published, with all the old tried-and-true standards, and many a new one.

Among the new, "hot" antennas described in this book are:

- ✓ The BOBTAIL CURTAIN and the VERTICAL TRIAD, a couple of dx-dandies for 75 and 40.
- ✓ The OCTAPUSH, a single array for 40, 20, and 10!
- ✓ The X-CURTAIN, an improved "Lazy-H."
- ✓ The ELECTROTATOR, an electrically rotated broadside curtain.

WRITTEN BY W. W. SMITH, W6BCX, Editor of the prewar "Radio" and "Radio Handbook". Many of you know him as the developer or first popularizer of the *Lazy-H* array, the *Plumber's Delight* three-element rotary, the *Bi-Square* array, the link-coupled universal antenna coupler, and various other little gems which after many years are still help-

ing hams snag dx, save money, avoid pink tickets for harmonics, and otherwise keep them contented.

The ANTENNA MANUAL has the same happy combination of practical how-to-build-it data and simple underlying explanations that make the "Radio Handbook" one of the largest-selling radio texts in existence.

"Sugar-coated" radiation, propagation, antenna, and transmission line theory help you understand what's going on.

Comprehensive practical data (including dimensions of course) on all the more popular antennas—and on some brand-new ones which have never before appeared in print, but about which you are going to hear a lot on the air in the near future.

A general antenna text, not exclusively for the ham. Antenna techniques and propaganda data are given for all frequencies between 16 kc. and 1000 Mc., regardless of application.

Tentative price, \$3.00, durably clothbound.

Reserve your copy now from your favorite dealer, or direct from us; please add 10c to U.S.A. mail orders; foreign, 25c.

THE WORLD'S RADIO TUBES

COMPLETE--In Twelve Languages

So extensive is the sale of this book, and so thorough is the coverage of tubes made in all nations, that this book is published in twelve languages!

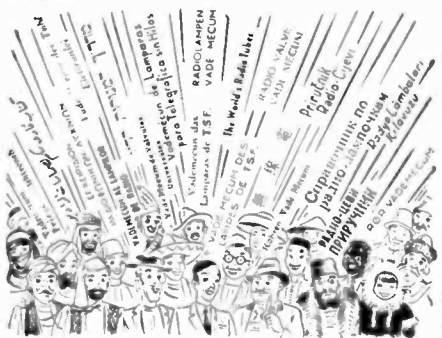

▶ GET YOUR COPY NOW AT YOUR FAVORITE DEALER'S, or direct by mail from us, at \$3.00. Please add 10c to U.S.A. mail orders; foreign 20c.

(Customers outside the Americas should send orders or inquiries on this book to P. H. Brans, Ltd., 28 Prins Leopold St., Borgerhout, Antwerp, Belgium. Price, 135 Belgian francs per copy.)

("Radio Tube Vade Mecum")

More than 10,000 tubes listed!

New "1948" Seventh Edition NOW READY

The Only Book of Its Kind in the World—and one of the world's largest-selling radio books.

CHARACTERISTIC TUBE DATA OF

- U. S.
- BRITISH
- FRENCH
- CZECH
- SWISS
- AUSTRALIAN
- GERMAN
- ITALIAN
- RUSSIAN
- JAPANESE
- SCANDINAVIAN

and all other available types.

More listings than ever before • New, larger page size • Better paper and appearance

Of the previous, smaller edition, *Electronics* said: "Here at last is the radio tube handbook radio engineers have dreamed of . . . in many carefully prepared tables and charts." "Probably the most complete and authoritative set of tube-data in existence," said *Radio Craft*.

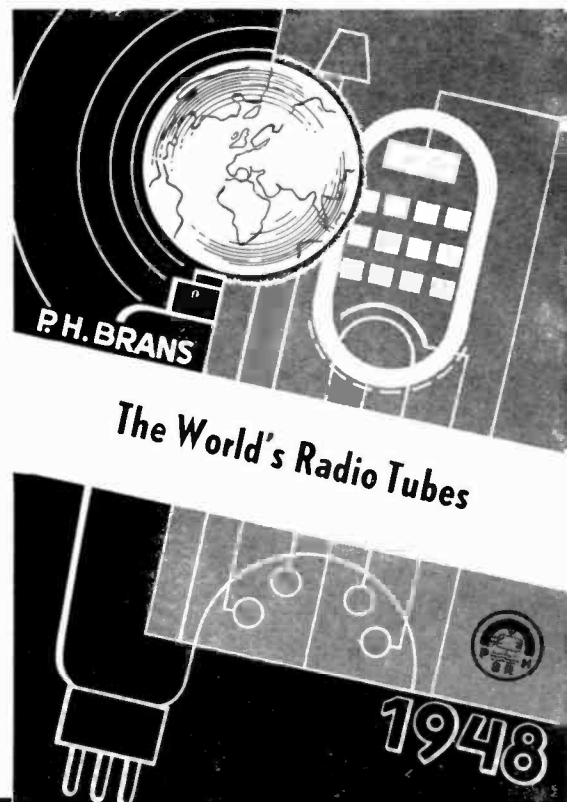

IF YOU DON'T LIVE NEAR OR DEAL REGULARLY WITH ONE OF OUR DEALERS, YOU MAY ORDER DIRECT FROM US BY MAIL. (DEALERS: "technical" discounts allowed on these books when purchased by the radio, book, and news trades in quantities for resale.)

Editors and Engineers LIMITED

1300 KENWOOD ROAD

Santa Barbara CALIFORNIA

BOOKS ON RADIO AND ALLIED SUBJECTS

(Continued from page 5)

UNDERSTANDING MICROWAVES, by V. J. Young. The title explains the purpose of this book, one of the most understandable which we have seen among those which explore microwaves with reasonable thoroughness; well illustrated, with a minimum of mathematics. 385 pages. Book No. YU40 \$6.00*

OPERATING PRACTICE— Commercial and Aeronautical

RADIO OPERATING QUESTIONS AND ANSWERS, by A. R. Nilson and J. L. Hornung. A practical study guide of the question-and-answer type useful for preparing for any of the radiotelegraph, radiotelephone, or amateur operator license examinations. 415 pages. Book No. NQ10 \$3.50*

PRACTICAL RADIO COMMUNICATION, by A. R. Nilson and J. L. Hornung. A complete radio manual covering subjects of interest particularly to the commercial radio operator. Topics include basic electricity; transmitters, receivers, and associated apparatus; and operating instructions. FM and ultra-high frequencies are included in this new edition. May be mastered by the average high school or trade school student. 927 pages. Book No. NC10 \$6.50*

RADIO CODE MANUAL, by A. R. Nilson. This book gives 20 lessons on sending and receiving radio code signals, and messages. It contains selected practice material for use with code practice sets (construction of which is described) and gives a resume of rules and regulations governing radio operators. 174 pages. Book No. NC11 \$2.75*

HOW TO PASS RADIO LICENSE EXAMINATIONS, by C. E. Drew. A well illustrated and long-used question and answer manual for the coaching of candidates for the commercial radiotelegraph and radiotelephone operator license examinations. 320 pages. Book No. DH20 \$3.25*

THE RADIO MANUAL, by G. E. Sterling. A comprehensive and practical handbook written especially for commercial and broadcast operation. Covers not only principles and methods but also a wide variety of apparatus. 1120 pages. Book No. SM30 \$6.50*

RADIO SERVICING

PRINCIPLES AND PRACTICE OF RADIO SERVICING, by H. J. Hicks. Explains operating principles of radio circuits and service test equipment, and outlines methods of shooting trouble in radio receivers and making repairs. A good book for the radio man anticipating entry into his own repair business. 391 pages. Book No. HS10 \$4.00*

RADIO SERVICE TRADE KINKS, by L. S. Simon. A manual for radio service men, quick reference to common radio ailments and their correction. The direct method of presenting the trouble and the remedy, makes this a valuable book for those who repair radios on a practical commercial basis. 254 pages. Book No. SK10 \$3.50*

CATHODE RAY PATTERNS, by Merwyn Bly. Cathode ray patterns for technicians who need the drawings quickly. A "sketch-and-caption" summary of cathode ray pattern types encountered in laboratory and test bench work. Contains over 100 charts of common occurrence, and a minimum of text matter. 39 pages. Book No. BP20 \$1.75*

STARTING AND OPERATING A PROFITABLE RADIO BUSINESS, Coyne. Down-to-earth facts on what to do and what not to do to run a profitable full time or part time shop of your own. Ideas that mean money to you. 180 pages. Book No. CB80 \$1.75*

MODERN RADIO SERVICING, by A. A. Ghirardi. A complete radio servicing reference library in one volume. It is designed particularly for those who wish to enter radio service work, but it is also used by those already in such work to add to their fundamental knowledge and to bring their methods up to date. Also includes hints on sales and merchandising methods. 1300 pages. Book No. GS60 \$5.00*

RADIO TROUBLESHOOTER'S HANDBOOK, by A. A. Ghirardi. A time saving data handbook containing tabulated service data of all kinds; contains symptoms and remedies for common troubles in more than 4800 receivers and record changers; ignition-service interference data for more than 80 cars; comprehensive tube charts, resistors and condenser tables; color codes, trade directories etc. 744 pages. Book No. GT60 \$5.00*

BOOKS BY JOHN F. RIDER: AUTOMATIC RECORD CHANGERS AND RECORDERS. 744 pages. Book No. RC40 \$9.00*

VACUUM TUBE VOLTMETERS. 180 pages. Book No. RV40 \$2.50*

SERVICING BY SIGNAL TRACING. Covers thoroughly the only method of locating difficulties applicable to all types of electrical communications systems, both of audio and radio frequencies. 360 pages. Book No. RT40 \$4.00*

FREQUENCY MODULATION. A general discussion with special attention to f.m. receiver and maintenance problems. 136 pages. Book No. RF40 \$2.00*

THE METER AT WORK. 152 pages. Book No. RM40 \$2.00*

THE OSCILLATOR AT WORK. 256 pages. Book No. RO40 \$2.50*

THE CATHODE RAY TUBE AT WORK. The leading practical work on the many common service and other applications of the c.r. tube in oscillographs. 388 pages. Book No. RC41 \$4.00*

INSIDE THE VACUUM TUBE. 407 pages. Book No. RV41 \$4.50*

SERVICING SUPERHETERODYNES. 307 pages. Book No. RS40 \$2.00*

AUTOMATIC FREQUENCY CONTROL SYSTEMS. 144 pages. Book No. RC42 \$1.75*

SERVICING RECEIVERS BY MEANS OF RESISTANCE MEASUREMENT. 203 pages. Book No. RM41 \$2.00*

D. C. VOLTAGE DISTRIBUTION IN RADIO RECEIVERS. 96 pages. Book No. RD40 \$1.25*

ALTERNATING CURRENTS IN RADIO RECEIVERS. 96 pages. Book No. RA40 \$1.25*

RESONANCE AND ALIGNMENT. 96 pages. Book No. RR40 \$1.25*

AUTOMATIC VOLUME CONTROL. 96 pages. Book No. RV42 \$1.25*

F. M. AND TELEVISION

PRINCIPLES OF TELEVISION ENGINEERING, by D. G. Fink. Designed to give the reader information on the fundamental processes of television reception and transmission; and to supply design data and descriptions of modern equipment. It covers the television system completely from camera in the studio to viewing screen at the receiver. 541 pages. Book No. FT10 \$5.50*

F.M. SIMPLIFIED, by M. S. Kiver. Construction, operation, installation, servicing of F.M. transmitters and receivers. A practical simplified text. Book No. KF30 \$6.00*

FREQUENCY MODULATION, by August Hund. A textbook of FM engineering. Compares amplitude, phase, and frequency modulation and covers FM transmitters, receivers, and antennas. 375 pages. Book No. HM10 \$4.50*

TELEVISION, by V. K. Zworykin and G. A. Morton. A complete treatise on electron optics and television transmission and reception, interspersed with occasional mathematics including calculus. 646 pages. Book No. ZT21 \$7.00*

TELEVISION SIMPLIFIED, by Milton S. Kiver. A simplified explanation of modernized television, especially as it pertains to the operation and maintenance of television receivers. A "simple language" text readily understood by those with fair radio knowledge. 432 pages. Book No. KT30 \$6.00*

RADAR

PRINCIPLES OF RADAR, by M.I.T. Staff. The recognized authority on radar. This complicated subject is presented in an unusually lucid manner; much of the information is practical; explanations are not excessively mathematical. 887 pages. Book No. MR10 \$5.00*

RADAR SYSTEMS ENGINEERING, by L. N. Ridenour (Editor). First of the 28-volume M.I.T. series from M.I.T. Radiation Lab. A general treatise and reference on the design of radar systems, especially microwave pulse radar. Detailed discussions of important components and ancillary techniques. 748 pages. Book No. RE10 \$7.50*

RADAR ENGINEERING, by D. G. Fink. A practical handbook to acquaint radio engineers with the new techniques used in radio detecting and ranging. Theory and practice; various systems; technical detail of design. 644 pages. Book No. FR10 \$7.00*

HANDBOOKS AND REFERENCE DATA

RADIO ENGINEERING HANDBOOK, by Keith Henney and Others. An extensive reference book

prepared by 28 specialists. Contains abundant explanatory material, diagrams, formulas, and tables in each branch of the radio field. 945 pages. Book No. HH10 \$6.00*

RADIO ENGINEER'S HANDBOOK, by F. E. Terman. The wealth of technical data contained in this handbook makes it indispensable as a complete reference work on radio and electronics. Charts, tables, circuit diagrams, and concise text material simplify the solution of complex, as well as simple problems. 1019 pages. Book No. TH10 \$7.00*

RADIOTRON DESIGNER'S HANDBOOK. This book by the Australian Radiotron people contains more useful handbook-type information in its 352 pages than any U.S.A. radio book. Tabular and mathematical data are accompanied by more explanatory data than is customary in such books. Thirteen chapters on a.f. 8 on r.f., and several on rectification, receivers, tests and measurements, tube characteristics, general theory and miscellaneous. 352 pages. Book No. RD80 \$1.25*

REFERENCE DATA FOR RADIO ENGINEERS. This book by the "Federal Radio" people is less comprehensive than some of the other books listed in this section but it contains the information most often needed by radio engineers in concise and inexpensive form. Book No. FDB0 \$2.00*

STANDARD HANDBOOK FOR ELECTRICAL ENGINEERS, by A. E. Knowlton and a staff of specialists. This 2303-page volume is the leading reference work for electrical engineers. Prepared by a staff of over 100 specialists, it contains 26 sections covering every phase of electrical engineering from units and conversion factors to electrophysics. 2303 pages. Book No. KH10 \$9.00*

ELECTRICAL ENGINEER'S HANDBOOK (Communications & Electronics Volume), by Harold Pender and Staff. This is a complete and well organized collection of engineering and mathematical data for communications and electronic engineers. Numerous tables, charts, circuits and illustrations. 1022 pages. Book No. PH20 \$6.00*

ELECTRICAL AND RADIO DICTIONARY, Coyne. Vest pocket size book over 3300 electrical, radio, radar and atomic energy terms. 3" x 6" vest pocket size, leatherette binding. 300 pages. Book No. CD80 \$1.00*

ELECTRICIAN'S HANDBOOK, Coyne. Latest electrical rules, codes, methods—shop hints—shortcuts. This book is a "must" for the practical electrician, saves time and guesswork on wiring, motors, power plants, batteries illumination, packed with facts. 400 pages. Book No. CHB0 \$2.75*

ELECTRONICS DICTIONARY, by N. M. Cooke and John Markus. A well illustrated cyclopedia of more than 6000 radio and electronic terms from A to z one police station. The definitions are as brief as practicable without sacrifice of accuracy, completeness and clarity. Lists latest terms. 433 pages. Book No. CD10 \$5.00*

MISCELLANEOUS

MEASUREMENTS IN RADIO ENGINEERING, by F. E. Terman. This book explains completely the accepted methods of making all types of radio tests and measurements. Its scope is wide and its treatment of the subject thorough, and it makes liberal use of circuit diagrams charts and other illustrations. 400 pages. Book No. TM10 \$4.50*

LABORATORY MANUAL AND RADIO FUNDAMENTAL PRINCIPLES AND PRACTICES, by Almstead, Davis and Stone. Carefully selected and well-planned experiments for a high school course in fundamentals of radio. Fundamental Principles and Practices in Radio. Follows the New York State Syllabus (also prepared by the author). Book No. AM10 \$1.00*

CUSTOM BUILDING SERVICE

• Our laboratory staff is prepared to custom-build a limited amount of equipment for those who do not have the time or inclination to build their own.

Equipment shown in this book can be duplicated at minimum cost, or if preferred we'll design and build to meet your requirements at a moderate extra charge for engineering and design service. (Note: we have no facilities for quantity production).

LABORATORY MODELS FOR SALE

• The laboratory model of many of the units shown in this book is for sale at a reasonable price. Write promptly regarding those in which you are interested.

INDEX

A

Absorption type Wavemeter.....	421
A-C Generator.....	22
Acorn Tubes (See Receiving Tube Charac- teristics).....	205
Adjustment of Crystal Oscillators.....	159
Adjustment of Receivers.....	88
Adjustment of Transmitters.....	159
Aerial (See Antennas)	
Air Gap, Filter Choke.....	356
Air Gap, Tuning Capacitor.....	106
Alignment Chart, Coil Calculation.....	202
Alignment, Receiver:	
I-F Stages.....	89
Superheterodyne.....	89
R.F. Stages.....	89
Alternating Current.....	21
Alternator.....	22
Amateur Licenses.....	8
Ampere, Definition.....	15
Amplification.....	43
Amplification Factor (Mu).....	43
Amplifiers:	
Audio Frequency Voltage Amplifiers.....	45
Audio Frequency Power Amplifiers.....	50
Calculation of Class C R-F Amplifiers.....	58
Cathode Follower.....	45, 54, 64
Classes of Amplifiers:	
Class A.....	45
Class A ₁	45
Class A ₂	45
Class AB ₁	45
Class AB ₂	45
Class B.....	45, 62, 96
Class B Linear.....	96, 118
Clipper-filter.....	131
Feedback.....	64
Grounded Grid.....	45, 62
Phase Inverters.....	49
Power (See Power Amplifiers)	305
R-F Power.....	58
Tuned R-F Voltage.....	56
V-H-F.....	112
Video Frequency.....	65
Efficiency.....	51, 53, 59, 61
Excitation.....	60, 63
I-F.....	77
Inverse Feedback.....	64
Load Impedance.....	54, 61, 120
R-F, Neutralization.....	97
R-F, Tank Circuit Capacitances.....	103
Speech (See also Modulators).....	127, 333
Standard Push-Pull Circuit.....	308
Amplitude Modulation.....	113
Systems.....	115
Angle of Plate Current Flow.....	58, 61
Anode Materials.....	37, 102
Antennas:	
Angle of Radiation.....	171, 176, 388, 394
Bandwidth.....	172, 177
Broadside Arrays.....	390, 405
Broadside Radiation.....	405
Characteristics & Considerations.....	172
Coaxial Line.....	181
Colinear.....	389
Corner Reflector Design Data.....	399
Counterpoise.....	377
Coupling to Transmitter.....	163
Current Fed.....	185
Delta Match.....	376, 404
Diamond (See Rhombic).....	387
Dipole.....	373
Directional Arrays.....	408
Aperiodic Long Wire.....	385
Broadside.....	390, 405
Close Spaced.....	391, 401
Colinear.....	389
Double Extended Zepp.....	390
Franklin.....	389
H Array.....	390, 398, 405
Kraus Flat Top.....	391
Loop.....	189
Parasitic.....	401
Rhombic.....	387
Stacked Dipole.....	388
Sterba Curtain.....	390
Three-Element Rotary.....	401
Directivity.....	172, 390
Doublet.....	375
Doublet, Two-Wire.....	374
Doublet, Multi-Wire.....	183, 375
Dummy.....	383
Efficiency.....	175
End Fed.....	379
Extended Double Zepp.....	390

Feed Systems.....	178, 403, 406
Folded Dipole.....	375, 403
Four-Wire R-F Transformer.....	380
Franklin.....	389
Fuchs.....	573
Gain.....	172, 401
Ground Connection.....	378
Ground Effect.....	174
Ground Resistance.....	175
Guy Wires.....	382
Half-Frequency Operation.....	378
Half-Wave.....	375
Harmonic Resonance.....	173
Harmonic Radiation Suppression.....	166
Hertz.....	373
Horizontal Pattern vs. Vertical Angle.....	384
Impedance.....	382
Insulation.....	400
J Type.....	391
Kraus Flat-Top Beam.....	374
Length.....	172, 374
Linear R-F Transformer.....	186
Loading Coils.....	377
Loading of Transmitter.....	163
Long-Wire Directive Antennas.....	385
Loop.....	189
Marconi.....	373
Masts, Rotatable.....	413
Mobile.....	400
Multiple Stacked.....	399
Multi-Band.....	379
Phased.....	388
Polarization.....	172, 396, 408
"Plumber's Delight".....	406
Q Sections.....	286
Radiation Resistance.....	172
Receiving.....	188
Rhombic.....	387
Rotary (Rotatable).....	401
Servo Mechanisms.....	414
Single-Wire Fed.....	184
Stacked Dipole Arrays.....	388
Standing Waves on Feeder.....	179
Stubs.....	184
T Match.....	404
Transmission Lines.....	395
Coaxial Line.....	181
Four-Wire Open Line.....	180
Non-resonant Line.....	182
Twinned.....	378, 380, 404
Two-Wire Open Line.....	180
V Type.....	386
Vertical.....	397
Vertical Angle.....	385
Wavelength.....	396
Wire.....	382
WVJK Array.....	391
Zepp.....	390
Application for Licenses.....	8
Arithmetical Selectivity.....	69
Audio Frequency Amplifiers (See Ampli- fiers)	
Audio Frequency Impedance Matching.....	54, 120
Audio Oscillator, Wide Range.....	439
Autodyne Detector.....	67
Autotransformers.....	33
Automatic Volume Control.....	80
Automatic Peak Limiting (Clipping).....	131
Average D-C Value.....	24

B

Bandpass Circuits (See I-F Amplifiers).....	77
Bandspread.....	74
Bandswitching Exciter.....	292
Bandswitching V.F.O. Unit.....	297
Barrage Array, Sterba Curtain.....	390
Bass Suppression.....	130
Beam Power Amplifiers.....	50, 314
Beam Power Stages, Parasitic Elimination.....	162
B.F.O.....	79
B-F-O Adjustment.....	79
Bending Ends of Antenna.....	378
Bias.....	108
Automatic.....	108
Battery.....	108
Cathode.....	108
Considerations.....	108
Cutoff.....	38
Grid Leak.....	108
Supplies.....	349
Transmitter.....	108
Voltage Regulated.....	349
Bleeder Resistor.....	347
Block Grid Keying.....	137
Breakdown Ratings of Capacitors.....	346

Bridge Rectification.....	342
Bridges.....	420
Transmission Line.....	424
Wheatstone.....	419
Broadband Converters.....	280
Broadcast Interference.....	195
Butterfly Circuit.....	86, 282
Buyer's Guide.....	449

C

Cable, Coaxial.....	181
Calculation of Class B Power Amplifiers.....	52
Calculation of Class C Operating Condi- tions.....	58
Calibration (See Measurements)	
Capacitance:	
Calculation of.....	27
Interelectrode.....	84
Tank Circuit.....	103
Unit of.....	26
Carbon Microphone.....	125
Cathode.....	35
Cathode Bias.....	108
Cathode, Heater Type.....	36
Cathode Follower.....	45, 54, 64
Cathode Ray Oscilloscope.....	426
Cathode Ray Tubes (Characteristics).....	240
Cavity Resonator.....	85, 282
Characteristic Impedance.....	180
Characteristics of Vacuum Tubes:	
Receiving Tubes.....	205
Transmitting Tubes.....	245
Charts:	
Capacitance Required to Resonate a Line.....	85
Choke Design (Filter).....	356
Coil Calculator Nomograph.....	202
Continental Code.....	8
Copper Wire Table.....	355
Flat-Top Beam Design Data.....	392
Folded Dipole.....	403
Long Antenna Design.....	386
Parasitic Array Design.....	402
Reactance Frequency Chart.....	203, 204
Resistor Capacitor Color Code.....	201
Resistivity.....	15
Transformer Design.....	353
Tube Tables:	
Receiving Type.....	205
Transmitting Type.....	245
Wavelength versus Frequency.....	396
Choke Considerations.....	356
Choke, Core Material.....	25
Choke Design.....	356
Choke, R-F.....	110
Choke, Smoothing.....	357
Choke, Swinging.....	357
Circuit Q.....	30, 104
Circuit, Resonant.....	30
Circulating Tank Current.....	32
C/L Ratios.....	32
Class A Amplifier.....	45
Class A Modulator.....	50
Class AB Amplifier.....	45
Class B Amplifier.....	45, 62, 96
Class B Modulators.....	52
Class C Amplifiers.....	58
Class C Bias.....	108
Class C Grid Modulation.....	116
Classes of Vacuum Tube Amplifiers.....	45
Clipper Circuits.....	134
Clipper Filter Circuits.....	340, 437
Clypter.....	54
Coaxial Lines.....	86
Code:	
Continental.....	8
Practice Oscillator.....	13
Coefficient of Coupling.....	57
Colinear Antennas.....	389
Collins Antenna Coupler.....	163
Colpitts Oscillator.....	91
Compact Antennas.....	378
Conductors.....	16
Conversion Conductance.....	44
Conversion, Double.....	73, 270
Converter Circuit.....	71, 276
Converter Tubes.....	71
Copper Wire Tables.....	255
Core Material.....	25
Core Saturation.....	356
Core Size.....	356
Coulomb, Definition.....	15
Coupling:	
Antenna to Receiver.....	56
Antenna to Transmitter.....	163
Capacitive.....	109

Coefficient of.....	57
Inductive.....	109
Interstage.....	47, 57, 109
Link.....	109, 183
Methods.....	47, 48, 49, 109
Resistance Capacitance.....	45
Cross Modulation.....	196
Crystal:	
Action in I-F Amplifier.....	78
AT Cut.....	93
Axes.....	93
Calibrator.....	367, 422
Filters.....	78
Microphone.....	126
Oscillator Tuning Procedure.....	95
Oscillators.....	94
Rectifiers.....	38
Temperature Effects.....	94
Current:	
Alternating.....	21
Direct.....	21
Feed for Antenna.....	185
Flow in Bias Supply.....	349
Cutoff Bias.....	38
Cutoff Frequency (for Filters).....	34

D

Decibels.....	202
Decibel Calculations, Speech Amplifier.....	202
Degenerative Feedback.....	64, 129
Delta Matched Antenna.....	376, 404
Demodulation.....	66
Detectors.....	66
Audio Modulated.....	80
Autodyne.....	67
Diode.....	80
FM.....	147
Second (Superheterodyne) Superegenerative.....	80
Superegenerative.....	67
Deviation.....	140
Deviation, Measurement.....	141
Deviation Ratio.....	140
Dielectric Constant.....	26
Diodes.....	38
Barrier Layer.....	38
Copper Oxide.....	38
Dry Disc.....	38
Galena.....	38
Germanium.....	38
Selenium.....	38
Silicon.....	38
Diode Type Field Strength Meter.....	423, 424
Dipole Antennas.....	375
Direct Current.....	21
Direction Finding.....	189
Directive Antennas.....	384
Discharge, Glow Tubes.....	347
Discriminator, Travis.....	147
Discriminator, Foster-Seely.....	147
Distortion in Modulated Amplifiers.....	135
Distributed Capacitance.....	76
Dividers, Voltage.....	18
Doherty Linear Amplifier.....	123
Double Conversion.....	73, 270
Double Extended Zepp.....	390
Doublers:	
Angle of Plate Current Flow.....	102
Bias.....	102
Push-Push.....	103
Tube Requirements.....	102
Doublet Antenna.....	375
Drift, Frequency.....	92
Drill Sizes.....	192
Driving Mechanisms, Antenna Rotating.....	414
Driving Power, R-F Grid.....	60, 63, 150
Dry Electrolytic Capacitors.....	346
Dummy Antennas.....	383
Dynamic Microphone.....	127
Dynatron.....	92

E

E-C Oscillator Harmonics in Superhets.....	70
Eddy Current Losses.....	25, 356
Effect of Average Ground on Antenna Radiation.....	177
Effect of Coupling on Q.....	104
Effect, Piezoelectric.....	93
Effective Values.....	24
Efficiency, Amplifier.....	51, 53, 59, 61
Efficiency Modulation.....	115
Efficiency, Plate.....	51, 53, 59, 61
Electric Charge.....	15
Electric Power.....	19
Electrical Length.....	172
Electrical Units.....	14
Electrolytic Capacitors.....	28

Electromagnetism.....	20
Electromagnetic Radiation.....	167
Electromagnetic Storage of Energy.....	24
Electromotive Force.....	14
Electron-Coupled Oscillators.....	21
Electron-Ray Tube Uses.....	81
Electrostatic Storage of Energy.....	25
Elements, Rotatable Antenna.....	402
Elimination of Harmonic Radiation.....	166
Elimination of Broadcast Interference.....	195
Emergency C-W Receiver.....	269
Emission Secondary.....	39
Emission, Thermionic.....	35
Emitters, Types of.....	35
End-Fed Antennas.....	373
End-Fire Directivity.....	390
Excitation, Grid.....	161
Exciters and Low-Powered Transmitters.....	90, 287
Exciters:	
7C5/807 Transmitter Exciter.....	288
6L6/809 Transmitter Exciter.....	290
807/11Y-69 Bandswitching Exciter.....	292
Operating-Table V-F-O Exciter.....	293
Six-Band Bandswitching V-F-O.....	297
3.5-Mc. V-F-O Exciter.....	299
Narrow-Band FM Exciter Unit.....	300
150-Watt All-Band Exciter Transmitter.....	302

F

Fading.....	171
Farad, Definition.....	6
Faraday Screen.....	188
Feed:	
Series.....	110
Shunt (Parallel).....	110
Voltage (of Antennas).....	379
Feedback, Degenerative.....	64, 129
Feedback, Inverse.....	64, 129
Feeder Losses.....	180
Feeders, General (See Transmission Lines).....	179
Feeding the Antenna.....	425
Field Strength Meter.....	35
Filament.....	36
Filament Reactivation.....	345
Filters, Power Supply.....	33
Filters, Electric Wave.....	135
Filters, High Level Audio.....	137
Filters, Key Click.....	34
Filters, Pi Section.....	78
Filters, Variable Selectivity Crystal.....	391
Flat-Top Beam.....	374
Flat-Top Length Zepp Antenna.....	139, 285
FM.....	141
Bandwidth.....	147
Discriminators.....	148
Limiters.....	149
Pulse Modulation.....	146
Reception.....	143
Stabilization.....	140
Terms.....	180
Four-Wire Q Sections.....	92
Franklin Oscillator.....	101
Frequency Multipliers.....	13, 319, 394
Frequency Spectrum.....	92
Frequency Stability.....	

G

Gain:	
Audio Frequency, Calculation.....	45
Decibels.....	202
Tube.....	45
Voltage.....	45
Glow Discharge Regulators.....	347
Grid Bias.....	108
Grid Bias Modulation.....	97, 116
Grid Bias Pack Considerations.....	349
Grid Detection.....	67
Grid Excitation.....	161
Grid Leak.....	67, 108
Grid Modulation (See Modulation).....	44
Grid-Screen Mu Factor.....	168
Ground-Wave Propagation.....	101, 273
Grounded Grid Amplifiers.....	

H

H Antenna.....	405
Half-Wave Radiators.....	375
Half-Wave Rectification.....	342
Harmonic-Cut Crystals.....	94
Harmonic Radiation.....	104
Harmonic Suppression.....	166
Hartley Oscillator.....	90
Hazeltine Neutralization.....	98
Heater Cathode.....	36

Heating Effect.....	20
Heising Modulation.....	119
Henry (Unit of Inductance).....	24
Hertz Antenna.....	373
High-Frequency Chart.....	161
High-Frequency Converters.....	276
High-Powered Amplifiers.....	305
Horizontal Pattern versus Vertical Angle.....	384
Horizontal versus Vertical Antennas.....	172, 396, 408
Hysteresis.....	356

I

I-F Amplifier.....	77
I-F Amplifier Alignment.....	77
I-F Amplifier Noise Silencer.....	83
I-F Tuned Circuits.....	77
Images.....	72
Impedance Definition.....	31
Impedance:	
Antenna.....	174
Characteristic Surge.....	179
Coupling.....	109
Matching (A-F Circuits).....	54, 61, 129
Matching (Antennas).....	182, 409
Receiver Input Matching.....	56
Transmission Line.....	179
Inductance, Definition.....	24
Inductance:	
Calculation.....	202
Mutual.....	24
Self.....	24
Unit of.....	24
Induction.....	22
Inductive Coupling.....	109
Input Choke Filter.....	345
Input Capacitor Filter.....	345
Input Resistance of Vacuum Tubes.....	56
Insulation.....	152
Insulators.....	15
Interelectrode Capacitances.....	44
Interference, Broadcast.....	195
Intermediate Frequency (See I.F.).....	
Interruption Frequency.....	67
Interstage Coupling.....	109
Inverse Feedback.....	129
Inverse Peak Voltage.....	344
Inversion, Temperature.....	169
Inverter, Phase.....	49, 128
Ionosphere.....	171

J

J Antenna.....	400
Jacks, Meter.....	152
Johnson Q Bars.....	375
Joule.....	24

K

Key Click Filters.....	136
Keying Methods.....	113, 136
Kirchhoff's Laws.....	19
Klystron Oscillator.....	112
Kraus Flat-Top Beam.....	391

L

Law, Kirchhoff's.....	19
Law, Ohm's.....	16
Layer Heights, Ionosphere.....	171
Lazy H Antenna.....	405
L-C Circuits.....	32
L/C Ratio.....	32
Lead and Lag of Current.....	28
Learning the Code.....	8
Lecher Wires.....	289
License, Amateur.....	8
Limiter, Audio Systems.....	131
Limiter, FM.....	148
Limiter Circuits (Noise).....	83
Line, Transmission.....	395
Line-Controlled Oscillators.....	113
Linear Amplifier.....	118
Linear Amplifier, Doherty.....	123
Linear Tank Circuits.....	85
Linear Transformers (Antenna).....	186
Linearity of Class C Amplifiers.....	121, 135
Link Coupling.....	110, 164
Load Matching.....	20
Loading, Effect upon Q.....	104
Long-Wire Radiators.....	385
Loop Antenna.....	189
Loss, Decibel.....	202
Losses, Eddy Current.....	356
Losses, Feeder.....	180

Losses, Hysteresis.....	356
Low-Frequency Parasitics.....	107
Low-Pass Filters.....	200
Low-Power Transmitters and Exciters.....	287

M

Magnetic Circuit.....	21
Hysteresis.....	21
Flux.....	21
Magnetic Fields.....	20
Magnetomotive Force.....	21
Permeability.....	21
Reluctance.....	21
Retentivity.....	21
Residual Magnetism.....	21
Saturation, Magnetic.....	21
Magnetrons.....	112
Marconi Antenna.....	373
Masts, Rotatable.....	413
Matched Impedance Lines.....	182
Matching Stubs.....	184
Matching Transformers.....	186
Matter, Composition of.....	14
Maximum Usable Frequency (MUF).....	170
Measurements:	
Alternating Current and Voltage.....	416
Capacitance.....	419
Current.....	415
Frequency.....	284, 328, 421
Inductance.....	419
Modulation.....	114
Power.....	415, 418
Q.....	419
Resistance.....	415
Voltage.....	415
Medium and High Power Amplifiers.....	305
Memorizing the Code.....	9
Mercury Vapor Rectifiers.....	345
Meters, Field Strength.....	425
Metering Transmitter Circuits.....	152
Microphones.....	124
Miller Effect.....	78
Mixer Circuits.....	69, 282
Mixer Noise.....	72
Mobile Antennas.....	400
Modulation.....	139
Modulation:	
Amplitude.....	113
Cathode.....	122
Circuits for FM.....	141
Class A.....	119
Class B Plate.....	119
Class C Grid.....	116
Cross.....	196
Doherty and Terman-Woodyard.....	123
Efficiency (Variable).....	115
Frequency.....	274, 300
Grid.....	97, 116
Heising.....	119
Monitor.....	423, 427
Peaks.....	114
Percentage.....	114
Phase.....	144
Plate.....	97, 119
Plate and Screen.....	121
Reactance Tube.....	141
Screen Grid.....	118
Sidebands.....	113
Splatter Suppressor.....	133
Suppressor Grid.....	118
Transformers.....	120
Tube Combinations.....	53
Modulation Transformer Calculation.....	54, 120
Monitor, Amplitude Modulation.....	423, 427
Mu (Amplification Factor).....	43
Multi-Band Antennas.....	379
Multi-Band Exciters.....	292
Multi-Wire Doublet Antennas.....	183, 375
Multi-Wire Transmission Lines.....	180
Mutual Conductance, Transconductance.....	43
Mutual Inductance.....	24

N

Narrow-Band Frequency Modulation (NBFM).....	274, 300
Negative Grid Oscillators.....	90
Negative Resistance.....	279
Negative Resistance Oscillators.....	92
Neutralization of R-F Amplifiers.....	45, 97
Neutralization Procedure.....	99
Noise Balancing Systems.....	82
Noise Factor of Receivers.....	56
Noise, Internal.....	56
Noise Limiter Circuits.....	83
Noise, Mixer.....	72
Noise, Ratio.....	56

Noise Silencers.....	83
Noise Suppression.....	82
Non-resonant Lines.....	179

O

Ohm's Law.....	16
Ohmmeter.....	415
Open Wire Lines.....	179
Optimum Angle of Radiation.....	176
Oscillation:	
Frequency of.....	284, 328, 421
Parasitic.....	62, 107, 138, 159, 161
Piezoelectric.....	93
Vacuum Tube.....	90
Oscillator-Multiplier Circuits.....	94, 96
Oscillator-Mixer Circuits.....	70
Oscillators:	
Beat Frequency.....	79
Circuits.....	91
Coaxial Line.....	113
Code Practice.....	13
Colpitts.....	91
Crystal Controlled.....	93
Electron Coupled.....	91
Franklin.....	92
Harmonic.....	95
Hartley.....	90
Hot Cathode Colpitts.....	290, 302, 362
Interruption Frequency.....	67
Klystron.....	112
Magnetron.....	112
Negative Resistance.....	92
Pierce.....	94
Quartz Crystal.....	93
Superregenerative.....	67
Tuned Plate Tuned Grid.....	91
V-H-F.....	92
Variable Frequency.....	90
Wide-Range Audio.....	428
Oscilloscope.....	426
Overload Protection.....	157
Overmodulation.....	196
Oxide Coated Cathodes.....	36

P

Parallel Circuits.....	17
Parallel Circuits, Circulating Current.....	30
Parallel Capacitors.....	27
Parallel Feed of Amplifiers.....	110
Parallel Inductors.....	25
Parallel Inverse Feedback.....	64
Parallel Resistors.....	17
Parallel Resonance.....	32
Parallel Resonance, Circulating Current.....	32
Parallel Tube Circuits.....	107
Parasitic Oscillations.....	62, 107, 138, 159, 161
Parasitic Suppression.....	161
Pass Band.....	77
Patterns, Radiation (See Antennas).....	
Peak Current.....	344
Peak Inverse Voltage.....	344
Peak Limiters.....	131
Peak Power.....	59
Peak Values.....	24
Pentagrid Converter.....	69
Pentode Amplifiers.....	57
Percentage Modulation.....	114
Permeability.....	21
Phantom Signals.....	197
Phase.....	28
Phase Inverters.....	49, 128
Phase Modulation.....	144
Phase Shift.....	129
Phased Antennas.....	388
Pi Section Antenna Coupler.....	163
Pi Section Filter.....	34
Pierce Crystal Oscillator.....	94
Piezoelectric Effect.....	93
Plate Circuit Efficiency, Class C Stage.....	59, 61
Plate Circuit Tuning.....	160
Plate Current, Angle of Flow.....	58, 61
Plate Modulation.....	97, 119
Plate Resistance.....	44
Plate and Screen Modulation.....	121
Plate Spacing, Capacitor.....	106
Polarization, Radio Wave.....	167
Positive Peak Modulation.....	115, 131
Power.....	19
Power Amplifiers.....	305
Power Amplifier:	
Beam Tetrode.....	314, 318
Driving Power.....	151
Excitation for.....	307
Filament Supply.....	305
Grid Bias.....	305
Grid Circuit.....	306

Metering.....	305
Plate Circuit.....	306
Power Factor.....	29
Power Line Filters.....	82
Power Supplies.....	342
Power Supplies:	
Bias.....	349
Bleeder Resistor.....	347
Bridge Rectification.....	342
Control Circuits.....	360
Dynamotors.....	352
Electrolytic Capacitors.....	346
Filter Chokes.....	346
Output Voltage from.....	347
Peak Inverse Voltage.....	344
Peak Plate Current.....	340
Ripple Voltage.....	347
Transformerless.....	350
Vibrator.....	352
Voltage Doubler Circuits.....	350
Practice, Code.....	9
Practice, Workshop.....	190
Preamplifiers (See Speech Equipment).....	
Preselector.....	73
Primary Keying.....	136
Propagation.....	167
Push-Pull Operation.....	111
Push-Pull Doubler.....	103

Q

Q.....	30, 61, 104
Q of Amplifier Tank Circuit.....	61
Q Bars.....	186
Q Matching Section.....	186
Q Signals.....	448
Quarter-Wave Antennas.....	376
Quarter-Wave Line, Electrical.....	124
Quarter-Wave Matching Transformer.....	186
Quarter-Wave Matching Stub.....	184
Quartz Crystals.....	93
Quench Frequency.....	67
Quench Oscillator.....	67

R

R Meters.....	81
Radiation.....	23
Radiation, Angle of.....	171, 176, 388, 394
Radiation Resistance.....	172
Radiation, Suppression of Harmonic.....	166
Radiator, Long Wire.....	385
Radio-Frequency Amplifiers.....	90, 287, 305
Radio-Frequency Chokes.....	110
Radio-Frequency Tank Circuit Calculations.....	103
Radio Receiver Alignment.....	88
Radio Receiver Theory.....	66
Radio Receiver Tube Characteristics.....	205
Radio Wave Propagation.....	167
Radiotelephony Theory.....	113
Reactance, Capacitive.....	27
Reactance-Frequency Chart.....	203, 204
Reactance, Inductive.....	35
Reactivated Thoriated Tungsten Filaments.....	36
Receiver Construction.....	268, 276, 282
Receiver, Superheterodyne.....	68
Receiver, Superregenerative.....	67
Rectifiers:	
Barrier Layer.....	38
Copper Oxide.....	38
Dry Disc.....	38
Full-Wave.....	342
Galena.....	38
Germanium.....	38
Grid-Controlled.....	136
Half-Wave.....	342
Selenium.....	38
Silicon.....	38
Reference Data.....	201
Regeneration.....	67
Regenerative Detector.....	68
Resistance.....	15
Resistivity Table.....	15
Resonance.....	31
Resonant Cavities.....	85
R-F Chokes.....	110
R-F Tank Circuit Calculations.....	103
Rhombic Antennas.....	387
Ripple Voltage.....	347
Root Mean Square (RMS), Definition.....	23
Rotatable Antenna Arrays.....	401

S

S Meters.....	81
Safety Bleeders.....	347
Safety Precautions.....	153, 155
Saturation, Core.....	346